

**Transportstyrelsens föreskrifter och allmänna råd  
om transport till sjöss av förpackat farligt gods  
(IMDG-koden)**



## **Innehåll**

<b>Tillämpningsområde.....</b>	<b>1</b>
<b>Tillämpning av Östersjöavtalet .....</b>	<b>1</b>
<b>Införlivande av IMDG-koden .....</b>	<b>2</b>
<b>Erkännande av utländskt godkännande .....</b>	<b>2</b>
<b>Definitioner .....</b>	<b>2</b>
<b>Särskilda krav .....</b>	<b>2</b>
<b>Provning, kontroll, certifiering m.m. ....</b>	<b>3</b>
<b>Deklaration av farligt gods.....</b>	<b>3</b>
<b>Undantag .....</b>	<b>3</b>
<b>Ikraftträdande- och övergångsbestämmelser .....</b>	<b>4</b>
<b>Bilaga 1. Resolution MSC. 328(90).....</b>	<b>5</b>
<b>Bilaga 2. Resolution MSC. 372(93).....</b>	<b>889</b>
<b>Bilaga 3. Förteckning över läkemedel och medicinsk utrustning .....</b>	<b>1105</b>



## Transportstyrelsens föreskrifter och allmänna råd om transport till sjöss av förpackat farligt gods (IMDG-koden);

**TSFS 2015:66**

Utkom från trycket  
den 11 december 2015

beslutade den 24 november 2015.

**SJÖFART**

Transportstyrelsen föreskriver följande med stöd av 4 kap. 8 § förordningen (1980:789) om åtgärder mot förorening från fartyg, 2 kap. 1 § och 3 kap. 2 och 4 §§ fartygssäkerhetsförordningen (2003:438) samt 15 § förordningen (2006:311) om transport av farligt gods samt beslutar följande allmänna råd.

### Tillämpningsområde

**1 §** Dessa föreskrifter ska tillämpas vid transport till sjöss av förpackat farligt gods på alla fartyg som används till sjöfart inom Sveriges sjöterritorium och på svenska fartyg som används till sjöfart utanför sjöterritoriet.

Dessa föreskrifter gäller inte för

1. fritidsfartyg,
2. transporter med Försvarmaktens örlogsfartyg, transporter som omfattas av 9 § lagen (2006:263) om transport av farligt gods eller transporter som avses i 4 § förordningen (2006:311) om transport av farligt gods,
3. farliga ämnen som är avsedda för fartygets drift eller arbetet ombord, samt
4. handburet farligt gods som passagerare medför, om detta gods är förpackat för detaljhandelsförsäljning och avsett för egen användning samt att befälhavaren bedömer att godset, med hänsyn till dess specifika egenskaper, kan medföras utan att det medför en risk från säkerhets- eller miljösynpunkt.

### Tillämpning av Östersjöavtalet

**2 §** Svenska ro-ro-fartyg i Östersjön, Bottniska viken, Finska viken och inloppen till Östersjön, begränsade i norr av en linje mellan Skagen och Lysekil, samt utländska ro-ro-fartyg på Sveriges sjöterritorium i Östersjön, begränsat i norr av en linje mellan Skagen och Lysekil får, om de uppfyller kraven i Transportstyrelsens föreskrifter och allmänna råd (TSFS 2009:131) om transport av förpackat farligt gods på ro-ro-fartyg i Östersjön (Östersjöavtalet), i stället tillämpa den författningen.

## Införlivande av IMDG-koden

3 § Som Transportstyrelsens föreskrifter ska gälla den internationella koden för transport av förpackat farligt gods (IMDG-koden) som antogs av den internationella sjöfartsorganisationen (IMO) den 24 maj 2002 genom resolution MSC.122(75), i den lydelse som framgår av resolutionerna MSC.328(90) antagen den 21 juni 2012 och MSC.372(93) antagen den 22 maj 2014.

Resolutionernas engelska originaltexter finns i bilaga 1 och bilaga 2 till dessa föreskrifter.<sup>1</sup>

## Erkännande av utländskt godkännande

4 § Förpackningar, behållare och tankar som är godkända i enlighet med IMDG-koden i annan stat som är ansluten till IMDG-koden får användas i Sverige för transport till sjöss av sådant farligt gods för vilket godkännandet gäller.

Tekniska krav i dessa föreskrifter gäller inte för ett fartyg eller dess utrustning om fartyget eller utrustningen

1. lagligen har tillverkats eller har satts på marknaden i en annan medlemsstat inom EU eller i Turkiet, eller

2. lagligen har tillverkats i ett EFTA-land som har undertecknat EES-avtalet.

Om fartyg eller utrustning enligt andra stycket inte uppnår en säkerhetsnivå som är likvärdig med den som garanteras genom dessa föreskrifter, ska de tekniska kraven i dessa föreskrifter gälla.

## Definitioner

5 § I dessa föreskrifter används följande begrepp med nedan angiven betydelse.

*behöriga organ* som definierade i 9 § förordningen (2006:311) om transport av farligt gods

*farligt gods* som definierat i lagen (2006:263) om transport av farligt gods

*fritidsfartyg* fartyg (skepp eller båt) som används endast för sport- och fritidsändamål och som medför högst tolv passagerare

## Särskilda krav

6 § Ett exemplar av MFAG (the Medical First Aid Guide for Use in Accidents Involving Dangerous Goods, MSC/Circ.857) och EmS Guide (the

<sup>1</sup> Övriga språkversioner finns tillgängliga hos IMO.

Emergency Response Procedures for Ships Carrying Dangerous Goods) ska alltid finnas tillgänglig ombord på svenska fartyg som omfattas av dessa föreskrifter.

**7 §** Svenska fartyg som transporterar farligt gods ska ha läkemedel och medicinsk utrustning ombord enligt bilaga 3.

Utländska fartyg vilka är byggda efter den 1 september 1984 ska ha läkemedel och medicinsk utrustning ombord enligt bilaga 3 eller motsvarande som säkerställer en likvärdig säkerhetsnivå.

### **Provning, kontroll, certifiering m.m.**

**8 §** I följande delavsnitt av IMDG-koden ska provning, kontroll, certifiering, eller annan bedömning utföras genom behöriga organ: 4.1.3.6.2, 4.1.4.1 avseende förpackningsinstruktion P200, 4.2.1.7–4.2.1.9.1, 4.2.5.3 TP10, TP16 och TP24, 6.1.1.3 avseende nya förpackningar, 6.1.3, 6.1.4, 6.1.5.1.1, 6.1.5.1.3, 6.1.5.1.5, 6.1.5.1.10, 6.2.1.4–6.2.1.7, 6.2.2.5.2, 6.2.2.6.2, 6.3.2, 6.3.4, 6.3.5, 6.5.2, 6.5.4.1 avseende nya och renoverade IBC-behållare, 6.5.6, 6.6.1, 6.6.3, 6.6.5, 6.7.2- 6.7.5, 6.8 och 6.9.

**9 §** Återkommande kontroll av IBC-behållare och första kontroll efter reparation av IBC-behållare enligt delavsnitt 6.5.4.4 respektive 6.5.4.5 i IMDG-koden, ska utföras av personer som uppfyller kraven i kapitel 22.1 i bilaga S till Myndigheten för samhällsskydd och beredskaps föreskrifter (MSBFS 2015:1) om transport av farligt gods på väg och i terräng (ADR-S).

**10 §** Ett godtagbart kvalitetssystem för rekonditionering av förpackningar enligt delavsnitt 6.1.1.3, reparation av IBC-behållare och efterföljande provning och kontroll respektive återkommande kontroll av IBC-behållare enligt delavsnitt 6.5.4.1 i IMDG-koden ska uppfylla de krav som anges i kapitel 21.6 i bilaga S till Myndigheten för samhällsskydd och beredskaps föreskrifter (MSBFS 2015:1) om transport av farligt gods på väg och i terräng (ADR-S).

### **Deklaration av farligt gods**

**11 §** Deklarationen ska vara skriven på engelska. Vid transport enbart inom Sveriges sjöterritorium samt mellan ort på Gotland och annan svensk ort får godsdeklarationen vara skriven på svenska.

### **Undantag**

**12 §** Transportstyrelsen kan, om det finns särskilda skäl och förutsatt att säkerheten inte äventyras, medge undantag från dessa föreskrifter vid sjötransport av farligt gods inom Sveriges sjöterritorium, om det inte strider mot internationella överenskommelser eller gemenskapsrättslig lagstiftning.

**13 §** Transportstyrelsen kan medge undantag från dessa föreskrifter för fartyg som uppfyller förutsättningarna för att istället få tillämpa

Sjöfartsverkets föreskrifter och allmänna råd (SJÖFS 2007:21) om inrikes transport av förpackat farligt gods till sjöss i fartområde D och E.

***Allmänna råd***

*Uppgifter enligt 1.3.1.3 och 1.4.2.3.4 i IMDG-koden bör bevaras i fem år.*

**Ikraftträdande- och övergångsbestämmelser**

1. Denna författning träder i kraft den 1 januari 2016.
2. Genom författningen upphävs Transportstyrelsens föreskrifter och allmänna råd (TSFS 2013:106) om transport till sjöss av förpackat farligt gods (IMDG-koden).
3. Om det i en föreskrift som har beslutats av Sjöfartsverket hänvisas till Sjöfartsverkets föreskrifter (SJÖFS 2007:20) om transport till sjöss av förpackat farligt gods (IMDG-koden) ska denna hänvisning i stället avse dessa föreskrifter.

På Transportstyrelsens vägnar

MARIA ÅGREN

Mattias Hörnquist  
(Sjö- och luftfartsavdelningen)



**ANNEX 4**

**RESOLUTION MSC.328(90) – ADOPTION OF AMENDMENTS TO THE  
INTERNATIONAL MARITIME DANGEROUS GOODS (IMDG) CODE  
(AMENDMENT 36-12)**

Annex 1

List of Contents, Foreword, Preamble and parts 1 to 7, including appendices A and B



## Contents

	<i>Page</i>
Foreword.....	xi
Preamble .....	xiii
<b>PART 1 – GENERAL PROVISIONS, DEFINITIONS AND TRAINING</b>	
<b>Chapter 1.1 General provisions</b>	
1.1.0 Introductory note .....	3
1.1.1 Application and implementation of the Code .....	3
1.1.2 Conventions .....	4
1.1.3 Dangerous goods forbidden from transport .....	9
<b>Chapter 1.2 Definitions, units of measurement and abbreviations</b>	
1.2.1 Definitions.....	10
1.2.2 Units of measurement .....	18
1.2.3 List of abbreviations.....	24
<b>Chapter 1.3 Training</b>	
1.3.0 Introductory note .....	26
1.3.1 Training of shore-side personnel .....	26
<b>Chapter 1.4 Security provisions</b>	
1.4.0 Scope .....	31
1.4.1 General provisions for companies, ships and port facilities .....	31
1.4.2 General provisions for shore-side personnel .....	31
1.4.3 Provisions for high consequence dangerous goods.....	32
<b>Chapter 1.5 General provisions concerning class 7</b>	
1.5.1 Scope and application .....	35
1.5.2 Radiation protection programme.....	36
1.5.3 Quality assurance.....	36
1.5.4 Special arrangement .....	36
1.5.5 Radioactive material possessing other dangerous properties .....	37
1.5.6 Non-compliance.....	37
<b>PART 2 – CLASSIFICATION</b>	
<b>Chapter 2.0 Introduction</b>	
2.0.0 Responsibilities .....	41
2.0.1 Classes, divisions, packing groups .....	41
2.0.2 UN Numbers and Proper Shipping Names .....	42
2.0.3 Classification of substances, mixtures and solutions with multiple hazards (precedence of hazard characteristics) .....	43
2.0.4 Transport of samples .....	44
2.0.5 Transport of wastes .....	45

	Page
<b>Chapter 2.1 Class 1 – Explosives</b>	
2.1.0 Introductory notes (these notes are not mandatory) . . . . .	47
2.1.1 Definitions and general provisions. . . . .	47
2.1.2 Compatibility groups and classification codes . . . . .	48
2.1.3 Classification procedure . . . . .	50
<b>Chapter 2.2 Class 2 – Gases</b>	
2.2.0 Introductory note . . . . .	56
2.2.1 Definitions and general provisions. . . . .	56
2.2.2 Class subdivisions . . . . .	56
2.2.3 Mixtures of gases. . . . .	57
<b>Chapter 2.3 Class 3 – Flammable liquids</b>	
2.3.0 Introductory note . . . . .	59
2.3.1 Definitions and general provisions. . . . .	59
2.3.2 Assignment of packing group . . . . .	59
2.3.3 Determination of flashpoint . . . . .	61
2.3.4 Determination of initial boiling point . . . . .	62
<b>Chapter 2.4 Class 4 – Flammable solids; substances liable to spontaneous combustion; substances which, in contact with water, emit flammable gases</b>	
2.4.0 Introductory note . . . . .	63
2.4.1 Definition and general provisions. . . . .	63
2.4.2 Class 4.1 – Flammable solids, self-reactive substances and solid desensitized explosives. . . . .	63
2.4.3 Class 4.2 – Substances liable to spontaneous combustion . . . . .	70
2.4.4 Class 4.3 – Substances which, in contact with water, emit flammable gases . . . . .	71
2.4.5 Classification of organometallic substances. . . . .	71
<b>Chapter 2.5 Class 5 – Oxidizing substances and organic peroxides</b>	
2.5.0 Introductory note . . . . .	73
2.5.1 Definitions and general provisions. . . . .	73
2.5.2 Class 5.1 – Oxidizing substances . . . . .	73
2.5.3 Class 5.2 – Organic peroxides. . . . .	75
<b>Chapter 2.6 Class 6 – Toxic and infectious substances</b>	
2.6.0 Introductory notes . . . . .	88
2.6.1 Definitions. . . . .	88
2.6.2 Class 6.1 – Toxic substances. . . . .	88
2.6.3 Class 6.2 – Infectious substances . . . . .	92
<b>Chapter 2.7 Class 7 – Radioactive material</b>	
2.7.1 Definitions. . . . .	97
2.7.2 Classification . . . . .	98
<b>Chapter 2.8 Class 8 – Corrosive substances</b>	
2.8.1 Definition and properties . . . . .	117
2.8.2 Assignment of packing groups . . . . .	117

	<i>Page</i>
<b>Chapter 2.9 Miscellaneous dangerous substances and articles (Class 9) and environmentally hazardous substances</b>	
2.9.1 Definitions.....	119
2.9.2 Assignment to class 9 .....	119
2.9.3 Environmentally hazardous substances (aquatic environment) .....	121
2.9.4 Lithium batteries.....	130
<b>Chapter 2.10 Marine pollutants</b>	
2.10.1 Definition.....	132
2.10.2 General provisions .....	132
2.10.3 Classification .....	132
 <b>PART 3 – DANGEROUS GOODS LIST, SPECIAL PROVISIONS AND EXCEPTIONS</b>	
<b>Chapter 3.1 General</b>	
3.1.1 Scope and general provisions .....	135
3.1.2 Proper Shipping Names.....	136
3.1.3 Mixtures or solutions .....	137
3.1.4 Segregation groups .....	138
<b>Chapter 3.2 Dangerous Goods List</b>	
3.2.1 Structure of the Dangerous Goods List.....	152
3.2.2 Abbreviations and symbols .....	154
<b>Chapter 3.3 Special provisions applicable to certain substances, materials or articles</b>	
<b>Chapter 3.4 Dangerous goods packed in limited quantities</b>	
3.4.1 General .....	175
3.4.2 Packing.....	175
3.4.3 Stowage .....	175
3.4.4 Segregation .....	175
3.4.5 Marking and placarding .....	176
3.4.6 Documentation.....	177
<b>Chapter 3.5 Dangerous goods packed in excepted quantities</b>	
3.5.1 Excepted quantities .....	178
3.5.2 Packagings.....	179
3.5.3 Tests for packages .....	179
3.5.4 Marking of packages .....	179
3.5.5 Maximum number of packages in any cargo transport unit .....	180
3.5.6 Documentation.....	180
3.5.7 Stowage .....	180
3.5.8 Segregation .....	180
<b>Appendices</b>	
Appendix A – List of generic and N.O.S. Proper Shipping Names .....	183
Appendix B – Glossary of terms .....	197

	Page
<b>PART 4 – PACKING AND TANK PROVISIONS</b>	
<b>Chapter 4.1 Use of packagings, including intermediate bulk containers (IBCs) and large packagings</b>	
4.1.0 Definitions . . . . .	209
4.1.1 General provisions for the packing of dangerous goods in packagings, including IBCs and large packagings . . . . .	209
4.1.2 Additional general provisions for the use of IBCs . . . . .	213
4.1.3 General provisions concerning packing instructions . . . . .	213
4.1.4 List of packing instructions . . . . .	217
<i>Packing instructions concerning the use of packagings (except IBCs and large packagings)</i> . . . . .	217
<i>Packing instructions concerning the use of IBCs</i> . . . . .	272
<i>Packing instructions concerning the use of large packagings</i> . . . . .	276
4.1.5 Special packing provisions for goods of class 1 . . . . .	278
4.1.6 Special packing provisions for goods of class 2 . . . . .	279
4.1.7 Special packing provisions for organic peroxides (class 5.2) and self-reactive substances of class 4.1 . . . . .	281
4.1.8 Special packing provisions for infectious substances of category A (class 6.2, UN 2814 and UN 2900) . . . . .	282
4.1.9 Special packing provisions for class 7 . . . . .	283
<b>Chapter 4.2 Use of portable tanks and multiple-element gas containers (MEGCs)</b>	
4.2.0 Transitional provisions . . . . .	286
4.2.1 General provisions for the use of portable tanks for the transport of substances of class 1 and classes 3 to 9 . . . . .	287
4.2.2 General provisions for the use of portable tanks for the transport of non-refrigerated liquefied gases and chemicals under pressure . . . . .	290
4.2.3 General provisions for the use of portable tanks for the transport of refrigerated liquefied gases of class 2 . . . . .	291
4.2.4 General provisions for the use of multiple-element gas containers (MEGCs) . . . . .	292
4.2.5 Portable tank instructions and special provisions . . . . .	293
<i>Portable tank instructions</i> . . . . .	293
<i>Portable tank special provisions</i> . . . . .	302
4.2.6 Additional provisions for the use of road tank vehicles . . . . .	304
<b>Chapter 4.3 Use of bulk containers</b>	
4.3.1 General provisions . . . . .	305
4.3.2 Additional provisions applicable to bulk goods of classes 4.2, 4.3, 5.1, 6.2, 7 and 8 . . . . .	306
4.3.3 Additional provisions for the use of sheeted bulk containers (BK1) . . . . .	307
4.3.4 Additional provisions for the use of flexible bulk containers (BK3) . . . . .	307
<b>PART 5 – CONSIGNMENT PROCEDURES</b>	
<b>Chapter 5.1 General provisions</b>	
5.1.1 Application and general provisions . . . . .	311
5.1.2 Use of overpacks and unit loads . . . . .	311
5.1.3 Empty uncleaned packagings or units . . . . .	312
5.1.4 Mixed packing . . . . .	312
5.1.5 General provisions for class 7 . . . . .	312
5.1.6 Packages packed into a cargo transport unit . . . . .	315

	<i>Page</i>
<b>Chapter 5.2 Marking and labelling of packages including IBCs</b>	
5.2.1 Marking of packages including IBCs . . . . .	316
5.2.2 Labelling of packages including IBCs . . . . .	319
<b>Chapter 5.3 Placarding and marking of cargo transport units</b>	
5.3.1 Placarding . . . . .	326
5.3.2 Marking of cargo transport units . . . . .	327
<b>Chapter 5.4 Documentation</b>	
5.4.1 Dangerous goods transport information . . . . .	330
5.4.2 Container/vehicle packing certificate . . . . .	335
5.4.3 Documentation required aboard the ship . . . . .	336
5.4.4 Other required information and documentation . . . . .	336
5.4.5 Multimodal Dangerous Goods Form . . . . .	336
5.4.6 Retention of dangerous goods transport information . . . . .	340
<b>Chapter 5.5 Special provisions</b>	
5.5.1 [Reserved] . . . . .	341
5.5.2 Special provisions applicable to fumigated cargo transport units (UN 3359)	341
5.5.3 Special provisions applicable to packages and cargo transport units containing substances presenting a risk of asphyxiation when used for cooling or conditioning purposes (such as dry ice (UN 1845) or nitrogen, refrigerated liquid (UN 1977) or argon, refrigerated liquid (UN 1951)) . . . . .	342
 <b>PART 6 – CONSTRUCTION AND TESTING OF PACKAGINGS, INTERMEDIATE BULK CONTAINERS (IBCs), LARGE PACKAGINGS, PORTABLE TANKS, MULTIPLE-ELEMENT GAS CONTAINERS (MEGCs) AND ROAD TANK VEHICLES</b>	
<b>Chapter 6.1 Provisions for the construction and testing of packagings (other than for class 6.2 substances)</b>	
6.1.1 Applicability and general provisions . . . . .	347
6.1.2 Code for designating types of packagings . . . . .	348
6.1.3 Marking . . . . .	350
6.1.4 Provisions for packagings . . . . .	352
6.1.5 Test provisions for packagings . . . . .	360
<b>Chapter 6.2 Provisions for the construction and testing of pressure receptacles, aerosol dispensers, small receptacles containing gas (gas cartridges) and fuel cell cartridges containing liquefied flammable gas</b>	
6.2.1 General provisions . . . . .	366
6.2.2 Provisions for UN pressure receptacles . . . . .	370
6.2.3 Provisions for non-UN pressure receptacles . . . . .	381
6.2.4 Provisions for aerosol dispensers, small receptacles containing gas (gas cartridges) and fuel cell cartridges containing liquefied flammable gas . . . . .	382
<b>Chapter 6.3 Provisions for the construction and testing of packagings for class 6.2 infectious substances of category A</b>	
6.3.1 General . . . . .	384
6.3.2 Provisions for packagings . . . . .	384
6.3.3 Code for designating types of packagings . . . . .	384
6.3.4 Marking . . . . .	384
6.3.5 Test provisions for packagings . . . . .	385

	<i>Page</i>
<b>Chapter 6.4 Provisions for the construction, testing and approval of packages and material of class 7</b>	
6.4.1 [Reserved] . . . . .	389
6.4.2 General provisions . . . . .	389
6.4.3 Additional provisions for packages transported by air . . . . .	390
6.4.4 Provisions for excepted packages . . . . .	390
6.4.5 Provisions for industrial packages . . . . .	390
6.4.6 Provisions for packages containing uranium hexafluoride . . . . .	391
6.4.7 Provisions for Type A packages . . . . .	391
6.4.8 Provisions for Type B(U) packages . . . . .	392
6.4.9 Provisions for Type B(M) packages . . . . .	394
6.4.10 Provisions for Type C packages . . . . .	394
6.4.11 Provisions for packages containing fissile material . . . . .	394
6.4.12 Test procedures and demonstration of compliance . . . . .	396
6.4.13 Testing the integrity of the containment system and shielding and evaluating criticality safety . . . . .	397
6.4.14 Target for drop tests . . . . .	397
6.4.15 Test for demonstrating ability to withstand normal conditions of transport . . . . .	397
6.4.16 Additional tests for Type A packages designed for liquids and gases . . . . .	398
6.4.17 Tests for demonstrating ability to withstand accident conditions of transport . . . . .	398
6.4.18 Enhanced water immersion test for Type B(U) and Type B(M) packages containing more than $10^3A_2$ and Type C packages . . . . .	399
6.4.19 Water leakage test for packages containing fissile material . . . . .	399
6.4.20 Tests for Type C packages . . . . .	399
6.4.21 Tests for packagings designed to contain uranium hexafluoride . . . . .	399
6.4.22 Approvals of package designs and materials . . . . .	400
6.4.23 Applications for approval and approvals for radioactive material transport . . . . .	400
6.4.24 Transitional measures for class 7 . . . . .	405
<b>Chapter 6.5 Provisions for the construction and testing of intermediate bulk containers (IBCs)</b>	
6.5.1 General requirements . . . . .	407
6.5.2 Marking . . . . .	409
6.5.3 Construction requirements . . . . .	412
6.5.4 Testing, certification and inspection . . . . .	412
6.5.5 Specific provisions for IBCs . . . . .	414
6.5.6 Test provisions for IBCs . . . . .	419
<b>Chapter 6.6 Provisions for the construction and testing of large packagings</b>	
6.6.1 General . . . . .	426
6.6.2 Code for designating types of large packagings . . . . .	426
6.6.3 Marking . . . . .	426
6.6.4 Specific provisions for large packagings . . . . .	428
6.6.5 Test provisions for large packagings . . . . .	430
<b>Chapter 6.7 Provisions for the design, construction, inspection and testing of portable tanks and multiple-element gas containers (MEGCs)</b>	
6.7.1 Application and general provisions . . . . .	434
6.7.2 Provisions for the design, construction, inspection and testing of portable tanks intended for the transport of substances of class 1 and classes 3 to 9 . . . . .	434



	Page
6.7.3 Provisions for the design, construction, inspection and testing of portable tanks intended for the transport of non-refrigerated liquefied gases of class 2 . . .	448
6.7.4 Provisions for the design, construction, inspection and testing of portable tanks intended for the transport of refrigerated liquefied gases of class 2 . . . . .	459
6.7.5 Provisions for the design, construction, inspection and testing of multiple-element gas containers (MEGCs) intended for the transport of non-refrigerated gases . . . . .	469
<b>Chapter 6.8 Provisions for road tank vehicles</b>	
6.8.1 General . . . . .	476
6.8.2 Road tank vehicles for long international voyages for substances of classes 3 to 9 . . . . .	476
6.8.3 Road tank vehicles for short international voyages. . . . .	476
<b>Chapter 6.9 Provisions for the design, construction, inspection and testing of bulk containers</b>	
6.9.1 Definitions. . . . .	480
6.9.2 Application and general provisions . . . . .	480
6.9.3 Provisions for the design, construction, inspection and testing of freight containers used as BK1 or BK2 bulk containers . . . . .	480
6.9.4 Provisions for the design, construction and approval of BK1 or BK2 bulk containers other than freight containers . . . . .	481
6.9.5 Requirements for the design, construction, inspection and testing of flexible bulk containers BK3 . . . . .	482
 <b>PART 7 – PROVISIONS CONCERNING TRANSPORT OPERATIONS</b>	
<b>Chapter 7.1 General stowage provisions</b>	
7.1.1 Introduction . . . . .	493
7.1.2 Definitions. . . . .	493
7.1.3 Stowage categories . . . . .	494
7.1.4 Special stowage provisions . . . . .	495
<b>Chapter 7.2 General segregation provisions</b>	
7.2.1 Introduction . . . . .	500
7.2.2 Definitions. . . . .	500
7.2.3 Segregation provisions . . . . .	500
7.2.4 Segregation table. . . . .	501
7.2.5 Segregation groups . . . . .	502
7.2.6 Special segregation provisions and exemptions. . . . .	502
7.2.7 Segregation of goods of class 1 . . . . .	503
<i>Annex: Segregation flow chart. . . . .</i>	<i>505</i>
<b>Chapter 7.3 Consigning operations concerning the packing and use of cargo transport units (CTUs) and related provisions</b>	
7.3.1 Introduction . . . . .	507
7.3.2 General provisions for cargo transport units. . . . .	507
7.3.3 Packing of cargo transport units . . . . .	507
7.3.4 Segregation provisions within cargo transport units. . . . .	508
7.3.5 Tracking and monitoring equipment . . . . .	509
7.3.6 Opening and unloading cargo transport units. . . . .	509
7.3.7 Cargo transport units under temperature control . . . . .	509
7.3.8 Loading of cargo transport units on board ships . . . . .	512

---

	<i>Page</i>
<b>Chapter 7.4 Stowage and segregation on containerships</b>	
7.4.1 Introduction . . . . .	513
7.4.2 Stowage requirements . . . . .	513
7.4.3 Segregation requirements . . . . .	514
<b>Chapter 7.5 Stowage and segregation on ro-ro ships</b>	
7.5.1 Introduction . . . . .	517
7.5.2 Stowage provisions . . . . .	517
7.5.3 Segregation provisions . . . . .	518
<b>Chapter 7.6 Stowage and segregation on general cargo ships</b>	
7.6.1 Introduction . . . . .	519
7.6.2 Stowage and handling provisions . . . . .	519
7.6.3 Segregation provisions . . . . .	523
<b>Chapter 7.7 Shipborne barges on barge-carrying ships</b>	
7.7.1 Introduction . . . . .	527
7.7.2 Definitions . . . . .	527
7.7.3 Barge loading . . . . .	527
7.7.4 Stowage of shipborne barges . . . . .	528
7.7.5 Segregation between barges on board barge carrying ships . . . . .	528
<b>Chapter 7.8 Special requirements in the event of an incident and fire precautions involving dangerous goods</b>	
7.8.1 General . . . . .	529
7.8.2 General provisions in the event of incidents . . . . .	529
7.8.3 Special provisions for incidents involving infectious substances . . . . .	529
7.8.4 Special provisions for incidents involving radioactive material . . . . .	530
7.8.5 General fire precautions . . . . .	530
7.8.6 Special fire precautions for class 1 . . . . .	531
7.8.7 Special fire precautions for class 2 . . . . .	531
7.8.8 Special fire precautions for class 3 . . . . .	531
7.8.9 Special fire precautions and fire fighting for class 7 . . . . .	531
<b>Chapter 7.9 Exemptions, approvals and certificates</b>	
7.9.1 Exemptions . . . . .	532
7.9.2 Approvals (including permits, authorizations or agreements) and certificates	532
7.9.3 Contact information for the main designated national competent authorities	532

INDEX

## Foreword

The International Convention for the Safety of Life at Sea, 1974 (SOLAS), as amended, deals with various aspects of maritime safety and contains in chapter VII the mandatory provisions governing the carriage of dangerous goods in packaged form or in solid form in bulk. The carriage of dangerous goods is prohibited except in accordance with the relevant provisions of chapter VII, which are amplified by the International Maritime Dangerous Goods (IMDG) Code.

Regulation II-2/19 of the SOLAS Convention, as amended, specifies the special requirements for a ship intended to carry dangerous goods, the keel of which was laid or which was at a similar stage of construction on or after 1 July 2002.

The International Convention for the Prevention of Pollution from Ships, 1973, as modified by the Protocol of 1978 relating thereto (MARPOL), deals with various aspects of prevention of marine pollution, and contains in its Annex III the mandatory provisions for the prevention of pollution by harmful substances carried by sea in packaged form. Regulation 1(2) prohibits the carriage of harmful substances in ships except in accordance with the provisions of Annex III, which are also amplified by the IMDG Code.

In accordance with the Provisions concerning Reports on Incidents Involving Harmful Substances (Protocol I to MARPOL), incidents involving losses of such substances from ships must be reported by the master or other person having charge of the ship concerned.

The IMDG Code that was adopted by resolution A.716(17) and amended by Amendments 27 to 30 was recommended to Governments for adoption or for use as the basis for national regulations in pursuance of their obligations under regulation VII/1.4 of the 1974 SOLAS Convention, as amended, and regulation 1(3) of Annex III of MARPOL. The IMDG Code, as amended, attained mandatory status from 1 January 2004 under the umbrella of SOLAS, 1974; however, some parts of the Code continue to be recommendatory. Observance of the Code harmonizes the practices and procedures followed in the carriage of dangerous goods by sea and ensures compliance with the mandatory provisions of the SOLAS Convention and of Annex III of MARPOL.

The Code, which sets out in detail the requirements applicable to each individual substance, material or article, has undergone many changes, in both layout and content, in order to keep pace with the expansion and progress of industry. IMO's Maritime Safety Committee (MSC) is authorized by the Organization's Assembly to adopt amendments to the Code, thus enabling IMO to respond promptly to developments in transport.

The MSC at its ninetieth session agreed that, in order to facilitate the multimodal transport of dangerous goods, the provisions of the IMDG Code, 2012, may be applied from 1 January 2013 on a voluntary basis, pending their official entry into force on 1 January 2014 without any transitional period. This is described in resolution MSC.328(90) and the Preamble to this Code. It needs to be emphasized that, in the context of the language of the Code, the words "shall", "should" and "may", when used in the Code, mean that the relevant provisions are "mandatory", "recommendatory" and "optional", respectively.

### *Reference marks*

The following symbols placed against an item indicate changes from the previous edition, in accordance with Amendment 36-12 to the IMDG Code:

- Insertion of an item
- ⊗ Deletion of an item
- △ Change to an item

For detailed information on changes, please visit <http://gisis.imo.org> and navigate to the IMDG Code module (free, instant registration required). Please inform IMO of any apparent discrepancies or errors in the texts of the different versions of the IMDG Code (IMO documents, the printed publication and CD/download and Internet versions of the Code) by means of the same link.

*Foreword*

---

The IMDG Code is also available as a fully searchable database on CD or as a download (including the items within its Supplement). Intranet and Internet (subscription) versions are also available. For more information, please visit the IMO Publishing Service website at [www.imo.org](http://www.imo.org) to see a live demonstration of the CD/download versions and obtain details of how online subscription to the IMDG Code works. If and when required, the IMO website will also include any files that show errata or corrigenda to this edition of the IMDG Code.

## Preamble

- 1 Carriage of dangerous goods by sea is regulated in order to reasonably prevent injury to persons or damage to ships and their cargoes. Carriage of marine pollutants is primarily regulated to prevent harm to the marine environment. The objective of the IMDG Code is to enhance the safe carriage of dangerous goods while facilitating the free unrestricted movement of such goods and prevent pollution to the environment.
- 2 Over the years, many maritime countries have taken measures to regulate the transport of dangerous goods by sea. The various regulations, codes and practices, however, differed in their framework and, in particular, in the identification and labelling of such goods. Both the terminology used and the provisions for packaging and stowage varied from country to country and created difficulties for all directly or indirectly concerned with the transport of dangerous goods by sea.
- 3 The need for international regulation of the transport of dangerous goods by sea was recognized by the 1929 International Conference on Safety of Life at Sea (SOLAS), which recommended that rules on the subject have international effect. The classification of dangerous goods and certain general provisions concerning their transport in ships were adopted by the 1948 SOLAS Conference. This Conference also recommended further study with the object of developing international regulations.
- 4 Meanwhile, the Economic and Social Council of the United Nations had appointed an ad hoc Committee of Experts on the Transport of Dangerous Goods (UN Committee of Experts), which had been actively considering the international aspect of the transport of dangerous goods by all modes of transport. This committee completed a report in 1956 dealing with classification, listing and labelling of dangerous goods and with the transport documents required for such goods. This report, with subsequent modifications, offered a general framework to which existing regulations could be harmonized and within which they could be further developed. The primary goal being world-wide uniformity for regulations concerning the transport of dangerous goods by sea as well as other modes of transport.
- 5 As a further step towards meeting the need for international rules governing the transport of dangerous goods in ships, the 1960 SOLAS Conference, in addition to laying down a general framework of provisions in chapter VII of the SOLAS Convention, invited IMO (Recommendation 56) to undertake a study with a view to establishing a unified international code for the transport of dangerous goods by sea. This study would be pursued in co-operation with the UN Committee of Experts and should take account of existing maritime practices and procedures. The Conference further recommended that the unified code be prepared by IMO and that it be adopted by the Governments that were Parties to the 1960 Convention.
- 6 To implement Recommendation 56, IMO's Maritime Safety Committee (MSC) appointed a working group drawn from those countries having considerable experience in the transport of dangerous goods by sea. Preliminary drafts for each class of substances, materials and articles were subsequently brought under close scrutiny by the working group to take into account throughout the practices and procedures of a number of maritime countries in order to make the Code as widely acceptable as possible. This new International Maritime Dangerous Goods (IMDG) Code was approved by the MSC and recommended to Governments by the Assembly of IMO in 1965.
- 7 During another SOLAS Conference held in 1974, chapter VII of the Convention remained essentially unchanged. Since that date, several amendments to chapter VII adopted by the MSC have entered into force. Although invoked by a footnote reference in regulation 1 of chapter VII, the IMDG Code itself had only recommendatory status until 31 December 2003.
- 8 At the International Conference on Marine Pollution, 1973, the need was recognized to preserve the marine environment. It was further recognized that negligent or accidental release of marine pollutants transported by sea in packaged form should be minimized. Consequently, provisions were established and adopted by the Conference, and are contained in Annex III of the International Convention for the Prevention of Pollution from Ships, 1973, as modified by the Protocol of 1978 relating thereto (MARPOL 73/78). The Marine Environment Protection Committee (MEPC) decided in 1985 that Annex III should be implemented through the IMDG Code. This decision was also endorsed by the MSC in 1985. Since that date, several amendments to Annex III to MARPOL 73/78 have entered into force.
- 9 The UN Committee of Experts has continued to meet until the present day and its published "Recommendations on the Transport of Dangerous Goods" are updated biennially. In 1996, the MSC agreed that the IMDG Code should be reformatted consistent with the format of the UN Recommendations on the Transport of

*Preamble*

---

Dangerous Goods. The consistency in format of the UN Recommendations, the IMDG Code and other dangerous goods transport regulations is intended to enhance user-friendliness, compliance with the regulations, and the safe transport of dangerous goods.

- 10 In 2002, the MSC adopted amendments to SOLAS chapter VII to make the IMDG Code mandatory, which came into force on 1 January 2004. Since then, further amendments were adopted to facilitate user friendliness and promote uniform implementation of the Code. In addition, at its 90th session in May 2012, the MSC adopted amendment 36-12 to the mandatory IMDG Code, which is a complete consolidated and updated version of its text and which will enter into force on 1 January 2014 without any transitional period. However, in accordance with resolution MSC ....., Governments were encouraged to apply this Amendment in whole or on part on a voluntary basis from 1 January 2013
- 11 In order to keep the Code up to date from the maritime transport operational aspect, the MSC will continue to take into account technological developments, as well as changes to chemical classifications and the related consignment provisions that primarily concern the shipper/consignor. The two-year periodicity of amendments to the UN Recommendations on Transport of Dangerous Goods will also provide the source of most future updating of the IMDG Code.
- 12 The MSC will also have regard to future implications for the carriage of dangerous goods by sea, in particular, arising from any acceptance by the UN Conference on Environmental Development (UNCED) of common criteria for the classification of chemicals on the basis of a Global Harmonization System (GHS).
- 13 Attention is drawn to IMO document FAL.6/Circ.14, a list of existing publications relevant to areas and topics relating to ship/port interface matters.
- 14 Advice on emergency procedures and for initial management of chemical poisoning and diagnosis that may be used in conjunction with the IMDG Code is published separately in "The EmS Guide: Emergency Response Procedures for Ships Carrying Dangerous Goods" (MSC.1/Circ.1025 as amended by MSC.1/Circ.1025/Add.1, MSC.1/Circ.1262, MSC.1/Circ.1360 and MSC.1/Circ.....) and in the "Medical First Aid Guide for Use in Accidents Involving Dangerous Goods" (see MSC/Circ.857 and DSC 3/15/Add.2), respectively.
- 15 In addition, referring to Part D of chapter VII of the SOLAS Convention, a ship transporting INF cargo, as defined in regulation VII/14.2, shall comply with the requirements of the International Code for the Safe Carriage of Packaged Irradiated Nuclear Fuel, Plutonium and High-Level Radioactive Wastes on board Ships (INF Code).



# PART 1

GENERAL PROVISIONS,  
DEFINITIONS AND TRAINING





# Chapter 1.1

## *General provisions*

### **1.1.0 Introductory note**

It should be noted that other international and national modal regulations exist and that those regulations may recognize all or part of the provisions of this Code. In addition, port authorities and other bodies and organizations should recognize the Code and may use it as a basis for their storage and handling by-laws within loading and discharge areas.

### **1.1.1 Application and implementation of the Code**

**1.1.1.1** The provisions contained in this Code are applicable to all ships to which the International Convention for the Safety of Life at Sea, 1974 (SOLAS 74), as amended, applies and which are carrying dangerous goods as defined in regulation 1 of part A of chapter VII of that Convention.

**1.1.1.2** The provisions of regulation II-2/19 of that Convention apply to passenger ships and to cargo ships constructed on or after 1 July 2002.

For:

- .1 a passenger ship constructed on or after 1 September 1984 but before 1 July 2002; or
- .2 a cargo ship of 500 gross tons or over constructed on or after 1 September 1984 but before 1 July 2002; or
- .3 a cargo ship of less than 500 gross tons constructed on or after 1 February 1992 but before 1 July 2002,

the requirements of regulation II-2/54 of SOLAS, 1974, as amended by resolutions MSC.1(XLV), MSC.6(48), MSC.13(57), MSC.22(59), MSC.24(60), MSC.27(61), MSC.31(63) and MSC.57(67), apply (see II-2/1.2).

For cargo ships of less than 500 gross tons constructed on or after 1 September 1984 and before 1 February 1992, it is recommended that Contracting Governments extend such application to these cargo ships as far as possible.

**1.1.1.3** All ships, irrespective of type and size, carrying substances, material or articles identified in this Code as marine pollutants are subject to the provisions of this Code.

**1.1.1.4** In certain parts of this Code, a particular action is prescribed, but the responsibility for carrying out the action is not specifically assigned to any particular person. Such responsibility may vary according to the laws and customs of different countries and the international conventions into which these countries have entered. For the purpose of this Code, it is not necessary to make this assignment, but only to identify the action itself. It remains the prerogative of each Government to assign this responsibility.

**1.1.1.5** Although this Code is legally treated as a mandatory instrument under chapter VII of SOLAS 74, as amended, the following provisions of the Code remain recommendatory:

- .1 paragraph 1.1.1.8 (Notification of infringements);
- .2 paragraphs 1.3.1.4 to 1.3.1.7 (Training);
- .3 chapter 1.4 (Security provisions) except 1.4.1.1, which is mandatory;
- .4 section 2.1.0 of chapter 2.1 (Class 1 – Explosives, Introductory notes);
- .5 section 2.3.3 of chapter 2.3 (Determination of flashpoint);
- .6 columns (15) and (17) of the Dangerous Goods List in chapter 3.2;
- .7 The segregation flow chart and example in the annex to chapter 7.2
- .8 section 5.4.5 of chapter 5.4 (Multimodal Dangerous Goods Form), insofar as the layout of the form is concerned;

Part 1 – General provisions, definitions and training

---

- .9 chapter 7.8 (Special provisions in the event of an incident and fire precautions involving dangerous goods);
- .10 section 7.9.3 (Contact information for the main designated national competent authorities); and
- .11 appendix B.

1.1.1.6 Application of standards

Where the application of a standard is required and there is any conflict between the standard and the provisions of this Code, the provisions of this Code take precedence.

1.1.1.7 Transport of dangerous goods used as a coolant or conditioner

Dangerous goods, that are only asphyxiant (which dilute or replace the oxygen normally in the atmosphere), when used in cargo transport units for cooling or conditioning purposes are only subject to the provisions of section 5.5.3.

**Note:** When carried on board as ship's stores or equipment, these coolants and conditioners are not subject to the provisions of this Code

1.1.1.8 Notification of infringements

When a competent authority has reasons to believe that the safety of the transport of dangerous goods is compromised as a result of serious or repeated infringements of this Code by an enterprise which has its headquarters on the territory of another competent authority, it should if necessary notify that competent authority of such infringements.

1.1.2 Conventions

1.1.2.1 International Convention for the Safety of Life at Sea, 1974

Part A of chapter VII of the International Convention for the Safety of Life at Sea, 1974 (SOLAS 1974), as amended, deals with the carriage of dangerous goods in packaged form, and is reproduced in full:

**CHAPTER VII**  
**Carriage of Dangerous Goods**

**Part A**

*Carriage of Dangerous Goods in Packaged Form*

**Regulation 1**

*Definitions*

For the purpose of this chapter, unless expressly provided otherwise:

- 1** *IMDG Code* means the International Maritime Dangerous Goods (IMDG) Code adopted by the Maritime Safety Committee of the Organization by resolution MSC.122(75), as may be amended by the Organization, provided that such amendments are adopted, brought into force and take effect in accordance with the provisions of article VIII of the present Convention concerning the amendment procedures applicable to the annex other than chapter I.
- 2** *Dangerous goods* mean the substances, materials and articles covered by the IMDG Code.
- 3** *Packaged form* means the form of containment specified in the IMDG Code.

**Regulation 2**

*Application\**

- 1** Unless expressly provided otherwise, this part applies to the carriage of dangerous goods in packaged form in all ships to which the present regulations apply and in cargo ships of less than 500 gross tonnage.

---

\* Refer to:

.1 part D which contains special requirements for the carriage of INF cargo; and

- 2 The provisions of this part do not apply to ships' stores and equipment.
- 3 The carriage of dangerous goods in packaged form is prohibited except in accordance with the provisions of this chapter.
- 4 To supplement the provisions of this part, each Contracting Government shall issue, or cause to be issued, detailed instructions on emergency response and medical first aid relevant to incidents involving dangerous goods in packaged form, taking into account the guidelines developed by the Organization.\*

### Regulation 3

#### *Requirements for the carriage of dangerous goods*

The carriage of dangerous goods in packaged form shall comply with the relevant provisions of the IMDG Code.

### Regulation 4<sup>†</sup>

#### *Documents*

- 1 Transport information relating to the carriage of dangerous goods in packaged form and the container/vehicle packing certificate shall be in accordance with the relevant provisions of the IMDG Code and shall be made available to the person or organization designated by the port State authority.
- 2 Each ship carrying dangerous goods in packaged form shall have a special list, manifest or stowage plan setting forth, in accordance with the relevant provisions of the IMDG Code, the dangerous goods on board and the location thereof. A copy of one of these documents shall be made available before departure to the person or organization designated by the port State authority.

### Regulation 5

#### *Cargo Securing Manual*

Cargo, cargo units<sup>‡</sup> and cargo transport units, shall be loaded, stowed and secured throughout the voyage in accordance with the Cargo Securing Manual approved by the Administration. The Cargo Securing Manual shall be drawn up to a standard at least equivalent to the guidelines developed by the Organization.<sup>§</sup>

### Regulation 6

#### *Reporting of incidents involving dangerous goods*

- 1 When an incident takes place involving the loss or likely loss overboard of dangerous goods in packaged form into the sea, the master, or other person having charge of the ship, shall report the particulars of such an incident without delay and to the fullest extent possible to the nearest coastal State. The report shall be drawn up based on general principles and guidelines developed by the Organization.<sup>¶</sup>
- 2 In the event of the ship referred to in paragraph 1 being abandoned, or in the event of a report from such a ship being incomplete or unobtainable, the company, as defined in regulation IX/1.2, shall, to the fullest extent possible, assume the obligations placed upon the master by this regulation.

#### 1.1.2.2 International Convention for the Prevention of Pollution from Ships, MARPOL 1973/78

- 1.1.2.2.1 Annex III of the International Convention for the Prevention of Pollution from Ships, 1973, as modified by the Protocol of 1978 relating thereto (MARPOL 73/78), deals with the prevention of pollution by harmful

.2 regulation II-2/19 which contains special requirements for ships carrying dangerous goods.

\* Refer to:

- .1 the *Emergency Response Procedures for Ships Carrying Dangerous Goods* (EmS Guide) (MSC.1/Circ.1025, as amended); and
- .2 the *Medical First Aid Guide for Use in Accidents Involving Dangerous Goods* (MFAG) (MSC/Circ.857), published by the Organization.

<sup>†</sup> The revised text of Regulation 4 was adopted by [Resolution MSC.....(90)], which will enter into force on 1 January 2014, which is the mandatory entry into force date of amendment 36-12 of the IMDG code.

<sup>‡</sup> As defined in the Code of Safe Practice for Cargo Stowage and Securing (CSS Code), adopted by the Organization by resolution A.714(17), as amended.

<sup>§</sup> Refer to the Revised Guidelines for the preparation of the Cargo Securing Manual (MSC.1/Circ.1353).

<sup>¶</sup> Refer to the General principles for ship reporting systems and ship reporting requirements, including guidelines for reporting incidents involving dangerous goods, harmful substances and/or marine pollutants, adopted by the Organization by resolution A.851(20), as amended.

substances carried by sea in packaged form and is reproduced in full, as revised by the Marine Environment Protection Committee.\*

**Annex III**  
**Regulations for the Prevention of Pollution by Harmful Substances**  
**Carried by Sea in Packaged Form**

**Regulation 1**

*Application*

- 1** Unless expressly provided otherwise, the regulations of this Annex apply to all ships carrying harmful substances in packaged form.
  - .1 For the purpose of this Annex, "harmful substances" are those substances which are identified as marine pollutants in the International Maritime Dangerous Goods Code (IMDG Code)<sup>†</sup> or which meet the criteria in the Appendix of this Annex.
  - .2 For the purposes of this Annex, "packaged form" is defined as the forms of containment specified for harmful substances in the IMDG Code.
- 2** The carriage of harmful substances is prohibited, except in accordance with the provisions of this Annex.
- 3** To supplement the provisions of this Annex, the Government of each Party to the Convention shall issue, or cause to be issued, detailed requirements on packing, marking, labelling, documentation, stowage, quantity limitations and exceptions for preventing or minimizing pollution of the marine environment by harmful substances.\*
- 4** For the purposes of this Annex, empty packagings which have been used previously for the carriage of harmful substances shall themselves be treated as harmful substances unless adequate precautions have been taken to ensure that they contain no residue that is harmful to the marine environment.
- 5** The requirements of this Annex do not apply to ship's stores and equipment.

**Regulation 2**

*Packing*

Packages shall be adequate to minimize the hazard to the marine environment, having regard to their specific contents.

**Regulation 3**

*Marking and labelling*

- 1** Packages containing a harmful substance shall be durably marked or labelled to indicate that the substance is a harmful substance in accordance with the relevant provisions of the IMDG Code.
- 2** The method of affixing marks or labels on packages containing a harmful substance shall be in accordance with the relevant provisions of the IMDG Code.

**Regulation 4<sup>‡</sup>**

*Documentation*

- 1** Transport information relating to the carriage of harmful substances shall be in accordance with the relevant provisions of the IMDG Code and shall be made available to the person or organization designated by the port State authority.
- 2** Each ship carrying harmful substances shall have a special list, manifest or stowage plan setting forth, in accordance with the relevant provisions of the IMDG Code, the harmful substances on board and the location thereof. A copy of one of these documents shall be made available before departure to the person or organization designated by the port State authority.

---

\* The revised text of Annex III was adopted by resolution MEPC.193(61), which will enter into force on 1 January 2014, which is the mandatory entry into force date of amendment 36-12 to the IMDG Code.

<sup>†</sup> Refer to the IMDG Code adopted by the Organization by resolution MSC.122(75), as amended by the Maritime Safety Committee

<sup>‡</sup> Reference to "documents" in this regulation does not preclude the use of electronic data processing (EDP) and electronic data interchange (EDI) transmission techniques as an aid to paper documentation.

## Regulation 5

### *Stowage*

Harmful substances shall be properly stowed and secured so as to minimize the hazards to the marine environment without impairing the safety of the ship and persons on board.

## Regulation 6

### *Quantity limitations*

Certain harmful substances may, for sound scientific and technical reasons, need to be prohibited for carriage or be limited as to the quantity which may be carried aboard any one ship. In limiting the quantity, due consideration shall be given to size, construction and equipment of the ship, as well as the packaging and the inherent nature of the substances.

## Regulation 7

### *Exceptions*

- 1 Jettisoning of harmful substances carried in packaged form shall be prohibited, except where necessary for the purpose of securing the safety of the ship or saving life at sea.
- 2 Subject to the provisions of the present Convention, appropriate measures based on the physical, chemical and biological properties of harmful substances shall be taken to regulate the washing of leakages overboard, provided that compliance with such measures would not impair the safety of the ship and persons on board.

## Regulation 8

### *Port State control on operational requirements\**

- 1 A ship when in a port or an offshore terminal of another Party is subject to inspection by officers duly authorized by such Party concerning operational requirements under this Annex.
- 2 Where there are clear grounds for believing that the master or crew are not familiar with essential shipboard procedures relating to the prevention of pollution by harmful substances, the Party shall take such steps, including carrying out detailed inspection and, if required, will ensure that the ship shall not sail until the situation has been brought to order in accordance with the requirements of this Annex.
- 3 Procedures relating to the port State control prescribed in article 5 of the present Convention shall apply to this regulation.
- 4 Nothing in this regulation shall be construed to limit the rights and obligations of a Party carrying out control over operational requirements specifically provided for in the present Convention.

## Appendix to Annex III

### *Criteria for the identification of harmful substances in packaged form*

For the purposes of this Annex, substances identified by any one of the following criteria are harmful substances:†

- (a) Acute (short-term) aquatic hazard

Category: Acute 1	
96 hr LC <sub>50</sub> (for fish)	≤ 1 mg/ℓ and/or
48 hr EC <sub>50</sub> (for crustacea)	≤ 1 mg/ℓ and/or
72 or 96 hr ErC <sub>50</sub> (for algae or other aquatic plants)	≤ 1 mg/ℓ

\* Refer to the Procedures for port State control adopted by the Organization by resolution A.787(19) and amended by resolution A.882(21).

† The criteria are based on those developed by the United Nations Globally Harmonized System of Classification and Labelling of Chemicals (GHS), as amended. For definitions of acronyms or terms used in this appendix, refer to the relevant paragraphs of the IMDG Code.

**Part 1 – General provisions, definitions and training**

- (b) Long-term aquatic hazard  
 (i) Non-rapidly degradable substances for which there are adequate chronic toxicity data available

Category: Chronic 1	
Chronic NOEC or EC <sub>x</sub> (for fish)	≤ 0.1 mg/ℓ and/or
Chronic NOEC or ECx (for crustacea)	≤ 0.1 mg/ℓ and/or
Chronic NOEC or ECx (for algae or other aquatic plants)	≤ 0.1 mg/ℓ

Category: Chronic 2	
Chronic NOEC or ECx (for fish)	≤ 1 mg/ℓ and/or
Chronic NOEC or ECx (for crustacea)	≤ 1 mg/ℓ and/or
Chronic NOEC or ECx (for algae or other aquatic plants)	≤ 1 mg/ℓ

- (ii) Rapidly degradable substances for which there are adequate chronic toxicity data available

Category Chronic 1:	
Chronic NOEC or ECx (for fish)	≤ 0.01 mg/ℓ and/or
Chronic NOEC or ECx (for crustacea)	≤ 0.01 mg/ℓ and/or
Chronic NOEC or ECx (for algae or other aquatic plants)	≤ 0.01 mg/ℓ

Category Chronic 2:	
Chronic NOEC or ECx (for fish)	≤ 0.1 mg/ℓ and/or
Chronic NOEC or ECx (for crustacea)	≤ 0.1 mg/ℓ and/or
Chronic NOEC or ECx (for algae or other aquatic plants)	≤ 0.1 mg/ℓ

- (iii) Substances for which adequate chronic toxicity data are not available

Category Chronic 1:	
96 hr LC50 (for fish)	≤ 1 mg/ℓ and/or
48 hr EC50 (for crustacea)	≤ 1 mg/ℓ and/or
72 or 96 hr ErC50 (for algae or other aquatic plants)	≤ 1 mg/ℓ
and the substance is not rapidly degradable and/or the experimentally determined BCF is ≥ 500 (or, if absent the log Kow ≥ 4).	

Category Chronic 2:	
96 hr LC50 (for fish)	>1 mg/ℓ but ≤ 10 mg/ℓ and/or
48 hr EC50 (for crustacea)	>1 mg/ℓ but ≤ 10 mg/ℓ and/or
72 or 96 hr ErC50 (for algae or other aquatic plants)	>1 mg/ℓ but ≤ 10 mg/ℓ
and the substance is not rapidly degradable and/or the experimentally determined BCF is ≥ 500 (or, if absent, the log Kow ≥ 4).	

Additional guidance on the classification process for substances and mixtures is included in the IMDG Code.

**1.1.3 Dangerous goods forbidden from transport**

**1.1.3.1** Unless provided otherwise by this Code, the following are forbidden from transport:

Any substance or article which, as presented for transport, is liable to explode, dangerously react, produce a flame or dangerous evolution of heat or dangerous emission of toxic, corrosive or flammable gases or vapours under normal conditions of transport.

In chapter 3.3, special provisions 349, 350, 351, 352, 353 and 900 list certain substances, which are forbidden for transport.

## Chapter 1.2

### *Definitions, units of measurement and abbreviations*

---

#### 1.2.1 Definitions

The following is a list of definitions of general applicability that are used throughout this Code. Additional definitions of a highly specific nature are presented in the relevant chapters.

For the purposes of this Code:

*Aerosols or aerosol dispensers* means non-refillable receptacles meeting the provisions of 6.2.4, made of metal, glass or plastics and containing a gas compressed, liquefied or dissolved under pressure, with or without a liquid, paste or powder, and fitted with a release device allowing the contents to be ejected as solid or liquid particles in suspension in a gas, as a foam, paste or powder or in a liquid state or in a gaseous state.

*Alternative arrangement* means an approval granted by the competent authority for a portable tank or MEGC that has been designed, constructed or tested to technical requirements or testing methods other than those specified in this Code (see, for instance, 6.7.5.11.1).

*Animal material* means animal carcasses, animal body parts, or animal foodstuffs.

*Approval*

*Multilateral approval*, for the transport of class 7 material, means approval by the relevant competent authority of the country of origin of the design or shipment, as applicable, and also, where the consignment is to be transported through or into any other country, approval by the competent authority of that country.

*Unilateral approval*, for the transport of class 7 material, means an approval of a design which is required to be given by the competent authority of the country of origin of the design only.

*Bags* means flexible packagings made of paper, plastic film, textiles, woven material, or other suitable materials.

*Barge-carrying ship* means a ship specially designed and equipped to transport shipborne barges.

*Barge feeder vessel* means a vessel specially designed and equipped to transport shipborne barges to or from a barge-carrying ship.

*Boxes* means packagings with complete rectangular or polygonal faces, made of metal, wood, plywood, reconstituted wood, fibreboard, plastics, or other suitable material. Small holes for purposes such as ease of the handling or opening of the box or to meet classification provisions are permitted as long as they do not compromise the integrity of the packaging during transport.

*Bulk containers* are containment systems (including any liner or coating) intended for the transport of solid substances which are in direct contact with the containment system. Packagings, intermediate bulk containers (IBCs), large packagings and portable tanks are not included.

Bulk containers:

- are of a permanent character and accordingly strong enough to be suitable for repeated use;
- are specially designed to facilitate the transport of goods by one or more means of transport without intermediate reloading;
- are fitted with devices permitting ready handling; and
- have a capacity of not less than 1 cubic metre.

Examples of bulk containers are freight containers, offshore bulk containers, skips, bulk bins, swap bodies, trough-shaped containers, roller containers, load compartments of vehicles or flexible bulk containers.

*Bundles of cylinders* are assemblies of cylinders that are fastened together and which are interconnected by a manifold and transported as a unit. The total water capacity shall not exceed 3000 litres except that bundles intended for the transport of gases of class 2.3 shall be limited to 1000 litres water capacity.



*Cargo transport unit* means a road transport tank or freight vehicle, a railway transport tank or freight wagon, a multimodal freight container or portable tank, or an MEGC.

*Carrier* means any person, organization or Government undertaking the transport of dangerous goods by any means of transport. The term includes both carriers for hire or reward (known as *common* or *contract carriers* in some countries) and carriers on own account (known as *private carriers* in some countries).

*Cellular ship* means a ship in which containers are loaded under deck into specially designed slots giving a permanent stowage of the container during sea transport. Containers loaded on deck in such a ship are specially stacked and secured on fittings.

*Closed cargo transport unit*, with the exception of class 1, means a cargo transport unit which totally encloses the contents by permanent structures with complete and rigid surfaces. Cargo transport units with fabric sides or tops are not considered closed cargo transport units; for definition of closed cargo transport unit for class 1, see 7.1.2.

*Closed ro-ro cargo space* means a ro-ro cargo space which is neither an open ro-ro cargo space nor a weather deck.

*Closure* means a device which closes an opening in a receptacle.

*Combination packagings* means a combination of packagings for transport purposes, consisting of one or more inner packagings secured in an outer packaging in accordance with 4.1.1.5.

*Competent authority* means any body or authority designated or otherwise recognized as such for any purpose in connection with this Code.

*Compliance assurance* means a systematic programme of measures applied by a competent authority which is aimed at ensuring that the provisions of this Code are met in practice.

*Composite packagings* means packagings consisting of an outer packaging and an inner receptacle so constructed that the inner receptacle and the outer packaging form an integral packaging. Once assembled, it remains thereafter an integrated single unit; it is filled, stored, transported and emptied as such.

*Confinement system*, for the transport of class 7 material, means the assembly of fissile material and packaging components specified by the designer and agreed to by the competent authority as intended to preserve criticality safety.

*Consignee* means any person, organization or Government which is entitled to take delivery of a consignment.

*Consignment* means any package or packages, or load of dangerous goods, presented by a consignor for transport.

*Consignor* means any person, organization or Government which prepares a consignment for transport.

*Containment system*, for the transport of class 7 material, means the assembly of components of the packaging specified by the designer as intended to retain the radioactive material during transport.

*Control temperature* means the maximum temperature at which certain substances (such as organic peroxides and self-reactive and related substances) can be safely transported during a prolonged period of time.

*Conveyance* means:

- .1 for transport by road or rail: any vehicle,
- .2 for transport by water: any ship, or any cargo space or defined deck area of a ship,
- .3 for transport by air: any aircraft.

*Crates* are outer packagings with incomplete surfaces.

*Criticality safety index (CSI) assigned to a package, overpack or freight container containing fissile material*, for the transport of class 7 material, means a number which is used to provide control over the accumulation of packages, overpacks or freight containers containing fissile material.

*Critical temperature* is the temperature above which the substance cannot exist in the liquid state.

*Cryogenic receptacles* are transportable thermally insulated receptacles for refrigerated liquefied gases, of a water capacity of not more than 1000 litres.

*Cylinders* are transportable pressure receptacles of a water capacity not exceeding 150 litres.

*Defined deck area* means the area, of the weather deck of a ship, or of a vehicle deck of a roll-on/roll-off ship, which is allocated for the stowage of dangerous goods.

*Design*, for the transport of class 7 material, means the description of special form radioactive material, low dispersible radioactive material, package or packaging which enables such an item to be fully identified.

## Part 1 – General provisions, definitions and training

The description may include specifications, engineering drawings, reports demonstrating compliance with regulatory requirements, and other relevant documentation.

*Drums* means flat-ended or convex-ended cylindrical packagings made of metal, fibreboard, plastics, plywood or other suitable materials. This definition also includes packagings of other shapes, such as round taper-necked packagings, or pail-shaped packagings. Wooden barrels and jerricans are not covered by this definition.

*Elevated temperature substance* means a substance which is transported or offered for transport:

- in the liquid state at a temperature at or above 100°C
- in the liquid state with a flashpoint above 60°C that is intentionally heated to a temperature above its flashpoint; or
- in the solid state at a temperature at or above 240°C.

*Emergency temperature* means the temperature at which emergency procedures shall be implemented.

*Exclusive use*, for the transport of class 7 material, means the sole use, by a single consignor, of a conveyance or of a large freight container, in respect of which all initial, intermediate and final loading and unloading is carried out in accordance with the directions of the consignor or consignee.

*Filling ratio* means the ratio of the mass of gas to the mass of water at 15°C that would fill completely a pressure receptacle fitted ready for use.

*Flashpoint* means the lowest temperature of a liquid at which its vapour forms an ignitable mixture with air.

*Foodstuff* includes foodstuffs, feeds or other edible substances intended for consumption by humans or animals

*Freight container* means an article of transport equipment that is of a permanent character and accordingly strong enough to be suitable for repeated use; specially designed to facilitate the transport of goods, by one or more modes of transport, without intermediate reloading; designed to be secured and/or readily handled, having fittings for these purposes, and approved in accordance with the International Convention for Safe Containers (CSC), 1972, as amended. The term "freight container" includes neither vehicle nor packaging. However, a freight container that is carried on a chassis is included.

For freight containers for the transport of radioactive material, a freight container may be used as a packaging. A small freight container is that which has either any overall outer dimension less than 1.5 m, or an internal volume of not more than 3 m<sup>3</sup>. Any other freight container is considered to be a large freight container.

*Fuel cell* means an electrochemical device that converts the chemical energy of a fuel to electrical energy, heat and reaction products.

*Fuel cell engine* means a device used to power equipment and which consists of a fuel cell and its fuel supply, whether integrated with or separate from the fuel cell, and includes all appurtenances necessary to fulfil its function.

*GHS* means the third revised edition of the *Globally Harmonized System of Classification and Labelling of Chemicals*, published by the United Nations as document ST/SG/AC.10/30/Rev.4.

*IMO type 4 tank* means a road tank vehicle for the transport of dangerous goods of classes 3 to 9 and includes a semi-trailer with a permanently attached tank or a tank attached to a chassis, with at least four twist locks that take account of ISO standards (i.e. ISO International Standard 1161:1984).

*IMO type 6 tank* means a road tank vehicle for the transport of non-refrigerated liquefied gases of class 2 and includes a semi-trailer with a permanently attached tank or a tank attached to a chassis which is fitted with items of service equipment and structural equipment necessary for the transport of gases.

*IMO type 8 tank* means a road tank vehicle for the transport of refrigerated liquefied gases of class 2 and includes a semi-trailer with a permanently attached thermally insulated tank fitted with items of service equipment and structural equipment necessary for the transport of refrigerated liquefied gases.

*Inner packagings* means packagings for which an outer packaging is required for transport.

*Inner receptacles* means receptacles which require an outer packaging in order to perform their containment function.

*Inspection body* means an independent inspection and testing body approved by the competent authority.

*Intermediate bulk containers (IBCs)* means rigid or flexible portable packagings, other than specified in chapter 6.1, that:

- .1 have a capacity of:
  - .1 not more than 3.0 m<sup>3</sup> (3000 litres) for solids and liquids of packing groups II and III;

- .2 not more than 1.5 m<sup>3</sup> for solids of packing group I when packed in flexible, rigid plastics, composite, fibreboard or wooden IBCs;
- .3 not more than 3.0 m<sup>3</sup> for solids of packing group I when packed in metal IBCs;
- .4 not more than 3.0 m<sup>3</sup> for radioactive material of class 7;
- .2 are designed for mechanical handling; and
- .3 are resistant to the stresses produced in handling and transport, as determined by tests.

*Remanufactured IBCs* are metal, rigid plastics or composite IBCs that:

- .1 are produced as a UN type from a non-UN type; or
- .2 are converted from one UN design type to another UN design type.

Remanufactured IBCs are subject to the same provisions of this Code that apply to new IBCs of the same type (see also design type definition in 6.5.6.1.1).

*Repaired IBCs* are metal, rigid plastics or composite IBCs that, as a result of impact or for any other cause (e.g. corrosion, embrittlement or other evidence of reduced strength as compared to the design type) are restored so as to conform to the design type and to be able to withstand the design type tests. For the purposes of this Code, the replacement of the rigid inner receptacle of a composite IBC with a receptacle conforming to the original design type from the same manufacturer is considered repair. However, routine maintenance of rigid IBCs (see definition below) is not considered repair. The bodies of rigid plastics IBCs and the inner receptacles of composite IBCs are not repairable. Flexible IBCs are not repairable, unless approved by the competent authority.

*Routine maintenance of flexible IBCs* is the routine performance on plastics or textile flexible IBCs of operations, such as:

- .1 cleaning; or
- .2 replacement of non-integral components, such as non-integral liners and closure ties, with components conforming to the original manufacturer's specification;

provided that these operations do not adversely affect the containment function of the flexible IBC or alter the design type.

**Note:** For rigid IBCs, see "Routine maintenance of rigid IBCs".

*Routine maintenance of rigid IBCs* is the routine performance on metal, rigid plastics or composite IBCs of operations such as:

- .1 cleaning;
- .2 removal and reinstallation or replacement of body closures (including associated gaskets), or of service equipment, conforming to the original manufacturer's specifications, provided that the leaktightness of the IBC is verified; or
- .3 restoration of structural equipment not directly performing a dangerous goods containment or discharge pressure retention function so as to conform to the design type (e.g. the straightening of legs or lifting attachments) provided that the containment function of the IBC is not affected.

**Note:** For flexible IBCs, see "Routine maintenance of flexible IBCs".

*Intermediate packagings* means packagings placed between inner packagings, or articles, and an outer packaging.

*Jerricans* means metal or plastics packagings of rectangular or polygonal cross-section.

*Large packagings* means packagings consisting of an outer packaging which contains articles or inner packagings and which:

- .1 are designed for mechanical handling; and
- .2 exceed 400 kg net mass or 450 ℓ capacity but have a volume of not more than 3 m<sup>3</sup>.

*Liner* means a separate tube or bag inserted into a packaging (including IBCs and large packagings) but not forming an integral part of it, including the closures of its openings.

*Liquids* are dangerous goods which at 50°C have a vapour pressure of not more than 300 kPa (3 bar), which are not completely gaseous at 20°C and at a pressure of 101.3 kPa, and which have a melting point or initial melting point of 20°C or less at a pressure of 101.3 kPa. A viscous substance for which a specific melting point cannot be determined shall be subjected to the ASTM D 4359-90 test; or to the test for determining fluidity (penetrometer test) prescribed in section 2.3.4 of Annex A of the European Agreement concerning the International Carriage of Dangerous Goods by Road (ADR), as amended.

*Long international voyage* means an international voyage that is not a short international voyage.

Part 1 – General provisions, definitions and training

---

*Manual of Tests and Criteria* means the fifth revised edition of the United Nations publication entitled “Recommendations on the Transport of Dangerous Goods, Manual of Tests and Criteria” (ST/SG/AC.10/11/Rev.5 as amended by ST/SG/AC.10/11/Rev.5/Amend.1).

*Maximum capacity* as used in 6.1.4 means the maximum inner volume of receptacles or packagings expressed in litres.

*Maximum net mass* as used in 6.1.4 means the maximum net mass of contents in a single packaging or maximum combined mass of inner packagings and the contents thereof and is expressed in kilograms.

*Maximum normal operating pressure*, for the transport of class 7 material, means the maximum pressure above atmospheric pressure at mean sea-level that would develop in the containment system in a period of one year under the conditions of temperature and solar radiation corresponding to environmental conditions in the absence of venting, external cooling by an ancillary system, or operational controls during transport.

*Metal hydride storage system* means a single complete hydrogen storage system, including a receptacle, metal hydride, pressure relief device, shut-off valve, service equipment and internal components used for the transport of hydrogen only.

*Multiple-element gas containers (MEGCs)* are multimodal assemblies of cylinders, tubes and bundles of cylinders which are interconnected by a manifold and which are assembled within a framework. The MEGC includes service equipment and structural equipment necessary for the transport of gases.

*Net explosive mass (NEM)* means the total mass of the explosive substances, without the packagings, casings, etc. (*Net explosive quantity (NEQ)*, *net explosive contents (NEC)*, or *net explosive weight (NEW)* are often used to convey the same meaning.)

*Offshore bulk container* means a bulk container specially designed for repeated use for the transport of dangerous goods to, from and between offshore facilities. An offshore bulk container is designed and constructed in accordance with MSC/Circ.860 “Guidelines for the approval of offshore containers handled in open seas”.

*Open cargo transport unit* means a unit which is not a closed cargo transport unit.

*Open cryogenic receptacle* means a transportable thermally insulated receptacle for refrigerated liquefied gases maintained at atmospheric pressure by continuous venting of the refrigerated liquefied gas.

*Open ro-ro cargo space* means a ro-ro cargo space either open at both ends, or open at one end and provided with adequate natural ventilation effective over its entire length through permanent openings in the side plating or deckhead to the satisfaction of the Administration.

*Outer packaging* means the outer protection of a composite or combination packaging together with any absorbent materials, cushioning and any other components necessary to contain and protect inner receptacles or inner packagings.

*Overpack* means an enclosure used by a single consignor to contain one or more packages and to form one unit for the convenience of handling and stowage during transport. Examples of overpacks are a number of packages either:

- .1 placed or stacked on to a load board, such as a pallet, and secured by strapping, shrink-wrapping, stretch-wrapping, or other suitable means; or
- .2 placed in a protective outer packaging such as a box or crate.

*Overstowed* means that a package or container is directly stowed on top of another.

*Package* means the complete product of the packing operation, consisting of the packaging and its contents prepared for transport.

*Packaging* means one or more receptacles and any other components or materials necessary for the receptacles to perform their containment and other safety functions.

*Pressure drums* are welded transportable pressure receptacles of a water capacity exceeding 150 litres and of not more than 1000 litres (e.g. cylindrical receptacles equipped with rolling hoops, spheres on skids).

*Pressure receptacles* is a collective term that includes cylinders, tubes, pressure drums, closed cryogenic receptacles, metal hydride storage systems, bundles of cylinders and salvage pressure receptacles.

*Quality assurance* means a systematic programme of controls and inspections applied by any organization or body which is aimed at providing adequate confidence that the standard of safety prescribed in this Code is achieved in practice.

*Radiation level*, for the transport of class 7 material, means the corresponding dose rate expressed in millisieverts per hour.

*Radioactive contents*, for the transport of class 7 material, mean the radioactive material together with any contaminated or activated solids, liquids, and gases within the packaging.

*Receptacles* means containment vessels for receiving and holding substances or articles, including any means of closing.

*Reconditioned packagings* include:

- .1 metal drums that:
  - .1 are cleaned to original materials of construction, with all former contents, internal and external corrosion, and external coatings and labels removed;
  - .2 are restored to original shape and contour, with chimes (if any) straightened and sealed, and all non-integral gaskets replaced; and
  - .3 are inspected after cleaning, but before painting, with rejection of packagings with visible pitting, significant reduction in material thickness, metal fatigue, damaged threads or closures, or other significant defects;
- .2 plastic drums and jerricans that:
  - .1 are cleaned to original materials of construction, with all former contents, external coatings and labels removed;
  - .2 have all non-integral gaskets replaced; and
  - .3 are inspected after cleaning, with rejection of packagings with visible damage such as tears, creases or cracks, or damaged threads or closures, or other significant defects.

*Recycled plastics material* means material recovered from used industrial packagings that has been cleaned and prepared for processing into new packagings. The specific properties of the recycled material used for production of new packagings shall be assured and documented regularly as part of a quality assurance programme recognized by the competent authority. The quality assurance programme shall include a record of proper pre-sorting and verification that each batch of recycled plastics material has the proper melt flow rate, density, and tensile yield strength, consistent with that of the design type manufactured from such recycled material. This necessarily includes knowledge about the packaging material from which the recycled plastics have been derived, as well as awareness of the prior contents of those packagings if those prior contents might reduce the capability of new packagings produced using that material. In addition, the packaging manufacturer's quality assurance programme under 6.1.1.3 shall include performance of the mechanical design type test in 6.1.5 on packagings manufactured from each batch of recycled plastics material. In this testing, stacking performance may be verified by appropriate dynamic compression testing rather than static load testing.

**Note:** ISO 16103:2005 "Packaging – Transport packages for dangerous goods – Recycled plastics material", provides additional guidance on procedures to be followed in approving the use of recycled plastics material.

*Remanufactured IBCs* (see *Intermediate bulk containers (IBCs)*).

*Remanufactured large packaging* means a metal or rigid plastics large packaging that:

- .1 is produced as a UN type from a non-UN type; or
- .2 is converted from one UN design type to another UN design type.

Remanufactured large packagings are subject to the same provisions of this Code that apply to new large packagings of the same type (see also design type definition in 6.6.5.1.2).

*Remanufactured packagings* include:

- .1 metal drums that:
  - .1 are produced as a UN type from a non-UN type;
  - .2 are converted from one UN type to another UN type; or
  - .3 undergo the replacement of integral structural components (such as non-removable heads); or
- .2 plastic drums that:
  - .1 are converted from one UN type to another UN type (such as 1H1 to 1H2); or
  - .2 undergo the replacement of integral structural components.

Remanufactured drums are subject to the same provisions of this Code that apply to a new drum of the same type.

*Repaired IBCs* (see *Intermediate bulk containers (IBCs)*).

*Re-used large packaging* means a large packaging to be refilled which has been examined and found free of defects affecting the ability to withstand the performance tests: the term includes those which are refilled with the same or similar compatible contents and are transported within distribution chains controlled by the consignor of the product.

Part 1 – General provisions, definitions and training

---

*Re-used packagings* means packagings to be refilled which have been examined and found free of defects affecting the ability to withstand the performance tests; the term includes those which are refilled with the same or similar compatible contents and are transported within distribution chains controlled by the consignor of the product.

*Road tank vehicle* means a vehicle equipped with a tank with a capacity of more than 450 litres, fitted with pressure-relief devices.

*Ro-ro cargo space* means spaces not normally subdivided in any way and extending to either a substantial length or the entire length of the ship in which goods (packaged or in bulk, in or on rail or road cars, vehicles (including road or rail tankers), trailers, containers, pallets, demountable tanks or in or on similar stowage units or other receptacles) can be loaded and unloaded normally in a horizontal direction.

*Ro-ro ship* (roll-on/roll-off ship) means a ship which has one or more decks, either closed or open, not normally subdivided in any way and generally running the entire length of the ship, carrying goods which are normally loaded and unloaded in a horizontal direction.

*Routine maintenance of IBCs* (see *Intermediate bulk containers (IBCs)*).

*Salvage packagings* are special packagings into which damaged, defective, leaking or non-conforming dangerous goods packages, or dangerous goods that have spilled or leaked, are placed for purposes of transport for recovery or disposal.

*Salvage pressure receptacle* means a pressure receptacle with a water capacity not exceeding 1 000 litres into which are placed damaged, defective, leaking or non conforming pressure receptacle(s) for the purpose of transport, e.g., for recovery or disposal.

*Self-accelerating decomposition temperature (SADT)* means the lowest temperature at which self-accelerating decomposition may occur for a substance in the packaging as used in transport. The self-accelerating decomposition temperature (SADT) shall be determined in accordance with the latest version of the United Nations *Manual of Tests and Criteria*.

*Semi-trailer* means any trailer designed to be coupled to a motor vehicle in such a way that part of it rests on the motor vehicle and a substantial part of its mass and of the mass of its load is borne by the motor vehicle.

*Settled pressure* means the pressure of the contents of a pressure receptacle in thermal and diffusive equilibrium.

*Shipborne barge* or *barge* means an independent, non-self-propelled vessel, specially designed and equipped to be lifted in a loaded condition and stowed aboard a barge-carrying ship or barge feeder vessel.

*Shipment* means the specific movement of a consignment from origin to destination.

*Shipper*, for the purpose of this Code, has the same meaning as *consignor*.

*Short international voyage* means an international voyage in the course of which a ship is not more than 200 miles from a port or place in which the passengers and crew could be placed in safety. Neither the distance between the last port of call in the country in which the voyage begins and the final port of destination nor the return voyage shall exceed 600 miles. The final port of destination is the last port of call in the scheduled voyage at which the ship commences its return voyage to the country in which the voyage began.

*Sift-proof packagings* are packagings impermeable to dry contents, including fine solid material produced during transport.

*Solid bulk cargo* means any material, other than liquid or gas, consisting of a combination of particles, granules or any larger pieces of material, generally uniform in composition, which is loaded directly into the cargo spaces of a ship without any intermediate form of containment (this includes a material loaded in a barge on a barge-carrying ship).

*Solids* are dangerous goods, other than gases, that do not meet the definition of *liquids* in this chapter.

*Special category space* means an enclosed space, above or below deck, intended for the transport of motor vehicles with fuel in their tanks for their own propulsion, into and from which such vehicles can be driven and to which passengers have access.

*Tank* means a portable tank (including a tank-container), a road tank-vehicle, a rail tank-wagon or a receptacle to contain solids, liquids, or liquefied gases and has a capacity of not less than 450 litres when used for the transport of gases as defined in 2.2.1.1.

*Test pressure* means the required pressure applied during a pressure test for qualification or requalification (for portable tanks, see 6.7.2.1).

*Through or into* means through or into the countries in which a consignment is transported but specifically excludes countries “over” which a consignment is carried by air, provided that there are no scheduled stops in those countries.

*Transboundary movement of wastes* means any shipment of wastes from an area under the national jurisdiction of one country to or through an area under the national jurisdiction of another country, or to or through an area not under the national jurisdiction of any country, provided at least two countries are concerned by the movement.

*Transport index (TI) assigned to a package, overpack or freight container, or to unpackaged LSA-I or SCO-I*, for the transport of class 7 material, means a number which is used to provide control over radiation exposure.

*Tubes* are seamless transportable pressure receptacles of a water capacity exceeding 150 litres and of not more than 3000 litres.

*Unit load* means that a number of packages are either:

- .1 placed or stacked on and secured by strapping, shrink-wrapping, or other suitable means to a load board, such as a pallet;
- .2 placed in a protective outer enclosure, such as a pallet box;
- .3 permanently secured together in a sling.

*Vehicle* means a road vehicle (including an articulated vehicle, i.e. a tractor and semi-trailer combination) or railroad car or railway wagon. Each trailer shall be considered as a separate vehicle.

*Wastes* means substances, solutions, mixtures, or articles containing or contaminated with one or more constituents which are subject to the provisions of this Code and for which no direct use is envisaged but which are transported for dumping, incineration, or other methods of disposal.

*Water-reactive* means a substance which, in contact with water, emits flammable gas.

*Weather deck* means a deck which is completely exposed to the weather from above and from at least two sides.

*Wooden barrels* means packagings made of natural wood, of round cross-section, having convex walls, consisting of staves and heads and fitted with hoops.

*Working pressure* means the settled pressure of a compressed gas at a reference temperature of 15°C in a full pressure receptacle.

#### 1.2.1.1 Clarifying examples for certain defined terms

The following explanations and examples are meant to assist in clarifying the use of some of the packaging terms defined in this chapter.

The definitions in this chapter are consistent with the use of the defined terms throughout the Code. However, some of the defined terms are commonly used in other ways. This is particularly evident in respect of the term “inner receptacle” which has often been used to describe the “inners” of a combination packaging.

The “inners” of “combination packagings” are always termed “inner packagings”, not “inner receptacles”. A glass bottle is an example of such an “inner packaging”.

The “inners” of “composite packagings” are normally termed “inner receptacles”. For example, the “inner” of a 6HA1 composite packaging (plastics material) is such an “inner receptacle” since it is normally not designed to perform a containment function without its “outer packaging” and is not, therefore, an “inner packaging”.

Part 1 – General provisions, definitions and training

**1.2.2 Units of measurement**

1.2.2.1 The following units of measurement\* are applicable in this Code:

Measurement of:	SI unit <sup>a</sup>	Acceptable alternative unit	Relationship between units
Length	m (metre)	–	–
Area	m <sup>2</sup> (square metre)	–	–
Volume	m <sup>3</sup> (cubic metre)	ℓ <sup>b</sup> (litre)	1 ℓ = 10 <sup>-3</sup> m <sup>3</sup>
Time	s (second)	min (minute)	1 min = 60 s
		h (hour)	1 h = 3600 s
		d (day)	1 d = 86400 s
Mass	kg (kilogram)	g (gram)	1 g = 10 <sup>-3</sup> kg
		t (ton)	1 t = 10 <sup>3</sup> kg
Mass density	kg/m <sup>3</sup>	kg/ℓ	1 kg/ℓ = 10 <sup>3</sup> kg/m <sup>3</sup>
Temperature	K (kelvin)	°C (degree Celsius)	0°C = 273.15 K
Difference of temperature	K (kelvin)	°C (degree Celsius)	1°C = 1 K
Force	N (newton)	–	1 N = 1 kg·m/s <sup>2</sup>
Pressure	Pa (pascal)	bar (bar)	1 bar = 10 <sup>5</sup> Pa
			1 Pa = 1 N/m <sup>2</sup>
Stress	N/m <sup>2</sup>	N/mm <sup>2</sup>	1 N/mm <sup>2</sup> = 1 MPa
Work	J (joule)	kWh (kilowatt hour)	1 kWh = 3.6 MJ
Energy			1 J = 1 N·m = 1 W·s
Quantity of heat			eV (electronvolt)
Power	W (watt)	–	1 W = 1 J/s = 1 N·m/s
Kinematic viscosity	m <sup>2</sup> /s	mm <sup>2</sup> /s	1 mm <sup>2</sup> /s = 10 <sup>-6</sup> m <sup>2</sup> /s
Dynamic viscosity	Pa·s	mPa·s	1 mPa·s = 10 <sup>-3</sup> Pa·s
Activity	Bq (becquerel)	–	–
Dose equivalent	Sv (sievert)	–	–
Conductivity	S/m (siemens/metre)	–	–

<sup>a</sup> The International System of Units (SI) is the result of decisions taken at the General Conference on Weights and Measures (Address: Pavillon de Breteuil, Parc de St-Cloud, F-92312 Sèvres).

<sup>b</sup> The abbreviation “L” for litre may also be used in place of the abbreviation “ℓ”, when a typewriter/word-processor cannot distinguish between figure “1” and letter “ℓ”.

\* The following round figures are applicable for the conversion of the units hitherto used into SI units.



<b>Force</b>	<b>Stress</b>		
1 kg = 9.807 N	1 kg/mm <sup>2</sup> = 9.807 N/mm <sup>2</sup>		
1 N = 0.102 kg	1 N/mm <sup>2</sup> = 0.102 kg/mm <sup>2</sup>		
<b>Pressure</b>			
1 Pa = 1 N/m <sup>2</sup> = 10 <sup>-5</sup> bar	= 1.02 × 10 <sup>-5</sup> kg/cm <sup>2</sup>	= 0.75 × 10 <sup>-2</sup> torr	
1 bar = 10 <sup>5</sup> Pa	= 1.02 kg/cm <sup>2</sup>	= 750 torr	
1 kg/cm <sup>2</sup> = 9.807 × 10 <sup>4</sup> Pa	= 0.9807 bar	= 736 torr	
1 torr = 1.33 × 10 <sup>2</sup> Pa	= 1.33 × 10 <sup>-3</sup> bar	= 1.36 × 10 <sup>-3</sup> kg/cm <sup>2</sup>	
<b>Energy, work, quantity of heat</b>			
1 J = 1 N·m	= 0.278 × 10 <sup>-6</sup> kWh	= 0.102 kg·m	= 0.239 × 10 <sup>-3</sup> kcal
1 kWh = 3.6 × 10 <sup>6</sup> J	= 367 × 10 <sup>3</sup> kg·m	= 860 kcal	
1 kg·m = 9.807 J	= 2.72 × 10 <sup>-6</sup> kWh	= 2.34 × 10 <sup>-3</sup> kcal	
1 kcal = 4.19 × 10 <sup>3</sup> J	= 1.16 × 10 <sup>-3</sup> kWh	= 427 kg·m	
<b>Power</b>		<b>Kinematic viscosity</b>	
1 W = 0.102 kg·m/s	= 0.86 kcal/h	1 m <sup>2</sup> /s = 10 <sup>4</sup> St (stokes)	
1 kg·m/s = 9.807 W	= 8.43 kcal/h	1 St = 10 <sup>-4</sup> m <sup>2</sup> /s	
1 kcal/h = 1.16 W	= 0.119 kg·m/s		
<b>Dynamic viscosity</b>			
1 Pa·s = 1 N·s/m <sup>2</sup>	= 10 P (poise)	= 0.102 kg·s/m <sup>2</sup>	
1 P = 0.1 Pa·s	= 0.1 N·s/m <sup>2</sup>	= 1.02 × 10 <sup>-2</sup> kg·s/m <sup>2</sup>	
1 kg·s/m <sup>2</sup> = 9.807 Pa·s	= 9.807 N·s/m <sup>2</sup>	= 98.07 P	

The decimal multiples and sub-multiples of a unit may be formed by prefixes or symbols, having the following meanings, placed before the name or symbol of the unit:

Multiplying factor		Prefix	Symbol
1 000 000 000 000 000 000 = 10 <sup>18</sup>	quintillion	exa	E
1 000 000 000 000 000 = 10 <sup>15</sup>	quadrillion	peta	P
1 000 000 000 000 = 10 <sup>12</sup>	trillion	tera	T
1 000 000 000 = 10 <sup>9</sup>	billion	giga	G
1 000 000 = 10 <sup>6</sup>	million	mega	M
1 000 = 10 <sup>3</sup>	thousand	kilo	k
100 = 10 <sup>2</sup>	hundred	hecto	h
10 = 10 <sup>1</sup>	ten	deca	da
0.1 = 10 <sup>-1</sup>	tenth	deci	d
0.01 = 10 <sup>-2</sup>	hundredth	centi	c
0.001 = 10 <sup>-3</sup>	thousandth	milli	m
0.000 001 = 10 <sup>-6</sup>	millionth	micro	μ
0.000 000 001 = 10 <sup>-9</sup>	billionth	nano	n
0.000 000 000 001 = 10 <sup>-12</sup>	trillionth	pico	p
0.000 000 000 000 001 = 10 <sup>-15</sup>	quadrillionth	femto	f
0.000 000 000 000 000 001 = 10 <sup>-18</sup>	quintillionth	atto	a

**Note:** 10<sup>9</sup> = 1 billion is United Nations usage in English. By analogy, so is 10<sup>-9</sup> = 1 billionth.

1.2.2.2 [Reserved]

1.2.2.3 Whenever the mass of a package is mentioned, the gross mass is meant unless otherwise stated. The mass of containers or tanks used for the transport of goods is not included in the gross mass.

1.2.2.4 Unless expressly stated otherwise, the sign “%” represents:

- .1 in the case of mixtures of solids or of liquids, and also in the case of solutions and of solids wetted by a liquid: a percentage mass based on the total mass of the mixture, the solution or the wetted solid;
- .2 in the case of mixtures of compressed gases: when filled by pressure, the proportion of the volume indicated as a percentage of the total volume of the gaseous mixture, or, when filled by mass, the proportion of the mass indicated as a percentage of the total mass of the mixture;
- .3 in the case of mixtures of liquefied gases and gases dissolved under pressure: the proportion of the mass indicated as a percentage of the total mass of the mixture.

*Part 1 – General provisions, definitions and training*

1.2.2.5 Pressures of all kinds relating to receptacles (such as test pressure, internal pressure, safety-valve opening pressure) are always indicated in gauge pressure (pressure in excess of atmospheric pressure); however, the vapour pressure of substances is always expressed in absolute pressure.

1.2.2.6 **Tables of equivalence**

1.2.2.6.1 **Mass conversion tables**

1.2.2.6.1.1 *Conversion factors*

<i>Multiply</i>	<i>by</i>	<i>to obtain</i>
Grams	0.03527	Ounces
Grams	0.002205	Pounds
Kilograms	35.2736	Ounces
Kilograms	2.2046	Pounds
Ounces	28.3495	Grams
Pounds	16	Ounces
Pounds	453.59	Grams
Pounds	0.45359	Kilograms
Hundredweight	112	Pounds
Hundredweight	50.802	Kilograms

1.2.2.6.1.2 *Pounds to kilograms and vice versa*

When the central value in any row of these mass conversion tables is taken to be in pounds, its equivalent value in kilograms is shown on the left; when the central value is in kilograms, its equivalent in pounds is shown on the right.

kg	←	→	kg	lb	kg	←	→	kg	lb	kg	←	→	kg	lb
0.227		0.5	1.10	22.7	50	110	90.7	200	441					
0.454		1	2.20	24.9	55	121	95.3	210	463					
0.907		2	4.41	27.2	60	132	99.8	220	485					
1.36		3	6.61	29.5	65	143	102	225	496					
1.81		4	8.82	31.8	70	154	104	230	507					
2.27		5	11.0	34.0	75	165	109	240	529					
2.72		6	13.2	36.3	80	176	113	250	551					
3.18		7	15.4	38.6	85	187	118	260	573					
3.63		8	17.6	40.8	90	198	122	270	595					
4.08		9	19.8	43.1	95	209	125	275	606					
4.54		10	22.0	45.4	100	220	127	280	617					
4.99		11	24.3	47.6	105	231	132	290	639					
5.44		12	26.5	49.9	110	243	136	300	661					
5.90		13	28.7	52.2	115	254	159	350	772					
6.35		14	30.9	54.4	120	265	181	400	882					
6.80		15	33.1	56.7	125	276	204	450	992					
7.26		16	35.3	59.0	130	287	227	500	1102					
7.71		17	37.5	61.2	135	298	247	545	1202					
8.16		18	39.7	63.5	140	309	249	550	1213					
8.62		19	41.9	65.8	145	320	272	600	1323					
9.07		20	44.1	68.0	150	331	318	700	1543					
11.3		25	55.1	72.6	160	353	363	800	1764					
13.6		30	66.1	77.1	170	375	408	900	1984					
15.9		35	77.2	79.4	175	386	454	1000	2205					
18.1		40	88.2	81.6	180	397								
20.4		45	99.2	86.2	190	419								

1.2.2.6.2 *Liquid measure conversion tables*

1.2.2.6.2.1 *Conversion factors*

<i>Multiply</i>	<i>by</i>	<i>to obtain</i>
Litres	0.2199	Imperial gallons
Litres	1.759	Imperial pints
Litres	0.2643	US gallons
Litres	2.113	US pints
Gallons	8	Pints
Imperial gallons	4.546	Litres
Imperial gallons } Imperial pints }	1.20095	{ US gallons { US pints
Imperial pints	0.568	Litres
US gallons	3.7853	Litres
US gallons } US pints }	0.83268	{ Imperial gallons { Imperial pints
US pints	0.473	Litres

1.2.2.6.2.2 *Imperial pints to litres and vice versa*

When the central value in any row of these liquid measure conversion tables is taken to be in pints, its equivalent value in litres is shown on the left; when the central value is in litres, its equivalent in pints is shown on the right.

<i>ℓ</i>	← <b>pt</b>	→ <i>ℓ</i>	<b>pt</b>
0.28	0.5		0.88
0.57	1		1.76
0.85	1.5		2.64
1.14	2		3.52
1.42	2.5		4.40
1.70	3		5.28
1.99	3.5		6.16
2.27	4		7.04
2.56	4.5		7.92
2.84	5		8.80
3.12	5.5		9.68
3.41	6		10.56
3.69	6.5		11.44
3.98	7		12.32
4.26	7.5		13.20
4.55	8		14.08

*Part 1 – General provisions, definitions and training*

**1.2.2.6.2.3 Imperial gallons to litres and vice versa**

When the central value in any row of these liquid measure conversion tables is taken to be in gallons, its equivalent value in litres is shown on the left; when the central value is in litres, its equivalent in gallons is shown on the right.

$\ell$	← gal	→ $\ell$	gal	$\ell$	← gal	→ $\ell$	gal
2.27	0.5	0.11	159.11	35	7.70		
4.55	1	0.22	163.65	36	7.92		
9.09	2	0.44	168.20	37	8.14		
13.64	3	0.66	172.75	38	8.36		
18.18	4	0.88	177.29	39	8.58		
22.73	5	1.10	181.84	40	8.80		
27.28	6	1.32	186.38	41	9.02		
31.82	7	1.54	190.93	42	9.24		
36.37	8	1.76	195.48	43	9.46		
40.91	9	1.98	200.02	44	9.68		
45.46	10	2.20	204.57	45	9.90		
50.01	11	2.42	209.11	46	10.12		
54.55	12	2.64	213.66	47	10.34		
59.10	13	2.86	218.21	48	10.56		
63.64	14	3.08	222.75	49	10.78		
68.19	15	3.30	227.30	50	11.00		
72.74	16	3.52	250.03	55	12.09		
77.28	17	3.74	272.76	60	13.20		
81.83	18	3.96	295.49	65	14.29		
86.37	19	4.18	318.22	70	15.40		
90.92	20	4.40	340.95	75	16.49		
95.47	21	4.62	363.68	80	17.60		
100.01	22	4.84	386.41	85	18.69		
104.56	23	5.06	409.14	90	19.80		
109.10	24	5.28	431.87	95	20.89		
113.65	25	5.50	454.60	100	22.00		
118.19	26	5.72	613.71	135	29.69		
122.74	27	5.94	681.90	150	32.98		
127.29	28	6.16	909.20	200	43.99		
131.83	29	6.38	1022.85	225	49.48		
136.38	30	6.60	1136.50	250	54.97		
140.92	31	6.82	1363.80	300	65.99		
145.47	32	7.04	1591.10	350	76.96		
150.02	33	7.26	1818.40	400	87.99		
154.56	34	7.48	2045.70	450	98.95		

1.2.2.6.3 Temperature conversion tables

Degrees Fahrenheit to degrees Celsius and vice versa

When the central value in any row of these temperature conversion tables is taken to be in °F, its equivalent value in °C is shown on the left; when the central value is in °C, its equivalent in °F is shown on the right.

General formula:  $^{\circ}\text{F} = (^{\circ}\text{C} \times \frac{9}{5}) + 32$ ;  $^{\circ}\text{C} = (^{\circ}\text{F} - 32) \times \frac{5}{9}$

°C	←	→	°F	°C	←	→	°F	°C	←	→	°F
	°F	°C			°F	°C			°F	°C	
-73.3	-100	-148	-21.1	-6	21.2	1.1	34	93.2			
-67.8	-90	-130	-20.6	-5	23.0	1.7	35	95			
-62.2	-80	-112	-20.0	-4	24.8	2.2	36	96.8			
-56.7	-70	-94	-19.4	-3	26.6	2.8	37	98.6			
-51.1	-60	-76	-18.9	-2	28.4	3.3	38	100.4			
-45.6	-50	-58	-18.3	-1	30.2	3.9	39	102.2			
-40	-40	-40	-17.8	0	32.0	4.4	40	104			
-39.4	-39	-38.2	-17.2	1	33.8	5	41	105.8			
-38.9	-38	-36.4	-16.7	2	35.6	5.6	42	107.6			
-38.3	-37	-34.6	-16.1	3	37.4	6.1	43	109.4			
-37.8	-36	-32.8	-15.6	4	39.2	6.7	44	111.2			
-37.2	-35	-31	-15.0	5	41.0	7.2	45	113			
-36.7	-34	-29.2	-14.4	6	42.8	7.8	46	114.8			
-36.1	-33	-27.4	-13.9	7	44.6	8.3	47	116.6			
-35.6	-32	-25.6	-13.3	8	46.4	8.9	48	118.4			
-35	-31	-23.8	-12.8	9	48.2	9.4	49	120.2			
-34.4	-30	-22	-12.2	10	50.0	10.0	50	122.0			
-33.9	-29	-20.2	-11.7	11	51.8	10.6	51	123.8			
-33.3	-28	-18.4	-11.1	12	53.6	11.1	52	125.6			
-32.8	-27	-16.6	-10.6	13	55.4	11.7	53	127.4			
-32.2	-26	-14.8	-10.0	14	57.2	12.2	54	129.2			
-31.7	-25	-13	-9.4	15	59.0	12.8	55	131.0			
-31.1	-24	-11.2	-8.9	16	60.8	13.3	56	132.8			
-30.6	-23	-9.4	-8.3	17	62.6	13.9	57	134.6			
-30	-22	-7.6	-7.8	18	64.4	14.4	58	136.4			
-29.4	-21	-5.8	-7.2	19	66.2	15.0	59	138.2			
-28.9	-20	-4	-6.7	20	68	15.6	60	140.0			
-28.3	-19	-2.2	-6.1	21	69.8	16.1	61	141.8			
-27.8	-18	-0.4	-5.6	22	71.6	16.7	62	143.6			
-27.2	-17	1.4	-5	23	73.4	17.2	63	145.4			
-26.7	-16	3.2	-4.4	24	75.2	17.8	64	147.2			
-26.1	-15	5	-3.9	25	77	18.3	65	149.0			
-25.6	-14	6.8	-3.3	26	78.8	18.9	66	150.8			
-25.0	-13	8.6	-2.8	27	80.6	19.4	67	152.6			
-24.4	-12	10.4	-2.2	28	82.4	20.0	68	154.4			
-23.9	-11	12.2	-1.7	29	84.2	20.6	69	156.2			
-23.3	-10	14.0	-1.1	30	86	21.1	70	158.0			
-22.8	-9	15.8	-0.6	31	87.8	21.7	71	159.8			
-22.2	-8	17.6	0	32	89.6	22.2	72	161.6			
-21.7	-7	19.4	0.6	33	91.4	22.8	73	163.4			

**Part 1 – General provisions, definitions and training**

°C	← °F →	°C	°F	°C	← °F →	°C	°F	°C	← °F →	°C	°F
23.3	74	165.2	37.8	100	212	52.2	126	258.8			
23.9	75	167.0	38.3	101	213.8	52.8	127	260.6			
24.4	76	168.8	38.9	102	215.6	53.3	128	262.4			
25.0	77	170.6	39.4	103	217.4	53.9	129	264.2			
25.6	78	172.4	40	104	219.2	54.4	130	266.0			
26.1	79	174.2	40.6	105	221	55.0	131	267.8			
26.7	80	176.0	41.1	106	222.8	55.6	132	269.6			
27.2	81	177.8	41.7	107	224.6	56.1	133	271.4			
27.8	82	179.6	42.2	108	226.4	56.7	134	273.2			
28.3	83	181.4	42.8	109	228.2	57.2	135	275.0			
28.9	84	183.2	43.3	110	230	57.8	136	276.8			
29.4	85	185	43.9	111	231.8	58.3	137	278.6			
30	86	186.8	44.4	112	233.6	58.9	138	280.4			
30.6	87	188.6	45	113	235.4	59.4	139	282.2			
31.1	88	190.4	45.6	114	237.2	60.0	140	284.0			
31.7	89	192.2	46.1	115	239.0	65.6	150	302.0			
32.2	90	194	46.7	116	240.8	71.1	160	320.0			
32.8	91	195.8	47.2	117	242.6	76.7	170	338.0			
33.3	92	197.6	47.8	118	244.4	82.2	180	356.0			
33.9	93	199.4	48.3	119	246.2	87.8	190	374.0			
34.4	94	201.2	48.9	120	248.0	93.3	200	392.0			
35	95	203	49.4	121	249.8	98.9	210	410.0			
35.6	96	204.8	50.0	122	251.6	104.4	220	428.0			
36.1	97	206.6	50.6	123	253.4	110.0	230	446.0			
36.7	98	208.4	51.1	124	255.2	115.6	240	464.0			
37.2	99	210.2	51.7	125	257.0	121.1	250	482.0			

**1.2.3 List of abbreviations**

ASTM	American Society for Testing and Materials (ASTM International, 100 Barr Harbor Drive, P.O. Box C700, West Conshohocken, PA, 19428-2959, United States of America)
CGA	Compressed Gas Association (CGA, 4221 Walney Road, 5th Floor, Chantilly VA 20151-2923, United States of America)
CSC	International Convention for Safe Containers, 1972, as amended
DSC	IMO Sub-Committee on Dangerous Goods, Solid Cargoes and Containers
ECOSOC	Economic and Social Council (UN)
EmS	The EmS Guide: Emergency Response procedures for Ships Carrying Dangerous Goods
EN (standard)	European standard published by the European Committee for Standardization (CEN) (CEN, 36 rue de Stassart, B-1050 Brussels, Belgium)
FAO	Food and Agriculture Organization (FAO; Viale delle Terme di Caracalla, 00100 Rome, Italy)
HNS Convention	International Convention on Liability and Compensation for Damage in Connection with the Transport of Hazardous and Noxious Substances (IMO)
IAEA	International Atomic Energy Agency (IAEA, P.O. Box 100, A – 1400 Vienna, Austria)
ICAO	International Civil Aviation Organization (ICAO, 999 University Street, Montreal, Quebec H3C 5H7, Canada)
IEC	International Electrotechnical Commission (IEC, 3 rue de Varembe, P.O. Box 131, CH-1211 Geneva 20, Switzerland)
ILO	International Labour Organization/Office (ILO, 4 route des Morillons, CH-1211 Geneva 22, Switzerland)

**Chapter 1.2 – Definitions, units of measurement and abbreviations**

IMGS	International Medical Guide for Ships
IMO	International Maritime Organization (IMO, 4 Albert Embankment, London SE1 7SR, United Kingdom)
IMDG Code	International Maritime Dangerous Goods Code
IMSBC Code	International Maritime Solid Bulk Cargoes Code
INF Code	International Code for the Safe Carriage of Packaged Irradiated Nuclear Fuel, Plutonium and High-Level Radioactive Wastes on board Ships
ISO (standard)	An international standard published by the International Organization for Standardization (ISO, 1, ch. de la Voie-Creuse, CH-1211 Geneva 20, Switzerland)
MARPOL 73/78	International Convention for the Prevention of Pollution from Ships, 1973/78, as amended
MAWP	Maximum allowable working pressure
MEPC	Marine Environment Protection Committee (IMO)
MFAG	Medical First Aid guide for use in Accidents Involving Dangerous Goods
MSC	Maritime Safety Committee (IMO)
N.O.S.	not otherwise specified
SADT	Self-accelerating decomposition temperature
SOLAS 74	International Convention for the Safety of Life at Sea, 1974, as amended
UNECE	United Nations Economic Commission for Europe (UNECE, Palais des Nations, 8–14 avenue de la Paix, CH-1211 Geneva 10, Switzerland)
UN Number	Four-digit United Nations Number is assigned to dangerous, hazardous and harmful substances, materials and articles most commonly transported
UNEP	United Nations Environment Programme (United Nations Avenue, Gigiri, PO Box 30552, 00100, Nairobi, Kenya)
UNESCO/IOC	UN Educational, Scientific and Cultural Organization/Intergovernmental Oceanographic Commission (UNESCO/IOC, 1 rue Miollis, 75732 Paris Cedex 15, France)
WHO	World Health Organization (Avenue Appia 20, CH-1211 Geneva 27, Switzerland)
WMO	World Meteorological Organization (WMO, 7bis, avenue de la Paix, Case postale No. 2300, CH-1211 Geneva 2, Switzerland)

## Chapter 1.3

### Training

#### 1.3.0 Introductory note

The successful application of regulations concerning the transport of dangerous goods and the achievement of their objectives are greatly dependent on the appreciation by all persons concerned of the risks involved and on a detailed understanding of the regulations. This can only be achieved by properly planned and maintained initial and retraining programmes for all persons concerned with the transport of dangerous goods. The provisions of paragraphs 1.3.1.4 to 1.3.1.7 remain recommendatory (see 1.1.1.5).

#### 1.3.1 Training of shore-side personnel

**1.3.1.1** Shore-based personnel\* engaged in the transport of dangerous goods intended to be transported by sea shall be trained in the contents of dangerous goods provisions commensurate with their responsibilities. Employees shall be trained in accordance with the provisions of 1.3.1 before assuming responsibilities and shall only perform functions, for which required training has not yet been provided, under the direct supervision of a trained person. Training requirements specific to security of dangerous goods in chapter 1.4 shall also be addressed.

Entities engaging shore-based personnel in such activities shall determine which staff will be trained, what levels of training they require and the training methods used to enable them to comply with the provisions of the IMDG Code. This training shall be provided or verified upon employment in a position involving dangerous goods transport. For personnel who have not yet received the required training, the entities shall ensure that those personnel may only perform functions under the direct supervision of a trained person. The training shall be periodically supplemented with refresher training to take account of changes in regulations and practice. The competent authority, or its authorized body, may audit the entity to verify the effectiveness of the system in place, in providing training of staff commensurate with their role and responsibilities in the transport chain.

**1.3.1.2** Shore-based personnel such as those who:

- classify dangerous goods and identify Proper Shipping Names of dangerous goods;
- pack dangerous goods;
- mark, label or placard dangerous goods;
- load/unload Cargo Transport Units;
- prepare transport documents for dangerous goods;
- offer dangerous goods for transport;
- accept dangerous goods for transport;
- handle dangerous goods in transport;
- prepare dangerous goods loading/stowage plans;
- load/unload dangerous goods into/from ships;
- carry dangerous goods in transport;
- enforce or survey or inspect for compliance with applicable rules and regulations; or
- are otherwise involved in the transport of dangerous goods as determined by the competent authority

shall be trained in the following:

**1.3.1.2.1** *General awareness/familiarization training:*

- .1 each person shall be trained in order to be familiar with the general provisions of dangerous goods transport provisions;

\* For the training of officers and ratings responsible for cargo handling on ships carrying dangerous and hazardous substances in solid form in bulk, or in packaged form, see the STCW Code, as amended.



- .2 such training shall include a description of the classes of dangerous goods; labelling, marking, placarding, packing, stowage, segregation and compatibility provisions; a description of the purpose and content of the dangerous goods transport documents (such as the Multimodal Dangerous Goods Form and the Container/Vehicle Packing Certificate); and a description of available emergency response documents.

**1.3.1.2.2** *Function-specific training:* Each person shall be trained in specific dangerous goods transport provisions which are applicable to the function that person performs. An indicative list, for guidance purposes only, of some of the functions typically found in dangerous goods transport operations by sea and training requirements is given in paragraph 1.3.1.6.

**1.3.1.3** Records of training received according to this chapter shall be kept by the employer and made available to the employee or competent authority, upon request. Records shall be kept by the employer for a period of time established by the competent authority.

**1.3.1.4** *Safety training:* Commensurate with the risk of exposure in the event of a release and the functions performed, each person should be trained in:

- .1 methods and procedures for accident avoidance, such as proper use of package-handling equipment and appropriate methods of stowage of dangerous goods;
- .2 available emergency response information and how to use it;
- .3 general dangers presented by the various classes of dangerous goods and how to prevent exposure to those hazards, including, if appropriate, the use of personal protective clothing and equipment; and
- .4 immediate procedures to be followed in the event of an unintentional release of dangerous goods, including any emergency response procedures for which the person is responsible and personal protection procedures to be followed.

**1.3.1.5 Recommended training needs for shore-side personnel involved in the transport of dangerous goods under the IMDG Code**

The following indicative table is for information purposes only as every entity is arranged differently and may have varied roles and responsibilities within that entity.

Function	Specific training requirements	Numbers in this column refer to the list of related codes and publications in 1.3.1.7
1 Classify dangerous goods and identify Proper Shipping Name	Classification requirements, in particular <ul style="list-style-type: none"> <li>– the structure of the description of substances</li> <li>– the classes of dangerous goods and the principles of their classification</li> <li>– the nature of the dangerous substances and articles transported (their physical, chemical and toxicological properties)</li> <li>– the procedure for classifying solutions and mixtures</li> <li>– identification by Proper Shipping Name</li> <li>– use of Dangerous Goods List</li> </ul>	.1, .4, .5 and .12
2 Pack dangerous goods	Classes Packaging requirements <ul style="list-style-type: none"> <li>– type of packages (IBC, large packaging, tank container and bulk container)</li> <li>– UN marking for approved packagings</li> <li>– segregation requirements</li> <li>– limited quantities and excepted quantities</li> </ul> Marking and labelling First aid measures Emergency response procedures Safe handling procedures	.1 and .4
3 Mark, label or placard dangerous goods	Classes Marking, labelling and placarding requirements <ul style="list-style-type: none"> <li>– primary and subsidiary risk labels</li> <li>– marine pollutants</li> <li>– limited quantities and excepted quantities</li> </ul>	.1

Part 1 – General provisions, definitions and training

Function	Specific training requirements	Numbers in this column refer to the list of related codes and publications in 1.3.1.7
4 Load/unload cargo transport units	Documentation Classes Marking, labelling and placarding Stowage requirements, where applicable Segregation requirements Cargo securing requirements (as contained in the IMO/ILO/UNECE Guidelines) Emergency response procedures First aid measures CSC requirements Safe handling procedures	.1, .6, .7 and .8
5 Prepare transport documents for dangerous goods	Documentation requirements <ul style="list-style-type: none"> <li>- transport document</li> <li>- container/vehicle packing certificate</li> <li>- competent authorities' approval</li> <li>- waste transport documentation</li> <li>- special documentation, where appropriate</li> </ul>	.1
6 Offer dangerous goods for transport	Thorough knowledge of the IMDG Code Local requirements at loading and discharge ports <ul style="list-style-type: none"> <li>- port byelaws</li> <li>- national transport regulations</li> </ul>	.1 to .10 and .12
7 Accept dangerous goods for transport	Thorough knowledge of the IMDG Code Local requirements at loading, transiting and discharge ports <ul style="list-style-type: none"> <li>- port byelaws, in particular quantity limitations</li> <li>- national transport regulations</li> </ul>	.1 to .12
8 Handle dangerous goods in transport	Classes and their hazards Marking, labelling and placarding Emergency response procedures First aid measures Safe handling procedures such as <ul style="list-style-type: none"> <li>- use of equipment</li> <li>- appropriate tools</li> <li>- safe working loads</li> </ul> CSC requirements, local requirements at loading, transit and discharge ports Port byelaws, in particular, quantity limitation National transport regulations	.1, .2, .3, .6, .7, .8 and .10
9 Prepare dangerous goods loading/stowage plans	Documentation Classes Stowage requirements Segregation requirements Document of compliance Relevant IMDG Code parts, local requirements at loading, transit and discharge ports Port byelaws, in particular, quantity limitations	.1, .10, .11 and .12
10 Load/unload dangerous goods into/from ships	Classes and their hazards Marking, labelling and placarding Emergency response procedures First aid measures Safe handling procedures such as <ul style="list-style-type: none"> <li>- use of equipment</li> <li>- appropriate tools</li> <li>- safe working loads</li> </ul> Cargo securing requirements CSC requirements, local requirements at loading, transit and discharge ports Port byelaws, in particular, quantity limitation National transport regulations	.1, .2, .3, .7, .9, .10 and .12

Function	Specific training requirements	Numbers in this column refer to the list of related codes and publications in 1.3.1.7
11 Carry dangerous goods	Documentation Classes Marking, labelling and placarding Stowage requirements, where applicable Segregation requirements Local requirements at loading, transit and discharge ports <ul style="list-style-type: none"> <li>- port byelaws, in particular, quantity limitations</li> <li>- national transport regulations</li> </ul> Cargo securing requirements (as contained in the IMO/ILO/UNECE Guidelines) Emergency response procedures First aid measures CSC requirements Safe handling procedures	.1, .2, .3, .6, .7, .10, .11 and .12
12 Enforce or survey or inspect for compliance with applicable rules and regulations	Knowledge of IMDG Code and relevant guidelines and safety procedures	.1 to .13
13 Are otherwise involved in the transport of dangerous goods, as determined by the competent authority	As required by the competent authority commensurate with the task assigned	-

**1.3.1.6 Indicative table describing sections of the IMDG Code or other relevant instruments that may be appropriate to be considered in any training for the transport of dangerous goods**

Function	IMDG Code part / section																SOLAS chapter II-2/19	Port byelaws	National transport regulations	CSC	Guidelines for packing of cargo transport units	Emergency response procedures	First aid measures	Safe handling procedures				
	1	2	2.0	3	4	5	6	6*	7.1	7.2	7.3	7.4	7.5	7.6	7.7	7.8									7.9			
	1 Classify	X	X		X	X	X																			X		
2 Pack	X		X	X	X	X	X			X	X						X								X	X	X	
3 Mark, label, placard			X	X	X																							
4 Load/unload cargo transport units	X		X	X	X	X		X		X	X										X	X		X	X	X		
5 Prepare transport documents	X		X	X		X											X								X	X		
6 Offer for transport	X	X		X	X	X	X		X	X	X	X	X	X	X	X	X	X	X	X	X	X	X	X	X	X	X	
7 Accept for transport	X	X		X	X	X	X		X	X	X	X	X	X	X	X	X	X	X	X	X	X	X	X	X	X	X	
8 Handle in transport	X		X	X	X		X		X		X							X	X	X				X	X	X		
9 Prepare loading/stowage plans	X		X	X	X	X			X	X	X	X	X	X	X	X	X	X	X					X				
10 Load/unload from ships	X	X		X	X					X				X			X	X			X	X		X	X	X	X	
11 Carry	X		X	X	X	X		X	X	X	X	X	X	X	X	X	X	X	X	X	X	X	X	X	X	X	X	

**Remarks:**

\*Only sections 6.1.2, 6.1.3, 6.5.2, 6.6.3, 6.7.2.20, 6.7.3.16 and 6.7.4.15 apply

- 1.3.1.7 Related Codes and publications which may be appropriate for function-specific training
- .1 International Maritime Dangerous Goods (IMDG) Code, as amended
  - .2 The EmS Guide: Emergency Response Procedures for Ships Carrying Dangerous Goods (EmS), as amended
  - .3 Medical First Aid Guide for Use in Accidents Involving Dangerous Goods (MFAG), as amended
  - .4 United Nations Recommendations on the Transport of Dangerous Goods – Model Regulations, as amended
  - .5 United Nations Recommendations on the Transport of Dangerous Goods – Manual of Tests and Criteria, as amended
  - .6 IMO/ILO/UNECE Guidelines for Packing of Cargo Transport Units (CTUs)
  - .7 Recommendations on the Safe Transport of Dangerous Cargoes and Related Activities in Port Areas
  - .8 International Convention for Safe Containers (CSC), 1972, as amended
  - .9 Code of Safe Practice for Cargo Stowage and Securing (CSS Code), as amended
  - .10 MSC.1/Circ.1265 Recommendations on the safe use of pesticides in ships applicable to the fumigation of cargo transport units\*
  - .11 International Convention for the Safety of Life at Sea (SOLAS) 1974, as amended
  - .12 International Convention for the Prevention of Pollution from Ships 1973 as modified by the Protocol of 1978 (MARPOL 73/78), as amended.
  - .13 MSC.1/Circ.[...] Inspection programmes for cargo transport units carrying dangerous goods.

---

\* At its eighty-seventh session, in May 2010, the Maritime Safety Committee of the IMO approved Revised Recommendations on the safe use of pesticides in ships applicable to the fumigation of cargo transport units (MSC.1/Circ.1361), which supersedes MSC.1/Circ.1265.

## Chapter 1.4

### *Security provisions*

#### **1.4.0 Scope**

1.4.0.1 The provisions of this chapter address the security of dangerous goods in transport by sea. National competent authorities may apply additional security provisions, which should be considered when offering or transporting dangerous goods. The provisions of this chapter remain recommendatory except 1.4.1.1 (see 1.1.1.5).

1.4.0.2 The provisions of 1.4.2 and 1.4.3 do not apply to:

- .1 UN 2908 and UN 2909 excepted packages;
- .2 UN 2910 and UN 2911 excepted packages with an activity level not exceeding the A2 value; and
- .3 UN 2912 LSA-I and UN 2913 SCO-I.

#### **1.4.1 General provisions for companies, ships and port facilities\***

1.4.1.1 The relevant provisions of chapter XI-2 of SOLAS 74, as amended, and of part A of the International Ship and Port Facility Security (ISPS) Code apply to companies, ships and port facilities engaged in the transport of dangerous goods and to which regulation XI-2 of SOLAS 74, as amended, apply taking into account the guidance given in part B of the ISPS Code.

1.4.1.2 For cargo ships of less than 500 gross tons engaged in the transport of dangerous goods, it is recommended that Contracting Governments to SOLAS 74, as amended, consider security provisions for these cargo ships.

1.4.1.3 Any shore-based company personnel, ship-based personnel and port facility personnel engaged in the transport of dangerous goods should be aware of the security requirements for such goods, in addition to those specified in the ISPS Code, and commensurate with their responsibilities.

1.4.1.4 The training of the company security officer, shore-based company personnel having specific security duties, port facility security officer and port facility personnel having specific duties, engaged in the transport of dangerous goods, should also include elements of security awareness related to those goods.

1.4.1.5 All shipboard personnel and port facility personnel who are not mentioned in 1.4.1.4 and are engaged in the transport of dangerous goods should be familiar with the provisions of the relevant security plans related to those goods, commensurate with their responsibilities.

#### **1.4.2 General provisions for shore-side personnel**

1.4.2.1 For the purpose of this subsection, shore-side personnel covers individuals mentioned in 1.3.1.2. However, the provisions of 1.4.2 do not apply to:

- the company security officer and appropriate shore-based company personnel mentioned in 13.1 of part A of the ISPS Code,
- the ship security officer and the shipboard personnel mentioned in 13.2 and 13.3 of part A of the ISPS Code,
- the port facility security officer, the appropriate port facility security personnel and the port facility Personnel having specific security duties mentioned in 18.1 and 18.2 of part A of the ISPS Code.

For the training of those officers and personnel, refer to the International Ship and Port Facility Security (ISPS) Code.

\* Refer to MSC.1/Circ.1341 on Guidelines on security-related training and familiarization for port facility personnel and to MSC.1/Circ.1188 on Guidelines on training and certification for port facility security officers.

*Part 1 – General provisions, definitions and training*

---

- 1.4.2.2 Shore-side personnel engaged in transport by sea of dangerous goods should consider security provisions for the transport of dangerous goods commensurate with their responsibilities.
- 1.4.2.3 **Security training**
- 1.4.2.3.1 The training of shore-side personnel, as specified in chapter 1.3, shall also include elements of security awareness.
- 1.4.2.3.2 Security awareness training should address the nature of security risks, recognizing security risks, methods to address and reduce risks and actions to be taken in the event of a security breach. It should include awareness of security plans (if appropriate, refer to 1.4.3) commensurate with the responsibilities of individuals and their part in implementing security plans.
- 1.4.2.3.3 Such training should be provided or verified upon employment in a position involving dangerous goods transport and should be periodically supplemented with retraining.
- 1.4.2.3.4 Records of all security training received should be kept by the employer and made available to the employee or competent authority, upon request. Records should be kept by the employer for a period of time established by the competent authority.

**1.4.3 Provisions for high consequence dangerous goods**

**1.4.3.1 Definition of high consequence dangerous goods**

- 1.4.3.1.1 High consequence dangerous goods are those which have the potential for misuse in a terrorist event and which may, as a result, produce serious consequences such as mass casualties, mass destruction or, particularly for Class 7, mass socio-economic disruption.
- 1.4.3.1.2 An indicative list of high consequence dangerous goods in classes and divisions other than Class 7 is given in Table 1.4.1 below.

Table 1.4.1 : Indicative list of high consequence dangerous goods

Class 1, Division 1.1	explosives
Class 1, Division 1.2	explosives
Class 1, Division 1.3	compatibility group C explosives
Class 1, Division 1.4	UN Nos. 0104, 0237, 0255, 0267, 0289, 0361, 0365, 0366, 0440, 0441, 0455, 0456 and 0500
Class 1, Division 1.5	explosives
Class 2.1	Flammable gases in quantities greater than 3000 ℓ in a road tank vehicle, a railway tank wagon or a portable tank
Class 2.3	Toxic gases
Class 3	Flammable liquids of packing groups I and II in quantities greater than 3000 ℓ in a road tank vehicle, a railway tank wagon or a portable tank
Class 3	Desensitized liquid explosives
Class 4.1	Desensitized solid explosives
Class 4.2	Goods of packing group I in quantities greater than 3000 kg or 3000 ℓ in a road tank vehicle, a railway tank wagon, a portable tank or a bulk container
Class 4.3	Goods of packing group I in quantities greater than 3000 kg or 3000 ℓ in a road tank vehicle, a railway tank wagon, a portable tank or a bulk container
Class 5.1	Oxidizing liquids of packing group I in quantities greater than 3000 ℓ in a road tank vehicle, a railway tank wagon or a portable tank
Class 5.1	Perchlorates, ammonium nitrate, ammonium nitrate fertilizers and ammonium nitrate emulsions or suspensions or gels in quantities greater than 3000 kg or 3000 ℓ in a road tank vehicle, a railway tank wagon, a portable tank or a bulk container
Class 6.1	Toxic substances of packing group I
Class 6.2	Infectious substances of category A (UN Nos. 2814 and 2900)

Class 8 Corrosive substances of packing group I in quantities greater than 3000 kg or 3000 ℓ in a road tank vehicle, a railway tank wagon, a portable tank or a bulk container

1.4.3.1.3 For dangerous goods of Class 7, high consequence radioactive material is that with an activity equal to or greater than a transport security threshold of 3 000 A<sub>2</sub> per single package (see also 2.7.2.2.1) except for the following radionuclides where the transport security threshold is given in Table 1.4.2 below.

Table 1.4.2 – Transport security thresholds for specific radionuclides

Element	Radionuclide	Transport security threshold (TBq)
Americium	Am-241	0.6
Gold	Au-198	2
Cadmium	Cd-109	200
Californium	Cf-252	0.2
Curium	Cm-244	0.5
Cobalt	Co-57	7
Cobalt	Co-60	0.3
Cesium	Cs-137	1
Iron	Fe-55	8000
Germanium	Ge-68	7
Gadolinium	Gd-153	10
Iridium	Ir-192	0.8
Nickel	Ni-63	600
Paladium	Pd-103	900
Promethium	Pm-147	400
Polonium	Po-210	0.6
Plutonium	Pu-238	0.6
Plutonium	Pu-239	0.6
Radium	Ra-226	0.4
Ruthenium	Ru-106	3
Selenium	Se-75	2
Strontium	Sr-90	10
Thallium	Tl-204	200
Thulium	Tm-170	200
Yterbium	Yb-169	3

1.4.3.1.4 For mixtures of radionuclides, determination of whether or not the transport security threshold has been met or exceeded can be calculated by summing the ratios of activity present for each radionuclide divided by the transport security threshold for that radionuclide. If the sum of the fractions is less than 1, then the radioactivity threshold for the mixture has not been met nor exceeded.

This calculation can be made with the formula:

$$\sum_i \frac{A_i}{T_i} < 1$$

Where:

A<sub>i</sub> = activity of radionuclide *i* that is present in a package (TBq)

T<sub>i</sub> = transport security threshold for radionuclide *i* (TBq).

1.4.3.1.5 When radioactive material possess subsidiary risks of other classes or divisions, the criteria of table 1.4.1 should also be taken into account (see also 1.5.5.1).

Part 1 – General provisions, definitions and training

---

## 1.4.3.2 Specific security provisions for high consequence dangerous goods

1.4.3.2.1 The provisions of this section do not apply to ships and to port facilities (see the ISPS Code for ship security plan and for port facility security plan).

## 1.4.3.2.2 Security plans

1.4.3.2.2.1 Consignors and others engaged in the transport of high consequence dangerous goods (see 1.4.3.1) should adopt, implement and comply with a security plan that addresses at least the elements specified in 1.4.3.2.2.2.

1.4.3.2.2.2 The security plan should comprise at least the following elements:

- .1 specific allocation of responsibilities for security to competent and qualified persons with appropriate authority to carry out their responsibilities;
- .2 records of dangerous goods or types of dangerous goods transported;
- .3 review of current operations and assessment of vulnerabilities, including intermodal transfer, temporary transit storage, handling and distribution, as appropriate;
- .4 clear statements of measures, including training, policies (including response to higher threat conditions, new employee/employment verification, etc.), operating practices (e.g. choice/use of routes where known, access to dangerous goods in temporary storage, proximity to vulnerable infrastructure, etc.), equipment and resources that are to be used to reduce security risks;
- .5 effective and up-to-date procedures for reporting and dealing with security threats, breaches of security or security-related incidents;
- .6 procedures for the evaluation and testing of security plans and procedures for periodic review and update of the plans;
- .7 measures to ensure the security of transport information contained in the plan; and
- .8 measures to ensure that the distribution of transport information is limited as far as possible. (Such measures shall not preclude provision of transport documentation required by chapter 5.4 of this Code.)

1.4.3.2.3 For radioactive material, the provisions of this chapter are deemed to be complied with when the provisions of the Convention on Physical Protection of Nuclear Material<sup>\*</sup> and the IAEA circular on The Physical Protection of Nuclear Material<sup>†</sup> and Nuclear Facilities<sup>†</sup> are applied.

<sup>\*</sup> INFCIRC/274/Rev.1, IAEA, Vienna (1980).

<sup>†</sup> INFCIRC/225/Rev.4 (Corrected), IAEA, Vienna (1999).



## Chapter 1.5

### *General provisions concerning class 7*

#### 1.5.1 Scope and application

1.5.1.1 The provisions of this Code establish standards of safety which provide an acceptable level of control of the radiation, criticality and thermal hazards to persons, property and the environment that are associated with the transport of radioactive material. These provisions are based on the IAEA Regulations for the Safe Transport of Radioactive Material (2009 Edition), Safety Standards Series No. TS-R-1, IAEA, Vienna (2009). Explanatory material can be found in "Advisory Material for the IAEA Regulations for the Safe Transport of Radioactive Material" (2005 Edition), Safety Standard Series No. TS-G-1.1 (Rev.1), IAEA, Vienna (2008).

1.5.1.2 The objective of this Code is to establish provisions that shall be satisfied to ensure safety and to protect persons, property and the environment from the effects of radiation in the transport of radioactive material. This protection is achieved by requiring:

- .1 Containment of the radioactive contents;
- .2 Control of external radiation levels;
- .3 Prevention of criticality; and
- .4 Prevention of damage caused by heat.

These provisions are satisfied firstly by applying a graded approach to contents limits for packages and conveyances and to performance standards applied to package designs depending upon the hazard of the radioactive contents. Secondly, they are satisfied by imposing requirements on the design and operation of packages and on the maintenance of packagings, including a consideration of the nature of the radioactive contents. Finally, they are satisfied by requiring administrative controls including, where appropriate, approval by competent authorities.

1.5.1.3 The provisions of this Code apply to the transport of radioactive material by sea, including transport which is incidental to the use of the radioactive material. Transport comprises all operations and conditions associated with and involved in the movement of radioactive material; these include the design, manufacture, maintenance and repair of packaging, and the preparation, consigning, loading, transport including in-transit storage, unloading and receipt at the final destination of loads of radioactive material and packages. A graded approach is applied to the performance standards in the provisions of this Code that are characterized by three general severity levels:

- .1 Routine conditions of transport (incident-free);
- .2 Normal conditions of transport (minor mishaps); and
- .3 Accident conditions of transport.

1.5.1.4 The provisions of this Code shall not apply to:

- .1 Radioactive material that is an integral part of the means of transport;
- .2 Radioactive material moved within an establishment which is subject to appropriate safety regulations in force in the establishment and where the movement does not involve public roads or railways;
- .3 Radioactive material implanted or incorporated into a person or live animal for diagnosis or treatment;
- .4 Radioactive material in consumer products which have received regulatory approval, following their sale to the end user;
- .5 Natural material and ores containing naturally occurring radionuclides which are either in their natural state, or have only been processed for purposes other than for extraction of the radionuclides, and which are not intended to be processed for use of these radionuclides provided the activity concentration of the material does not exceed 10 times the values specified in 2.7.2.2.1.2, or calculated in accordance with 2.7.2.2.2 to 2.7.2.2.6; and
- .6 Non-radioactive solid objects with radioactive substances present on any surfaces in quantities not in excess of the limit set out in the definition for "contamination" in 2.7.1.2.

Part 1 – General provisions, definitions and training

---

1.5.1.5 Specific provisions for the transport of excepted packages

1.5.1.5.1 Excepted packages which may contain radioactive material in limited quantities, instruments, manufactured articles and empty packagings as specified in 2.7.2.4.1 shall be subject only to the following provisions of parts 5 to 7:

- .1 The applicable provisions specified in 5.1.2, 5.1.3.2, 5.1.4, 5.1.5.4, 5.2.1.5.2, 5.2.1.7, 7.1.3.2, 7.6.2.1.8, 7.8.4.2;
- .2 The provisions for excepted packages specified in 6.4.4; and
- .3 If the excepted package contains fissile material, one of the fissile exceptions provided by 2.7.2.3.5 shall apply and the provision of 6.4.7.2 shall be met.

1.5.1.5.2 Excepted packages shall be subject to the relevant provisions of all other parts of this Code.

1.5.2 Radiation protection programme

1.5.2.1 The transport of radioactive material shall be subject to a radiation protection programme which shall consist of systematic arrangements aimed at providing adequate consideration of radiation protection measures.

1.5.2.2 Doses to persons shall be below the relevant dose limits. Protection and safety shall be optimized in order that the magnitude of individual doses, the number of persons exposed, and the likelihood of incurring exposure shall be kept as low as reasonably achievable, economic and social factors being taken into account, within the restrictions that the doses to individuals be subject to dose constraints. A structured and systematic approach shall be adopted and shall include consideration of the interfaces between transport and other activities.

1.5.2.3 The nature and extent of the measures to be employed in the programme shall be related to the magnitude and likelihood of radiation exposures. The programme shall incorporate the provisions in 1.5.2.2, 1.5.2.4 and 7.1.4.5.13 to 7.1.4.5.18. Programme documents shall be available, on request, for inspection by the relevant competent authority.

1.5.2.4 For occupational exposures arising from transport activities, where it is assessed that the effective dose:

- .1 is likely to be between 1 and 6 mSv in a year, a dose assessment programme via workplace monitoring or individual monitoring shall be conducted;
- .2 is likely to exceed 6 mSv in a year, individual monitoring shall be conducted.

When individual monitoring or workplace monitoring is conducted, appropriate records shall be kept.

**Note:** For occupational exposures arising from transport activities, where it is assessed that the effective dose is most unlikely to exceed 1 mSv in a year, no special work patterns, detailed monitoring, dose assessment programmes or individual record keeping need be required.

1.5.3 Quality assurance

1.5.3.1 Quality assurance programmes based on international, national or other standards acceptable to the competent authority shall be established and implemented for the design, manufacture, testing, documentation, use, maintenance and inspection of all special form radioactive material, low dispersible radioactive material and packages and for transport and in-transit storage operations to ensure compliance with the relevant provisions of this Code. Certification that the design specification has been fully implemented shall be available to the competent authority. The manufacturer, consignor or user shall be prepared to provide facilities for competent authority inspection during manufacture and use and to demonstrate to any cognizant competent authority that:

- .1 the manufacturing methods and materials used are in accordance with the approved design specifications; and
- .2 all packagings are periodically inspected and, as necessary, repaired and maintained in good condition so that they continue to comply with all relevant requirements and specifications, even after repeated use.

Where competent authority approval is required, such approval shall take into account and be contingent upon the adequacy of the quality assurance programme.

1.5.4 Special arrangement

1.5.4.1 *Special arrangement* shall mean those provisions, approved by the competent authority, under which consignments which do not satisfy all the provisions of this Code applicable to radioactive material may be transported.

1.5.4.2 Consignments for which conformity with any provision applicable to class 7 is impracticable shall not be transported except under special arrangement. Provided the competent authority is satisfied that conformity with the class 7 provisions of this Code is impracticable and that the requisite standards of safety established by this Code have been demonstrated through alternative means, the competent authority may approve special arrangement transport operations for single or a planned series of multiple consignments. The overall level of safety in transport shall be at least equivalent to that which would be provided if all the applicable provisions had been met. For international consignments of this type, multilateral approval shall be required.

### **1.5.5 Radioactive material possessing other dangerous properties**

1.5.5.1 In addition to the radioactive and fissile properties, any subsidiary risk of the contents of a package, such as explosiveness, flammability, pyrophoricity, chemical toxicity and corrosiveness, shall also be taken into account in the documentation, packing, labelling, marking, placarding, stowage, segregation and transport, in order to be in compliance with all relevant provisions for dangerous goods. (See also special provision 172 and, for excepted packages, special provision 290.)

### **1.5.6 Non-compliance**

1.5.6.1 In the event of a non-compliance with any limit in the provisions of this Code applicable to radiation level or contamination,

- .1 The consignor shall be informed of the non-compliance
  - (i) by the carrier if the non-compliance is identified during transport; or
  - (ii) by the consignee if the non-compliance is identified at receipt;
- .2 The carrier, consignor or consignee, as appropriate, shall:
  - (i) take immediate steps to mitigate the consequences of the non-compliance;
  - (ii) investigate the non-compliance and its causes, circumstances and consequences;
  - (iii) take appropriate action to remedy the causes and circumstances that led to the non-compliance and to prevent a recurrence of similar circumstances that led to the non-compliance; and
  - (iv) communicate to the relevant competent authority(ies) on the causes of the non-compliance and on corrective or preventive actions taken or to be taken; and
- .3 The communication of the non-compliance to the consignor and relevant competent authority(ies), respectively, shall be made as soon as practicable and it shall be immediate whenever an emergency exposure situation has developed or is developing.





**PART 2**  
CLASSIFICATION



## Chapter 2.0

### Introduction

**Note:** For the purposes of this Code, it has been necessary to classify dangerous goods in different classes, to subdivide a number of these classes and to define and describe characteristics and properties of the substances, materials and articles which would fall within each class or division. Moreover, in accordance with the criteria for the selection of marine pollutants for the purposes of Annex III of the International Convention for the Prevention of Pollution from Ships, 1973, as modified by the Protocol of 1978 relating thereto (MARPOL 73/78), a number of dangerous substances in the various classes have also been identified as substances harmful to the marine environment (MARINE POLLUTANTS).

#### 2.0.0 Responsibilities

The classification shall be made by the shipper/consignor or by the appropriate competent authority where specified in this Code.

#### 2.0.1 Classes, divisions, packing groups

##### 2.0.1.1 Definitions

Substances (including mixtures and solutions) and articles subject to the provisions of this Code are assigned to one of the classes 1–9 according to the hazard or the most predominant of the hazards they present. Some of these classes are subdivided into divisions. These classes or divisions are as listed below:

**Class 1: Explosives**

- Division 1.1: substances and articles which have a mass explosion hazard
- Division 1.2: substances and articles which have a projection hazard but not a mass explosion hazard
- Division 1.3: substances and articles which have a fire hazard and either a minor blast hazard or a minor projection hazard or both, but not a mass explosion hazard
- Division 1.4: substances and articles which present no significant hazard
- Division 1.5: very insensitive substances which have a mass explosion hazard
- Division 1.6: extremely insensitive articles which do not have a mass explosion hazard

**Class 2: Gases**

- Class 2.1: flammable gases
- Class 2.2: non-flammable, non-toxic gases
- Class 2.3: toxic gases

**Class 3: Flammable liquids**

**Class 4: Flammable solids; substances liable to spontaneous combustion; substances which, in contact with water, emit flammable gases**

- Class 4.1: flammable solids, self-reactive substances and solid desensitized explosives
- Class 4.2: substances liable to spontaneous combustion
- Class 4.3: substances which, in contact with water, emit flammable gases

**Class 5: Oxidizing substances and organic peroxides**

- Class 5.1: oxidizing substances
- Class 5.2: organic peroxides

**Class 6: Toxic and infectious substances**

- Class 6.1: toxic substances
- Class 6.2: infectious substances

**Class 7: Radioactive material**

**Class 8: Corrosive substances**

**Class 9: Miscellaneous dangerous substances and articles**

The numerical order of the classes and divisions is not that of the degree of danger.

## Part 2 – Classification

**2.0.1.2 Marine pollutants**

2.0.1.2.1 Many of the substances assigned to classes 1 to 9 are deemed as being *marine pollutants* (see chapter 2.10).

2.0.1.2.2 Known marine pollutants are noted in the dangerous goods list and are indicated in the Index.

2.0.1.3 For packing purposes, substances other than those of classes 1, 2, 5.2, 6.2 and 7, and other than self-reactive substances of class 4.1, are assigned to three packing groups in accordance with the degree of danger they present:

Packing group I: substances presenting high danger;

Packing group II: substances presenting medium danger; and

Packing group III: substances presenting low danger.

The packing group to which a substance is assigned is indicated in the Dangerous Goods List in chapter 3.2.

2.0.1.4 Dangerous goods are determined to present one or more of the dangers represented by classes 1 to 9, marine pollutants and, if applicable, the degree of danger (packing group) on the basis of the provisions in chapters 2.1 to 2.10.

2.0.1.5 Dangerous goods presenting a danger of a single class or division are assigned to that class or division and the packing group, if applicable, determined. When an article or substance is specifically listed by name in the Dangerous Goods List in chapter 3.2, its class or division, its subsidiary risk(s) and, when applicable, its packing group are taken from this list.

2.0.1.6 Dangerous goods meeting the defining criteria of more than one hazard class or division and which are not listed by name in the Dangerous Goods List are assigned to a class or division and subsidiary risk(s) on the basis of the precedence of hazard provisions prescribed in 2.0.3.

**2.0.2 UN Numbers and Proper Shipping Names**

2.0.2.1 Dangerous goods are assigned to UN Numbers and Proper Shipping Names according to their hazard classification and their composition.

2.0.2.2 Dangerous goods commonly transported are listed in the Dangerous Goods List in chapter 3.2. Where an article or substance is specifically listed by name, it shall be identified in transport by the Proper Shipping Name in the Dangerous Goods List. Such substances may contain technical impurities (for example those deriving from the production process) or additives for stability or other purposes that do not affect their classification. However, a substance listed by name containing technical impurities or additives for stability or other purposes affecting its classification shall be considered a mixture or solution (see 2.0.2.5). For dangerous goods not specifically listed by name, “generic” or “not otherwise specified” entries are provided (see 2.0.2.7) to identify the article or substance in transport.

Each entry in the Dangerous Goods List is assigned a UN Number. This list also contains relevant information for each entry, such as hazard class, subsidiary risk(s) (if any), packing group (where assigned), packing and tank transport provisions, EmS, segregation and stowage, properties and observations, etc.

Entries in the Dangerous Goods List are of the following four types:

.1 single entries for well-defined substances or articles:

e.g. UN 1090 acetone  
UN 1194 ethyl nitrite solution

.2 generic entries for well-defined groups of substances or articles:

e.g. UN 1133 adhesives  
UN 1266 perfumery product  
UN 2757 carbamate pesticide, solid, toxic  
UN 3101 organic peroxide type B, liquid

.3 specific N.O.S. entries covering a group of substances or articles of a particular chemical or technical nature:

e.g. UN 1477 nitrates, inorganic, N.O.S.  
UN 1987 alcohols, N.O.S.

.4 general N.O.S. entries covering a group of substances or articles meeting the criteria of one or more classes:

e.g. UN 1325 flammable solid, organic, N.O.S.  
UN 1993 flammable liquid, N.O.S.

2.0.2.3 All self-reactive substances of class 4.1 are assigned to one of twenty generic entries in accordance with the classification principles described in 2.4.2.3.3.



- 2.0.2.4 All organic peroxides of class 5.2 are assigned to one of twenty generic entries in accordance with the classification principles described in 2.5.3.3.
- 2.0.2.5 A mixture or solution meeting the classification criteria of this Code composed of a single predominant substance identified by name in the Dangerous Goods List and one or more substances not subject to the provisions of this Code and/or traces of one or more substances identified by name in the Dangerous Goods List, shall be assigned the UN Number and Proper Shipping Name of the predominant substance named in the Dangerous Goods List unless:
- .1 the mixture or solution is identified by name in the Dangerous Goods List;
  - .2 the name and description of the substance named in the Dangerous Goods List specifically indicate that they apply only to the pure substance;
  - .3 the hazard class or division, subsidiary risk(s), packing group, or physical state of the mixture or solution is different from that of the substance named in the Dangerous Goods List; or
  - .4 the hazard characteristics and properties of the mixture or solution necessitate emergency response measures that are different from those required for the substance identified by name in the Dangerous Goods List.
- In those other cases, except the one described in .1, the mixture or solution shall be treated as a dangerous substance not specifically listed by name in the Dangerous Goods List.
- 2.0.2.6 When the class, physical state or packing group has changed in comparison with the pure substance, the solution or mixture shall be shipped in accordance with the provisions for the changed hazard under an appropriate N.O.S. entry.
- 2.0.2.7 Substances or articles which are not specifically listed by name in the Dangerous Goods List shall be classified under a “generic” or “not otherwise specified” (N.O.S.) Proper Shipping Name. The substance or article shall be classified according to the class definitions and test criteria in this part, and the article or substance classified under the generic or “N.O.S.” Proper Shipping Name in the Dangerous Goods List which most appropriately describes the article or substance. This means that a substance is only to be assigned to an entry of type .3 – as defined in 2.0.2.2 – if it cannot be assigned to an entry of type .2, and to an entry of type .4 if it cannot be assigned to an entry of type .2 or .3.\*
- 2.0.2.8 When considering a solution or mixture in accordance with 2.0.2.5, due account shall be given to whether the dangerous constituent comprising the solution or mixture has been identified as a marine pollutant. If this is the case, the provisions of chapter 2.10 are also applicable.
- 2.0.2.9 A mixture or solution, containing one or more substances identified by name in this Code or classified under an N.O.S. or generic entry and one or more substances not subject to the provisions of this Code, is not subject to the provisions of this Code if the hazard characteristics of the mixture or solution are such that they do not meet the criteria (including human experience criteria) for any class.
- 2.0.2.10 A mixture or solution meeting the classification criteria of this Code that is not identified by name in the Dangerous Goods List and that is composed of two or more dangerous goods shall be assigned to an entry that has the Proper Shipping Name, description, hazard class or division, subsidiary risk(s) and packing group that most precisely describe the mixture or solution.

## 2.0.3 Classification of substances, mixtures and solutions with multiple hazards (precedence of hazard characteristics)

- 2.0.3.1 The table of precedence of hazard characteristics in 2.0.3.6 shall be used to determine the class of a substance, mixture or solution having more than one hazard when it is not specifically listed by name in this Code. For substances, mixtures or solutions having multiple hazards which are not specifically listed by name, the most stringent packing group of those assigned to the respective hazards of the goods takes precedence over other packing groups, irrespective of the precedence of hazard table in 2.0.3.6.
- 2.0.3.2 The precedence of hazard table indicates which of the hazards shall be regarded as the primary hazard. The class which appears at the intersection of the horizontal line and the vertical column is the primary hazard and the remaining class is the subsidiary hazard. The packing groups for each of the hazards associated with the substance, mixture or solution shall be determined by reference to the appropriate criteria. The most stringent of the groups so indicated shall then become the packing group of the substance, mixture or solution.
- 2.0.3.3 The Proper Shipping Name (see 3.1.2) of a substance, mixture or solution when classified in accordance with 2.0.3.1 and 2.0.3.2 shall be the most appropriate N.O.S. (“not otherwise specified”) entry in this Code for the class shown as the primary hazard.
- 2.0.3.4 The precedence of hazard characteristics of the following substances, materials and articles have not been dealt with in the precedence of hazard table, as these primary hazards always take precedence:

\* See also the generic or N.O.S. Proper Shipping Name in appendix A.

Part 2 – Classification

- .1 substances and articles of class 1;
- .2 gases of class 2;
- .3 liquid desensitized explosives of class 3;
- .4 self-reactive substances and solid desensitized explosives of class 4.1;
- .5 pyrophoric substances of class 4.2;
- .6 substances of class 5.2;
- .7 substances of class 6.1 with a packing group I vapour inhalation toxicity;
- .8 substances of class 6.2; and
- .9 materials of class 7.

2.0.3.5 Apart from excepted radioactive material (where the other hazardous properties take precedence), radioactive material having other hazardous properties shall always be classified in class 7, with the greatest of the additional hazards being identified. For radioactive material in excepted packages, special provision 290 of chapter 3.3 applies.

2.0.3.6 Precedence of hazards

Class and Packing Group	4.2	4.3	5.1 I	5.1 II	5.1 III	6.1, I Dermal	6.1, I Oral	6.1 II	6.1 III	8, I Liquid	8, I Solid	8, II Liquid	8, II Solid	8, III Liquid	8, III Solid
3 I*		4.3				3	3	3	3	3	–	3	–	3	–
3 II*		4.3				3	3	3	3	8	–	3	–	3	–
3 III*		4.3				6.1	6.1	6.1	3 <sup>†</sup>	8	–	8	–	3	–
4.1 II*	4.2	4.3	5.1	4.1	4.1	6.1	6.1	4.1	4.1	–	8	–	4.1	–	4.1
4.1 III*	4.2	4.3	5.1	4.1	4.1	6.1	6.1	6.1	4.1	–	8	–	8	–	4.1
4.2 II		4.3	5.1	4.2	4.2	6.1	6.1	4.2	4.2	8	8	4.2	4.2	4.2	4.2
4.2 III		4.3	5.1	5.1	4.2	6.1	6.1	6.1	4.2	8	8	8	8	4.2	4.2
4.3 I			5.1	4.3	4.3	6.1	4.3	4.3	4.3	4.3	4.3	4.3	4.3	4.3	4.3
4.3 II			5.1	4.3	4.3	6.1	4.3	4.3	4.3	8	8	4.3	4.3	4.3	4.3
4.3 III			5.1	5.1	4.3	6.1	6.1	6.1	4.3	8	8	8	8	4.3	4.3
5.1 I						5.1	5.1	5.1	5.1	5.1	5.1	5.1	5.1	5.1	5.1
5.1 II						6.1	5.1	5.1	5.1	8	8	5.1	5.1	5.1	5.1
5.1 III						6.1	6.1	6.1	5.1	8	8	8	8	5.1	5.1
6.1 I, Dermal										8	6.1	6.1	6.1	6.1	6.1
6.1 I, Oral										8	6.1	6.1	6.1	6.1	6.1
6.1 II, Inhalation										8	6.1	6.1	6.1	6.1	6.1
6.1 II, Dermal										8	6.1	8	6.1	6.1	6.1
6.1 II, Oral										8	8	8	6.1	6.1	6.1
6.1 III										8	8	8	8	8	8

\* Substances of class 4.1 other than self-reactive substances and solid desensitized explosives and substances of class 3 other than liquid desensitized explosives.

<sup>†</sup> 6.1 for pesticides.

– Denotes an impossible combination.

For hazards not shown in this table, see 2.0.3.

2.0.4 Transport of samples

2.0.4.1 When the hazard class of a substance is uncertain and it is being transported for further testing, a tentative hazard class, Proper Shipping Name and identification number shall be assigned on the basis of the consignor’s knowledge of the substances and application of:

- .1 the classification criteria of this Code; and
- .2 the precedence of hazards given in 2.0.3.

The most severe packing group possible for the Proper Shipping Name chosen shall be used.

Where this provision is used, the Proper Shipping Name shall be supplemented with the word "SAMPLE" (such as FLAMMABLE LIQUID, N.O.S., SAMPLE). In certain instances, where a specific Proper Shipping Name is provided for a sample of a substance considered to meet certain classification criteria (such as UN 3167, GAS SAMPLE, NON-PRESSURIZED, FLAMMABLE), that Proper Shipping Name shall be used. When an N.O.S. entry is used to transport the sample, the Proper Shipping Name need not be supplemented with the technical name as required by special provision 274.

**2.0.4.2** Samples of the substance shall be transported in accordance with the provisions applicable to the tentative assigned Proper Shipping Name provided:

- .1 the substance is not considered to be a substance prohibited for transport by 1.1.3;
- .2 the substance is not considered to meet the criteria for class 1 or considered to be an infectious substance or a radioactive material;
- .3 the substance is in compliance with 2.4.2.3.2.4.2 or 2.5.3.2.5.1 if it is a self-reactive substance or an organic peroxide, respectively;
- .4 the sample is transported in a combination packaging with a net mass per package not exceeding 2.5 kg; and
- .5 the sample is not packed together with other goods.

## **2.0.5 Transport of wastes**

### **2.0.5.1 Preamble**

Wastes, which are dangerous goods, shall be transported in accordance with the relevant international recommendations and conventions and, in particular, where it concerns transport by sea, with the provisions of this Code.

### **2.0.5.2 Applicability**

**2.0.5.2.1** The provisions of this chapter are applicable to the transport of wastes by ships and shall be considered in conjunction with all other provisions of this Code.

**2.0.5.2.2** Substances, solutions, mixtures or articles containing or contaminated with radioactive material are subject to the applicable provisions for radioactive material in class 7, and are not to be considered as wastes for the purposes of this chapter.

### **2.0.5.3 Transboundary movements under the Basel Convention\***

**2.0.5.3.1** Transboundary movement of wastes is permitted to commence only when:

- .1 notification has been sent by the competent authority of the country of origin, or by the generator or exporter through the channel of the competent authority of the country of origin, to the country of final destination; and
- .2 the competent authority of the country of origin, having received the written consent of the country of final destination stating that the wastes will be safely incinerated or treated by other methods of disposal, has given authorization to the movement.

**2.0.5.3.2** In addition to the transport document required in chapter 5.4, all transboundary movements of wastes shall be accompanied by a waste movement document from the point at which a transboundary movement commences to the point of disposal. This document shall be available at all times to the competent authorities and to all persons involved in the management of waste transport operations.

**2.0.5.3.3** The transport of solid wastes in bulk in cargo transport units and road vehicles is only permitted with the approval of the competent authority of the country of origin.

**2.0.5.3.4** In the event that packages and cargo transport units containing wastes are suffering from leakage or spillage, the competent authorities of the countries of origin and destination shall be immediately informed and advice on the action to be taken obtained from them.

\* Basel Convention on the Control of Transboundary Movements of Hazardous Wastes and their Disposal (1989)

## Part 2 – Classification

## 2.0.5.4 Classification of wastes

- 2.0.5.4.1 A waste containing only one constituent which is a dangerous substance subject to the provisions of this Code shall be regarded as being that particular substance. If the concentration of the constituent is such that the waste continues to present a hazard inherent in the constituent itself, it shall be classified according to the criteria of the applicable classes.
- 2.0.5.4.2 A waste containing two or more constituents which are dangerous substances subject to the provisions of this Code shall be classified under the applicable class in accordance with their dangerous characteristics and properties as described in 2.0.5.4.3 and 2.0.5.4.4.
- 2.0.5.4.3 The classification according to the dangerous characteristics and properties shall be carried out as follows:
- .1 determination of the physical and chemical characteristics and physiological properties by measurement or calculation followed by classification according to the criteria of the applicable class(es); or
  - .2 if the determination is not practicable, the waste shall be classified according to the constituent presenting the predominant hazard.
- 2.0.5.4.4 In determining the predominant hazard, the following criteria shall be taken into account:
- .1 if one or more constituents fall within a certain class and the waste presents a hazard inherent in these constituents, the waste shall be included in that class; or
  - .2 if there are constituents falling under two or more classes, the classification of the waste shall take into account the order of precedence applicable to dangerous substances with multiple hazards set out in 2.0.3.
- 2.0.5.4.5 Wastes harmful to the marine environment only shall be transported under the class 9 entries for ENVIRONMENTALLY HAZARDOUS SUBSTANCE, LIQUID, N.O.S., UN 3082, or ENVIRONMENTALLY HAZARDOUS SUBSTANCE, SOLID, N.O.S., UN 3077, with the addition of the word "WASTE". However, this is not applicable to substances which are covered by individual entries in this Code.
- 2.0.5.4.6 Wastes not otherwise subject to the provisions of this Code but covered under the Basel Convention may be transported under the class 9 entries for ENVIRONMENTALLY HAZARDOUS SUBSTANCE, LIQUID, N.O.S., UN 3082 or ENVIRONMENTALLY HAZARDOUS SUBSTANCE, SOLID, N.O.S., UN 3077.

## Chapter 2.1

### *Class 1 – Explosives*

#### 2.1.0 **Introductory notes** (these notes are not mandatory)

- Note 1:** Class 1 is a restricted class, that is, only those explosive substances and articles that are listed in the Dangerous Goods List in chapter 3.2 may be accepted for transport. However, the competent authorities retain the right by mutual agreement to approve transport of explosive substances and articles for special purposes under special conditions. Therefore entries have been included in the Dangerous Goods List for “Substances, explosive, not otherwise specified” and “Articles, explosive, not otherwise specified”. It is intended that these entries should only be used when no other method of operation is possible.
- Note 2:** General entries such as “Explosive, blasting, type A” are used to allow for the transport of new substances. In preparing these provisions, military ammunition and explosives have been taken into consideration to the extent that they are likely to be transported by commercial carriers.
- Note 3:** A number of substances and articles in class 1 are described in appendix B. These descriptions are given because a term may not be well-known or may be at variance with its usage for regulatory purposes.
- Note 4:** Class 1 is unique in that the type of packaging frequently has a decisive effect on the hazard and therefore on the assignment to a particular division. The correct division is determined by use of the procedures provided in this chapter.

#### 2.1.1 **Definitions and general provisions**

##### 2.1.1.1 Class 1 comprises:

- .1 explosive substances (a substance which is not itself an explosive but which can form an explosive atmosphere of gas, vapour or dust is not included in class 1), except those which are too dangerous to transport or those where the predominant hazard is one appropriate to another class;
- .2 explosive articles, except devices containing explosive substances in such quantity or of such a character that their inadvertent or accidental ignition or initiation during transport shall not cause any effect external to the device either by projection, fire, smoke, heat or loud noise (see 2.1.3.4); and
- .3 substances and articles not mentioned under .1 and .2 which are manufactured with a view to producing a practical, explosive or pyrotechnic effect.

2.1.1.2 Transport of explosive substances which are unduly sensitive, or so reactive as to be subject to spontaneous reaction, is prohibited.

##### 2.1.1.3 **Definitions**

For the purposes of this Code, the following definitions apply:

- .1 *Explosive substance* means a solid or liquid substance (or a mixture of substances) which is in itself capable by chemical reaction of producing gas at such a temperature and pressure and at such a speed as to cause damage to the surroundings. Pyrotechnic substances are included even when they do not evolve gases.
- .2 *Pyrotechnic substance* means a substance or a mixture of substances designed to produce an effect by heat, light, sound, gas or smoke or a combination of these as the result of non-detonative self-sustaining exothermic chemical reactions.
- .3 *Explosive article* means an article containing one or more explosive substances.
- .4 *Mass explosion* means one which affects almost the entire load virtually instantaneously.
- .5 *Phlegmatized* means that a substance (or “phlegmatizer”) has been added to an explosive to enhance its safety in handling and transport. The phlegmatizer renders the explosive insensitive, or less sensitive, to the following actions: heat, shock, impact, percussion or friction. Typical phlegmatizing agents include, but are not limited to: wax, paper, water, polymers (such as chlorofluoropolymers), alcohol and oils (such as petroleum jelly and paraffin).

Part 2 – Classification

---

2.1.1.4 Hazard divisions

The six hazard divisions of class 1 are:

Division 1.1 Substances and articles which have a mass explosion hazard

Division 1.2 Substances and articles which have a projection hazard but not a mass explosion hazard

Division 1.3 Substances and articles which have a fire hazard and either a minor blast hazard or a minor projection hazard or both, but not a mass explosion hazard

This division comprises substances and articles:

.1 which give rise to considerable radiant heat; or

.2 which burn one after another, producing minor blast or projection effects or both.

Division 1.4 Substances and articles which present no significant hazard

This division comprises substances and articles which present only a small hazard in the event of ignition or initiation during transport. The effects are largely confined to the package and no projection of fragments of appreciable size or range is to be expected. An external fire must not cause virtually instantaneous explosion of almost the entire contents of the package.

**Note:** Substances and articles in this division are in compatibility group S if they are so packaged or designed that any hazardous effects arising from the accidental functioning are confined within the package unless the package has been degraded by fire, in which case all blast or projection effects are limited to the extent that they do not significantly hinder fire fighting or other emergency response efforts in the immediate vicinity of the package.

Division 1.5 Very insensitive substances which have a mass explosion hazard

This division comprises substances which have a mass explosion hazard but are so insensitive that there is very little probability of initiation or of transition from burning to detonation under normal conditions of transport.

**Note:** The probability of transition from burning to detonation is greater when large quantities are transported in a ship. As a consequence, the stowage provisions for explosive substances in division 1.1 and for those in division 1.5 are identical.

Division 1.6 Extremely insensitive articles which do not have a mass explosion hazard

This division comprises articles which contain only extremely insensitive substances and which demonstrate a negligible probability of accidental initiation or propagation.

**Note:** The risk from articles of division 1.6 is limited to the explosion of a single article.

2.1.1.5 Any substance or article having or suspected of having explosive characteristics shall first be considered for classification in class 1 in accordance with the procedures in 2.1.3. Goods are not classified in class 1 when:

- .1 unless specially authorized, the transport of an explosive substance is prohibited because sensitivity of the substance is excessive;
- .2 the substance or article comes within the scope of those explosive substances and articles which are specifically excluded from class 1 by the definition of this class; or
- .3 the substance or article has no explosive properties.

2.1.2 Compatibility groups and classification codes

2.1.2.1 Goods of class 1 are considered to be “compatible” if they can be safely stowed or transported together without significantly increasing either the probability of an accident or, for a given quantity, the magnitude of the effects of such an accident. By this criterion, goods listed in this class have been divided into a number of compatibility groups, each denoted by a letter from A to L (excluding I), N and S. These are described in 2.1.2.2 and 2.1.2.3.

2.1.2.2 Compatibility groups and classification codes

Description of substance or articles to be classified	Compatibility group	Classification code
Primary explosive substance	A	1.1A
Article containing a primary explosive substance and not containing two or more effective protective features. Some articles, such as detonators for blasting, detonator assemblies for blasting and primers, cap-type, are included even though they do not contain primary explosives	B	1.1B 1.2B 1.4B
Propellant explosive substance or other deflagrating explosive substance or article containing such explosive substance	C	1.1C 1.2C 1.3C 1.4C
Secondary detonating explosive substance or black powder or article containing a secondary detonating explosive substance, in each case without means of initiation and without a propelling charge, or article containing a primary explosive substance and containing two or more effective protective features	D	1.1D 1.2D 1.4D 1.5D
Article containing a secondary detonating explosive substance, without means of initiation, with a propelling charge (other than one containing a flammable liquid or gel or hypergolic liquids)	E	1.1E 1.2E 1.4E
Article containing a secondary detonating explosive substance with its own means of initiation, with a propelling charge (other than one containing a flammable liquid or gel or hypergolic liquids) or without a propelling charge	F	1.1F 1.2F 1.3F 1.4F
Pyrotechnic substance, or article containing a pyrotechnic substance, or article containing both an explosive substance and an illuminating, incendiary, tear- or smoke-producing substance (other than a water-activated article or one containing white phosphorus, phosphides, a pyrophoric substance, a flammable liquid or gel, or hypergolic liquids)	G	1.1G 1.2G 1.3G 1.4G
Article containing both an explosive substance and white phosphorus	H	1.2H 1.3H
Article containing both an explosive substance and a flammable liquid or gel	J	1.1J 1.2J 1.3J
Article containing both an explosive substance and a toxic chemical agent	K	1.2K 1.3K
Explosive substance or article containing an explosive substance and presenting a special risk (such as due to water-activation or presence of hypergolic liquids, phosphides or a pyrophoric substance) and needing isolation of each type (see 7.2.7.1.4, Note 2)	L	1.1L 1.2L 1.3L
Articles containing only extremely insensitive substances	N	1.6N
Substance or article so packaged or designed that any hazardous effects arising from accidental functioning are confined within the package unless the package has been degraded by fire, in which case all blast or projection effects are limited to the extent that they do not significantly hinder or prohibit fire fighting or other emergency response efforts in the immediate vicinity of the package	S	1.4S

**Note 1:** Articles of compatibility groups D and E may be fitted or packed together with their own means of initiation provided that such means have at least two effective protective features designed to prevent an explosion in the event of accidental functioning of the means of initiation. Such articles and packages shall be assigned to compatibility groups D or E.

**Note 2:** Articles of compatibility groups D and E may be packed together with their own means of initiation, which do not have two effective protective features when, in the opinion of the competent authority of the country of origin, the accidental functioning of the means of initiation does not cause the explosion of an article under normal conditions of transport. Such packages shall be assigned to compatibility groups D or E.

Part 2 – Classification

2.1.2.3 Scheme of classification of explosives, combination of hazard division with compatibility group

Hazard division	Compatibility group													Σ A-S
	A	B	C	D	E	F	G	H	J	K	L	N	S	
1.1	1.1A	1.1B	1.1C	1.1D	1.1E	1.1F	1.1G		1.1J		1.1L			9
1.2		1.2B	1.2C	1.2D	1.2E	1.2F	1.2G	1.2H	1.2J	1.2K	1.2L			10
1.3			1.3C			1.3F	1.3G	1.3H	1.3J	1.3K	1.3L			7
1.4		1.4B	1.4C	1.4D	1.4E	1.4F	1.4G						1.4S	7
1.5				1.5D										1
1.6												1.6N		1
Σ 1.1-1.6	1	3	4	4	3	4	4	2	3	2	3	1	1	35

2.1.2.4 The definitions of compatibility groups in 2.1.2.2 are intended to be mutually exclusive, except for a substance or article which qualifies for compatibility group S. Since the criterion of compatibility group S is an empirical one, assignment to this group is necessarily linked to the tests for assignment to division 1.4.

2.1.3 Classification procedure

2.1.3.1 Any substance or article having or suspected of having explosive characteristics shall be considered for classification in class 1. Substances and articles classified in class 1 shall be assigned to the appropriate division and compatibility group. Goods of class 1 shall be classified in accordance with the latest version of the United Nations *Manual of Tests and Criteria*.

2.1.3.2 Prior to transport, the classification of all explosive substances and articles, together with the compatibility group assignment and the Proper Shipping Name under which the substance or article is to be transported, shall have been approved by the competent authority of the country of manufacture. A new approval would be required for:

- .1 a new explosive substance; or
- .2 a new combination or mixture of explosive substances which is significantly different from other combinations or mixtures previously manufactured and approved; or
- .3 a new design of an explosive article, an article containing a new explosive substance, or an article containing a new combination or mixture of explosive substances; or
- .4 an explosive substance or article with a new design or type of packaging, including a new type of inner packaging.

2.1.3.3 Assessment of the hazard division is usually made on the basis of test results. A substance or article shall be assigned to the hazard division which corresponds to the results of the tests to which the substance or article, as offered for transport, has been subjected. Other test results, and data assembled from accidents which have occurred, may also be taken into account.

2.1.3.4 Exclusion from Class 1

2.1.3.4.1 The competent authority may exclude an article or substance from class 1 by virtue of test results and the Class 1 definition.

2.1.3.4.2 An article may be excluded from Class 1 by the competent authority when three unpackaged articles, each individually activated by its own means of initiation or ignition or external means to function in the designed mode, meet the following test criteria:

- .1 No external surface shall have a temperature of more than 65°C. A momentary spike in temperature up to 200°C is acceptable;
- .2 No rupture or fragmentation of the external casing or movement of the article or detached parts thereof of more than one metre in any direction;

**Note:** Where the integrity of the article may be affected in the event of an external fire these criteria shall be examined by a fire test, such as described in ISO 12097-3.

- .3 No audible report exceeding 135 dB(C) peak at a distance of one metre;
- .4 No flash or flame capable of igniting a material such as a sheet of 80 ± 10 g/m<sup>2</sup> paper in contact with the article; and
- .5 No production of smoke, fumes or dust in such quantities that the visibility in a one cubic metre chamber equipped with appropriately sized blow out panels is reduced more than 50% as measured by a calibrated light (lux) meter or radiometer located one metre from a constant light source located at the midpoint on opposite walls. The general guidance on Optical Density Testing in ISO 5659-1 and the



general guidance on the Photometric System described in Section 7.5 in ISO 5659-2 may be used or similar optical density measurement methods designed to accomplish the same purpose may also be employed. A suitable hood cover surrounding the back and sides of the light meter shall be used to minimize effects of scattered or leaking light not emitted directly from the source.

**Note 1:** If during the tests addressing criteria .1, .2, .3 and .4 no or very little smoke is observed the test described in .5 may be waived.

**Note 2:** The competent authority may require testing in packaged form if it is determined that, as packaged for transport, the article may pose a greater risk."

**2.1.3.5 Assignment of fireworks to hazard divisions**

**2.1.3.5.1** Fireworks shall normally be assigned to hazard divisions 1.1, 1.2, 1.3, and 1.4 on the basis of test data derived from Test Series 6 of the United Nations *Manual of Tests and Criteria*. However, since the range of such articles is very extensive and the availability of test facilities may be limited, assignment to hazard divisions may also be made in accordance with the procedure in 2.1.3.5.2.

**2.1.3.5.2** Assignment of fireworks to UN Nos. 0333, 0334, 0335 or 0336 may be made on the basis of analogy, without the need for Test Series 6 testing, in accordance with the default fireworks classification table in 2.1.3.5.5. Such assignment shall be made with the agreement of the competent authority. Items not specified in the table shall be classified on the basis of test data derived from Test Series 6 of the United Nations *Manual of Tests and Criteria*.

**Note:** The addition of other types of fireworks to column 1 of the table in 2.1.3.5.5 shall only be made on the basis of full test data submitted to the UN Sub-Committee of Experts on the Transport of Dangerous Goods for consideration.

**2.1.3.5.3** Where fireworks of more than one hazard division are packed in the same package they shall be classified on the basis of the highest hazard division unless test data derived from Test Series 6 of the United Nations *Manual of Tests and Criteria* indicate otherwise.

**2.1.3.5.4** The classification shown in the table in 2.1.3.5.5 applies only for articles packed in fibreboard boxes (4G).

Part 2 – Classification

2.1.3.5.5 Default fireworks classification table<sup>8</sup>

Note 1: References to percentages in the table, unless otherwise stated, are to the mass of all pyrotechnic substances (e.g., rocket motors, lifting charge, bursting charge and effect charge).

Note 2: "Flash composition" in this table refers to pyrotechnic substances in powder form or as pyrotechnic units as presented in the fireworks, that are used to produce an aural effect, or used as a bursting charge or lifting charge, unless the time taken for the pressure rise is demonstrated to be more than 8 ms for 0.5 g of pyrotechnic substance in the HSL Flash Composition Test in Appendix 7 of the United Nations *Manual of Tests and Criteria*.

Note 3: Dimensions in mm refers to:

- for spherical and peanut shells, the diameter of the sphere of the shell;
- for cylindrical shells, the length of the shell;
- for a shell in mortar, Roman candle, shot tube firework or mine, the inside diameter of the tube comprising or containing the firework;
- for a bag mine or cylinder mine, the inside diameter of the mortar intended to contain the mine.

<sup>8</sup>This table contains a list of firework classifications that may be used in the absence of Test Series 6, of the United Nations *Manual of Tests and Criteria*, data (see 2.1.3.5.2).

Type	Includes: / Synonym:	Definition	Specification	Classification
Shell, spherical or cylindrical	Spherical display shell: aerial shell, colour shell, dye shell, multi-break shell, multi-effect shell, nautical shell, parachute shell, smoke shell, star shell; report shell: maroon, salute, sound shell, thunderclap, aerial shell kit	Device with or without propellant charge, with delay fuse and bursting charge, pyrotechnic unit(s) or loose pyrotechnic substance and designed to be projected from a mortar	All report shells Colour shell: ≥ 180 mm Colour shell: < 180 mm with > 25% flash composition, as loose powder and/or report effects Colour shell: < 180 mm with ≤ 25% flash composition, as loose powder and/or report effects	1.1G 1.1G 1.1G
	Peanut shell	Device with two or more spherical aerial shells in a common wrapper propelled by the same propellant charge with separate external delay fuses	Colour shell: ≤ 50 mm, or ≤ 60 g pyrotechnic substance, with ≤ 2% flash composition as loose powder and/or report effects The most hazardous spherical aerial shell determines the classification	1.3G 1.4G
Preloaded mortar, shell in mortar	Assembly comprising a spherical or cylindrical shell inside a mortar from which the shell is designed to be projected		All report shells Colour shell: ≥ 180 mm Colour shell: > 25% flash composition as loose powder and/or report effects Colour shell: > 50 mm and < 180 mm Colour shell: ≤ 50 mm, or < 60 g pyrotechnic substance, with ≤ 25% flash composition as loose powder and/or report effects	1.1G 1.1G 1.2G 1.3G

Type	Includes: / Synonym:	Definition	Specification	Classification
	Shell of shells (spherical) (Reference to percentages for shell of shells are to the gross mass of the fireworks article)	Device without propellant charge, with delay fuse and bursting charge, containing report shells and inert materials and designed to be projected from a mortar	> 120 mm	1.1G
		Device without propellant charge, with delay fuse and bursting charge, containing report shells $\leq$ 25 g flash composition per report unit, with $\leq$ 33% flash composition and $\geq$ 60% inert materials and designed to be projected from a mortar	$\leq$ 120 mm	1.3G
		Device without propellant charge, with delay fuse and bursting charge, containing colour shells and/or pyrotechnic units and designed to be projected from a mortar	> 300 mm	1.1G
		Device without propellant charge, with delay fuse and bursting charge, containing colour shells $\leq$ 70 mm and/or pyrotechnic units, with $\leq$ 25% flash composition and $\leq$ 60% pyrotechnic substance and designed to be projected from a mortar	> 200 mm and $\leq$ 300 mm	1.3G
		Device with propellant charge, with delay fuse and bursting charge, containing colour shells $\leq$ 70 mm and/or pyrotechnic units, with $\leq$ 25% flash composition and $\leq$ 60% pyrotechnic substance and designed to be projected from a mortar	$\leq$ 200 mm	1.3G
Battery/ combination	Barrage, bombardos, cakes, finale box, flowerbed, hybrid, multiple tubes, shell cakes, banger batteries, flash banger batteries	Assembly including several elements either containing the same type or several types each corresponding to one of the types of fireworks listed in this table, with one or two points of ignition	The most hazardous firework type determines the classification	
Roman candle	Exhibition candle, candle, bombettes	Tube containing a series of pyrotechnic units consisting of alternate pyrotechnic substance, propellant charge, and transmitting fuse	$\geq$ 50 mm inner diameter, containing flash composition, or $<$ 50 mm with $>$ 25% flash composition	1.1G
			$>$ 50 mm inner diameter, containing no flash composition	1.2G
			$<$ 50 mm inner diameter and $\leq$ 25% flash composition	1.3G
			$\leq$ 30 mm inner diameter, each pyrotechnic unit $\leq$ 25 g and $\leq$ 5% flash composition	1.4G
Shot tube	Single shot Roman candle, small preloaded mortar	Tube containing a pyrotechnic unit consisting of pyrotechnic substance, propellant charge with or without transmitting fuse	$\leq$ 30 mm inner diameter and pyrotechnic unit $>$ 25 g, or $>$ 5% and $\leq$ 25% flash composition	1.3G
			$\leq$ 30 mm inner diameter, pyrotechnic unit $\leq$ 25 g and $\leq$ 5% flash composition	1.4G

Part 2 – Classification

Type	Includes: / Synonym:	Definition	Specification	Classification
Rocket	Avalanche rocket, signal rocket, whistling rocket, bottle rocket, sky rocket, missile type rocket, table rocket	Tube containing pyrotechnic substance and/or pyrotechnic units, equipped with stick(s) or other means for stabilization of flight, and designed to be propelled into the air	Flash composition effects only Flash composition > 25% of the pyrotechnic substance > 20 g pyrotechnic substance and flash composition ≤ 25 % ≤ 20 g pyrotechnic substance, black powder bursting charge and ≤ 0.13 g flash composition per report and ≤ 1 g in total	1.1G 1.1G 1.3G 1.4G
Mine	Pot-a-feu, ground mine, bag mine, cylinder mine	Tube containing propellant charge and pyrotechnic units and designed to be placed on the ground or to be fixed in the ground. The principal effect is ejection of all the pyrotechnic units in a single burst producing a widely dispersed visual and/or aural effect in the air or: Cloth or paper bag or cloth or paper cylinder containing propellant charge and pyrotechnic units, designed to be placed in a mortar and to function as a mine	> 25% flash composition, as loose powder and/or report effects ≥ 180 mm and ≤ 25% flash composition, as loose powder and/or report effects < 180 mm and ≤ 25% flash composition, as loose powder and/or report effects ≤ 150 g pyrotechnic substance, containing ≤ 5% flash composition as loose powder and/or report effects. Each pyrotechnic unit ≤ 25 g, each report effect < 2 g; each whistle, if any, ≤ 3 g	1.1G 1.1G 1.3G 1.4G
Fountain	Volcanos, gerbs, showers, lances, Bengal fire, fitter sparkler, cylindrical fountains, cone fountains, illuminating torch	Non-metallic case containing pressed or consolidated pyrotechnic substance producing sparks and flame	≥ 1 kg pyrotechnic substance < 1 kg pyrotechnic substance	1.3G 1.4G
Sparkler	Handheld sparklers, non-handheld sparklers, wire sparklers	Rigid wire partially coated (along one end) with slow-burning pyrotechnic substance with or without an ignition tip	Perchlorate based sparklers: > 5 g per item or > 10 items per pack Perchlorate based sparklers: ≤ 5 g per item and ≤ 10 items per pack Nitrate based sparklers: ≤ 30 g per item	1.3G 1.4G
Bengal stick	Dipped stick	Non-metallic stick partially coated (along one end) with slow-burning pyrotechnic substance and designed to be held in the hand	Perchlorate based items: > 5 g per item or > 10 items per pack Perchlorate based items: ≤ 5 g per item and ≤ 10 items per pack; nitrate based items: ≤ 30 g per item	1.3G 1.4G

Type	Includes: / Synonym:	Definition	Specification	Classification
Low hazard fireworks and novelties	Table bombs, throwdowns, crackling granules, smokes, fog, snakes, glow worm, serpents, snaps, party poppers	Device designed to produce very limited visible and/or audible effect which contains small amounts of pyrotechnic and/or explosive substance	Throwdowns and snaps may contain up to 1.6 mg of silver fulminate, snaps and party poppers may contain up to 16 mg of potassium chlorate/red phosphorus mixture; other articles may contain up to 5 g or pyrotechnic substance, but no flash composition	1.4G
Spinner	Aerial spinner, helicopter, chaser, ground spinner	Non-metallic tube or tubes containing gas- or spark-producing pyrotechnic substance, with or without noise-producing substance, with or without aerofolds attached	Pyrotechnic substance per item > 20 g, containing ≤ 3% flash composition as report effects, or whistle composition ≤ 5 g	1.3G
Wheels	Catherine wheels, Saxon	Assembly including drivers containing pyrotechnic substance and provided with a means of attaching it to a support so that it can rotate	Pyrotechnic substance per item: ≤ 20 g, containing ≤ 3% flash composition as report effects, or whistle composition ≤ 5 g	1.4G
Aerial wheel	Flying Saxon, UFOs, rising crown	Tubes containing propellant charges and sparks-, flame- and/or noise-producing pyrotechnic substances, the tubes being fixed to a supporting ring	≥ 1 kg total pyrotechnic substance, no report effect, each whistle (if any) ≤ 25 g and ≤ 50 g whistle composition per wheel  < 1 kg total pyrotechnic substance, no report effect, each whistle (if any) ≤ 5 g and ≤ 10 g whistle composition per wheel	1.3G  1.4G
Selection pack	Display selection box, display selection pack, garden selection box, indoor selection box; assortment	A pack of more than one type each corresponding to one of the types of fireworks listed in this table	> 200 g total pyrotechnic substance or > 60 g pyrotechnic substance per driver, ≤ 3% flash composition as report effects, each whistle (if any) ≤ 25 g and ≤ 50 g whistle composition per wheel  ≤ 200 g total pyrotechnic substance and ≤ 60 g pyrotechnic substance per driver, ≤ 3% flash composition as report effects, each whistle (if any) ≤ 5 g and ≤ 10 g whistle composition per wheel	1.3G  1.4G
Firecracker	Celebration cracker, celebration roll, string cracker	Assembly of tubes (paper or cardboard) linked by a pyrotechnic fuse, each tube intended to produce an aural effect	The most hazardous firework type determines the classification	1.4G
Banger	Salute, flash banger, lady cracker	Non-metallic tube containing report composition intended to produce an aural effect	Each tube ≤ 140 mg of flash composition or ≤ 1 g black powder  > 2 g flash composition per item ≤ 2 g flash composition per item and ≤ 10 g per inner packaging ≤ 1 g flash composition per item and ≤ 10 g per inner packaging or ≤ 10 g black powder per item	1.1G 1.3G 1.4G

## Chapter 2.2

---

### Class 2 – Gases

#### 2.2.0 Introductory note

“Toxic” has the same meaning as “poisonous”.

#### 2.2.1 Definitions and general provisions

2.2.1.1 A gas is a substance which:

- .1 at 50°C has a vapour pressure greater than 300 kPa; or
- .2 is completely gaseous at 20°C at a standard pressure of 101.3 kPa.

2.2.1.2 The transport condition of a gas is described according to its physical state as:

- .1 *Compressed gas*: a gas which when packaged under pressure for transport is entirely gaseous at –50°C; this category includes all gases with a critical temperature less than or equal to –50°C;
- .2 *Liquefied gas*: a gas which when packaged under pressure for transport is partially liquid at temperatures above –50 °C. A distinction is made between:
  - high pressure liquefied gas*: a gas with a critical temperature between –50°C and +65°C, and
  - low pressure liquefied gas*: a gas with a critical temperature above +65°C;
- .3 *Refrigerated liquefied gas*: a gas which when packaged for transport is made partially liquid because of its low temperature; or
- .4 *Dissolved gas*: a gas which when packaged under pressure for transport is dissolved in a liquid phase solvent.

2.2.1.3 The class comprises compressed gases, liquefied gases, dissolved gases, refrigerated liquefied gases, mixtures of one or more gases with one or more vapours of substances of other classes, articles charged with a gas and aerosols.

2.2.1.4 Gases are normally transported under pressure varying from high pressure in the case of compressed gases to low pressure in the case of refrigerated gases.

2.2.1.5 According to their chemical properties or physiological effects, which may vary widely, gases may be: flammable; non-flammable; non-toxic; toxic; supporters of combustion; corrosive; or may possess two or more of these properties simultaneously.

2.2.1.5.1 Some gases are chemically and physiologically inert. Such gases as well as other gases, normally accepted as non-toxic, will nevertheless be suffocating in high concentrations.

2.2.1.5.2 Many gases of this class have narcotic effects which may occur at comparatively low concentrations or may evolve highly toxic gases when involved in a fire.

2.2.1.5.3 All gases which are heavier than air will present a potential danger if allowed to accumulate in the bottom of cargo spaces.

#### 2.2.2 Class subdivisions

Class 2 is subdivided further according to the primary hazard of the gas during transport:

**Note:** For UN 1950 AEROSOLS, see also the criteria in special provision 63 and for UN 2037 RECEPTACLES, SMALL, CONTAINING GAS (GAS CARTRIDGES) see also special provision 303.

##### 2.2.2.1 Class 2.1 Flammable gases

Gases which at 20°C and a standard pressure of 101.3 kPa:

- .1 are ignitable when in a mixture of 13% or less by volume with air; or

- .2 have a flammable range with air of at least 12 percentage points regardless of the lower flammable limit. Flammability shall be determined by tests or calculation in accordance with methods adopted by the International Organization for Standardization (see ISO 10156:2010). Where insufficient data are available to use these methods, tests by a comparable method recognized by a national competent authority may be used.

#### 2.2.2.2 Class 2.2 Non-flammable, non-toxic gases

Gases which:

- .1 are asphyxiant – gases which dilute or replace the oxygen normally in the atmosphere; or
- .2 are oxidizing – gases which may, generally by providing oxygen, cause or contribute to the combustion of other material more than air does; or
- .3 do not come under the other classes.

**Note:** In 2.2.2.2.2, “gases which cause or contribute to the combustion of other material more than air does” means pure gases or gas mixtures with an oxidizing power greater than 23.5% as determined by a method specified in ISO 10156:2010.

#### 2.2.2.3 Class 2.3 Toxic gases

Gases which:

- .1 are known to be so toxic or corrosive to humans as to pose a hazard to health; or
- .2 are presumed to be toxic or corrosive to humans because they have a LC<sub>50</sub> value (as defined in 2.6.2.1) equal to or less than 5,000 ml/m<sup>3</sup> (ppm).

**Note:** Gases meeting the above criteria owing to their corrosivity are to be classified as toxic with a subsidiary corrosive risk.

#### 2.2.2.4 Gases and gas mixtures with hazards associated with more than one division take the following precedence:

- .1 class 2.3 takes precedence over all other classes;
- .2 class 2.1 takes precedence over class 2.2.

#### 2.2.2.5 Gases of class 2.2 are not subject to the provisions of this Code if they are transported at a pressure of less than 200 kPa at 20°C and are not liquefied or refrigerated liquefied gases.

#### 2.2.2.6 Gases of class 2.2 are not subject to the provisions of this Code when contained in the following:

- .1 Foodstuffs (except UN 1950), including carbonated beverages;
- .2 Balls intended for use in sports;
- .3 Tyres (except for air transport); or
- .4 Light bulbs provided they are packaged so that the projectile effects of any rupture of the bulb will be contained within the package.

### 2.2.3 Mixtures of gases

For the classification of gas mixtures (including vapours of substances from other classes), the following principles shall be used:

- .1 Flammability shall be determined by tests or calculation in accordance with methods adopted by the International Organization for Standardization (see ISO Standard 10156:2010). Where insufficient data are available to use these methods, tests by a comparable method recognized by a national competent authority may be used.
- .2 The level of toxicity is determined either by tests to measure the LC<sub>50</sub> value (as defined in 2.6.2.1) or by a calculation method using the following formula:

$$LC_{50} \text{ Toxic (mixture)} = \frac{1}{\sum_{i=1}^n \frac{f_i}{T_i}}$$

where:  $f_i$  = mole fraction of the  $i^{\text{th}}$  component substance of the mixture;

$T_i$  = toxicity index of the  $i^{\text{th}}$  component substance of the mixture (the  $T_i$  equals the LC<sub>50</sub> value when available).

When LC<sub>50</sub> values are unknown, the toxicity index is determined by using the lowest LC<sub>50</sub> value of substances of similar physiological and chemical effects, or through testing if this is the only practical possibility.

## Part 2 – Classification

- .3 A gas mixture has a subsidiary risk of corrosivity when the mixture is known by human experience to be destructive to the skin, eyes or mucous membranes or when the LC<sub>50</sub> value of the corrosive components of the mixture is equal to or less than 5,000 mℓ/m<sup>3</sup> (ppm) when the LC<sub>50</sub> is calculated by the formula:

$$\text{LC}_{50} \text{ Corrosive (mixture)} = \frac{1}{\sum_{i=1}^n \frac{f_{ci}}{T_{ci}}}$$

where:  $f_{ci}$  = mole fraction of the  $i^{\text{th}}$  corrosive component substance of the mixture;

$T_{ci}$  = toxicity index of the  $i^{\text{th}}$  corrosive component substance of the mixture (the  $T_{ci}$  equals the LC<sub>50</sub> value when available).

- .4 Oxidizing ability is determined either by tests or by calculation methods adopted by the International Organization for Standardization (see note in 2.2.2.2).



## Chapter 2.3

---

### Class 3 – Flammable liquids

#### 2.3.0 Introductory note

The flashpoint of a flammable liquid may be altered by the presence of an impurity. The substances listed in class 3 in the Dangerous Goods List in chapter 3.2 shall generally be regarded as chemically pure. Since commercial products may contain added substances or impurities, flashpoints may vary, and this may have an effect on classification or determination of the packing group for the product. In the event of doubt regarding the classification or packing group of a substance, the flashpoint of the substance shall be determined experimentally.

#### 2.3.1 Definitions and general provisions

2.3.1.1 Class 3 includes the following substances:

- .1 flammable liquids (see 2.3.1.2 and 2.3.1.3);
- .2 liquid desensitized explosives (see 2.3.1.4).

2.3.1.2 *Flammable liquids* are liquids, or mixtures of liquids, or liquids containing solids in solution or suspension (such as paints, varnishes, lacquers, etc., but not including substances which, on account of their other dangerous characteristics, have been included in other classes) which give off a flammable vapour at or below 60°C closed-cup test (corresponding to 65.6°C open-cup test), normally referred to as the “flashpoint”. This also includes:

- .1 liquids offered for transport at temperatures at or above their flashpoint; and
- .2 substances transported or offered for transport at elevated temperatures in a liquid state, which give off a flammable vapour at temperatures equal to or below the maximum transport temperature.

2.3.1.3 However, the provisions of this Code need not apply to such liquids with a flashpoint of more than 35°C which do not sustain combustion. Liquids are considered to be unable to sustain combustion for the purposes of the Code if:

- .1 they have passed the suitable combustibility test (see the Sustained Combustibility Test prescribed in part III, 32.5.2 of the United Nations *Manual of Tests and Criteria*); or
- .2 their fire point according to ISO 2592:1973 is greater than 100°C; or
- .3 they are water-miscible solutions with a water content of more than 90%, by mass.

2.3.1.4 *Liquid desensitized explosives* are explosive substances which are dissolved or suspended in water or other liquid substances, to form a homogeneous liquid mixture to suppress their explosive properties. Entries in the Dangerous Goods List for liquid desensitized explosives are UN 1204, UN 2059, UN 3064, UN 3343, UN 3357 and UN 3379.

#### 2.3.2 Assignment of packing group

2.3.2.1 The criteria in 2.3.2.6 are used to determine the hazard grouping of a liquid that presents a risk due to flammability.

2.3.2.1.1 For liquids whose only risk is flammability, the packing group for the substance is the hazard grouping shown in 2.3.2.6.

2.3.2.1.2 For a liquid with additional risk(s), the hazard group determined from 2.3.2.6 and the hazard group based on the severity of the additional risk(s) shall be considered, and the classification and packing group determined in accordance with the provisions in chapter 2.0.

Part 2 – Classification

2.3.2.2 Viscous substances such as paints, enamels, lacquers, varnishes, adhesives and polishes having a flashpoint of less than 23°C may be placed in packing group III in conformity with the procedures prescribed in part III, chapter 32.3, of the United Nations *Manual of Tests and Criteria* on the basis of:

- .1 the viscosity, expressed as the flowtime in seconds;
- .2 the closed-cup flashpoint;
- .3 a solvent separation test.

2.3.2.3 Viscous flammable liquids such as paints, enamels, varnishes, adhesives and polishes with a flashpoint of less than 23°C are included in packing group III provided that:

- .1 less than 3% of the clear solvent layer separates in the solvent separation test;
- .2 the mixture or any separated solvent does not meet the criteria for class 6.1 or class 8.
- .3 the viscosity and flashpoint are in accordance with the following table:

Flow time <i>t</i> in seconds	Jet diameter in mm	Flashpoint in °C c.c.
20 < <i>t</i> ≤ 60	4	above 17
60 < <i>t</i> ≤ 100	4	above 10
20 < <i>t</i> ≤ 32	6	above 5
32 < <i>t</i> ≤ 44	6	above -1
44 < <i>t</i> ≤ 100	6	above -5
100 < <i>t</i>	6	-5 and below

- .4 the capacity of the receptacle used does not exceed 30 ℓ.

2.3.2.4 Substances classified as flammable liquids due to their being transported or offered for transport at elevated temperatures are included in packing group III.

2.3.2.5 Viscous substances which:

- have a flashpoint of 23°C or above and less than or equal to 60°C;
- are not toxic, corrosive or environmentally hazardous;
- contain not more than 20% nitrocellulose, provided the nitrocellulose contains not more than 12.6% nitrogen by dry mass; and
- are packed in receptacles not exceeding 30 ℓ capacity

are not subject to the provisions for the marking, labelling and testing of packages in chapters 4.1, 5.2 and 6.1, if:

- .1 in the solvent separation test (see part III, 32.5.1 of the United Nations *Manual of Tests and Criteria*) the height of the separated layer of solvent is less than 3% of the total height; and
- .2 the flowtime in the viscosity test (see part III, 32.4.3 of the United Nations *Manual of Tests and Criteria*) with a jet diameter of 6 mm is equal to or greater than:
  - .1 60 s; or
  - .2 40 s if the viscous substance contains not more than 60% of class 3 substances.

The following statement shall be included in the transport document: "Transport in accordance with 2.3.2.5 of the IMDG Code." (see 5.4.1.5.10).

2.3.2.6 Hazard grouping based on flammability

Flammable liquids are grouped for packing purposes according to their flashpoint, their boiling point, and their viscosity. This table shows the relationship between two of these characteristics.

Packing group	Flashpoint in °C closed cup (c.c.)	Initial boiling point in °C
I	–	≤ 35
II	< 23	> 35
III	≥ 23 to ≤ 60	> 35

### 2.3.3 Determination of flashpoint

**Note:** The provisions of this section are not mandatory.

2.3.3.1 The flashpoint of a flammable liquid is the lowest temperature of the liquid at which its vapour forms an ignitable mixture with air. It gives a measure of the risk of formation of explosive or ignitable mixtures when the liquid escapes from its packing. A flammable liquid cannot be ignited so long as its temperature remains below the flashpoint.

**Note:** Do not confuse the flashpoint with the ignition temperature, which is the temperature to which an explosive vapour–air mixture must be heated to cause actual explosion. There is no relationship between the flashpoint and the ignition temperature.

2.3.3.2 The flashpoint is not an exact physical constant for a given liquid. It depends to some extent on the construction of the test apparatus used and on the testing procedure. Therefore, when providing flashpoint data, specify the name of the test apparatus.

2.3.3.3 Several standard apparatuses are in current use. They all operate on the same principle: a specified quantity of the liquid is introduced into a receptacle at a temperature well below the flashpoint to be expected, then slowly heated; periodically, a small flame is brought near to the surface of the liquid. The flashpoint is the lowest temperature at which a “flash” is observed.

2.3.3.4 The test methods can be divided into two groups, depending on the use in an apparatus of an open receptacle (open-cup methods) or a closed one which is only opened to admit the flame (closed-cup methods). As a rule, the flashpoints found in an open-cup test are a few degrees higher than in a closed-cup test.

2.3.3.5 In general, reproducibility in closed-cup apparatus is better than in open-cup.

2.3.3.5.1 It is therefore recommended that flashpoints, especially in the range around 23°C, shall be determined by means of closed-cup (c.c) methods.

2.3.3.5.2 Flashpoint data in this Code are generally based on closed-cup methods. In countries where it is customary to determine flashpoints by the open-cup method, the temperatures given by that method would need to be reduced to correspond with those in this Code.

#### 2.3.3.6 Determination of flashpoint

The following methods for determining the flashpoint of flammable liquids may be used:

**International standards:**

ISO 1516  
ISO 1523  
ISO 2719  
ISO 13736  
ISO 3679  
ISO 3680

**National standards:**

American Society for Testing Materials International, 100 Barr Harbor Drive, PO Box C700, West Conshohocken, Pennsylvania, USA 19428-2959:

ASTM D3828-07a, Standard Test Methods for Flash Point by Small Scale Closed Cup Tester  
ASTM D56-05, Standard Test Method for Flash Point by Tag Closed Cup Tester  
ASTM D3278-96(2004)e, Standard Test Methods for Flash Point of Liquids by Small Scale Closed-Cup Apparatus  
ASTM D93-08, Standard Test Methods for Flash Point by Pensky-Martens Closed Cup Tester.

Association française de normalisation, AFNOR, 11, rue de Pressensé, 93571 La Plaine Saint-Denis Cedex:

French Standard NF M 07-019  
French Standards NF M 07-011/NF T 30-050/NF T 66-009  
French Standard NF M 07-036

Deutsches Institut für Normung, Burggrafenstr. 6, D-10787 Berlin:

Standard DIN 51755 (flashpoints below 65°C)

State Committee of the Council of Ministers for Standardization, 113813, GSP, Moscow, M-49 Leninsky Prospect, 9:

GOST 12.1.044-84

### 2.3.4 Determination of initial boiling point

The following methods for determining the initial boiling point of flammable liquids may be used:

**International standards:**

- ISO 3924
- ISO 4626
- ISO 3405

**National standards:**

American Society for Testing Materials International, 100 Barr Harbor Drive, PO Box C700,  
West Conshohocken, Pennsylvania, USA 19428-2959:

- ASTM D86-07a, Standard Test Method for Distillation of Petroleum Products at Atmospheric Pressure
- ASTM D1078-05, Standard Test Method for Distillation Range of Volatile Organic Liquids

**Further acceptable methods:**

Method A.2 as described in Part A of the Annex to Commission Regulation (EC) No 440/2008.\*

---

\* Commission Regulation (EC) No 440/2008 of 30 May 2008 laying down test methods pursuant to Regulation (EC) No 1907/2006 of the European Parliament and of the Council on the Registration, Evaluation, Authorisation and Restriction of Chemicals (REACH) (Official Journal of the European Union, No L 142 of 31.05.2008, pages 1–739 and No L 143 of 03.06.2008, page 55).

## Chapter 2.4

---

### *Class 4 – Flammable solids; substances liable to spontaneous combustion; substances which, in contact with water, emit flammable gases*

#### 2.4.0 Introductory note

Since organometallic substances can be classified in classes 4.2 or 4.3 with additional subsidiary risks, depending on their properties, a specific classification flowchart for these substances is given in 2.4.5.

#### 2.4.1 Definition and general provisions

2.4.1.1 In this Code, class 4 deals with substances, other than those classified as explosives, which, under conditions of transport, are readily combustible or may cause or contribute to a fire. Class 4 is subdivided as follows:

##### Class 4.1 – Flammable solids

Solids which, under conditions encountered in transport, are readily combustible or may cause or contribute to fire through friction; self-reactive substances (solids and liquids) which are liable to undergo a strongly exothermic reaction; solid desensitized explosives which may explode if not diluted sufficiently;

##### Class 4.2 – Substances liable to spontaneous combustion

Substances (solids and liquids) which are liable to spontaneous heating under normal conditions encountered in transport, or to heating up in contact with air, and being then liable to catch fire;

##### Class 4.3 – Substances which, in contact with water, emit flammable gases

Substances (solids and liquids) which, by interaction with water, are liable to become spontaneously flammable or to give off flammable gases in dangerous quantities.

2.4.1.2 As referenced in this chapter, test methods and criteria, with advice on application of the tests, are given in the United Nations *Manual of Tests and Criteria* for the classification of following types of substances of class 4:

- .1 flammable solids (class 4.1);
- .2 self-reactive substances (class 4.1);
- .3 pyrophoric solids (class 4.2);
- .4 pyrophoric liquids (class 4.2);
- .5 self-heating substances (class 4.2); and
- .6 substances which, in contact with water, emit flammable gases (class 4.3).

Test methods and criteria for self-reactive substances are given in part II of the United Nations *Manual of Tests and Criteria*, and test methods and criteria for the other types of substances of class 4 are given in the United Nations *Manual of Tests and Criteria*, part III, chapter 33.

#### 2.4.2 Class 4.1 – Flammable solids, self-reactive substances and solid desensitized explosives

##### 2.4.2.1 General

Class 4.1 includes the following types of substances:

- .1 flammable solids (see 2.4.2.2);

## Part 2 – Classification

- .2 self-reactive substances (see 2.4.2.3); and
- .3 solid desensitized explosives (see 2.4.2.4).

Some substances (such as celluloid) may evolve toxic and flammable gases when heated or if involved in a fire.

## 2.4.2.2 Class 4.1 Flammable solids

## 2.4.2.2.1 Definitions and properties

2.4.2.2.1.1 For the purpose of this Code, *flammable solids* means readily combustible solids and solids which may cause fire through friction.

2.4.2.2.1.2 *Readily combustible solids* means fibres, powdered, granular, or pasty substances which are dangerous if they can be easily ignited by brief contact with an ignition source such as a burning match, and if the flame spreads rapidly. The danger may come not only from the fire but also from toxic combustion products. Metal powders are especially dangerous because of the difficulty of extinguishing a fire, since normal extinguishing agents such as carbon dioxide or water can increase the hazard.

## 2.4.2.2.2 Classification of flammable solids

2.4.2.2.2.1 Powdered, granular or pasty substances shall be classified as readily combustible solids of class 4.1 when the time of burning of one or more of the test runs, performed in accordance with the test method described in the United Nations *Manual of Tests and Criteria*, part III, 33.2.1, is less than 45 s or the rate of burning is more than 2.2 mm/s. Powders of metals or metal alloys shall be classified in class 4.1 when they can be ignited and the reaction spreads over the whole length of the sample in 10 minutes or less.

2.4.2.2.2.2 Solids which may cause fire through friction shall be classified in class 4.1 by analogy with existing entries (such as matches) until definitive criteria are established.

## 2.4.2.2.3 Assignment of packing groups

2.4.2.2.3.1 Packing groups are assigned on the basis of the test methods referred to in 2.4.2.2.2.1. For readily combustible solids (other than metal powders), packing group II shall be assigned if the burning time is less than 45 s and the flame passes the wetted zone. Packing group II shall be assigned to powders of metal or metal alloys if the zone of reaction spreads over the whole length of the sample in five minutes or less.

2.4.2.2.3.2 Packing groups are assigned on the basis of the test methods referred to in 2.4.2.2.2.1. For readily combustible solids (other than metal powders), packing group III shall be assigned if the burning time is less than 45 s and the wetted zone stops the flame propagation for at least four minutes. Packing group III shall be assigned to metal powders if the reaction spreads over the whole length of the sample in more than five minutes but not more than ten minutes.

2.4.2.2.3.3 For solids which may cause fire through friction, the packing group shall be assigned by analogy with existing entries or in accordance with any appropriate special provision.

2.4.2.2.4 Pyrophoric metal powders, if wetted with sufficient water to suppress their pyrophoric properties, may be classified as class 4.1.

## 2.4.2.3 Class 4.1 Self-reactive substances

## 2.4.2.3.1 Definitions and properties

2.4.2.3.1.1 For the purposes of this Code:

*Self-reactive substances* are thermally unstable substances liable to undergo a strongly exothermic decomposition even without participation of oxygen (air). Substances are not considered to be self-reactive substances of class 4.1, if:

- .1 they are explosives according to the criteria of class 1;
- .2 they are oxidizing substances according to the classification procedure for class 5.1 (see 2.5.2) except that mixtures of oxidizing substances which contain 5.0% or more of combustible organic substances shall be subjected to the classification procedure defined in Note 3;
- .3 they are organic peroxides according to the criteria of class 5.2;
- .4 their heat of decomposition is less than 300 J/g; or
- .5 their self-accelerating decomposition temperature (SADT) (see 2.4.2.3.4) is greater than 75°C for a 50 kg package.

**Note 1:** The heat of decomposition may be determined using any internationally recognized method such as differential scanning calorimetry and adiabatic calorimetry.

**Note 2:** Any substance which shows the properties of a self-reactive substance shall be classified as such, even if this substance gives a positive test result according to 2.4.3.2 for inclusion in class 4.2.

**Note 3:** Mixtures of oxidizing substances meeting the criteria of class 5.1 which contain 5.0% or more of combustible organic substances, which do not meet the criteria mentioned in .1, .3, .4 or .5 above, shall be subjected to the self-reactive substance classification procedure.

A mixture showing the properties of a self-reactive substance, type B to F, shall be classified as a self-reactive substance of class 4.1.

A mixture showing the properties of a self-reactive substance, type G, according to the principle of 2.4.2.3.3.2.7 shall be considered for classification as a substance of class 5.1 (see 2.5.2).

**2.4.2.3.1.2** The decomposition of self-reactive substances can be initiated by heat, contact with catalytic impurities (such as acids, heavy-metal compounds, bases), friction or impact. The rate of decomposition increases with temperature and varies with the substance. Decomposition, particularly if no ignition occurs, may result in the evolution of toxic gases or vapours. For certain self-reactive substances, the temperature shall be controlled. Some self-reactive substances may decompose explosively, particularly if confined. This characteristic may be modified by the addition of diluents or by the use of appropriate packagings. Some self-reactive substances burn vigorously. Self-reactive substances are, for example, some compounds of the types listed below:

- .1 aliphatic azo compounds ( $-C-N=N-C-$ );
- .2 organic azides ( $-C-N_3$ );
- .3 diazonium salts ( $-CN_2^+ Z^-$ );
- .4 *N*-nitroso compounds ( $-N=N=O$ ); and
- .5 aromatic sulphohydrazides ( $-SO_2-NH-NH_2$ ).

This list is not exhaustive and substances with other reactive groups and some mixtures of substances may have similar properties.

#### 2.4.2.3.2 Classification of self-reactive substances

**2.4.2.3.2.1** Self-reactive substances are classified into seven types according to the degree of danger they present. The types of self-reactive substance range from type A, which may not be accepted for transport in the packaging in which it is tested, to type G, which is not subject to the provisions for self-reactive substances of class 4.1. The classification of types B to F is directly related to the maximum quantity allowed in one packaging.

**2.4.2.3.2.2** Self-reactive substances permitted for transport in packagings are listed in 2.4.2.3.2.3, those permitted for transport in IBCs are listed in packing instruction IBC520 and those permitted for transport in portable tanks are listed in portable tank instruction T23. For each permitted substance listed, the appropriate generic entry of the Dangerous Goods List (UN 3221 to UN 3240) is assigned, and appropriate subsidiary risks and remarks providing relevant transport information are given. The generic entries specify:

- .1 self-reactive substance type (B to F);
- .2 physical state (liquid or solid); and
- .3 temperature control, when required (2.4.2.3.4).

#### 2.4.2.3.2.3 List of currently assigned self-reactive substances in packagings

In the column "Packing Method" codes "OP1" to "OP8" refer to packing methods in packing instruction P520. Self-reactive substances to be transported shall fulfill the classification and the control and emergency temperatures (derived from the SADT) as listed. For substances permitted in IBCs, see packing instruction IBC520, and for those permitted in tanks, see portable tank instruction T23.

**Note:** The classification given in this table is based on the technically pure substance (except where a concentration of less than 100% is specified). For other concentrations, the substances may be classified differently following the procedures in 2.4.2.3.3 and 2.4.2.3.4.

UN generic entry	SELF-REACTIVE SUBSTANCE	Concentration (%)	Packing method	Control temperature (°C)	Emergency temperature (°C)	Remarks
3222	2-DIAZO-1-NAPHTHOL-4-SULPHONYL CHLORIDE	100	OP5			(2)
	2-DIAZO-1-NAPHTHOL-5-SULPHONYL CHLORIDE	100	OP5			(2)
3223	SELF-REACTIVE LIQUID, SAMPLE		OP2			(8)

Part 2 – Classification

UN generic entry	SELF-REACTIVE SUBSTANCE	Concentration (%)	Packing method	Control temperature (°C)	Emergency temperature (°C)	Remarks
3224	AZODICARBONAMIDE FORMULATION TYPE C	< 100	OP6			(3)
	2,2'-AZODI(I SOBUTYRONITRILE) as a water-based paste	≤ 50	OP6			
	N,N'-DINITROSO-N,N'-DIMETHYL-TEREPHTHALAMIDE, as a paste	72	OP6			
	N,N'-DINITROSO-PENTAMETHYLENETETRAMINE	82	OP6			(7)
	SELF-REACTIVE SOLID, SAMPLE		OP2			(8)
3226	AZODICARBONAMIDE FORMULATION TYPE D	< 100	OP7			(5)
	1,1'-AZODI(HEXAHYDROBENZONITRILE)	100	OP7			
	BENZENE-1,3-DISULPHONYL HYDRAZIDE as a paste	52	OP7			
	BENZENESULPHONYL HYDRAZIDE	100	OP7			
	4-(BENZYL(ETHYL)AMINO)-3-ETHOXY-BENZENEDIAZONIUM ZINC CHLORIDE	100	OP7			
	3-CHLORO-4-DIETHYLAMINO BENZENE-DIAZONIUM ZINC CHLORIDE	100	OP7			
	2-DIAZO-1-NAPHTHOLSULPHONIC ACID ESTER MIXTURE TYPE D	< 100	OP7			(9)
	2,5-DIETHOXY-4-(4-MORPHOLINYL)-BENZENEDIAZONIUM SULPHATE	100	OP7			
	DIPHENYLOXIDE-4,4'-DISULPHONYL HYDRAZIDE	100	OP7			
	4-DIPROPYLAMINO BENZENEDIAZONIUM ZINC CHLORIDE	100	OP7			
	4-METHYLBENZENESULPHONYLHYDRAZIDE	100	OP7			
SODIUM 2-DIAZO-1-NAPHTHOL-4-SULPHONATE	100	OP7				
SODIUM 2-DIAZO-1-NAPHTHOL-5-SULPHONATE	100	OP7				
3228	ACETONE-PYROGALLOL COPOLYMER	100	OP8			
	2-DIAZO-1-NAPHTHOL-5-SULPHONATE					
	4-(DIMETHYLAMINO)BENZENEDIAZONIUM TRICHLOROZINCATE(-1)	100	OP8			
	2,5-DIBUTOXY-4-(4-MORPHOLINYL)-BENZENEDIAZONIUM TETRACHLOROZINCATE(2:1)	100	OP8			
3232	AZODICARBONAMIDE FORMULATION TYPE B, TEMPERATURE CONTROLLED	< 100	OP5			(1) (2)
3233	SELF-REACTIVE LIQUID, SAMPLE, TEMPERATURE CONTROLLED		OP2			(8)
3234	AZODICARBONAMIDE FORMULATION TYPE C, TEMPERATURE CONTROLLED	< 100	OP6			(4)
	2,2'-AZODI(I SOBUTYRONITRILE)	100	OP6	+40	+45	
	3-METHYL-4-(PYRROLIDIN-1-YL)BENZENE-DIAZONIUM TETRAFLUOROBORATE	95	OP6	+45	+50	
	SELF-REACTIVE SOLID, SAMPLE, TEMPERATURE CONTROLLED		OP2			(8)
	TETRAMINE-PALLADIUM(II) NITRATE	100	OP6	+30	+35	
3235	2,2'-AZODI(ETHYL-2-METHYLPROPIONATE)	100	OP7	+20	+25	



UN generic entry	SELF-REACTIVE SUBSTANCE	Concentration (%)	Packing method	Control temperature (°C)	Emergency temperature (°C)	Remarks
3236	AZODICARBONAMIDE FORMULATION TYPE D, TEMPERATURE CONTROLLED	< 100	OP7			(6)
	2,2'-AZODI(2,4-DIMETHYL-4-METHOXY-VALERONITRILE)	100	OP7	-5	+5	
	2,2'-AZODI(2,4-DIMETHYLVALERONITRILE)	100	OP7	+10	+15	
	2,2'-AZODI(2-METHYLBUTYRONITRILE)	100	OP7	+35	+40	
	4-(BENZYL(METHYL)AMINO)-3-ETHOXY-BENZENEDIAZONIUM ZINC CHLORIDE	100	OP7	+40	+45	
	2,5-DIETHOXY-4-MORPHOLINO-BENZENEDIAZONIUM ZINC CHLORIDE	67-100	OP7	+35	+40	
	2,5-DIETHOXY-4-MORPHOLINO-BENZENEDIAZONIUM ZINC CHLORIDE	66	OP7	+40	+45	
	2,5-DIETHOXY-4-MORPHOLINO-BENZENEDIAZONIUM TETRAFLUOROBORATE	100	OP7	+30	+35	
	2,5-DIETHOXY-4-(PHENYLSULPHONYL)-BENZENEDIAZONIUM ZINC CHLORIDE	67	OP7	+40	+45	
	2,5-DIMETHOXY-4-(4-METHYLPHENYLSULPHONYL)BENZENEDIAZONIUM ZINC CHLORIDE	79	OP7	+40	+45	
	4-DIMETHYLAMINO-6-(2-DIMETHYLAMINO-ETHOXY)TOLUENE-2-DIAZONIUM ZINC CHLORIDE	100	OP7	+40	+45	
	2-(N,N-ETHOXYCARBONYLPHENYLAMINO)-3-METHOXY-4-(N-METHYL-N-CYCLOHEXYLAMINO)-BENZENEDIAZONIUM ZINC CHLORIDE	63-92	OP7	+40	+45	
	2-(N,N-ETHOXYCARBONYLPHENYLAMINO)-3-METHOXY-4-(N-METHYL-N-CYCLOHEXYLAMINO)-BENZENEDIAZONIUM ZINC CHLORIDE	62	OP7	+35	+40	
	N-FORMYL-2-(NITROMETHYLENE)-1,3-PERHYDROTHIAZINE	100	OP7	+45	+50	
	2-(2-HYDROXYETHOXY)-1-(PYRROLIDIN-1-YL)-BENZENE-4-DIAZONIUM ZINC CHLORIDE	100	OP7	+45	+50	
	3-(2-HYDROXYETHOXY)-4-(PYRROLIDIN-1-YL)-BENZENEDIAZONIUM ZINC CHLORIDE	100	OP7	+40	+45	
	2-(N,N-METHYLAMINOETHYL-CARBONYL)-4-(3,4-DIMETHYLPHENYLSULPHONYL)-BENZENEDIAZONIUM HYDROGEN SULPHATE	96	OP7	+45	+50	
	4-NITROSOPHENOL	100	OP7	+35	+40	
3237	DIETHYLENEGLYCOL BIS(ALLYLCARBONATE) + DI-ISOPROPYL PEROXYDICARBONATE	≥ 88 + ≤ 12	OP8	-10	0	

Remarks

- (1) Azodicarbonamide formulations which fulfil the criteria of 2.4.2.3.3.2.2. The control and emergency temperatures shall be determined by the procedure given in 7.3.7.2.
- (2) "EXPLOSIVE" subsidiary risk label (Model No 1, see 5.2.2.2.2) required.
- (3) Azodicarbonamide formulations which fulfil the criteria of 2.4.2.3.3.2.3.
- (4) Azodicarbonamide formulations which fulfil the criteria of 2.4.2.3.3.2.3. The control and emergency temperatures shall be determined by the procedure given in 7.3.7.2.
- (5) Azodicarbonamide formulations which fulfil the criteria of 2.4.2.3.3.2.4.
- (6) Azodicarbonamide formulations which fulfil the criteria of 2.4.2.3.3.2.4. The control and emergency temperatures shall be determined by the procedure given in 7.3.7.2.
- (7) With a compatible diluent having a boiling point of not less than 150°C.
- (8) See 2.4.2.3.2.4.2.
- (9) This entry applies to mixtures of esters of 2-diazo-1-naphthol-4-sulphonic acid and 2-diazo-1-naphthol-5-sulphonic acid meeting the criteria of 2.4.2.3.3.2.4.

Part 2 – Classification

---

2.4.2.3.2.4 Classification of self-reactive substances not listed in 2.4.2.3.2.3, packing instruction IBC520 or portable tank instruction T23 and assignment to a generic entry shall be made by the competent authority of the country of origin on the basis of a test report. Principles applying to the classification of such substances are provided in 2.4.2.3.3. The applicable classification procedures, test methods and criteria, and an example of a suitable test report, are given in the United Nations *Manual of Tests and Criteria*, part II. The statement of approval shall contain the classification and the relevant transport conditions.

- .1 Activators, such as zinc compounds, may be added to some self-reactive substances to change their reactivity. Depending on both the type and the concentration of the activator, this may result in a decrease in thermal stability and a change in explosive properties. If either of these properties is altered, the new formulation shall be assessed in accordance with this classification procedure.
- .2 Samples of self-reactive substances or formulations of self-reactive substances not listed in 2.4.2.3.2.3, for which a complete set of test results is not available and which are to be transported for further testing or evaluation, may be assigned to one of the appropriate entries for self-reactive substances type C provided the following conditions are met:
  - .1 the available data indicate that the sample would be no more dangerous than self-reactive substances type B;
  - .2 the sample is packaged in accordance with packing method OP2 (see applicable packing instruction) and the quantity per cargo transport unit is limited to 10 kg; and
  - .3 the available data indicate that the control temperature, if any, is sufficiently low to prevent any dangerous decomposition and sufficiently high to prevent any dangerous phase separation.

2.4.2.3.3 *Principles for classification of self-reactive substances*

**Note:** This section refers only to those properties of self-reactive substances which are decisive for their classification. A flow chart, presenting the classification principles in the form of a graphically arranged scheme of questions concerning the decisive properties together with the possible answers, is given in Figure 2.4.1 in chapter 2.4 of the United Nations *Recommendations on the Transport of Dangerous Goods*. These properties shall be determined experimentally. Suitable test methods with pertinent evaluation criteria are given in the United Nations *Manual of Tests and Criteria*, part II.

2.4.2.3.3.1 A self-reactive substance is regarded as possessing explosive properties when, in laboratory testing, the formulation is liable to detonate, to deflagrate rapidly or to show a violent effect when heated under confinement.

2.4.2.3.3.2 The following principles apply to the classification of self-reactive substances not listed in 2.4.2.3.2.3:

- .1 Any substance which can detonate or deflagrate rapidly, as packaged for transport, is prohibited from transport under the provisions for self-reactive substances of class 4.1 in that packaging (defined as SELF-REACTIVE SUBSTANCE TYPE A);
- .2 Any substance possessing explosive properties and which, as packaged for transport, neither detonates nor deflagrates rapidly, but is liable to undergo a thermal explosion in that package, shall also bear an "EXPLOSIVE" subsidiary risk label (Model No. 1, see 5.2.2.2.2). Such a substance may be packaged in amounts of up to 25 kg unless the maximum quantity has to be limited to a lower amount to preclude detonation or rapid deflagration in the package (defined as SELF-REACTIVE SUBSTANCE TYPE B);
- .3 Any substance possessing explosive properties may be transported without an "EXPLOSIVE" subsidiary risk label when the substance as packaged (maximum 50 kg) for transport cannot detonate or deflagrate rapidly or undergo a thermal explosion (defined as SELF-REACTIVE SUBSTANCE TYPE C);
- .4 Any substance which, in laboratory testing:
  - .1 detonates partially, does not deflagrate rapidly and shows no violent effect when heated under confinement; or
  - .2 does not detonate at all, deflagrates slowly and shows no violent effect when heated under confinement; or
  - .3 does not detonate or deflagrate at all and shows a medium effect when heated under confinement may be accepted for transport in packages of not more than 50 kg net mass (defined as SELF-REACTIVE SUBSTANCE TYPE D);
- .5 Any substance which, in laboratory testing, neither detonates nor deflagrates at all and shows low or no effect when heated under confinement may be accepted for transport in packages of not more than 400 kg/450 ℓ (defined as SELF-REACTIVE SUBSTANCE TYPE E);

- .6 Any substance which, in laboratory testing, neither detonates in the cavitated state nor deflagrates at all and shows only a low or no effect when heated under confinement as well as low or no explosive power may be considered for transport in IBCs (defined as SELF-REACTIVE SUBSTANCE TYPE F); (for additional provisions see 4.1.7.2.2);
- .7 Any substance which, in laboratory testing, neither detonates in the cavitated state nor deflagrates at all and shows no effect when heated under confinement nor any explosive power shall be exempted from classification as a self-reactive substance of class 4.1 provided that the formulation is thermally stable (self-accelerating decomposition temperature 60°C to 75°C for a 50 kg package) and any diluent meets the provisions of 2.4.2.3.5 (defined as SELF-REACTIVE SUBSTANCE TYPE G). If the formulation is not thermally stable or a compatible diluent having a boiling point less than 150°C is used for desensitization, the formulation shall be defined as SELF-REACTIVE LIQUID/SOLID TYPE F.

**2.4.2.3.4 Temperature control provisions**

2.4.2.3.4.1 Self-reactive substances are subject to temperature control in transport if their self-accelerating decomposition temperature (SADT) is less than or equal to 55°C. For currently assigned self-reactive substances, the control and emergency temperatures are shown in 2.4.2.3.2.3. Test methods for determining the SADT are given in the United Nations *Manual of Tests and Criteria*, part II, chapter 28. The test selected shall be conducted in a manner which is representative, both in size and material, of the package to be transported. The temperature control provisions are given in 7.3.7.

**2.4.2.3.5 Desensitization of self-reactive substances**

2.4.2.3.5.1 In order to ensure safety during transport, self-reactive substances may be desensitized through the use of a diluent. If a diluent is used, the self-reactive substance shall be tested with the diluent present in the concentration and form used in transport.

2.4.2.3.5.2 Diluents which may allow a self-reactive substance to concentrate to a dangerous extent in the event of leakage from a package shall not be used.

2.4.2.3.5.3 The diluent shall be compatible with the self-reactive substance. In this regard, compatible diluents are those solids or liquids which have no detrimental influence on the thermal stability and hazard type of the self-reactive substance.

2.4.2.3.5.4 Liquid diluents in liquid formulations requiring temperature control shall have a boiling point of at least 60°C and a flashpoint not less than 5°C. The boiling point of the liquid shall be at least 50°C higher than the control temperature of the self-reactive substance (see 7.3.7.2).

**2.4.2.4 Class 4.1 Solid desensitized explosives**

**2.4.2.4.1 Definitions and properties**

2.4.2.4.1.1 Solid desensitized explosives are explosive substances which are wetted with water or alcohols or are diluted with other substances to form a homogeneous solid mixture to suppress their explosive properties. The desensitizing agent shall be distributed uniformly throughout the substance in the state in which it is to be transported. Where transport under conditions of low temperature is anticipated for substances containing or wetted with water, a suitable and compatible solvent, such as alcohol, may have to be added to lower the freezing point of the liquid. Some of these substances, when in a dry state, are classified as explosives. Where reference is made to a substance which is wetted with water, or some other liquid, it shall be permitted for transport as a class 4.1 substance only when in the wetted condition specified. Entries in the Dangerous Goods List in chapter 3.2 for solid desensitized explosives are UN 1310, UN 1320, UN 1321, UN 1322, UN 1336, UN 1337, UN 1344, UN 1347, UN 1348, UN 1349, UN 1354, UN 1355, UN 1356, UN 1357, UN 1517, UN 1571, UN 2555, UN 2556, UN 2557, UN 2852, UN 2907, UN 3317, UN 3319, UN 3344, UN 3364, UN 3365, UN 3366, UN 3367, UN 3368, UN 3369, UN 3370, UN 3376, UN 3380 and UN 3474.

**2.4.2.4.2 Substances that:**

- .1 have been provisionally accepted into class 1 according to Test Series 1 and 2 but exempted from class 1 by Test Series 6;
- .2 are not self-reactive substances of class 4.1;
- .3 are not substances of class 5

are also assigned to class 4.1. UN 2956, UN 3241, UN 3242 and UN 3251 are such entries.

## Part 2 – Classification

## 2.4.3 Class 4.2 – Substances liable to spontaneous combustion

## 2.4.3.1 Definitions and properties

## 2.4.3.1.1 Class 4.2 comprises:

- .1 *Pyrophoric substances*, which are substances, including mixtures and solutions (liquid or solid), which, even in small quantities, ignite within 5 minutes of coming into contact with air. These substances are the most liable to spontaneous combustion; and
- .2 *Self-heating substances*, which are substances, other than pyrophoric substances, which, in contact with air without energy supply, are liable to self-heating. These substances will ignite only when in large amounts (kilograms) and after long periods of time (hours or days).

2.4.3.1.2 Self-heating of a substance is a process where the gradual reaction of that substance with oxygen (in air) generates heat. If the rate of heat production exceeds the rate of heat loss, then the temperature of the substance will rise which, after an induction time, may lead to self-ignition and combustion.

2.4.3.1.3 Some substances may also give off toxic gases if involved in a fire.

## 2.4.3.2 Classification of class 4.2 substances

2.4.3.2.1 Solids are considered pyrophoric solids which shall be classified in class 4.2 if, in tests performed in accordance with the test method given in the United Nations *Manual of Tests and Criteria*, part III, 33.3.1.4, the sample ignites in one of the tests.

2.4.3.2.2 Liquids are considered pyrophoric liquids which shall be classified in class 4.2 if, in tests performed in accordance with the test method given in the United Nations *Manual of Tests and Criteria*, part III, 33.3.1.5, the liquid ignites in the first part of the test, or if it ignites or chars the filter paper.

2.4.3.2.3 *Self-heating substances*

2.4.3.2.3.1 A substance shall be classified as a self-heating substance of class 4.2 if, in tests performed in accordance with the test method given in the United Nations *Manual of Tests and Criteria*, part III, 33.3.1.6:

- .1 a positive result is obtained using a 25 mm cube sample at 140°C;
- .2 a positive result is obtained in a test using a 100 mm cube sample at 140°C and a negative result is obtained in a test using a 100 mm cube sample at 120°C and the substance is to be transported in packages with a volume of more than 3 m<sup>3</sup>;
- .3 a positive result is obtained in a test using a 100 mm cube sample at 140°C and a negative result is obtained in a test using a 100 mm cube sample at 100°C and the substance is to be transported in packages with a volume of more than 450 ℓ;
- .4 a positive result is obtained in a test using a 100 mm cube sample at 140°C and a positive result is obtained using a 100 mm cube sample at 100°C.

**Note:** Self-reactive substances, except for type G, giving also a positive result with this test method shall not be classified in class 4.2 but in class 4.1 (see 2.4.2.3.1.1).

2.4.3.2.3.2 A substance shall not be classified in class 4.2 if:

- .1 a negative result is obtained in a test using a 100 mm cube sample at 140°C;
- .2 a positive result is obtained in a test using a 100 mm cube sample at 140°C and a negative result is obtained in a test using a 25 mm cube sample at 140°C, a negative result is obtained in a test using a 100 mm cube sample at 120°C and the substance is to be transported in packages with a volume not more than 3 m<sup>3</sup>;
- .3 a positive result is obtained in a test using a 100 mm cube sample at 140°C and a negative result is obtained in a test using a 25 mm cube sample at 140°C, a negative result is obtained in a test using a 100 mm cube sample at 100°C and the substance is to be transported in packages with a volume not more than 450 ℓ.

## 2.4.3.3 Assignment of packing groups

2.4.3.3.1 Packing group I shall be assigned to all pyrophoric solids and liquids.

2.4.3.3.2 Packing group II shall be assigned to self-heating substances which give a positive result in a test using a 25 mm cube sample at 140°C.

- 2.4.3.3.3 Packing group III shall be assigned to self-heating substances if:
- .1 a positive result is obtained in a test using a 100 mm cube sample at 140°C and a negative result is obtained in a test using a 25 mm cube sample at 140°C and the substance is to be transported in packages with a volume of more than 3 m<sup>3</sup>;
  - .2 a positive result is obtained in a test using a 100 mm cube sample at 140°C and a negative result is obtained in a test using a 25 mm cube sample at 140°C, a positive result is obtained in a test using a 100 mm cube sample at 120°C and the substance is to be transported in packages with a volume of more than 450 ℓ;
  - .3 a positive result is obtained in a test using a 100 mm cube sample at 140°C and a negative result is obtained in a test using a 25 mm cube sample at 140°C and a positive result is obtained in a test using a 100 mm cube sample at 100°C.

## 2.4.4 Class 4.3 – Substances which, in contact with water, emit flammable gases

### 2.4.4.1 Definitions and properties

2.4.4.1.1 For the purpose of this Code, the substances in this class are either liquids or solids which, by interaction with water, are liable to become spontaneously flammable or to give off flammable gases in dangerous quantities.

2.4.4.1.2 Certain substances, in contact with water, may emit flammable gases that can form explosive mixtures with air. Such mixtures are easily ignited by all ordinary sources of ignition, for example naked lights, sparking handtools or unprotected light bulbs. The resulting blast wave and flames may endanger people and the environment. The test method referred to in 2.4.4.2 is used to determine whether the reaction of a substance with water leads to the development of a dangerous amount of gases which may be flammable. This test method shall not be applied to pyrophoric substances.

### 2.4.4.2 Classification of class 4.3 substances

2.4.4.2.1 Substances which, in contact with water, emit flammable gases shall be classified in class 4.3 if, in tests performed in accordance with the test method given in the United Nations *Manual of Tests and Criteria*, part III, 33.4.1:

- .1 spontaneous ignition takes place in any step of the test procedure; or
- .2 there is an evolution of a flammable gas at a rate greater than 1 litre per kilogram of the substance per hour.

### 2.4.4.3 Assignment of packing groups

2.4.4.3.1 Packing group I shall be assigned to any substance which reacts vigorously with water at ambient temperatures and demonstrates generally a tendency for the gas produced to ignite spontaneously, or which reacts readily with water at ambient temperatures such that the rate of evolution of flammable gas is equal to or greater than 10 litres per kilogram of substance over any one minute.

2.4.4.3.2 Packing group II shall be assigned to any substance which reacts readily with water at ambient temperatures such that the maximum rate of evolution of flammable gas is equal to or greater than 20 litres per kilogram of substance per hour, and which does not meet the criteria for packing group I.

2.4.4.3.3 Packing group III shall be assigned to any substance which reacts slowly with water at ambient temperatures such that the maximum rate of evolution of flammable gas is equal to or greater than 1 litre per kilogram of substance per hour, and which does not meet the criteria for packing groups I or II.

## 2.4.5 Classification of organometallic substances

Depending on their properties, organometallic substances may be classified in classes 4.2 or 4.3, as appropriate, in accordance with the following flowchart:

Flowchart scheme for organometallic substances<sup>1,2</sup>

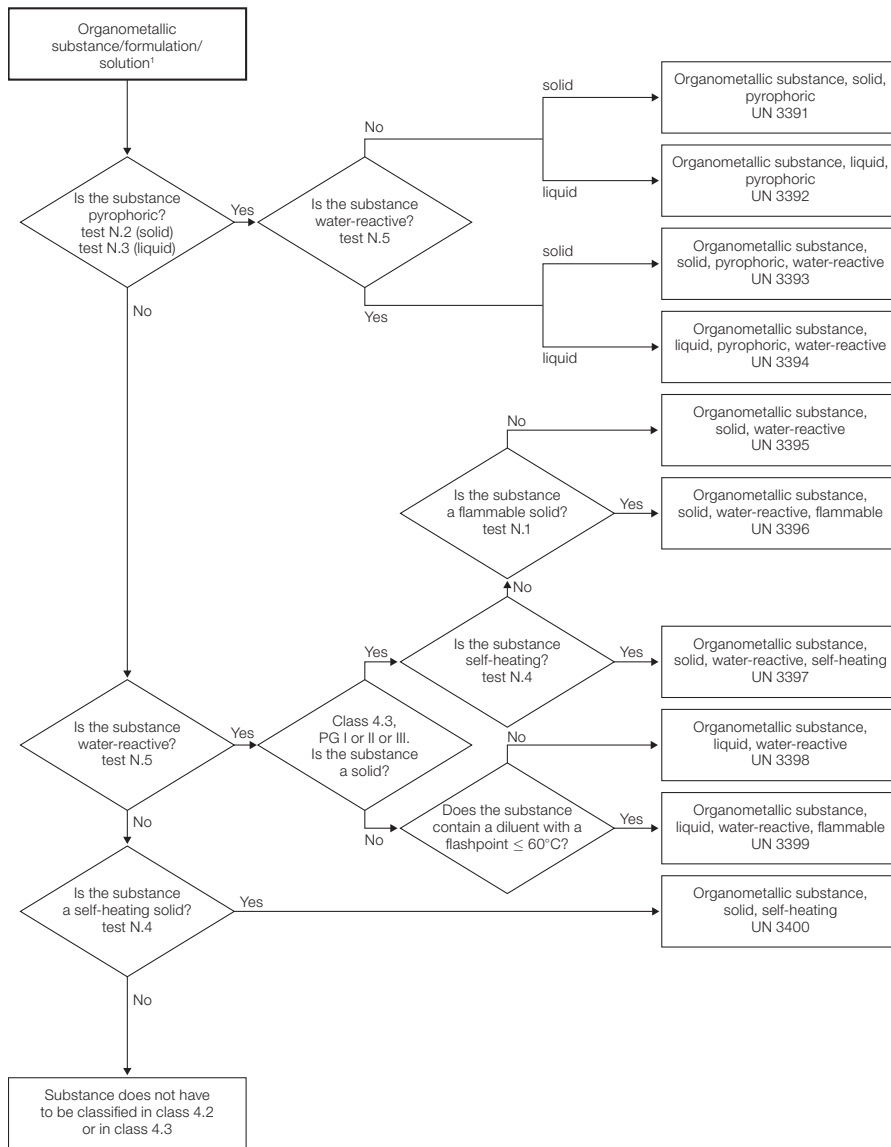

<sup>1</sup> If applicable and testing is relevant, taking into account reactivity properties, class 6.1 and class 8 properties shall be considered according to the Precedence of hazards table 2.0.3.6.

<sup>2</sup> Test methods N.1 to N.5 can be found in the United Nations *Manual of Tests and Criteria*, part III, section 33.

## Chapter 2.5

### *Class 5 – Oxidizing substances and organic peroxides*

#### 2.5.0 Introductory note

**Note:** Because of the differing properties exhibited by dangerous goods within classes 5.1 and 5.2, it is impracticable to establish a single criterion for classification in either class. Tests and criteria for assignment to the two classes are addressed in this chapter.

#### 2.5.1 Definitions and general provisions

In this Code, class 5 is divided into two classes as follows:

##### Class 5.1 – Oxidizing substances

Substances which, while in themselves not necessarily combustible, may, generally by yielding oxygen, cause, or contribute to, the combustion of other material. Such substances may be contained in an article;

##### Class 5.2 – Organic peroxides

Organic substances which contain the bivalent –O–O– structure and may be considered derivatives of hydrogen peroxide, where one or both of the hydrogen atoms have been replaced by organic radicals. Organic peroxides are thermally unstable substances which may undergo exothermic self-accelerating decomposition. In addition, they may have one or more of the following properties:

- be liable to explosive decomposition;
- burn rapidly;
- be sensitive to impact or friction;
- react dangerously with other substances;
- cause damage to the eyes.

#### 2.5.2 Class 5.1 – Oxidizing substances

**Note:** For the classification of oxidizing substances to class 5.1, in the event of divergence between test results and known experience, judgement based on known experience shall take precedence over test results.

##### 2.5.2.1 Properties

2.5.2.1.1 Substances of class 5.1 in certain circumstances directly or indirectly evolve oxygen. For this reason, oxidizing substances increase the risk and intensity of fire in combustible material with which they come into contact.

2.5.2.1.2 Mixtures of oxidizing substances with combustible material and even with material such as sugar, flour, edible oils, mineral oils, etc., are dangerous. These mixtures are readily ignited, in some cases by friction or impact. They may burn violently and may lead to explosion.

2.5.2.1.3 There will be a violent reaction between most oxidizing substances and liquid acids, evolving toxic gases. Toxic gases may also be evolved when certain oxidizing substances are involved in a fire.

2.5.2.1.4 The above-mentioned properties are, in general, common to all substances in this class. Additionally, some substances possess specific properties, which shall be taken into account in transport. These properties are shown in the Dangerous Goods List in chapter 3.2.

## Part 2 – Classification

## 2.5.2.2 Oxidizing solids

## 2.5.2.2.1 Classification of solid substances of class 5.1

2.5.2.2.1.1 Tests are performed to measure the potential for the solid substance to increase the burning rate or burning intensity of a combustible substance when the two are thoroughly mixed. The procedure is given in the United Nations *Manual of Tests and Criteria*, part III, 34.4.1. Tests are conducted on the substance to be evaluated mixed with dry fibrous cellulose in mixing ratios of 1:1 and 4:1, by mass, of sample to cellulose. The burning characteristics of the mixtures are compared with the standard 3:7 mixture, by mass, of potassium bromate to cellulose. If the burning time is equal to or less than this standard mixture, the burning times shall be compared with those from the packing group I or II reference standards, 3:2 and 2:3 ratios, by mass, of potassium bromate to cellulose respectively.

2.5.2.2.1.2 The classification test results are assessed on the basis of:

- .1 the comparison of the mean burning time with those of the reference mixtures; and
- .2 whether the mixture of substance and cellulose ignites and burns.

2.5.2.2.1.3 A solid substance is classified in class 5.1 if the 4:1 or 1:1 sample-to-cellulose ratio (by mass) tested exhibits a mean burning time equal to or less than the mean burning time of a 3:7 mixture (by mass) of potassium bromate and cellulose.

## 2.5.2.2.2 Assignment of packing groups

2.5.2.2.2.1 Solid oxidizing substances are assigned to a packing group according to the test procedure in the United Nations *Manual of Tests and Criteria*, part III, 34.4.1, in accordance with the following criteria:

- .1 Packing group I: any substance which, in the 4:1 or 1:1 sample-to-cellulose ratio (by mass) tested, exhibits a mean burning time less than the mean burning time of a 3:2 mixture (by mass) of potassium bromate and cellulose;
- .2 Packing group II: any substance which, in the 4:1 or 1:1 sample-to-cellulose ratio (by mass) tested, exhibits a mean burning time equal to or less than the mean burning time of a 2:3 mixture (by mass) of potassium bromate and cellulose and the criteria for packing group I are not met;
- .3 Packing group III: any substance which, in the 4:1 or 1:1 sample-to-cellulose ratio (by mass) tested, exhibits a mean burning time equal to or less than the mean burning time of a 3:7 mixture (by mass) of potassium bromate and cellulose and the criteria for packing groups I and II are not met;
- .4 Not classified as class 5.1: any substance which, in both the 4:1 and 1:1 sample-to-cellulose ratio (by mass) tested, does not ignite and burn, or exhibits mean burning times greater than that of a 3:7 mixture (by mass) of potassium bromate and cellulose.

## 2.5.2.3 Oxidizing liquids

## 2.5.2.3.1 Classification of liquid substances of class 5.1

2.5.2.3.1.1 A test is performed to determine the potential for a liquid substance to increase the burning rate or burning intensity of a combustible substance or for spontaneous ignition to occur when the two are thoroughly mixed. The procedure is given in the United Nations *Manual of Tests and Criteria*, part III, 34.4.2. It measures the pressure rise time during combustion. Whether a liquid is an oxidizing substance of class 5.1 and, if so, whether packing group I, II or III shall be assigned, is decided on the basis of the test result (see also Precedence of hazard characteristics in 2.0.3).

2.5.2.3.1.2 The classification test results are assessed on the basis of:

- .1 whether the mixture of substance and cellulose spontaneously ignites;
- .2 the comparison of the mean time taken for the pressure to rise from 690 kPa to 2070 kPa gauge with those of the reference substances.

2.5.2.3.1.3 A liquid substance is classified in class 5.1 if the 1:1 mixture, by mass, of substance and cellulose tested exhibits a mean pressure rise time less than or equal to the mean pressure rise time of a 1:1 mixture, by mass, of 65% aqueous nitric acid and cellulose.

## 2.5.2.3.2 Assignment of packing groups

2.5.2.3.2.1 Liquid oxidizing substances are assigned to a packing group according to the test procedure in the United Nations *Manual of Tests and Criteria*, part III, 34.4.2, in accordance with the following criteria:

- .1 Packing group I: any substance which, in the 1:1 mixture (by mass) of substance and cellulose tested, spontaneously ignites; or the mean pressure rise time of a 1:1 mixture (by mass) of substance and cellulose is less than that of a 1:1 mixture (by mass) of 50% perchloric acid and cellulose;



- .2 Packing group II: any substance which, in the 1:1 mixture (by mass) of substance and cellulose tested, exhibits a mean pressure rise time less than or equal to the mean pressure rise time of a 1:1 mixture (by mass) of 40% aqueous sodium chlorate solution and cellulose; and the criteria for packing group I are not met;
- .3 Packing group III: any substance which, in the 1:1 mixture (by mass) of substance and cellulose tested, exhibits a mean pressure rise time less than or equal to the mean pressure rise time of a 1:1 mixture (by mass) of 65% aqueous nitric acid and cellulose; and the criteria for packing groups I and II are not met;
- .4 Not classified as class 5.1: any substance which, in the 1:1 mixture (by mass) of substance and cellulose tested, exhibits a pressure rise of less than 2070 kPa gauge; or exhibits a mean pressure rise time greater than the mean pressure rise time of a 1:1 mixture (by mass) of 65% aqueous nitric acid and cellulose.

### 2.5.3 Class 5.2 – Organic peroxides

#### 2.5.3.1 Properties

2.5.3.1.1 Organic peroxides are liable to exothermic decomposition at normal or elevated temperatures. The decomposition can be initiated by heat, contact with impurities (such as acids, heavy-metal compounds, amines), friction or impact. The rate of decomposition increases with temperature and varies with the organic peroxide formulation. Decomposition may result in the evolution of harmful, or flammable, gases or vapours. For certain organic peroxides the temperature shall be controlled during transport. Some organic peroxides may decompose explosively, particularly if confined. This characteristic may be modified by the addition of diluents or by the use of appropriate packagings. Many organic peroxides burn vigorously.

2.5.3.1.2 Contact of organic peroxides with the eyes is to be avoided. Some organic peroxides will cause serious injury to the cornea, even after brief contact, or will be corrosive to the skin.

#### 2.5.3.2 Classification of organic peroxides

2.5.3.2.1 Any organic peroxide shall be considered for classification in class 5.2, unless the organic peroxide formulation contains:

- .1 not more than 1.0% available oxygen from the organic peroxides when containing not more than 1.0% hydrogen peroxide; or
- .2 not more than 0.5% available oxygen from the organic peroxides when containing more than 1.0% but not more than 7.0% hydrogen peroxide.

**Note:** The available oxygen content (%) of an organic peroxide formulation is given by the formula:

$$16 \times \Sigma(n_i \times c_i / m_i)$$

where

$n_i$  = number of peroxygen groups per molecule of organic peroxide  $i$ ;

$c_i$  = concentration (mass %) of organic peroxide  $i$ ;

$m_i$  = molecular mass of organic peroxide  $i$ .

2.5.3.2.2 Organic peroxides are classified into seven types according to the degree of danger they present. The types of organic peroxide range from type A, which may not be accepted for transport in the packaging in which it is tested, to type G, which is not subject to the provisions for organic peroxides of class 5.2. The classification of types B to F is directly related to the maximum quantity allowed in one packaging.

2.5.3.2.3 Organic peroxides permitted for transport in packagings are listed in 2.5.3.2.4, those permitted for transport in IBCs are listed in packing instruction IBC520 and those permitted for transport in portable tanks are listed in portable tank instruction T23. For each permitted substance listed, the generic entry of the Dangerous Goods List (UN 3101 to UN 3120) is assigned, appropriate subsidiary risks and remarks providing relevant transport information are given. The generic entries specify:

- .1 organic peroxide type (B to F);
- .2 physical state (liquid or solid); and
- .3 temperature control, when required (see 2.5.3.4).

2.5.3.2.3.1 Mixtures of the listed formulations may be classified as the same type of organic peroxide as that of the most dangerous component and be transported under the conditions of transport given for this type. However, as two stable components can form a thermally less stable mixture, the self-accelerating decomposition temperature (SADT) of the mixture shall be determined and, if necessary, temperature control applied as required by 2.5.3.4.

Part 2 – Classification

2.5.3.2.4 List of currently assigned organic peroxides in packagings

Note: Packing Method codes “OP1” to “OP8” refer to packing methods in packing instruction P520. Peroxides to be transported shall fulfil the classification and the control and emergency temperatures (derived from the SADT) as listed. For substances permitted in IBCs, see packing instruction IBC520, and for those permitted in tanks, see portable tank instruction T23.

Number (generic entry)	ORGANIC PEROXIDE	Concentration (%)	Diluent type A (%)	Diluent type B (%) <sup>(1)</sup>	Inert solid (%)	Water (%)	Packing method	Control temperature (°C)	Emergency temperature (°C)	Subsidiary risks and remarks
3101	<i>tert</i> -BUTYL PEROXYACETATE	> 52 – 77	≥ 23				OP5			(3)
	1,1-Di-( <i>tert</i> -BUTYLPEROXY)CYCLOHEXANE	> 80 – 100					OP5			(3)
	1,1-Di-( <i>tert</i> -BUTYLPEROXY)-3,3,5-TRIMETHYLCYCLOHEXANE	> 90 – 100					OP5			(3)
	METHYL ETHYL KETONE PEROXIDE(S)	see remark (8)	≥ 48				OP5			(3) (8) (13)
	2,5-DIMETHYL-2,5-Di-( <i>tert</i> -BUTYLPEROXY)-HEXYNE-3	> 86 – 100					OP5			(3)
	<i>tert</i> -BUTYL MONOPEROXYMALEATE	> 52 – 100					OP5			(3)
	3-CHLOROPEROXYBENZOIC ACID	> 57 – 86			≥ 14		OP1			(3)
	DIBENZOYL PEROXIDE	> 51 – 100			≤ 48		OP2			(3)
	DIBENZOYL PEROXIDE	> 77 – 94				≥ 6	OP4			(3)
	Di-4-CHLOROBENZOYL PEROXIDE	≤ 77				≥ 23	OP5			(3)
Di-2,4-DICHLOROBENZOYL PEROXIDE	≤ 77				≥ 23	OP5			(3)	
2,2-DIHYDROPEROXYPROPANE	≤ 27					OP5			(3)	
2,5-DIMETHYL-2,5-Di-(BENZOYLPEROXY)HEXANE	> 82 – 100			≥ 73		OP5			(3)	
Di-( <i>o</i> -PHENOXYETHYL)PEROXYDICARBONATE	> 85 – 100					OP5			(3)	
DISUCCINIC ACID PEROXIDE	> 72 – 100					OP4			(3) (17)	
3103	<i>tert</i> -AMYL PEROXYBENZOATE	≤ 100					OP5			
	<i>tert</i> -AMYLPEROXY ISOPROPYL CARBONATE	≤ 77	≥ 23				OP5			
	<i>n</i> -BUTYL 4,4-Di-( <i>tert</i> -BUTYLPEROXY)VALERATE	> 52 – 100					OP5			
	<i>tert</i> -BUTYL HYDROPEROXIDE	> 79 – 90				≥ 10	OP5			(13)
	<i>tert</i> -BUTYL HYDROPEROXIDE + Di- <i>tert</i> -BUTYL PEROXIDE	< 82 + > 9				≥ 7	OP5			(13)
	<i>tert</i> -BUTYL MONOPEROXYMALEATE	≤ 52	≥ 48				OP6			
	<i>tert</i> -BUTYL PEROXYACETATE	> 32 – 52	≥ 48				OP6			
	<i>tert</i> -BUTYL PEROXYBENZOATE	> 77 – 100					OP5			
	<i>tert</i> -BUTYLPEROXY ISOPROPYLCARBONATE	≤ 77	≥ 23				OP5			
	<i>tert</i> -BUTYLPEROXY-2-METHYLBENZOATE	≤ 100					OP5			
1,1-Di-( <i>tert</i> -AMYLPEROXY)CYCLOHEXANE	≤ 82	≥ 18				OP6				

Chapter 2.5 – Class 5 – Oxidizing substances and organic peroxides

Number (generic entry)	ORGANIC PEROXIDE	Concentration (%)	Diluent type A (%)	Diluent type B (%) <sup>(1)</sup>	Inert solid (%)	Water (%)	Packing method	Control temperature (°C)	Emergency temperature (°C)	Subsidiary risks and remarks	
3103 (cont.)	2,2-Di-( <i>tert</i> -BUTYLPEROXY)BUTANE	≤ 52	≥ 48				OP6				
	1,6-Di-( <i>tert</i> -BUTYLPEROXYCARBONYLOXY)HEXANE	≤ 72	≥ 28				OP5				
	1,1-Di-( <i>tert</i> -BUTYLPEROXY)CYCLOHEXANE	> 52 – 80	≥ 20				OP5				
	1,1-Di-( <i>tert</i> -BUTYLPEROXY)CYCLOHEXANE	≤ 72	≥ 28	≥ 28			OP5			(30)	
	1,1-Di-( <i>tert</i> -BUTYLPEROXY)-3,3,5-TRIMETHYLCYCLOHEXANE	> 57 – 90	≥ 10				OP5				
	1,1-Di-( <i>tert</i> -BUTYLPEROXY)-3,3,5-TRIMETHYLCYCLOHEXANE	≤ 77	≥ 23	≥ 23			OP5				
	1,1-Di-( <i>tert</i> -BUTYLPEROXY)-3,3,5-TRIMETHYLCYCLOHEXANE	≤ 90	≥ 10	≥ 10			OP5			(30)	
	2,5-DIMETHYL-2,5-Di-( <i>tert</i> -BUTYLPEROXY)HEXANE	> 90 – 100					OP5				
	2,5-DIMETHYL-2,5-Di-( <i>tert</i> -BUTYLPEROXY)-HEXYNE-3	> 52 – 86	≥ 14				OP5			(26)	
	ETHYL 3,3-Di-( <i>tert</i> -BUTYLPEROXY)BUTYRATE	> 77 – 100					OP5				
	ORGANIC PEROXIDE, LIQUID, SAMPLE						OP2				(11)
	3104	CYCLOHEXANONE PEROXIDE(S)	≤ 91				≥ 9	OP6			(13)
DIBENZOYL PEROXIDE		≤ 77				≥ 23	OP6				
3105	2,5-DIMETHYL-2,5-Di(BENZOYLPEROXY)HEXANE	≤ 82				≥ 18	OP5				
	2,5-DIMETHYL-2,5-DIHYDROPEROXYHEXANE	≤ 82				≥ 18	OP6				
	ORGANIC PEROXIDE, SOLID, SAMPLE						OP2			(11)	
	ACETYL ACETONE PEROXIDE	≤ 42	≥ 48			≥ 8	OP7			(2)	
	<i>tert</i> -AMYL PEROXYACETATE	≤ 62	≥ 38				OP7				
	<i>tert</i> -AMYL PEROXY-2-ETHYLHEXYL CARBONATE	≤ 100					OP7				
	<i>tert</i> -AMYL PEROXY-3,5,5-TRIMETHYLHEXANOATE	≤ 100					OP7				
	<i>tert</i> -BUTYL HYDROPEROXIDE	≤ 80	≥ 20	≥ 20			OP7			(4) (13)	
	<i>tert</i> -BUTYL PEROXYBENZOATE	> 52 – 77	≥ 23	≥ 23			OP7				
	<i>tert</i> -BUTYL PEROXYBUTYL FUMARATE	≤ 52	≥ 48	≥ 48			OP7				
	<i>tert</i> -BUTYL PEROXYCROTONATE	≤ 77	≥ 23	≥ 23			OP7				
	<i>tert</i> -BUTYL PEROXY-2-ETHYLHEXYLCARBONATE	≤ 100					OP7				
1-(2- <i>tert</i> -BUTYLPEROXY ISOPROPYL)-3- <i>tert</i> -ISOPROPENYLBENZENE	≤ 77	≥ 23	≥ 23			OP7					
<i>tert</i> -BUTYL PEROXY-3,5,5-TRIMETHYLHEXANOATE	> 32 – 100					OP7					
CYCLOHEXANONE PEROXIDE(S)	≤ 72	≥ 28	≥ 28			OP7			(5)		

Part 2 – Classification

Number (generic entry)	ORGANIC PEROXIDE	Concentration (%)	Diluent type A (%)	Diluent type B (%) <sup>(1)</sup>	Inert solid (%)	Water (%)	Packing method	Control temperature (°C)	Emergency temperature (°C)	Subsidiary risks and remarks	
3105 (cont.)	2,2-Di-( <i>tert</i> -AMYLPEROXY)BUTANE	≤ 57	≥ 43				OP7				
	Di- <i>tert</i> -BUTYL PEROXYAZELATE	≤ 52	≥ 48				OP7				
	1,1-Di-( <i>tert</i> -BUTYLPEROXY)CYCLOHEXANE	> 42 – 52	≥ 48				OP7				
	1,1-Di-( <i>tert</i> -BUTYLPEROXY)CYCLOHEXANE + <i>tert</i> -BUTYL PEROXY-2-ETHYLHEXANOATE	≤ 43 + ≤ 16	≥ 41				OP7				
	Di-( <i>tert</i> -BUTYLPEROXY)PHTHALATE	> 42 – 52	≥ 48				OP7				
	2,2-Di-( <i>tert</i> -BUTYLPEROXY)PROPANE	≤ 52	≥ 48				OP7				
	2,5-DIMETHYL-2,5-Di-( <i>tert</i> -BUTYLPEROXY)HEXANE	> 52 – 90	≥ 10				OP7				
	2,5-DIMETHYL-2,5-Di-(3,5,5-TRIMETHYL-HEXANOYLPEROXY)HEXANE	≤ 77	≥ 23				OP7				
	ETHYL 3,3-Di-( <i>tert</i> -AMYLPEROXY)BUTYRATE	≤ 67	≥ 33				OP7				
	ETHYL 3,3-Di-( <i>tert</i> -BUTYLPEROXY)BUTYRATE	≤ 77	≥ 23				OP7			(13)	
	<i>p</i> -MENTHYL HYDROPEROXIDE	> 72 – 100					OP7				(9)
	METHYL ETHYL KETONE PEROXIDE(S)	see remark (9)	≥ 55				OP7				(22)
	METHYL ISOBUTYL KETONE PEROXIDE(S)	≤ 62	≥ 19				OP7				(13) (14) (19)
	PEROXYACETIC ACID, TYPE D, stabilized	≤ 43					OP7				(13)
PIANYL HYDROPEROXIDE	> 56 – 100					OP7				(28)	
1,1,3,3-TETRAMETHYLBUTYL HYDROPEROXIDE	≤ 100					OP7					
3,6,9-TRIETHYL-3,6,9-TRIMETHYL-1,4,7-TRIPEROXONANE	≤ 42	≥ 58				OP7				(20)	
3106	ACETYL ACETONE PEROXIDE	≤ 32 as a paste					OP7				
	<i>tert</i> -BUTYL PEROXYBENZOATE	≤ 52			≥ 48		OP7				
	<i>tert</i> -BUTYL PEROXY-2-ETHYLHEXANOATE + 2,2-Di-( <i>tert</i> -BUTYLPEROXY)BUTANE	≤ 12 + ≤ 14	≥ 14		≥ 60		OP7				
	<i>tert</i> -BUTYLPEROXY STEARYLCARBONATE	≤ 100					OP7				
	<i>tert</i> -BUTYL PEROXY-3,5,5-TRIMETHYLHEXANOATE	≤ 42			≥ 58		OP7				
	3-CHLOROPEROXYBENZOIC ACID	≤ 57			≥ 3	≥ 40	OP7				
	3-CHLOROPEROXYBENZOIC ACID	≤ 77			≥ 6	≥ 17	OP7				
	CYCLOHEXANONE PEROXIDE(S)	≤ 72 as a paste			≥ 28		OP7				(5) (20)
	DIBENZOYL PEROXIDE	≤ 62					OP7				(20)
	DIBENZOYL PEROXIDE	> 52 – 62 as a paste				≥ 48		OP7			
DIBENZOYL PEROXIDE	> 35 – 52						OP7				

Chapter 2.5 – Class 5 – Oxidizing substances and organic peroxides

Number (generic entry)	ORGANIC PEROXIDE	Concentration (%)	Diluent type A (%)	Diluent type B (%) <sup>(1)</sup>	Inert solid (%)	Water (%)	Packing method	Control temperature (°C)	Emergency temperature (°C)	Subsidiary risks and remarks
3106 (cont.)	1,1-DI-( <i>tert</i> -BUTYLPEROXY)CYCLOHEXANE	≤ 42	≥ 13		≥ 45		OP7			
	DI-( <i>tert</i> -BUTYLPEROXYISOPROPYL)BENZENE(S)	> 42 – 100			≤ 57		OP7			(20)
	DI-( <i>tert</i> -BUTYLPEROXY)PHTHALATE	≤ 52 as a paste					OP7			(20)
	2,2-DI-( <i>tert</i> -BUTYLPEROXY)PROPANE	≤ 42	≥ 13		≥ 45		OP7			(20)
	DI-4-CHLOROBENZOYL PEROXIDE	≤ 52 as a paste			≥ 58		OP7			
	2,2-DI-(4,4-DI-( <i>tert</i> -BUTYLPEROXY)CYCLOHEXYL)-PROPANE	≤ 42					OP7			
	DI-2,4-DICHLOROBENZOYL PEROXIDE	≤ 52 as a paste with silicon oil					OP7			
	DI-(1-HYDROXYCYCLOHEXYL)PEROXIDE	≤ 100					OP7			
	DIISOPROPYLBENZENE DIHYDROPEROXIDE	≤ 82	≥ 5		≥ 5		OP7			(24)
	DILAULOYL PEROXIDE	≤ 100					OP7			
	DI-(4-METHYLBENZOYL) PEROXIDE	≤ 52 as paste with silicon oil					OP7			
	2,5-DIMETHYL-2,5-DI-(BENZOYLPEROXY)HEXANE	≤ 82			≥ 18		OP7			
2,5-DIMETHYL-2,5-DI-( <i>tert</i> -BUTYLPEROXY)-HEXYNE-3	≤ 52			≥ 48		OP7				
3107	DI-(2-PHENOXYETHYL)PEROXYDICARBONATE	≤ 85			≥ 15		OP7			
	ETHYL 3,3-DI-( <i>tert</i> -BUTYLPEROXY)BUTYRATE	≤ 52					OP7			
	((3R-3R,5aS,6S,8aS,9R,10R,12S,12aR*))-DECAHYDRO-10-METHOXY-3,6,9-TRIMETHYL-3,12-EPOXY-12H-PYRANO[4,3- <i>ij</i> ]-1,2-BENZODIOXEPIN)	≤ 100			≥ 48		OP7			
	<i>tert</i> -AMYL HYDROPEROXIDE	≤ 88	≥ 6			≥ 6	OP8			
	<i>tert</i> -BUTYL CUMYL PEROXIDE	> 42 – 100					OP8			
	<i>tert</i> -BUTYL HYDROPEROXIDE	≤ 79				> 14	OP8			(13) (23)
	CUMYL HYDROPEROXIDE	> 90 – 98	≤ 10				OP8			(13)
	DI- <i>tert</i> -AMYL PEROXIDE	≤ 100					OP8			
	DIBENZOYL PEROXIDE	> 36 – 42	≥ 18			≤ 40	OP8			
	DI-( <i>tert</i> -BUTYL PEROXIDE	> 52 – 100					OP8			
	1,1-DI-( <i>tert</i> -BUTYLPEROXY)CYCLOHEXANE	≤ 27	≥ 25				OP8			(21)
	DI-( <i>tert</i> -BUTYLPEROXY)PHTHALATE	≤ 42	≥ 58				OP8			
1,1-DI-( <i>tert</i> -BUTYLPEROXY)-3,5-TRIMETHYL-CYCLOHEXANE	≤ 57	≥ 43				OP8				

Part 2 – Classification

Number (generic entry)	ORGANIC PEROXIDE	Concentration (%)	Diluent type A (%)	Diluent type B (%) <sup>(1)</sup>	Inert solid (%)	Water (%)	Packing method	Control temperature (°C)	Emergency temperature (°C)	Subsidiary risks and remarks
3107 (cont.)	1,1-DI-( <i>tert</i> -BUTYLPEROXY)-3,3,5-TRIMETHYLCYCLOHEXANE	≤ 32	≥ 26	≥ 42			OP8			
	2,2-DI-(4,4-DI-( <i>tert</i> -BUTYLPEROXY)CYCLOHEXYL)-PROPANE	≤ 22		≥ 78			OP8			
	METHYL ETHYL KETONE PEROXIDE(S)	see remark (10)	≥ 60				OP8			(10)
	3,3,5,7,7-PENTAMETHYL-1,2,4-TRIOXEPANE	≤ 100					OP8			(13) (15) (19)
	PEROXYACETIC ACID, TYPE E, stabilized	≤ 43					OP8			
	POLYETHER POLY-( <i>tert</i> -BUTYLPEROXY-CARBONATE	≤ 52		≥ 48			OP8			
	<i>tert</i> -BUTYL CUMYL PEROXIDE	≤ 52			≥ 48		OP8			
	<i>n</i> -BUTYL 4,4-DI-( <i>tert</i> -BUTYLPEROXY)VALERATE	≤ 52			≥ 48		OP8			
	<i>tert</i> -BUTYL MONOPEROXYMALEATE	≤ 52			≥ 48		OP8			
	<i>tert</i> -BUTYL MONOPEROXYMALEATE	≤ 52 as a paste					OP8			
3108	1-(2- <i>tert</i> -BUTYLPEROXYISOPROPYL)-3-ISOPROPENYLBENZENE	≤ 42			≥ 58		OP8			
	DIBENZOYL PEROXIDE	≤ 56.5 as a paste				≥ 15	OP8			
	DIBENZOYL PEROXIDE	≤ 52 as a paste					OP8			(20)
	2,5-DIMETHYL-2,5-DI-( <i>tert</i> -BUTYLPEROXY)HEXANE	≤ 47 as a paste					OP8			
	2,5-DIMETHYL-2,5-DI-( <i>tert</i> -BUTYLPEROXY)HEXANE	≤ 77			≥ 23		OP8			
	<i>tert</i> -BUTYL HYDROPEROXIDE	≤ 72				≥ 28	OP8			(13)
	<i>tert</i> -BUTYL PEROXYACETATE	≤ 32			≥ 68		OP8			
	<i>tert</i> -BUTYL PEROXY-3,5,5-TRIMETHYL-HEXANOATE	≤ 32			≥ 68		OP8			
	CUMYL HYDROPEROXIDE	≤ 90	≥ 10				OP8			(13) (18)
	DIBENZOYL PEROXIDE	≤ 42 as a stable dispersion in water					OP8			
3109	DI- <i>tert</i> -BUTYL PEROXIDE	≤ 52		≥ 48			OP8			(25)
	1,1-DI-( <i>tert</i> -BUTYLPEROXY)CYCLOHEXANE	≤ 42	≥ 58				OP8			
	1,1-DI-( <i>tert</i> -BUTYLPEROXY)CYCLOHEXANE	≤ 13	≥ 13	≥ 74			OP8			
	DILAULOYL PEROXIDE	≤ 42 as a stable dispersion in water					OP8			
	2,5-DIMETHYL-2,5-DI-( <i>tert</i> -BUTYLPEROXY)HEXANE	≤ 52	≥ 48				OP8			
	ISOPROPYLCUMYL HYDROPEROXIDE	≤ 72	≥ 28				OP8			(13)
	<i>p</i> -MENTHYL HYDROPEROXIDE	≤ 72	≥ 28				OP8			(27)
	METHYL ISOPROPYL KETONE PEROXIDE(S)	See remark (31)	≥ 70				OP8			(31)
	PEROXYACETIC ACID, TYPE F, stabilized	≤ 43					OP8			(13) (16) (19)

Chapter 2.5 – Class 5 – Oxidizing substances and organic peroxides

Number (generic entry)	ORGANIC PEROXIDE	Concentration (%)	Diluent type A (%)	Diluent type B (%) <sup>(1)</sup>	Inert solid (%)	Water (%)	Packing method	Control temperature (°C)	Emergency temperature (°C)	Subsidiary risks and remarks
3109 (cont.)	PINANYL HYDROPEROXIDE	≤ 56	≥ 44				OP8			
3110	DICUMYL PEROXIDE	> 52 – 100					OP8			(12)
	1,1-DI-( <i>tert</i> -BUTYLPEROXY)-3,3,5-TRIMETHYLCYCLOHEXANE	≤ 57			≥ 43		OP8			
	3,6,9-TRIMETHYL-3,6,9-TRIMETHYL-1,4,7-TRIPEROXONANE	≤ 17	≥ 18		≥ 65		OP8			
3111	<i>tert</i> -BUTYL PEROXYISOBUTYRATE	> 52 – 77		≥ 23			OP5	+15	+20	(3)
	DIISOBUTYRYL PEROXIDE	> 32 – 52		≥ 48			OP5	-20	-10	(3)
	ISOPROPYL <i>sec</i> -BUTYL PEROXYDICARBONATE + DI- <i>sec</i> -BUTYL PEROXYDICARBONATE + DIISOPROPYL PEROXYDICARBONATE	≤ 52 + ≤ 28 + ≤ 22					OP5	-20	-10	(3)
	ACETYL CYCLOHEXANESULPHONYL PEROXIDE	≤ 82				≥ 12	OP4	-10	0	(3)
3112	DICYCLOHEXYL PEROXYDICARBONATE	> 91 – 100					OP3	+10	+15	(3)
	DIISOPROPYL PEROXYDICARBONATE	> 52 – 100					OP2	-15	-5	(3)
	DI-(2-METHYLBENZOYL) PEROXIDE	≤ 87				≥ 13	OP5	+30	+35	(3)
	<i>tert</i> -AMYL PEROXYPIVALATE	≤ 77		≥ 23			OP5	+10	+15	
3113	<i>tert</i> -BUTYL PEROXYDIETHYLACETATE	≤ 100					OP5	+20	+25	
	<i>tert</i> -BUTYL PEROXY-2-ETHYLHEXANOATE	> 52 – 100					OP6	+20	+25	
	<i>tert</i> -BUTYL PEROXYPIVALATE	> 67 – 77	≥ 23				OP5	0	+10	
	DI- <i>sec</i> -BUTYL PEROXYDICARBONATE	> 52 – 100					OP4	-20	-10	
	DI-(2-ETHYLHEXYL)PEROXYDICARBONATE	> 77 – 100					OP5	-20	-10	
	2,5-DIMETHYL-2,5-DI-(2-ETHYLHEXANOYLPEROXY)-HEXANE	≤ 100					OP5	+20	+25	
	DI- <i>n</i> -PROPYL PEROXYDICARBONATE	≤ 100					OP3	-25	-15	
3114	DI- <i>n</i> -PROPYL PEROXYDICARBONATE	≤ 77		≥ 23			OP5	-20	-10	(11)
	ORGANIC PEROXIDE LIQUID, SAMPLE, TEMPERATURE CONTROLLED						OP2			
	DI-(4- <i>tert</i> -BUTYL)CYCLOHEXYL-PEROXYDICARBONATE	≤ 100					OP6	+30	+35	
	DICYCLOHEXYL PEROXYDICARBONATE	≤ 91				≥ 9	OP5	+10	+15	
3115	DIDECANOYL PEROXIDE	≤ 100					OP6	+30	+35	
	DI- <i>n</i> -OCTANOYL PEROXIDE	≤ 100					OP5	+10	+15	
	ORGANIC PEROXIDE, SOLID, SAMPLE, TEMPERATURE CONTROLLED						OP2			(11)
	ACETYL CYCLOHEXANESULPHONYL PEROXIDE	≤ 32		≥ 68			OP7	-10	0	

Part 2 – Classification

Number (generic entry)	ORGANIC PEROXIDE	Concentration (%)	Diluent type A (%)	Diluent type B (%) <sup>(1)</sup>	Inert solid (%)	Water (%)	Packing method	Control temperature (°C)	Emergency temperature (°C)	Subsidiary risks and remarks
3115 (cont.)	<i>tert</i> -AMYL PEROXY-2-ETHYLHEXANOATE	≤ 100					OP7	+20	+25	
	<i>tert</i> -AMYL PEROXYNEODECANOATE	≤ 77		≥ 23			OP7	0	+10	
	<i>tert</i> -BUTYL PEROXY-2-ETHYLHEXANOATE + 2,2-DI-( <i>tert</i> -BUTYLPEROXY)BUTANE	≤ 31 + ≤ 36		≥ 33			OP7	+35	+40	
	<i>tert</i> -BUTYL PEROXYISOBUTYRATE	≤ 52		≥ 48			OP7	+15	+20	
	<i>tert</i> -BUTYL PEROXYNEODECANOATE	> 77 – 100					OP7	-5	+5	
	<i>tert</i> -BUTYL PEROXYNEODECANOATE	≤ 77		≥ 23			OP7	0	+10	
	<i>tert</i> -BUTYL PEROXYNEOHEPTANOATE	≤ 77	≥ 23				OP7	0	+10	
	<i>tert</i> -BUTYL PEROXYPIVALATE	> 27 – 67		≥ 33			OP7	0	+10	
	CUMYL PEROXYNEODECANOATE	≤ 77		≥ 23			OP7	-10	0	
	CUMYL PEROXYNEODECANOATE	≤ 87	≥ 13				OP7	-10	0	
	CUMYL PEROXYNEOHEPTANOATE	≤ 77	≥ 23				OP7	-10	0	
	CUMYL PEROXYPIVALATE	≤ 77		≥ 23			OP7	-5	+5	
	DIACETONE ALCOHOL PEROXIDES	≤ 57		≥ 26			OP7	+40	+45	(6)
	DIACETYL PEROXIDE	≤ 27		≥ 73		≥ 8	OP7	+20	+25	(7) (13)
	DI- <i>n</i> -BUTYL PEROXYDICARBONATE	> 27 – 52		≥ 48			OP7	-15	-5	
	DI- <i>sec</i> -BUTYL PEROXYDICARBONATE	≤ 52		≥ 48			OP7	-15	-5	
	DI-(2-ETHOXYETHYL)PEROXYDICARBONATE	≤ 52		≥ 48			OP7	-10	0	
	DI-(2-ETHYLHEXYL)PEROXYDICARBONATE	≤ 77		≥ 23			OP7	-15	-5	
	DIISOBUTYRYL PEROXIDE	≤ 32		≥ 68			OP7	-20	-10	
DIISOPROPYL PEROXYDICARBONATE	≤ 52		≥ 48			OP7	-20	-10		
DIISOPROPYL PEROXYDICARBONATE	≤ 32		≥ 68			OP7	-15	-5		
DI-(3-METHOXYBUTYL) PEROXYDICARBONATE	≤ 52		≥ 48			OP7	-5	+5		
DI-(3-METHYLBENZOYL) PEROXIDE + BENZOYL (3-METHYLBENZOYL) PEROXIDE + DIBENZOYL PEROXIDE	≤ 20 + ≤ 18 + ≤ 4		≥ 58			OP7	+35	+40		
DI-(2-NEODECANOYL)PEROXYISOPROPYL)-BENZENE	≤ 52	≥ 48				OP7	-10	0		
DI-(3,5,5-TRIMETHYLHEXANOYL) PEROXIDE	> 52 – 82	≥ 18				OP7	0	+10		
1-(2-ETHYLHEXANOYL)PEROXY)-1,3-DIMETHYLBUTYL PEROXYPIVALATE	≤ 52	≥ 45		≥ 10		OP7	-20	-10		
<i>tert</i> -HEXYL PEROXYNEODECANOATE	≤ 71	≥ 29				OP7	0	+10		
<i>tert</i> -HEXYL PEROXYPIVALATE	≤ 72		≥ 28			OP7	+10	+15		



Chapter 2.5 – Class 5 – Oxidizing substances and organic peroxides

Number (generic entry)	ORGANIC PEROXIDE	Concentration (%)	Diluent type A (%)	Diluent type B (%) <sup>(1)</sup>	Inert solid (%)	Water (%)	Packing method	Control temperature (°C)	Emergency temperature (°C)	Subsidiary risks and remarks
3115 (cont.)	3-HYDROXY-1,1-DIMETHYLBUTYL PEROXYNEODECANOATE	≤ 77	≥ 23				OP7	-5	+5	
	ISOPROPYL <i>sec</i> -BUTYL PEROXYDICARBONATE + DI- <i>sec</i> -BUTYL PEROXYDICARBONATE + DI-ISOPROPYL PEROXYDICARBONATE	≤ 32 + ≤ 15 - 18 + ≤ 12 - 15	≥ 38				OP7	-20	-10	
	METHYLCYCLOHEXANONE PEROXIDE(S)	≤ 67	≥ 33				OP7	+35	+40	
	1,1,3,3-TETRAMETHYLBUTYL PEROXY-2-ETHYLHEXANOATE	≤ 100					OP7	+15	+20	
	1,1,3,3-TETRAMETHYLBUTYL PEROXY-NEODECANOATE	≤ 72		≥ 28			OP7	-5	+5	
	1,1,3,3-TETRAMETHYLBUTYL PEROXYPIVALATE	≤ 77	≥ 23				OP7	0	+10	
	DICETYL PEROXYDICARBONATE	≤ 100					OP7	+30	+35	
	DIMYRISTYL PEROXYDICARBONATE	≤ 100					OP7	+20	+25	
	DI- <i>n</i> -NONANOYL PEROXIDE	≤ 100					OP7	0	+10	
	DISUCCINIC ACID PEROXIDE	≤ 72				≥ 28	OP7	+10	+15	
3117	<i>tert</i> -BUTYL PEROXY-2-ETHYLHEXANOATE	> 32 - 52		≥ 48			OP8	+30	+35	
	DI- <i>n</i> -BUTYL PEROXYDICARBONATE	≤ 27		≥ 73			OP8	-10	0	
	<i>tert</i> -BUTYL PEROXYNEOHEPTANOATE	≤ 42 as a stable dispersion in water					OP8	0	+10	
	1,1-DIMETHYL-3-HYDROXYBUTYL PEROXY-NEOHEPTANOATE	≤ 52	≥ 48				OP8	0	+10	
	DIPROPIONYL PEROXIDE	≤ 27		≥ 73			OP8	+15	+20	
	3-HYDROXY-1,1-DIMETHYLBUTYL PEROXY-NEODECANOATE	≤ 52	≥ 48				OP8	-5	+5	
	<i>tert</i> -BUTYL PEROXY-2-ETHYLHEXANOATE	≤ 52			≥ 48		OP8	+20	+25	
	<i>tert</i> -BUTYL PEROXYNEODECANOATE	< 42 as a stable dispersion in water (frozen)					OP8	0	+10	
3118	DI- <i>n</i> -BUTYL PEROXYDICARBONATE	≤ 42 as a stable dispersion in water (frozen)					OP8	-15	-5	
	DI-2,4-DICHLOROBENZOYL PEROXIDE	≤ 52 as a paste					OP8	+20	+25	
	PEROXYLAURIC ACID	≤ 100					OP8	+35	+40	
	<i>tert</i> -AMYL PEROXYNEODECANOATE	≤ 47	≥ 63				OP8	0	+10	
3119	<i>tert</i> -BUTYL PEROXY-2-ETHYLHEXANOATE	≤ 32		≥ 68			OP8	+40	+45	
	<i>tert</i> -BUTYL PEROXYNEODECANOATE	≤ 52 as a stable dispersion in water					OP8	0	+10	

Part 2 – Classification

Number (generic entry)	ORGANIC PEROXIDE	Concentration (%)	Diluent type A (%)	Diluent type B (%) <sup>(1)</sup>	Inert solid (%)	Water (%)	Packing method	Control temperature (°C)	Emergency temperature (°C)	Subsidiary risks and remarks
3119 (cont.)	<i>tert</i> -BUTYL PEROXYNEODECANOATE	≤ 32	≥ 68				OP8	0	+10	
	<i>tert</i> -BUTYL PEROXYPIVALATE	≤ 27		≥ 73			OP8	+30	+35	
	CUMYL PEROXYNEODECANOATE	≤ 52 as a stable dispersion in water					OP8	-10	0	
	Di-(4- <i>tert</i> -BUTYL-CYCLOHEXYL) PEROXYDICARBONATE	≤ 42 as a stable dispersion in water					OP8	+30	+35	
	DICETYL PEROXYDICARBONATE	≤ 42 as a stable dispersion in water					OP8	+30	+35	
	DICYCLOHEXYL PEROXYDICARBONATE	≤ 42 as a stable dispersion in water					OP8	+15	+20	
	Di-(2-ETHYLHEXYL) PEROXYDICARBONATE	≤ 62 as a stable dispersion in water					OP8	-15	-5	
	DIMYRISTYL PEROXYDICARBONATE	≤ 42 as a stable dispersion in water					OP8	+20	+25	
	Di-(3,5,5-TRIMETHYLHEXANOYL) PEROXIDE	≤ 52 as a stable dispersion in water					OP8	+10	+15	
	Di-(3,5,5-TRIMETHYLHEXANOYL) PEROXIDE	≤ 38	≥ 62				OP8	+20	+25	
	Di-(3,5,5-TRIMETHYLHEXANOYL) PEROXIDE	> 38 – 52	≥ 48				OP8	+10	+15	
	3-HYDROXY-1,1-DIMETHYLBUTYL PEROXYNEODECANOATE	≤ 52 as a stable dispersion in water					OP 8	-5	+ 5	
3120	1,1,3,3-TETRAMETHYLBUTYL PEROXYNEODECANOATE	≤ 52 as a stable dispersion in water					OP8	-5	+ 5	
	Di-(2-ETHYLHEXYL)PEROXYDICARBONATE	≤ 52 as a stable dispersion in water (frozen)					OP8	-15	-5	
	EXEMPT	CYCLOHEXANONE PEROXIDE(S)	≤ 32		≥ 68					(29)
	EXEMPT	DIBENZOYL PEROXIDE	≤ 35		≥ 65					(29)
	EXEMPT	Di-(2- <i>tert</i> -BUTYL)PEROXYISOPROPYL)BENZENE(S)	≤ 42		≥ 58					(29)
EXEMPT	Di-4-CHLOROBENZOYL PEROXIDE	≤ 32		≥ 68					(29)	
EXEMPT	DICUMYL PEROXIDE	≤ 52		≥ 48					(29)	

- (1) Diluent type B may always be replaced by diluent type A. The boiling point of diluent type B shall be at least 60°C higher than the SADT of the organic peroxide
- (2) Available oxygen  $\leq$  4.7%
- (3) "EXPLOSIVE" subsidiary risk label required. (Model No. 1, see 5.2.2.2.2)
- (4) Diluent may be replaced by di-*tert*-butyl peroxide
- (5) Available oxygen  $\leq$  9%
- (6) With  $\leq$  9% hydrogen peroxide; available oxygen  $\leq$  10%
- (7) Only non-metallic packagings are allowed
- (8) Available oxygen  $>$  10% and  $\leq$  10.7%, with or without water
- (9) Available oxygen  $\leq$  10%, with or without water
- (10) Available oxygen  $\leq$  8.2%, with or without water
- (11) See 2.5.3.2.5.1
- (12) Up to 2000 kg per receptacle assigned to ORGANIC PEROXIDE TYPE F on the basis of large-scale trials
- (13) "CORROSIVE" subsidiary risk label required (Model No. 8, see 5.2.2.2.2)
- (14) Peroxyacetic acid formulations which fulfil the criteria of 2.5.3.3.2.4
- (15) Peroxyacetic acid formulations which fulfil the criteria of 2.5.3.3.2.5
- (16) Peroxyacetic acid formulations which fulfil the criteria of 2.5.3.3.2.6
- (17) Addition of water to this organic peroxide will decrease its thermal stability
- (18) No "CORROSIVE" subsidiary risk label required for concentrations below 80%
- (19) Mixtures with hydrogen peroxide, water and acid(s)
- (20) With diluent type A, with or without water
- (21) With  $\geq$  25% diluent type A by mass, and in addition ethylbenzene
- (22) With  $\geq$  19% diluent type A by mass, and in addition methyl isobutyl ketone
- (23) With  $<$  6% di-*tert*-butyl peroxide
- (24) With  $\leq$  8% 1-isopropylhydroperoxy-4-isopropylhydroxybenzene
- (25) Diluent type B with boiling point  $>$  110°C
- (26) With  $<$  0.5% hydroperoxides content
- (27) For concentrations more than 56%, "CORROSIVE" subsidiary risk label required (Model No. 8, see 5.2.2.2.2)
- (28) Available active oxygen  $\leq$  7.6% in diluent type A having a 95% boil-off point in the range 200–260°C
- (29) Not subject to the provisions for peroxide, class 5.2
- (30) Diluent type B with boiling point  $>$  130°C
- (31) Active oxygen  $\leq$  6.7%

**2.5.3.2.5** Classification of organic peroxides not listed in 2.5.3.2.4, packing instruction IBC520 or portable tank instruction T23 and assignment to a generic entry shall be made by the competent authority of the country of origin on the basis of a test report. Principles applying to the classification of such substances are provided in 2.5.3.3. Test methods and criteria and an example of a report are given in the current edition of the United Nations *Manual of Tests and Criteria*, part II. The statement of approval shall contain the classification and the relevant transport conditions (see 5.4.4.1.3).

**2.5.3.2.5.1** Samples of new organic peroxides or new formulations of currently assigned organic peroxides for which complete test data are not available and which are to be transported for further testing or evaluation may be assigned to one of the appropriate entries for ORGANIC PEROXIDE TYPE C provided the following conditions are met:

- .1 the available data indicate that the sample would be no more dangerous than ORGANIC PEROXIDE TYPE B;
- .2 the sample is packaged in accordance with packing method OP2 and the quantity per cargo transport unit is limited to 10 kg; and
- .3 the available data indicate that the control temperature, if any, is sufficiently low to prevent any dangerous decomposition and sufficiently high to prevent any dangerous phase separation.

### 2.5.3.3 Principles for classification of organic peroxides

**Note:** This section refers only to those properties of organic peroxides which are decisive for their classification. A flow chart, presenting the classification principles in the form of a graphically arranged scheme of questions concerning the decisive properties together with the possible answers, is given in Figure 2.5.1 in chapter 2.5 of the United Nations *Recommendations on the Transport of Dangerous Goods*. These properties shall be determined experimentally. Suitable test methods with pertinent evaluation criteria are given in the United Nations *Manual of Tests and Criteria*, part II.

**2.5.3.3.1** Any organic peroxide formulation shall be regarded as possessing explosive properties when, in laboratory testing, the formulation is liable to detonate, to deflagrate rapidly or to show a violent effect when heated under confinement.

Part 2 – Classification

---

- 2.5.3.3.2 The following principles apply to the classification of organic peroxide formulations not listed in 2.5.3.2.4:
- .1 Any organic peroxide formulation which can detonate or deflagrate rapidly, as packaged for transport, is prohibited from transport in that packaging under class 5.2 (defined as ORGANIC PEROXIDE TYPE A);
  - .2 Any organic peroxide formulation possessing explosive properties and which, as packaged for transport, neither detonates nor deflagrates rapidly, but is liable to undergo a thermal explosion in that package, shall bear an “EXPLOSIVE” subsidiary risk label (Model No. 1, see 5.2.2.2.2). Such an organic peroxide may be packaged in amounts of up to 25 kg unless the maximum quantity has to be limited to a lower amount to preclude detonation or rapid deflagration in the package (defined as ORGANIC PEROXIDE TYPE B);
  - .3 Any organic peroxide formulation possessing explosive properties may be transported without an “EXPLOSIVE” subsidiary risk label when the substance as packaged (maximum 50 kg) for transport cannot detonate or deflagrate rapidly or undergo a thermal explosion (defined as ORGANIC PEROXIDE TYPE C);
  - .4 Any organic peroxide formulation which, in laboratory testing:
    - .1 detonates partially, does not deflagrate rapidly and shows no violent effect when heated under confinement; or
    - .2 does not detonate at all, deflagrates slowly and shows no violent effect when heated under confinement; or
    - .3 does not detonate or deflagrate at all and shows a medium effect when heated under confinement is acceptable for transport in packages of not more than 50 kg net mass (defined as ORGANIC PEROXIDE TYPE D);
  - .5 Any organic peroxide formulation which, in laboratory testing, neither detonates nor deflagrates at all and shows low or no effect when heated under confinement is acceptable for transport in packages of not more than 400 kg/450 l (defined as ORGANIC PEROXIDE TYPE E);
  - .6 Any organic peroxide formulation which, in laboratory testing, neither detonates in the cavitated state nor deflagrates at all and shows only a low or no effect when heated under confinement as well as low or no explosive power may be considered for transport in IBCs or tanks (defined as ORGANIC PEROXIDE TYPE F); for additional provisions see 4.1.7 and 4.2.1.13;
  - .7 Any organic peroxide formulation which, in laboratory testing, neither detonates in the cavitated state nor deflagrates at all and shows no effect when heated under confinement nor any explosive power shall be exempted from class 5.2, provided that the formulation is thermally stable (self-accelerating decomposition temperature is 60°C or higher for a 50 kg package) and for liquid formulations diluent type A is used for desensitization (defined as ORGANIC PEROXIDE TYPE G). If the formulation is not thermally stable or a diluent other than type A is used for desensitization, the formulation shall be defined as ORGANIC PEROXIDE TYPE F.
- 2.5.3.4 **Temperature control provisions**
- 2.5.3.4.0 The properties of some organic peroxides require that they be transported under temperature control. Control and emergency temperatures for currently assigned organic peroxides are shown in the list 2.5.3.2.4. The controlled temperature provisions are given in chapter 7.3.7.
- 2.5.3.4.1 The following organic peroxides shall be subjected to temperature control during transport:
- .1 organic peroxides type B and C with a SADT  $\leq 50^{\circ}\text{C}$ ;
  - .2 organic peroxides type D showing a medium effect when heated under confinement\* with a SADT  $\leq 50^{\circ}\text{C}$  or showing a low or no effect when heated under confinement with a SADT  $\leq 45^{\circ}\text{C}$ ; and
  - .3 organic peroxides types E and F with a SADT  $\leq 45^{\circ}\text{C}$ .
- 2.5.3.4.2 Test methods for determining the SADT are given in the United Nations *Manual of Tests and Criteria*, part II, chapter 28. The test selected shall be conducted in a manner which is representative, both in size and material, of the package to be transported.
- 2.5.3.4.3 Test methods for determining the flammability are given in the United Nations *Manual of Tests and Criteria*, part III, chapter 32.4. Because organic peroxides may react vigorously when heated, it is recommended to determine their flashpoint using small sample sizes such as described in ISO 3679.
- 2.5.3.5 **Desensitization of organic peroxides**
- 2.5.3.5.1 In order to ensure safety during transport, organic peroxides are in many cases desensitized by organic liquids or solids, inorganic solids or water. Where a percentage of a substance is stipulated, this refers to the percentage by mass, rounded to the nearest whole number. In general, desensitization shall be such that, in case of spillage or fire, the organic peroxide will not concentrate to a dangerous extent.

---

\* As determined by test series E as prescribed in the United Nations *Manual of Tests and Criteria*, part II.

- 2.5.3.5.2** Unless otherwise stated for the individual organic peroxide formulation, the following definitions apply for diluents used for desensitization:
- .1** Diluents type A are organic liquids which are compatible with the organic peroxide and which have a boiling point of not less than 150°C. Type A diluents may be used for desensitizing all organic peroxides.
  - .2** Diluents type B are organic liquids which are compatible with the organic peroxide and which have a boiling point of less than 150°C but not less than 60°C and a flashpoint of not less than 5°C. Type B diluents may be used for desensitization of all organic peroxides provided that the boiling point is at least 60°C higher than the SADT in a 50 kg package.
- 2.5.3.5.3** Diluents, other than type A or type B, may be added to organic peroxide formulations as listed in 2.5.3.2.4 provided that they are compatible. However, replacement of all or part of a type A or type B diluent by another diluent with differing properties requires that the organic peroxide formulation be re-assessed in accordance with the normal acceptance procedure for class 5.2.
- 2.5.3.5.4** Water may only be used for the desensitization of organic peroxides which are shown in 2.5.3.2.4 or in the statement of approval according to 2.5.3.2.5 as being with water or as a stable dispersion in water.
- 2.5.3.5.5** Organic and inorganic solids may be used for desensitization of organic peroxides provided that they are compatible.
- 2.5.3.5.6** Compatible liquids and solids are those which have no detrimental influence on the thermal stability and hazard type of the organic peroxide formulation.

## Chapter 2.6

---

### Class 6 – Toxic and infectious substances

#### 2.6.0 Introductory notes

- Note 1:** The word “toxic” has the same meaning as “poisonous”.
- Note 2:** Genetically modified microorganisms which do not meet the definition of a toxic or an infectious substance shall be considered for classification in class 9 and assigned to UN 3245.
- Note 3:** Toxins from plant, animal or bacterial sources which do not contain any infectious substances, or toxins that are contained in substances which are not infectious substances, shall be considered for classification in class 6.1 and assigned to UN 3172.

#### 2.6.1 Definitions

Class 6 is subdivided into two classes as follows:

##### Class 6.1 – Toxic substances

These are substances liable either to cause death or serious injury or to harm human health if swallowed or inhaled, or by skin contact.

##### Class 6.2 – Infectious substances

These are substances known or reasonably expected to contain pathogens. Pathogens are defined as microorganisms (including bacteria, viruses, rickettsiae, parasites, fungi) and other agents such as prions, which can cause disease in humans or animals.

#### 2.6.2 Class 6.1 – Toxic substances

##### 2.6.2.1 Definitions and properties

- 2.6.2.1.1** *LD<sub>50</sub> (median lethal dose) for acute oral toxicity* is the statistically derived single dose of a substance that can be expected to cause death within 14 days in 50 per cent of young adult albino rats when administered by the oral route. The *LD<sub>50</sub>* value is expressed in terms of mass of test substance per mass of test animal (mg/kg).
- 2.6.2.1.2** *LD<sub>50</sub> for acute dermal toxicity* is that dose of the substance which, administered by continuous contact for 24 hours with the bare skin of the albino rabbit, is most likely to cause death within 14 days in one half of the animals tested. The number of animals tested shall be sufficient to give a statistically significant result and be in conformity with good pharmacological practices. The result is expressed in milligrams per kilogram body mass.
- 2.6.2.1.3** *LC<sub>50</sub> for acute toxicity on inhalation* is that concentration of vapour, mist or dust which, administered by continuous inhalation to both male and female young adult albino rats for one hour, is most likely to cause death within 14 days in one half of the animals tested. A solid substance shall be tested if at least 10% (by mass) of its total mass is likely to be dust in the respirable range, such as the aerodynamic diameter of that particle fraction is 10 microns or less. A liquid substance shall be tested if a mist is likely to be generated in a leakage of the transport containment. For both solid and liquid substances, more than 90% (by mass) of a specimen prepared for inhalation toxicity testing shall be in the respirable range as defined above. The result is expressed in milligrams per litre of air for dusts and mists or in millilitres per cubic metre of air (parts per million) for vapours.
- 2.6.2.1.4** *Properties*
- .1 The dangers of poisoning which are inherent in these substances depend upon contact with the human body, that is by inhalation of vapours by unsuspecting persons at some distance from the cargo or the immediate dangers of physical contact with the substance. These have been considered in the context of the probability of accident occurring during transport by sea.

- .2 Nearly all toxic substances evolve toxic gases when involved in a fire or when heated to decomposition.
- .3 A substance specified as “stabilized” shall not be transported in an unstabilized condition.

**2.6.2.2 Assignment of packing groups to toxic substances**

2.6.2.2.1 Toxic substances have for packing purposes been apportioned among packing groups according to the degree of their toxic hazards in transport:

- .1 Packing group I: substances and preparations presenting a high toxicity risk;
- .2 Packing group II: substances and preparations presenting a medium toxicity risk;
- .3 Packing group III: substances and preparations presenting a low toxicity risk.

2.6.2.2.2 In making this grouping, account has been taken of human experience in instances of accidental poisoning, and of special properties possessed by any individual substance, such as liquid state, high volatility, any special likelihood of penetration, and special biological effects.

2.6.2.2.3 In the absence of human experience, the grouping has been based on data obtained from animal experiments. Three possible routes of administration have been examined. These routes are exposure through:

- oral ingestion;
- dermal contact; and
- inhalation of dusts, mists or vapours.

2.6.2.2.3.1 For appropriate animal test data for the various routes of exposure, see 2.6.2.1. When a substance exhibits a different order of toxicity by two or more routes of administration, the highest degree of danger indicated by the tests has been used in assigning the packing group.

2.6.2.2.4 The criteria to be applied for grouping a substance according to the toxicity it exhibits by all three routes of administration are presented in the following paragraphs.

2.6.2.2.4.1 The grouping criteria for the oral and dermal routes as well as for inhalation of dusts and mists are shown in the following table:

**Grouping criteria for administration through oral ingestion, dermal contact and inhalation of dusts and mists**

Packing group	Oral toxicity LD <sub>50</sub> (mg/kg)	Dermal toxicity LD <sub>50</sub> (mg/kg)	Inhalation toxicity by dusts and mists LC <sub>50</sub> (mg/l)
I	≤ 5.0	≤ 50	≤ 0.2
II	> 5.0 and ≤ 50	> 50 and ≤ 200	> 0.2 and ≤ 2.0
III*	> 50 and ≤ 300	> 200 and ≤ 1000	> 2.0 and ≤ 4.0

\* Tear gas substances shall be included in packing group II even if their toxicity data correspond to packing group III values.

**Note:** Substances meeting the criteria of class 8 and with an inhalation toxicity of dusts and mists (LC<sub>50</sub>) leading to packing group I are only accepted for an allocation to class 6.1 if the toxicity through oral ingestion or dermal contact is at least in the range of packing group I or II. Otherwise an allocation to class 8 is made when appropriate (see 2.8.2.3).

2.6.2.2.4.2 The criteria for inhalation toxicity of dusts and mists in 2.6.2.2.4.1 are based on LC<sub>50</sub> data relating to one hour exposures, and where such information is available it shall be used. However, where only LC<sub>50</sub> data relating to 4-hour exposures to dusts and mists are available, such figures can be multiplied by four and the product substituted in the above criteria, i.e. LC<sub>50</sub> (4 hours) × 4 is considered the equivalent of LC<sub>50</sub> (1 hour).

2.6.2.2.4.3 Liquids having toxic vapours shall be assigned to the following packing groups, where “V” is the saturated vapour concentration in mL/m<sup>3</sup> air at 20°C and standard atmospheric pressure:

Packing group I: if  $V \geq 10 \text{ LC}_{50}$  and  $\text{LC}_{50} \leq 1000 \text{ mL/m}^3$ .

Packing group II: if  $V \geq \text{LC}_{50}$  and  $\text{LC}_{50} \leq 3000 \text{ mL/m}^3$ , and do not meet the criteria for packing group I.

Packing group III: if  $V \geq \frac{1}{5} \text{ LC}_{50}$  and  $\text{LC}_{50} \leq 5000 \text{ mL/m}^3$ , and do not meet the criteria for packing groups I or II.

**Note:** Tear gas substances shall be included in packing group II even if their toxicity data correspond to packing group III values.

Part 2 – Classification

2.6.2.2.4.4 In figure 2-3 the criteria according to 2.6.2.2.4.3 are expressed in graphical form, as an aid to easy classification. Because of approximations inherent in the use of graphs, substances falling on or near packing group borderlines shall be checked using numerical criteria.

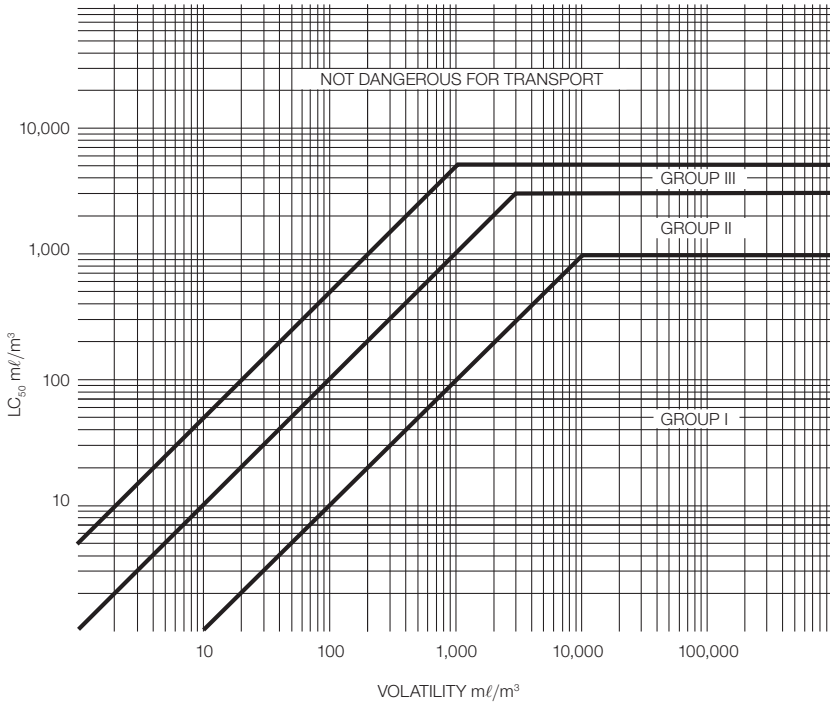

Figure 2-3 – Inhalation toxicity: packing group borderlines

2.6.2.2.4.5 The criteria for inhalation toxicity of vapours in 2.6.2.2.4.3 are based on LC<sub>50</sub> data relating to one hour exposures, and where such information is available it shall be used. However, where only LC<sub>50</sub> data relating to 4-hour exposures to the vapours are available, such figures can be multiplied by two and the product substituted in the above criteria, i.e. LC<sub>50</sub> (4 hours) × 2 is considered the equivalent of LC<sub>50</sub> (1 hour).

2.6.2.2.4.6 Mixtures of liquids that are toxic by inhalation shall be assigned to packing groups according to 2.6.2.2.4.7 and 2.6.2.2.4.8.

2.6.2.2.4.7 If LC<sub>50</sub> data are available for each of the toxic substances comprising a mixture, the packing group may be determined as follows:

- .1 Estimate the LC<sub>50</sub> of the mixture using the formula:

$$LC_{50}(\text{mixture}) = \frac{1}{\sum_{i=1}^n \left( \frac{f_i}{LC_{50i}} \right)}$$

where:  $f_i$  = mole fraction of the  $i^{\text{th}}$  component substance of the mixture  
 $LC_{50i}$  = mean lethal concentration of the  $i^{\text{th}}$  component substance in mL/m<sup>3</sup>.

- .2 Estimate the volatility of each component substance comprising the mixture using the formula:

$$V_i = \left( \frac{P_i \times 10^6}{101.3} \right) \text{ mL/m}^3$$

where:  $P_i$  = the partial pressure of the  $i^{\text{th}}$  component substance in kPa at 20°C and one atmosphere pressure.

- .3 Calculate the ratio of the volatility to the LC<sub>50</sub> using the formula:

$$R = \sum_{i=1}^n \left( \frac{V_i}{LC_{50i}} \right)$$



- .4 Using the calculated values of LC<sub>50</sub> (mixture) and *R*, the packing group for the mixture is determined:  
**Packing group I:**  $R \geq 10$  and LC<sub>50</sub> (mixture)  $\leq 1000 \text{ mL/m}^3$ .  
**Packing group II:**  $R \geq 1$  and LC<sub>50</sub> (mixture)  $\leq 3000 \text{ mL/m}^3$  and not meeting criteria for packing group I.  
**Packing group III:**  $R \geq \frac{1}{5}$  and LC<sub>50</sub> (mixture)  $\leq 5000 \text{ mL/m}^3$  and not meeting criteria for packing groups I or II.

2.6.2.2.4.8 In the absence of LC<sub>50</sub> data on the toxic constituent substances, the mixture may be assigned a packing group based on the following simplified threshold toxicity tests. When these threshold tests are used, the most restrictive packing group shall be determined and used for transporting the mixture.

- .1 A mixture is assigned to packing group I only if it meets both of the following criteria:
  - A sample of the liquid mixture is vaporized and diluted with air to create a test atmosphere of 1000 mL/m<sup>3</sup> vaporized mixture in air. Ten albino rats (five male and five female) are exposed to the test atmosphere for one hour and observed for 14 days. If five or more of the animals die within the 14-day observation period, the mixture is presumed to have an LC<sub>50</sub> equal to or less than 1000 mL/m<sup>3</sup>.
  - A sample of the vapour in equilibrium with the liquid mixture at 20°C is diluted with 9 equal volumes of air to form a test atmosphere. Ten albino rats (five male and five female) are exposed to the test atmosphere for one hour and observed for 14 days. If five or more of the animals die within the 14-day observation period, the mixture is presumed to have a volatility equal to or greater than 10 times the mixture LC<sub>50</sub>.
- .2 A mixture is assigned to packing group II only if it meets both of the following criteria, and the mixture does not meet the criteria for packing group I:
  - A sample of the liquid mixture is vaporized and diluted with air to create a test atmosphere of 3000 mL/m<sup>3</sup> vaporized mixture in air. Ten albino rats (five male and five female) are exposed to the test atmosphere for one hour and observed for 14 days. If five or more of the animals die within the 14-day observation period, the mixture is presumed to have an LC<sub>50</sub> equal to or less than 3000 mL/m<sup>3</sup>.
  - A sample of the vapour in equilibrium with the liquid mixture at 20°C is used to form a test atmosphere. Ten albino rats (five male and five female) are exposed to the test atmosphere for one hour and observed for 14 days. If five or more of the animals die within the 14-day observation period, the mixture is presumed to have a volatility equal to or greater than the mixture LC<sub>50</sub>.
- .3 A mixture is assigned to packing group III only if it meets both of the following criteria, and the mixture does not meet the criteria for packing groups I or II:
  - A sample of the liquid mixture is vaporized and diluted with air to create a test atmosphere of 5000 mL/m<sup>3</sup> vaporized mixture in air. Ten albino rats (five male and five female) are exposed to the test atmosphere for one hour and observed for 14 days. If five or more of the animals die within the 14-day observation period, the mixture is presumed to have an LC<sub>50</sub> equal to or less than 5000 mL/m<sup>3</sup>.
  - The vapour pressure of the liquid mixture is measured and if the vapour concentration is equal to or greater than 1000 mL/m<sup>3</sup>, the mixture is presumed to have a volatility equal to or greater than  $\frac{1}{5}$  the mixture LC<sub>50</sub>.

### 2.6.2.3 Methods for determining oral and dermal toxicity of mixtures

2.6.2.3.1 When classifying and assigning the appropriate packing group to mixtures in class 6.1, in accordance with the oral and dermal toxicity criteria in 2.6.2.2, it is necessary to determine the acute LD<sub>50</sub> of the mixture.

2.6.2.3.2 If a mixture contains only one active substance, and the LD<sub>50</sub> of that constituent is known, in the absence of reliable acute oral and dermal toxicity data on the actual mixture to be transported, the oral or dermal LD<sub>50</sub> may be obtained by the following method:

$$\text{LD}_{50} \text{ value of preparation} = \frac{\text{LD}_{50} \text{ value of active substance} \times 100}{\text{percentage of active substance by mass}}$$

2.6.2.3.3 If a mixture contains more than one active constituent, there are three possible approaches that may be used to determine the oral or dermal LD<sub>50</sub> of the mixture. The preferred method is to obtain reliable acute oral and dermal toxicity data on the actual mixture to be transported. If reliable, accurate data are not available, then either of the following methods may be performed:

- .1 Classify the formulation according to the most hazardous constituent of the mixture as if that constituent were present in the same concentration as the total concentration of all active constituents; or
- .2 Apply the formula:

$$\frac{C_A}{T_A} + \frac{C_B}{T_B} + \dots + \frac{C_Z}{T_Z} = \frac{100}{T_M}$$

where: C = the % concentration of constituent A, B . . . Z in the mixture;

T = the oral LD<sub>50</sub> value of constituent A, B . . . Z;

T<sub>M</sub> = the oral LD<sub>50</sub> value of the mixture.

## Part 2 – Classification

**Note:** This formula can also be used for dermal toxicities provided that this information is available on the same species for all constituents. The use of this formula does not take into account any potentiation or protective phenomena.

## 2.6.2.4 Classification of pesticides

2.6.2.4.1 All active pesticide substances and their preparations for which the  $LC_{50}$  and/or  $LD_{50}$  values are known and which are classified in class 6.1 shall be classified under appropriate packing groups in accordance with the criteria given in 2.6.2.2. Substances and preparations which are characterized by subsidiary risks shall be classified according to the precedence of hazard table in 2.0.3 with the assignment of appropriate packing groups.

2.6.2.4.2 If the oral or dermal  $LD_{50}$  value for a pesticide preparation is not known, but the  $LD_{50}$  value of its active substance(s) is known, the  $LD_{50}$  value for the preparation may be obtained by applying the procedures in 2.6.2.3.

**Note:**  $LD_{50}$  toxicity data for a number of common pesticides may be obtained from the most current edition of "The WHO Recommended Classification of Pesticides by Hazard and Guidelines to Classification", available from the International Programme on Chemical Safety, World Health Organization (WHO), 1211 Geneva 27, Switzerland. While that publication may be used as a source of  $LD_{50}$  data for pesticides, its classification system shall not be used for purposes of transport classification of, or assignment of packing groups to, pesticides, which shall be in accordance with the provisions of this Code.

2.6.2.4.3 The Proper Shipping Name used in the transport of the pesticide shall be selected from those referenced on the basis of the active ingredient, of the physical state of the pesticide and any subsidiary risks which it may exhibit.

## 2.6.3 Class 6.2 – Infectious substances

## 2.6.3.1 Definitions

For the purposes of this Code:

2.6.3.1.1 *Infectious substances* are substances which are known or are reasonably expected to contain pathogens. Pathogens are defined as micro-organisms (including bacteria, viruses, rickettsiae, parasites, fungi) and other agents such as prions, which can cause disease in humans or animals.

2.6.3.1.2 *Biological products* are those products derived from living organisms which are manufactured and distributed in accordance with the requirements of appropriate national authorities, which may have special licensing requirements, and are used either for prevention, treatment, or diagnosis of disease in humans or animals, or for development, experimental or investigation purposes related thereto. They include, but are not limited to, finished or unfinished products such as vaccines.

2.6.3.1.3 *Cultures* are the result of a process by which pathogens are intentionally propagated. This definition does not include human or animal patient specimens as defined in 2.6.3.1.4.

2.6.3.1.4 *Patient specimens* are human or animal materials, collected directly from humans or animals, including, but not limited to, excreta, secreta, blood and its components, tissue and tissue fluid swabs, and body parts being transported for purposes such as research, diagnosis, investigational activities, disease treatment and prevention.

2.6.3.1.5 [Reserved]

2.6.3.1.6 *Medical or clinical wastes* are wastes derived from the medical treatment of animals or humans or from bio-research.

## 2.6.3.2 Classification of infectious substances

2.6.3.2.1 Infectious substances shall be classified in class 6.2 and assigned to UN 2814, UN 2900, UN 3291 or UN 3373, as appropriate.

2.6.3.2.2 Infectious substances are divided into the following categories:

2.6.3.2.2.1 *Category A:* An infectious substance which is transported in a form that, when exposure to it occurs, is capable of causing permanent disability, life-threatening or fatal disease in otherwise healthy humans or animals. Indicative examples of substances that meet these criteria are given in the table in this paragraph.

**Note:** An exposure occurs when an infectious substance is released outside the protective packaging, resulting in physical contact with humans or animals.

- (a) Infectious substances meeting these criteria which cause disease in humans or in both humans and animals shall be assigned to UN 2814. Infectious substances which cause disease only in animals shall be assigned to UN 2900.
- (b) Assignment to UN 2814 or UN 2900 shall be based on the known medical history and symptoms of the source human or animal, endemic local conditions, or professional judgement concerning individual circumstances of the human or animal source.

**Note 1:** The Proper Shipping Name for UN 2814 is INFECTIOUS SUBSTANCE, AFFECTING HUMANS. The Proper Shipping Name for UN 2900 is INFECTIOUS SUBSTANCE, AFFECTING ANIMALS only.

**Note 2:** The following table is not exhaustive. Infectious substances, including new or emerging pathogens, which do not appear in the table but which meet the same criteria shall be assigned to Category A. In addition, if there is doubt as to whether or not a substance meets the criteria it shall be included in Category A.

**Note 3:** In the following table, the microorganism names written in italics are bacteria, mycoplasmas, rickettsiae or fungi.

**Indicative examples of infectious substances included in category A in any form unless otherwise indicated (2.6.3.2.2.1 (a))**

UN Number and Proper Shipping Name	Micro-organism
UN 2814 Infectious substance, affecting humans	<i>Bacillus anthracis</i> (cultures only) <i>Brucella abortus</i> (cultures only) <i>Brucella melitensis</i> (cultures only) <i>Brucella suis</i> (cultures only) <i>Burkholderia mallei</i> – <i>Pseudomonas mallei</i> – Glanders (cultures only) <i>Burkholderia pseudomallei</i> – <i>Pseudomonas pseudomallei</i> (cultures only) <i>Chlamydia psittaci</i> – avian strains (cultures only) <i>Clostridium botulinum</i> (cultures only) <i>Coccidioides immitis</i> (cultures only) <i>Coxiella burnetii</i> (cultures only) Crimean-Congo hemorrhagic fever virus Dengue virus (cultures only) Eastern equine encephalitis virus (cultures only) <i>Escherichia coli</i> , verotoxigenic (cultures only) Ebola virus Flexal virus <i>Francisella tularensis</i> (cultures only) Guanarito virus Hantaan virus Hantavirus causing hemorrhagic fever with renal syndrome Hendra virus Hepatitis B virus (cultures only) Herpes B virus (cultures only) Human immunodeficiency virus (cultures only) Highly pathogenic avian influenza virus (cultures only) Japanese Encephalitis virus (cultures only) Junin virus Kysanur Forest disease virus Lassa virus Machupo virus Marburg virus Monkeypox virus <i>Mycobacterium tuberculosis</i> (cultures only) Nipah virus Omsk hemorrhagic fever virus Poliovirus (cultures only) Rabies virus (cultures only) <i>Rickettsia prowazekii</i> (cultures only) <i>Rickettsia rickettsii</i> (cultures only)

Part 2 – Classification

UN Number and Proper Shipping Name	Micro-organism
<b>UN 2814</b> <b>Infectious substance, affecting humans</b> <i>(cont.)</i>	Rift Valley fever virus (cultures only) Russian spring–summer encephalitis virus (cultures only) Sabia virus <i>Shigella dysenteriae</i> type 1 (cultures only) Tick-borne encephalitis virus (cultures only) Variola virus Venezuelan equine encephalitis virus (cultures only) West Nile virus (cultures only) Yellow fever virus (cultures only) <i>Yersinia pestis</i> (cultures only)
<b>UN 2900</b> <b>Infectious substance, affecting animals only</b>	African swine fever virus (cultures only) Avian paramyxovirus Type 1 – Velogenic Newcastle disease virus (cultures only) Classical swine fever virus (cultures only) Foot and mouth disease virus (cultures only) Lumpy skin disease virus (cultures only) <i>Mycoplasma mycoides</i> – Contagious bovine pleuropneumonia (cultures only) Peste des petits ruminants virus (cultures only) Rinderpest virus (cultures only) Sheep-pox virus (cultures only) Goatpox virus (cultures only) Swine vesicular disease virus (cultures only) Vesicular stomatitis virus (cultures only)

2.6.3.2.2.2 *Category B*: An infectious substance which does not meet the criteria for inclusion in Category A. Infectious substances in Category B shall be assigned to UN 3373.

**Note:** The Proper Shipping Name for UN 3373 is “BIOLOGICAL SUBSTANCE, CATEGORY B”.

2.6.3.2.3 *Exemptions*

2.6.3.2.3.1 Substances which do not contain infectious substances or substances which are unlikely to cause disease in humans or animals are not subject to the provisions of this Code, unless they meet the criteria for inclusion in another class.

2.6.3.2.3.2 Substances containing microorganisms which are non-pathogenic to humans or animals are not subject to the provisions of this Code unless they meet the criteria for inclusion in another class.

2.6.3.2.3.3 Substances in a form that any present pathogens have been neutralized or inactivated such that they no longer pose a health risk are not subject to the provisions of this Code unless they meet the criteria for inclusion in another class.

**Note:** Medical equipment which has been drained of free liquid is deemed to meet the requirements of this paragraph and is not subject to the provisions of this Code.

2.6.3.2.3.4 Environmental samples (including food and water samples) which are not considered to pose a significant risk of infection are not subject to the provisions of this Code unless they meet the criteria for inclusion in another class.

2.6.3.2.3.5 Dried blood spots, collected by applying a drop of blood onto absorbent material, or faecal occult blood screening tests and blood or blood components which have been collected for the purposes of transfusion or for the preparation of blood products to be used for transfusion or transplantation and any tissues or organs intended for use in transplants are not subject to this Code.

2.6.3.2.3.6 Human or animal specimens for which there is minimal likelihood that pathogens are present are not subject to the provisions of this Code if the specimen is transported in a packaging which will prevent any leakage and which is marked with the words “Exempt human specimen” or “Exempt animal specimen”, as appropriate. The packaging should meet the following conditions:

- (a) The packaging should consist of three components:
  - (i) a leak-proof primary receptacle(s);
  - (ii) a leak-proof secondary packaging; and
  - (iii) an outer packaging of adequate strength for its capacity, mass and intended use, and with at least one surface having minimum dimensions of 100 mm × 100 mm;

- (b) For liquids, absorbent material in sufficient quantity to absorb the entire contents should be placed between the primary receptacle(s) and the secondary packaging so that, during transport, any release or leak of a liquid substance will not reach the outer packaging and will not compromise the integrity of the cushioning material;
- (c) When multiple fragile primary receptacles are placed in a single secondary packaging, they should be either individually wrapped or separated to prevent contact between them.

**Note:** An element of professional judgement is required to determine if a substance is exempt under this paragraph. That judgement should be based on the known medical history, symptoms and individual circumstances of the source, human or animal, and endemic local conditions. Examples of specimens which may be transported under this paragraph include the blood or urine tests to monitor cholesterol levels, blood glucose levels, hormone levels, or prostate specific antibodies (PSA); those required to monitor organ function such as heart, liver or kidney function for humans or animals with non-infectious diseases, or therapeutic drug monitoring; those conducted for insurance or employment purposes and are intended to determine the presence of drugs or alcohol; pregnancy test; biopsies to detect cancer; and antibody detection in humans or animals in the absence of any concern for infection (e.g., evaluation of vaccine-induced immunity, diagnosis of autoimmune disease, etc.).

**2.6.3.2.3.7** Except for:

- (a) Medical waste (UN 3291);
- (b) Medical devices or equipment contaminated with or containing infectious substances in Category A (UN 2814 or UN 2900); and
- (c) Medical devices or equipment contaminated with or containing other dangerous goods that meet the definition of another hazard class,

medical devices or equipment potentially contaminated with or containing infectious substances which are being transported for disinfection, cleaning, sterilization, repair, or equipment evaluation are not subject to the provisions of this Code if packed in packagings designed and constructed in such a way that, under normal conditions of transport, they cannot break, be punctured or leak their contents. Packagings shall be designed to meet the construction requirements listed in 6.1.4 or 6.6.5.

These packagings shall meet the general packing requirements of 4.1.1.1 and 4.1.1.2 and be capable of retaining the medical devices and equipment when dropped from a height of 1.2 m.

The packagings shall be marked "USED MEDICAL DEVICE" or "USED MEDICAL EQUIPMENT". When using overpacks, or unit loads these shall be marked in the same way, except when the inscription remains visible.

**2.6.3.3 Biological products**

**2.6.3.3.1** For the purposes of this Code, biological products are divided into the following groups:

- (a) those which are manufactured and packaged in accordance with the requirements of appropriate national authorities and transported for the purposes of final packaging or distribution, and use for personal health care by medical professionals or individuals. Substances in this group are not subject to the provisions of this Code.
- (b) those which do not fall under (a) and are known or reasonably believed to contain infectious substances and which meet the criteria for inclusion in Category A or Category B. Substances in this group shall be assigned to UN 2814, UN 2900 or UN 3373, as appropriate.

**Note:** Some licensed biological products may present a biohazard only in certain parts of the world. Competent authorities may require that such biological products comply with local requirements for infectious substances or may impose other restrictions.

**2.6.3.4 Genetically modified microorganisms and organisms**

**2.6.3.4.1** Genetically modified microorganisms not meeting the definition of infectious substance shall be classified in accordance with chapter 2.9.

**2.6.3.5 Medical or clinical wastes**

**2.6.3.5.1** Medical or clinical wastes containing Category A infectious substances shall be assigned to UN 2814 or UN 2900, as appropriate. Medical or clinical wastes containing infectious substances in Category B shall be assigned to UN 3291.

Part 2 – Classification

---

2.6.3.5.2 Medical or clinical wastes which are reasonably believed to have a low probability of containing infectious substances shall be assigned to UN 3291. For the assignment, international, regional or national waste catalogues may be taken into account.

**Note:** The Proper Shipping Name for UN 3291 is CLINICAL WASTE, UNSPECIFIED, N.O.S. or (BIO) MEDICAL WASTE, N.O.S. or REGULATED MEDICAL WASTE, N.O.S.

2.6.3.5.3 Decontaminated medical or clinical wastes which previously contained infectious substances are not subject to the provisions of this Code unless they meet the criteria for inclusion in another class.

2.6.3.6 **Infected animals**

2.6.3.6.1 Unless an infectious substance cannot be consigned by any other means, live animals shall not be used to consign such a substance. A live animal which has been intentionally infected and is known or suspected to contain an infectious substance shall only be transported under terms and conditions approved by the competent authority.

2.6.3.6.2 Animal material affected by pathogens of Category A or which would be assigned to Category A in cultures only, shall be assigned to UN 2814 or UN 2900 as appropriate. Animal material affected by pathogens of Category B other than those which would be assigned to Category A if they were in cultures shall be assigned to UN 3373.

## Chapter 2.7

### Class 7 – Radioactive material

**Note:** For class 7, the type of packaging may have a decisive effect on classification.

#### 2.7.1 Definitions

**2.7.1.1** *Radioactive material* means any material containing radionuclides where both the activity concentration and the total activity in the consignment exceed the values specified in 2.7.2.2.1 to 2.7.2.2.6.

#### 2.7.1.2 Contamination

*Contamination* means the presence of a radioactive substance on a surface in quantities in excess of 0.4 Bq/cm<sup>2</sup> for beta and gamma emitters and low-toxicity alpha emitters, or 0.04 Bq/cm<sup>2</sup> for all other alpha emitters.

*Non-fixed contamination* means contamination that can be removed from a surface during routine conditions of transport.

*Fixed contamination* means contamination other than non-fixed contamination.

#### 2.7.1.3 Definitions of specific terms

$A_1$  and  $A_2$

$A_1$  means the activity value of special form radioactive material which is listed in the table in 2.7.2.2.1 or derived in 2.7.2.2.2 and is used to determine the activity limits for the provisions of this Code.

$A_2$  means the activity value of radioactive material, other than special form radioactive material, which is listed in the table in 2.7.2.2.1 or derived in 2.7.2.2.2 and is used to determine the activity limits for the provisions of this Code.

*Fissile nuclides* means uranium-233, uranium-235, plutonium-239 and plutonium-241. *Fissile material* means a material containing any of the fissile nuclides. Excluded from the definition of fissile material are:

- .1 Natural uranium or depleted uranium which is unirradiated; and
- .2 Natural uranium or depleted uranium which has been irradiated in thermal reactors only.

*Low dispersible radioactive material* means either a solid radioactive material or a solid radioactive material in a sealed capsule, that has limited dispersibility and is not in powder form.

*Low specific activity (LSA) material* means radioactive material which by its nature has a limited specific activity, or radioactive material for which limits of estimated average specific activity apply. External shielding materials surrounding the LSA material shall not be considered in determining the estimated average specific activity.

*Low toxicity alpha emitters* are: natural uranium; depleted uranium; natural thorium; uranium-235 or uranium-238; thorium-232; thorium-228 and thorium-230 when contained in ores or physical and chemical concentrates; or alpha emitters with a half-life of less than 10 days.

*Specific activity of a radionuclide* means the activity per unit mass of that nuclide. The specific activity of a material shall mean the activity per unit mass of the material in which the radionuclides are essentially uniformly distributed.

*Special form radioactive material* means either:

- .1 An indispersible solid radioactive material; or
- .2 A sealed capsule containing radioactive material.

*Surface contaminated object (SCO)* means a solid object which is not itself radioactive but which has radioactive material distributed on its surfaces.

*Unirradiated thorium* means thorium containing not more than  $10^{-7}$  g of uranium-233 per gram of thorium-232.

Part 2 – Classification

*Unirradiated uranium* means uranium containing not more than  $2 \times 10^3$  Bq of plutonium per gram of uranium-235, not more than  $9 \times 10^6$  Bq of fission products per gram of uranium-235 and not more than  $5 \times 10^3$  g of uranium-236 per gram of uranium-235.

*Uranium – natural, depleted, enriched* means the following:

*Natural uranium* means uranium (which may be chemically separated) containing the naturally occurring distribution of uranium isotopes (approximately 99.28% uranium-238, and 0.72% uranium-235 by mass).

*Depleted uranium* means uranium containing a lesser mass percentage of uranium-235 than in natural uranium.

*Enriched uranium* means uranium containing a greater mass percentage of uranium-235 than 0.72%.

In all cases, a very small mass percentage of uranium-234 is present.

## 2.7.2 Classification

### 2.7.2.1 General provisions

2.7.2.1.1 Radioactive material shall be assigned to one of the UN Numbers specified in table 2.7.2.1.1 depending on the activity level of the radionuclides contained in a package, the fissile or non-fissile properties of these radionuclides, the type of package to be presented for transport, and the nature or form of the contents of the package, or special arrangements governing the transport operation, in accordance with the provisions laid down in 2.7.2.2 to 2.7.2.5.

Table 2.7.2.1.1 – Assignment of UN Numbers

<b>Excepted packages (1.5.1.5)</b>	
UN 2908	RADIOACTIVE MATERIAL, EXCEPTED PACKAGE – EMPTY PACKAGING
UN 2909	RADIOACTIVE MATERIAL, EXCEPTED PACKAGE – ARTICLES MANUFACTURED FROM NATURAL URANIUM or DEPLETED URANIUM or NATURAL THORIUM
UN 2910	RADIOACTIVE MATERIAL, EXCEPTED PACKAGE – LIMITED QUANTITY OF MATERIAL
UN 2911	RADIOACTIVE MATERIAL, EXCEPTED PACKAGE – INSTRUMENTS or ARTICLES
<b>Low specific activity radioactive material (2.7.2.3.1)</b>	
UN 2912	RADIOACTIVE MATERIAL, LOW SPECIFIC ACTIVITY (LSA-I), non-fissile or fissile – excepted
UN 3321	RADIOACTIVE MATERIAL, LOW SPECIFIC ACTIVITY (LSA-II), non-fissile or fissile – excepted
UN 3322	RADIOACTIVE MATERIAL, LOW SPECIFIC ACTIVITY (LSA-III), non-fissile or fissile – excepted
UN 3324	RADIOACTIVE MATERIAL, LOW SPECIFIC ACTIVITY (LSA-II), FISSILE
UN 3325	RADIOACTIVE MATERIAL, LOW SPECIFIC ACTIVITY (LSA-III), FISSILE
<b>Surface contaminated objects (2.7.2.3.2)</b>	
UN 2913	RADIOACTIVE MATERIAL, SURFACE CONTAMINATED OBJECTS (SCO-I or SCO-II), non-fissile or fissile – excepted
UN 3326	RADIOACTIVE MATERIAL, SURFACE CONTAMINATED OBJECTS (SCO-I or SCO-II), FISSILE
<b>Type A packages (2.7.2.4.4)</b>	
UN 2915	RADIOACTIVE MATERIAL, TYPE A PACKAGE, non-special form, non-fissile or fissile – excepted
UN 3327	RADIOACTIVE MATERIAL, TYPE A PACKAGE, FISSILE, non-special form
UN 3332	RADIOACTIVE MATERIAL, TYPE A PACKAGE, SPECIAL FORM, non-fissile or fissile – excepted
UN 3333	RADIOACTIVE MATERIAL, TYPE A PACKAGE, SPECIAL FORM, FISSILE
<b>Type B(U) package (2.7.2.4.6)</b>	
UN 2916	RADIOACTIVE MATERIAL, TYPE B(U) PACKAGE, non-fissile or fissile – excepted
UN 3328	RADIOACTIVE MATERIAL, TYPE B(U) PACKAGE, FISSILE



<b>Type B(M) package</b> (2.7.2.4.6)	
UN 2917	RADIOACTIVE MATERIAL, TYPE B(M) PACKAGE, non-fissile or fissile – excepted
UN 3329	RADIOACTIVE MATERIAL, TYPE B(M) PACKAGE, FISSILE
<b>Type C package</b> (2.7.2.4.6)	
UN 3323	RADIOACTIVE MATERIAL, TYPE C PACKAGE, non-fissile or fissile – excepted
UN 3330	RADIOACTIVE MATERIAL, TYPE C PACKAGE, FISSILE
<b>Special arrangement</b> (2.7.2.5)	
UN 2919	RADIOACTIVE MATERIAL, TRANSPORTED UNDER SPECIAL ARRANGEMENT, non-fissile or fissile – excepted
UN 3331	RADIOACTIVE MATERIAL, TRANSPORTED UNDER SPECIAL ARRANGEMENT, FISSILE
<b>Uranium hexafluoride</b> (2.7.2.4.5)	
UN 2977	RADIOACTIVE MATERIAL, URANIUM HEXAFLUORIDE, FISSILE
UN 2978	RADIOACTIVE MATERIAL, URANIUM HEXAFLUORIDE, non-fissile or fissile – excepted

### 2.7.2.2 Determination of activity level

2.7.2.2.1 The following basic values for individual radionuclides are given in table 2.7.2.2.1:

- 1  $A_1$  and  $A_2$  in TBq;
- 2 Activity concentration for exempt material in Bq/g; and
- 3 Activity limits for exempt consignments in Bq.

Table 2.7.2.2.1 – Basic radionuclides values for individual radionuclides

Radionuclide (atomic number)	$A_1$ (TBq)	$A_2$ (TBq)	Activity concentration for exempt material (Bq/g)	Activity limit for an exempt consignment (Bq)
<b>Actinium (89)</b>				
Ac-225 (a)	$8 \times 10^{-1}$	$6 \times 10^{-3}$	$1 \times 10^1$	$1 \times 10^4$
Ac-227 (a)	$9 \times 10^{-1}$	$9 \times 10^{-5}$	$1 \times 10^{-1}$	$1 \times 10^3$
Ac-228	$6 \times 10^{-1}$	$5 \times 10^{-1}$	$1 \times 10^1$	$1 \times 10^6$
<b>Silver (47)</b>				
Ag-105	$2 \times 10^0$	$2 \times 10^0$	$1 \times 10^2$	$1 \times 10^5$
Ag-108m (a)	$7 \times 10^{-1}$	$7 \times 10^{-1}$	$1 \times 10^1$ (b)	$1 \times 10^6$ (b)
Ag-110m (a)	$4 \times 10^{-1}$	$4 \times 10^{-1}$	$1 \times 10^1$	$1 \times 10^6$
Ag-111	$2 \times 10^0$	$6 \times 10^{-1}$	$1 \times 10^3$	$1 \times 10^6$
<b>Aluminium (13)</b>				
Al-26	$1 \times 10^{-1}$	$1 \times 10^{-1}$	$1 \times 10^1$	$1 \times 10^5$
<b>Americium (95)</b>				
Am-241	$1 \times 10^1$	$1 \times 10^{-3}$	$1 \times 10^0$	$1 \times 10^4$
Am-242m (a)	$1 \times 10^3$	$1 \times 10^{-3}$	$1 \times 10^0$ (b)	$1 \times 10^4$ (b)
Am-243 (a)	$5 \times 10^0$	$1 \times 10^{-3}$	$1 \times 10^0$ (b)	$1 \times 10^3$ (b)
<b>Argon (18)</b>				
Ar-37	$4 \times 10^1$	$4 \times 10^1$	$1 \times 10^6$	$1 \times 10^8$
Ar-39	$4 \times 10^1$	$2 \times 10^1$	$1 \times 10^7$	$1 \times 10^4$
Ar-41	$3 \times 10^{-1}$	$3 \times 10^{-1}$	$1 \times 10^2$	$1 \times 10^9$
<b>Arsenic (33)</b>				
As-72	$3 \times 10^{-1}$	$3 \times 10^{-1}$	$1 \times 10^1$	$1 \times 10^5$
As-73	$4 \times 10^1$	$4 \times 10^1$	$1 \times 10^3$	$1 \times 10^7$
As-74	$1 \times 10^0$	$9 \times 10^{-1}$	$1 \times 10^1$	$1 \times 10^6$
As-76	$3 \times 10^{-1}$	$3 \times 10^{-1}$	$1 \times 10^2$	$1 \times 10^5$
As-77	$2 \times 10^1$	$7 \times 10^{-1}$	$1 \times 10^3$	$1 \times 10^6$
<b>Astatine (85)</b>				
At-211 (a)	$2 \times 10^1$	$5 \times 10^{-1}$	$1 \times 10^3$	$1 \times 10^7$
<b>Gold (79)</b>				
Au-193	$7 \times 10^0$	$2 \times 10^0$	$1 \times 10^2$	$1 \times 10^7$
Au-194	$1 \times 10^0$	$1 \times 10^0$	$1 \times 10^1$	$1 \times 10^6$

Part 2 – Classification

Radionuclide (atomic number)	A <sub>1</sub> (TBq)	A <sub>2</sub> (TBq)	Activity concentration for exempt material (Bq/g)	Activity limit for an exempt consignment (Bq)
Au-195	1 × 10 <sup>1</sup>	6 × 10 <sup>0</sup>	1 × 10 <sup>2</sup>	1 × 10 <sup>7</sup>
Au-198	1 × 10 <sup>0</sup>	6 × 10 <sup>-1</sup>	1 × 10 <sup>2</sup>	1 × 10 <sup>6</sup>
Au-199	1 × 10 <sup>1</sup>	6 × 10 <sup>-1</sup>	1 × 10 <sup>2</sup>	1 × 10 <sup>6</sup>
<b>Barium (56)</b>				
Ba-131 (a)	2 × 10 <sup>0</sup>	2 × 10 <sup>0</sup>	1 × 10 <sup>2</sup>	1 × 10 <sup>6</sup>
Ba-133	3 × 10 <sup>0</sup>	3 × 10 <sup>0</sup>	1 × 10 <sup>2</sup>	1 × 10 <sup>6</sup>
Ba-133m	2 × 10 <sup>1</sup>	6 × 10 <sup>-1</sup>	1 × 10 <sup>2</sup>	1 × 10 <sup>6</sup>
Ba-140 (a)	5 × 10 <sup>-1</sup>	3 × 10 <sup>-1</sup>	1 × 10 <sup>1</sup> (b)	1 × 10 <sup>5</sup> (b)
<b>Beryllium (4)</b>				
Be-7	2 × 10 <sup>1</sup>	2 × 10 <sup>1</sup>	1 × 10 <sup>3</sup>	1 × 10 <sup>7</sup>
Be-10	4 × 10 <sup>1</sup>	6 × 10 <sup>-1</sup>	1 × 10 <sup>4</sup>	1 × 10 <sup>6</sup>
<b>Bismuth (83)</b>				
Bi-205	7 × 10 <sup>-1</sup>	7 × 10 <sup>-1</sup>	1 × 10 <sup>1</sup>	1 × 10 <sup>6</sup>
Bi-206	3 × 10 <sup>-1</sup>	3 × 10 <sup>-1</sup>	1 × 10 <sup>1</sup>	1 × 10 <sup>5</sup>
Bi-207	7 × 10 <sup>-1</sup>	7 × 10 <sup>-1</sup>	1 × 10 <sup>1</sup>	1 × 10 <sup>6</sup>
Bi-210	1 × 10 <sup>0</sup>	6 × 10 <sup>-1</sup>	1 × 10 <sup>3</sup>	1 × 10 <sup>6</sup>
Bi-210m (a)	6 × 10 <sup>-1</sup>	2 × 10 <sup>-2</sup>	1 × 10 <sup>1</sup>	1 × 10 <sup>5</sup>
Bi-212 (a)	7 × 10 <sup>-1</sup>	6 × 10 <sup>-1</sup>	1 × 10 <sup>1</sup> (b)	1 × 10 <sup>5</sup> (b)
<b>Berkelium (97)</b>				
Bk-247	8 × 10 <sup>0</sup>	8 × 10 <sup>-4</sup>	1 × 10 <sup>0</sup>	1 × 10 <sup>4</sup>
Bk-249 (a)	4 × 10 <sup>1</sup>	3 × 10 <sup>-1</sup>	1 × 10 <sup>3</sup>	1 × 10 <sup>6</sup>
<b>Bromine (35)</b>				
Br-76	4 × 10 <sup>-1</sup>	4 × 10 <sup>-1</sup>	1 × 10 <sup>1</sup>	1 × 10 <sup>5</sup>
Br-77	3 × 10 <sup>0</sup>	3 × 10 <sup>0</sup>	1 × 10 <sup>2</sup>	1 × 10 <sup>6</sup>
Br-82	4 × 10 <sup>-1</sup>	4 × 10 <sup>-1</sup>	1 × 10 <sup>1</sup>	1 × 10 <sup>6</sup>
<b>Carbon (6)</b>				
C-11	1 × 10 <sup>0</sup>	6 × 10 <sup>-1</sup>	1 × 10 <sup>1</sup>	1 × 10 <sup>6</sup>
C-14	4 × 10 <sup>1</sup>	3 × 10 <sup>0</sup>	1 × 10 <sup>4</sup>	1 × 10 <sup>7</sup>
<b>Calcium (20)</b>				
Ca-41	Unlimited	Unlimited	1 × 10 <sup>5</sup>	1 × 10 <sup>7</sup>
Ca-45	4 × 10 <sup>1</sup>	1 × 10 <sup>0</sup>	1 × 10 <sup>4</sup>	1 × 10 <sup>7</sup>
Ca-47 (a)	3 × 10 <sup>0</sup>	3 × 10 <sup>-1</sup>	1 × 10 <sup>1</sup>	1 × 10 <sup>6</sup>
<b>Cadmium (48)</b>				
Cd-109	3 × 10 <sup>1</sup>	2 × 10 <sup>0</sup>	1 × 10 <sup>4</sup>	1 × 10 <sup>6</sup>
Cd-113m	4 × 10 <sup>1</sup>	5 × 10 <sup>-1</sup>	1 × 10 <sup>3</sup>	1 × 10 <sup>6</sup>
Cd-115 (a)	3 × 10 <sup>0</sup>	4 × 10 <sup>-1</sup>	1 × 10 <sup>2</sup>	1 × 10 <sup>6</sup>
Cd-115m	5 × 10 <sup>-1</sup>	5 × 10 <sup>-1</sup>	1 × 10 <sup>3</sup>	1 × 10 <sup>6</sup>
<b>Cerium (58)</b>				
Ce-139	7 × 10 <sup>0</sup>	2 × 10 <sup>0</sup>	1 × 10 <sup>2</sup>	1 × 10 <sup>6</sup>
Ce-141	2 × 10 <sup>1</sup>	6 × 10 <sup>-1</sup>	1 × 10 <sup>2</sup>	1 × 10 <sup>7</sup>
Ce-143	9 × 10 <sup>-1</sup>	6 × 10 <sup>-1</sup>	1 × 10 <sup>2</sup>	1 × 10 <sup>6</sup>
Ce-144 (a)	2 × 10 <sup>-1</sup>	2 × 10 <sup>-1</sup>	1 × 10 <sup>2</sup> (b)	1 × 10 <sup>5</sup> (b)
<b>Californium (98)</b>				
Cf-248	4 × 10 <sup>1</sup>	6 × 10 <sup>-3</sup>	1 × 10 <sup>1</sup>	1 × 10 <sup>4</sup>
Cf-249	3 × 10 <sup>0</sup>	8 × 10 <sup>-4</sup>	1 × 10 <sup>0</sup>	1 × 10 <sup>3</sup>
Cf-250	2 × 10 <sup>1</sup>	2 × 10 <sup>-3</sup>	1 × 10 <sup>1</sup>	1 × 10 <sup>4</sup>
Cf-251	7 × 10 <sup>0</sup>	7 × 10 <sup>-4</sup>	1 × 10 <sup>0</sup>	1 × 10 <sup>3</sup>
Cf-252	1 × 10 <sup>-1</sup>	3 × 10 <sup>-3</sup>	1 × 10 <sup>1</sup>	1 × 10 <sup>4</sup>
Cf-253 (a)	4 × 10 <sup>1</sup>	4 × 10 <sup>-2</sup>	1 × 10 <sup>2</sup>	1 × 10 <sup>5</sup>
Cf-254	1 × 10 <sup>-3</sup>	1 × 10 <sup>-3</sup>	1 × 10 <sup>0</sup>	1 × 10 <sup>3</sup>
<b>Chlorine (17)</b>				
Cl-36	1 × 10 <sup>1</sup>	6 × 10 <sup>-1</sup>	1 × 10 <sup>4</sup>	1 × 10 <sup>6</sup>
Cl-38	2 × 10 <sup>-1</sup>	2 × 10 <sup>-1</sup>	1 × 10 <sup>1</sup>	1 × 10 <sup>5</sup>
<b>Curium (96)</b>				
Cm-240	4 × 10 <sup>1</sup>	2 × 10 <sup>-2</sup>	1 × 10 <sup>2</sup>	1 × 10 <sup>5</sup>
Cm-241	2 × 10 <sup>0</sup>	1 × 10 <sup>0</sup>	1 × 10 <sup>2</sup>	1 × 10 <sup>6</sup>
Cm-242	4 × 10 <sup>1</sup>	1 × 10 <sup>-2</sup>	1 × 10 <sup>2</sup>	1 × 10 <sup>5</sup>
Cm-243	9 × 10 <sup>0</sup>	1 × 10 <sup>-3</sup>	1 × 10 <sup>0</sup>	1 × 10 <sup>4</sup>
Cm-244	2 × 10 <sup>1</sup>	2 × 10 <sup>-3</sup>	1 × 10 <sup>1</sup>	1 × 10 <sup>4</sup>

Radionuclide (atomic number)	A <sub>1</sub> (TBq)	A <sub>2</sub> (TBq)	Activity concentration for exempt material (Bq/g)	Activity limit for an exempt consignment (Bq)
Cm-245	9 × 10 <sup>0</sup>	9 × 10 <sup>-4</sup>	1 × 10 <sup>0</sup>	1 × 10 <sup>3</sup>
Cm-246	9 × 10 <sup>0</sup>	9 × 10 <sup>-4</sup>	1 × 10 <sup>0</sup>	1 × 10 <sup>3</sup>
Cm-247 (a)	3 × 10 <sup>0</sup>	1 × 10 <sup>-3</sup>	1 × 10 <sup>0</sup>	1 × 10 <sup>4</sup>
Cm-248	2 × 10 <sup>-2</sup>	3 × 10 <sup>-4</sup>	1 × 10 <sup>0</sup>	1 × 10 <sup>3</sup>
<b>Cobalt (27)</b>				
Co-55	5 × 10 <sup>-1</sup>	5 × 10 <sup>-1</sup>	1 × 10 <sup>1</sup>	1 × 10 <sup>6</sup>
Co-56	3 × 10 <sup>-1</sup>	3 × 10 <sup>-1</sup>	1 × 10 <sup>1</sup>	1 × 10 <sup>5</sup>
Co-57	1 × 10 <sup>1</sup>	1 × 10 <sup>1</sup>	1 × 10 <sup>2</sup>	1 × 10 <sup>6</sup>
Co-58	1 × 10 <sup>0</sup>	1 × 10 <sup>0</sup>	1 × 10 <sup>1</sup>	1 × 10 <sup>6</sup>
Co-58m	4 × 10 <sup>1</sup>	4 × 10 <sup>1</sup>	1 × 10 <sup>4</sup>	1 × 10 <sup>7</sup>
Co-60	4 × 10 <sup>-1</sup>	4 × 10 <sup>-1</sup>	1 × 10 <sup>1</sup>	1 × 10 <sup>5</sup>
<b>Chromium (24)</b>				
Cr-51	3 × 10 <sup>1</sup>	3 × 10 <sup>1</sup>	1 × 10 <sup>3</sup>	1 × 10 <sup>7</sup>
<b>Caesium (55)</b>				
Cs-129	4 × 10 <sup>0</sup>	4 × 10 <sup>0</sup>	1 × 10 <sup>2</sup>	1 × 10 <sup>5</sup>
Cs-131	3 × 10 <sup>1</sup>	3 × 10 <sup>1</sup>	1 × 10 <sup>3</sup>	1 × 10 <sup>6</sup>
Cs-132	1 × 10 <sup>0</sup>	1 × 10 <sup>0</sup>	1 × 10 <sup>1</sup>	1 × 10 <sup>5</sup>
Cs-134	7 × 10 <sup>-1</sup>	7 × 10 <sup>-1</sup>	1 × 10 <sup>1</sup>	1 × 10 <sup>4</sup>
Cs-134m	4 × 10 <sup>1</sup>	6 × 10 <sup>-1</sup>	1 × 10 <sup>3</sup>	1 × 10 <sup>5</sup>
Cs-135	4 × 10 <sup>1</sup>	1 × 10 <sup>0</sup>	1 × 10 <sup>4</sup>	1 × 10 <sup>7</sup>
Cs-136	5 × 10 <sup>-1</sup>	5 × 10 <sup>-1</sup>	1 × 10 <sup>1</sup>	1 × 10 <sup>5</sup>
Cs-137 (a)	2 × 10 <sup>0</sup>	6 × 10 <sup>-1</sup>	1 × 10 <sup>1</sup> (b)	1 × 10 <sup>4</sup> (b)
<b>Copper (29)</b>				
Cu-64	6 × 10 <sup>0</sup>	1 × 10 <sup>0</sup>	1 × 10 <sup>2</sup>	1 × 10 <sup>6</sup>
Cu-67	1 × 10 <sup>1</sup>	7 × 10 <sup>-1</sup>	1 × 10 <sup>2</sup>	1 × 10 <sup>6</sup>
<b>Dysprosium (66)</b>				
Dy-159	2 × 10 <sup>1</sup>	2 × 10 <sup>1</sup>	1 × 10 <sup>3</sup>	1 × 10 <sup>7</sup>
Dy-165	9 × 10 <sup>-1</sup>	6 × 10 <sup>-1</sup>	1 × 10 <sup>3</sup>	1 × 10 <sup>6</sup>
Dy-166 (a)	9 × 10 <sup>-1</sup>	3 × 10 <sup>-1</sup>	1 × 10 <sup>3</sup>	1 × 10 <sup>6</sup>
<b>Erbium (68)</b>				
Er-169	4 × 10 <sup>1</sup>	1 × 10 <sup>0</sup>	1 × 10 <sup>4</sup>	1 × 10 <sup>7</sup>
Er-171	8 × 10 <sup>-1</sup>	5 × 10 <sup>-1</sup>	1 × 10 <sup>2</sup>	1 × 10 <sup>6</sup>
<b>Europium (63)</b>				
Eu-147	2 × 10 <sup>0</sup>	2 × 10 <sup>0</sup>	1 × 10 <sup>2</sup>	1 × 10 <sup>6</sup>
Eu-148	5 × 10 <sup>-1</sup>	5 × 10 <sup>-1</sup>	1 × 10 <sup>1</sup>	1 × 10 <sup>6</sup>
Eu-149	2 × 10 <sup>1</sup>	2 × 10 <sup>1</sup>	1 × 10 <sup>2</sup>	1 × 10 <sup>7</sup>
Eu-150 (short-lived)	2 × 10 <sup>0</sup>	7 × 10 <sup>-1</sup>	1 × 10 <sup>3</sup>	1 × 10 <sup>6</sup>
Eu-150 (long-lived)	7 × 10 <sup>-1</sup>	7 × 10 <sup>-1</sup>	1 × 10 <sup>1</sup>	1 × 10 <sup>6</sup>
Eu-152	1 × 10 <sup>0</sup>	1 × 10 <sup>0</sup>	1 × 10 <sup>1</sup>	1 × 10 <sup>6</sup>
Eu-152m	8 × 10 <sup>-1</sup>	8 × 10 <sup>-1</sup>	1 × 10 <sup>2</sup>	1 × 10 <sup>6</sup>
Eu-154	9 × 10 <sup>-1</sup>	6 × 10 <sup>-1</sup>	1 × 10 <sup>1</sup>	1 × 10 <sup>6</sup>
Eu-155	2 × 10 <sup>1</sup>	3 × 10 <sup>0</sup>	1 × 10 <sup>2</sup>	1 × 10 <sup>7</sup>
Eu-156	7 × 10 <sup>-1</sup>	7 × 10 <sup>-1</sup>	1 × 10 <sup>1</sup>	1 × 10 <sup>6</sup>
<b>Fluorine (9)</b>				
F-18	1 × 10 <sup>0</sup>	6 × 10 <sup>-1</sup>	1 × 10 <sup>1</sup>	1 × 10 <sup>6</sup>
<b>Iron (26)</b>				
Fe-52 (a)	3 × 10 <sup>-1</sup>	3 × 10 <sup>-1</sup>	1 × 10 <sup>1</sup>	1 × 10 <sup>6</sup>
Fe-55	4 × 10 <sup>1</sup>	4 × 10 <sup>1</sup>	1 × 10 <sup>4</sup>	1 × 10 <sup>6</sup>
Fe-59	9 × 10 <sup>-1</sup>	9 × 10 <sup>-1</sup>	1 × 10 <sup>1</sup>	1 × 10 <sup>6</sup>
Fe-60 (a)	4 × 10 <sup>1</sup>	2 × 10 <sup>-1</sup>	1 × 10 <sup>2</sup>	1 × 10 <sup>5</sup>
<b>Gallium (31)</b>				
Ga-67	7 × 10 <sup>0</sup>	3 × 10 <sup>0</sup>	1 × 10 <sup>2</sup>	1 × 10 <sup>6</sup>
Ga-68	5 × 10 <sup>-1</sup>	5 × 10 <sup>-1</sup>	1 × 10 <sup>1</sup>	1 × 10 <sup>5</sup>
Ga-72	4 × 10 <sup>-1</sup>	4 × 10 <sup>-1</sup>	1 × 10 <sup>1</sup>	1 × 10 <sup>5</sup>
<b>Gadolinium (64)</b>				
Gd-146 (a)	5 × 10 <sup>-1</sup>	5 × 10 <sup>-1</sup>	1 × 10 <sup>1</sup>	1 × 10 <sup>6</sup>
Gd-148	2 × 10 <sup>1</sup>	2 × 10 <sup>-3</sup>	1 × 10 <sup>1</sup>	1 × 10 <sup>4</sup>
Gd-153	1 × 10 <sup>1</sup>	9 × 10 <sup>0</sup>	1 × 10 <sup>2</sup>	1 × 10 <sup>7</sup>
Gd-159	3 × 10 <sup>0</sup>	6 × 10 <sup>-1</sup>	1 × 10 <sup>3</sup>	1 × 10 <sup>6</sup>

## Part 2 – Classification

Radionuclide (atomic number)	A <sub>1</sub> (TBq)	A <sub>2</sub> (TBq)	Activity concentration for exempt material (Bq/g)	Activity limit for an exempt consignment (Bq)
<b>Germanium (32)</b>				
Ge-68 (a)	5 × 10 <sup>-1</sup>	5 × 10 <sup>-1</sup>	1 × 10 <sup>1</sup>	1 × 10 <sup>5</sup>
Ge-71	4 × 10 <sup>1</sup>	4 × 10 <sup>1</sup>	1 × 10 <sup>4</sup>	1 × 10 <sup>8</sup>
Ge-77	3 × 10 <sup>-1</sup>	3 × 10 <sup>-1</sup>	1 × 10 <sup>1</sup>	1 × 10 <sup>5</sup>
<b>Hafnium (72)</b>				
Hf-172 (a)	6 × 10 <sup>-1</sup>	6 × 10 <sup>-1</sup>	1 × 10 <sup>1</sup>	1 × 10 <sup>6</sup>
Hf-175	3 × 10 <sup>0</sup>	3 × 10 <sup>0</sup>	1 × 10 <sup>2</sup>	1 × 10 <sup>6</sup>
Hf-181	2 × 10 <sup>0</sup>	5 × 10 <sup>-1</sup>	1 × 10 <sup>1</sup>	1 × 10 <sup>6</sup>
Hf-182	Unlimited	Unlimited	1 × 10 <sup>2</sup>	1 × 10 <sup>6</sup>
<b>Mercury (80)</b>				
Hg-194 (a)	1 × 10 <sup>0</sup>	1 × 10 <sup>0</sup>	1 × 10 <sup>1</sup>	1 × 10 <sup>6</sup>
Hg-195m (a)	3 × 10 <sup>0</sup>	7 × 10 <sup>-1</sup>	1 × 10 <sup>2</sup>	1 × 10 <sup>6</sup>
Hg-197	2 × 10 <sup>1</sup>	1 × 10 <sup>1</sup>	1 × 10 <sup>2</sup>	1 × 10 <sup>7</sup>
Hg-197m	1 × 10 <sup>1</sup>	4 × 10 <sup>-1</sup>	1 × 10 <sup>2</sup>	1 × 10 <sup>6</sup>
Hg-203	5 × 10 <sup>0</sup>	1 × 10 <sup>0</sup>	1 × 10 <sup>2</sup>	1 × 10 <sup>5</sup>
<b>Holmium (67)</b>				
Ho-166	4 × 10 <sup>-1</sup>	4 × 10 <sup>-1</sup>	1 × 10 <sup>3</sup>	1 × 10 <sup>5</sup>
Ho-166m	6 × 10 <sup>-1</sup>	5 × 10 <sup>-1</sup>	1 × 10 <sup>1</sup>	1 × 10 <sup>6</sup>
<b>Iodine (53)</b>				
I-123	6 × 10 <sup>0</sup>	3 × 10 <sup>0</sup>	1 × 10 <sup>2</sup>	1 × 10 <sup>7</sup>
I-124	1 × 10 <sup>0</sup>	1 × 10 <sup>0</sup>	1 × 10 <sup>1</sup>	1 × 10 <sup>6</sup>
I-125	2 × 10 <sup>1</sup>	3 × 10 <sup>0</sup>	1 × 10 <sup>3</sup>	1 × 10 <sup>6</sup>
I-126	2 × 10 <sup>0</sup>	1 × 10 <sup>0</sup>	1 × 10 <sup>2</sup>	1 × 10 <sup>6</sup>
I-129	Unlimited	Unlimited	1 × 10 <sup>2</sup>	1 × 10 <sup>5</sup>
I-131	3 × 10 <sup>0</sup>	7 × 10 <sup>-1</sup>	1 × 10 <sup>2</sup>	1 × 10 <sup>6</sup>
I-132	4 × 10 <sup>-1</sup>	4 × 10 <sup>-1</sup>	1 × 10 <sup>1</sup>	1 × 10 <sup>5</sup>
I-133	7 × 10 <sup>-1</sup>	6 × 10 <sup>-1</sup>	1 × 10 <sup>1</sup>	1 × 10 <sup>6</sup>
I-134	3 × 10 <sup>-1</sup>	3 × 10 <sup>-1</sup>	1 × 10 <sup>1</sup>	1 × 10 <sup>5</sup>
I-135 (a)	6 × 10 <sup>-1</sup>	6 × 10 <sup>-1</sup>	1 × 10 <sup>1</sup>	1 × 10 <sup>6</sup>
<b>Iridium (49)</b>				
Ir-111	3 × 10 <sup>0</sup>	3 × 10 <sup>0</sup>	1 × 10 <sup>2</sup>	1 × 10 <sup>6</sup>
Ir-113m	4 × 10 <sup>0</sup>	2 × 10 <sup>0</sup>	1 × 10 <sup>2</sup>	1 × 10 <sup>6</sup>
Ir-114m (a)	1 × 10 <sup>1</sup>	5 × 10 <sup>-1</sup>	1 × 10 <sup>2</sup>	1 × 10 <sup>6</sup>
Ir-115m	7 × 10 <sup>0</sup>	1 × 10 <sup>0</sup>	1 × 10 <sup>2</sup>	1 × 10 <sup>6</sup>
<b>Iridium (77)</b>				
Ir-189 (a)	1 × 10 <sup>1</sup>	1 × 10 <sup>1</sup>	1 × 10 <sup>2</sup>	1 × 10 <sup>7</sup>
Ir-190	7 × 10 <sup>-1</sup>	7 × 10 <sup>-1</sup>	1 × 10 <sup>1</sup>	1 × 10 <sup>6</sup>
Ir-192	1 × 10 <sup>0</sup> (c)	6 × 10 <sup>-1</sup>	1 × 10 <sup>1</sup>	1 × 10 <sup>4</sup>
Ir-194	3 × 10 <sup>-1</sup>	3 × 10 <sup>-1</sup>	1 × 10 <sup>2</sup>	1 × 10 <sup>5</sup>
<b>Potassium (19)</b>				
K-40	9 × 10 <sup>-1</sup>	9 × 10 <sup>-1</sup>	1 × 10 <sup>2</sup>	1 × 10 <sup>6</sup>
K-42	2 × 10 <sup>-1</sup>	2 × 10 <sup>-1</sup>	1 × 10 <sup>2</sup>	1 × 10 <sup>6</sup>
K-43	7 × 10 <sup>-1</sup>	6 × 10 <sup>-1</sup>	1 × 10 <sup>1</sup>	1 × 10 <sup>6</sup>
<b>Krypton (36)</b>				
Kr-79	4 × 10 <sup>0</sup>	2 × 10 <sup>0</sup>	1 × 10 <sup>3</sup>	1 × 10 <sup>5</sup>
Kr-81	4 × 10 <sup>1</sup>	4 × 10 <sup>1</sup>	1 × 10 <sup>4</sup>	1 × 10 <sup>7</sup>
Kr-85	1 × 10 <sup>1</sup>	1 × 10 <sup>1</sup>	1 × 10 <sup>5</sup>	1 × 10 <sup>4</sup>
Kr-85m	8 × 10 <sup>0</sup>	3 × 10 <sup>0</sup>	1 × 10 <sup>3</sup>	1 × 10 <sup>10</sup>
Kr-87	2 × 10 <sup>-1</sup>	2 × 10 <sup>-1</sup>	1 × 10 <sup>2</sup>	1 × 10 <sup>9</sup>
<b>Lanthanum (57)</b>				
La-137	3 × 10 <sup>1</sup>	6 × 10 <sup>0</sup>	1 × 10 <sup>3</sup>	1 × 10 <sup>7</sup>
La-140	4 × 10 <sup>-1</sup>	4 × 10 <sup>-1</sup>	1 × 10 <sup>1</sup>	1 × 10 <sup>5</sup>
<b>Lutetium (71)</b>				
Lu-172	6 × 10 <sup>-1</sup>	6 × 10 <sup>-1</sup>	1 × 10 <sup>1</sup>	1 × 10 <sup>6</sup>
Lu-173	8 × 10 <sup>0</sup>	8 × 10 <sup>0</sup>	1 × 10 <sup>2</sup>	1 × 10 <sup>7</sup>
Lu-174	9 × 10 <sup>0</sup>	9 × 10 <sup>0</sup>	1 × 10 <sup>2</sup>	1 × 10 <sup>7</sup>
Lu-174m	2 × 10 <sup>1</sup>	1 × 10 <sup>1</sup>	1 × 10 <sup>2</sup>	1 × 10 <sup>7</sup>
Lu-177	3 × 10 <sup>1</sup>	7 × 10 <sup>-1</sup>	1 × 10 <sup>3</sup>	1 × 10 <sup>7</sup>

Radionuclide (atomic number)	A <sub>1</sub> (TBq)	A <sub>2</sub> (TBq)	Activity concentration for exempt material (Bq/g)	Activity limit for an exempt consignment (Bq)
<b>Magnesium (12)</b>				
Mg-28 (a)	3 × 10 <sup>-1</sup>	3 × 10 <sup>-1</sup>	1 × 10 <sup>1</sup>	1 × 10 <sup>5</sup>
<b>Manganese (25)</b>				
Mn-52	3 × 10 <sup>-1</sup>	3 × 10 <sup>-1</sup>	1 × 10 <sup>1</sup>	1 × 10 <sup>5</sup>
Mn-53	Unlimited	Unlimited	1 × 10 <sup>4</sup>	1 × 10 <sup>9</sup>
Mn-54	1 × 10 <sup>0</sup>	1 × 10 <sup>0</sup>	1 × 10 <sup>1</sup>	1 × 10 <sup>6</sup>
Mn-56	3 × 10 <sup>-1</sup>	3 × 10 <sup>-1</sup>	1 × 10 <sup>1</sup>	1 × 10 <sup>5</sup>
<b>Molybdenum (42)</b>				
Mo-93	4 × 10 <sup>1</sup>	2 × 10 <sup>1</sup>	1 × 10 <sup>3</sup>	1 × 10 <sup>8</sup>
Mo-99 (a)	1 × 10 <sup>0</sup>	6 × 10 <sup>-1</sup>	1 × 10 <sup>2</sup>	1 × 10 <sup>6</sup>
<b>Nitrogen (7)</b>				
N-13	9 × 10 <sup>-1</sup>	6 × 10 <sup>-1</sup>	1 × 10 <sup>2</sup>	1 × 10 <sup>9</sup>
<b>Sodium (11)</b>				
Na-22	5 × 10 <sup>-1</sup>	5 × 10 <sup>-1</sup>	1 × 10 <sup>1</sup>	1 × 10 <sup>6</sup>
Na-24	2 × 10 <sup>-1</sup>	2 × 10 <sup>-1</sup>	1 × 10 <sup>1</sup>	1 × 10 <sup>5</sup>
<b>Niobium (41)</b>				
Nb-93m	4 × 10 <sup>1</sup>	3 × 10 <sup>1</sup>	1 × 10 <sup>4</sup>	1 × 10 <sup>7</sup>
Nb-94	7 × 10 <sup>-1</sup>	7 × 10 <sup>-1</sup>	1 × 10 <sup>1</sup>	1 × 10 <sup>6</sup>
Nb-95	1 × 10 <sup>0</sup>	1 × 10 <sup>0</sup>	1 × 10 <sup>1</sup>	1 × 10 <sup>6</sup>
Nb-97	9 × 10 <sup>-1</sup>	6 × 10 <sup>-1</sup>	1 × 10 <sup>1</sup>	1 × 10 <sup>6</sup>
<b>Neodymium (60)</b>				
Nd-147	6 × 10 <sup>0</sup>	6 × 10 <sup>-1</sup>	1 × 10 <sup>2</sup>	1 × 10 <sup>5</sup>
Nd-149	6 × 10 <sup>-1</sup>	5 × 10 <sup>-1</sup>	1 × 10 <sup>2</sup>	1 × 10 <sup>6</sup>
<b>Nickel (28)</b>				
Ni-59	Unlimited	Unlimited	1 × 10 <sup>4</sup>	1 × 10 <sup>8</sup>
Ni-63	4 × 10 <sup>1</sup>	3 × 10 <sup>1</sup>	1 × 10 <sup>5</sup>	1 × 10 <sup>8</sup>
Ni-65	4 × 10 <sup>-1</sup>	4 × 10 <sup>-1</sup>	1 × 10 <sup>1</sup>	1 × 10 <sup>5</sup>
<b>Neptunium (93)</b>				
Np-235	4 × 10 <sup>1</sup>	4 × 10 <sup>1</sup>	1 × 10 <sup>3</sup>	1 × 10 <sup>7</sup>
Np-236 (short-lived)	2 × 10 <sup>3</sup>	2 × 10 <sup>0</sup>	1 × 10 <sup>3</sup>	1 × 10 <sup>7</sup>
Np-236 (long-lived)	9 × 10 <sup>0</sup>	2 × 10 <sup>-2</sup>	1 × 10 <sup>2</sup>	1 × 10 <sup>5</sup>
Np-237	2 × 10 <sup>1</sup>	2 × 10 <sup>-3</sup>	1 × 10 <sup>0</sup> (b)	1 × 10 <sup>3</sup> (b)
Np-239	7 × 10 <sup>0</sup>	4 × 10 <sup>-1</sup>	1 × 10 <sup>2</sup>	1 × 10 <sup>7</sup>
<b>Osmium (76)</b>				
Os-185	1 × 10 <sup>0</sup>	1 × 10 <sup>0</sup>	1 × 10 <sup>1</sup>	1 × 10 <sup>6</sup>
Os-191	1 × 10 <sup>1</sup>	2 × 10 <sup>0</sup>	1 × 10 <sup>2</sup>	1 × 10 <sup>7</sup>
Os-191m	4 × 10 <sup>1</sup>	3 × 10 <sup>1</sup>	1 × 10 <sup>3</sup>	1 × 10 <sup>7</sup>
Os-193	2 × 10 <sup>0</sup>	6 × 10 <sup>-1</sup>	1 × 10 <sup>2</sup>	1 × 10 <sup>6</sup>
Os-194 (a)	3 × 10 <sup>-1</sup>	3 × 10 <sup>-1</sup>	1 × 10 <sup>2</sup>	1 × 10 <sup>5</sup>
<b>Phosphorus (15)</b>				
P-32	5 × 10 <sup>-1</sup>	5 × 10 <sup>-1</sup>	1 × 10 <sup>3</sup>	1 × 10 <sup>5</sup>
P-33	4 × 10 <sup>1</sup>	1 × 10 <sup>0</sup>	1 × 10 <sup>5</sup>	1 × 10 <sup>8</sup>
<b>Protactinium (91)</b>				
Pa-230 (a)	2 × 10 <sup>0</sup>	7 × 10 <sup>-2</sup>	1 × 10 <sup>1</sup>	1 × 10 <sup>6</sup>
Pa-231	4 × 10 <sup>0</sup>	4 × 10 <sup>-4</sup>	1 × 10 <sup>0</sup>	1 × 10 <sup>3</sup>
Pa-233	5 × 10 <sup>0</sup>	7 × 10 <sup>-1</sup>	1 × 10 <sup>2</sup>	1 × 10 <sup>7</sup>
<b>Lead (82)</b>				
Pb-201	1 × 10 <sup>0</sup>	1 × 10 <sup>0</sup>	1 × 10 <sup>1</sup>	1 × 10 <sup>6</sup>
Pb-202	4 × 10 <sup>1</sup>	2 × 10 <sup>1</sup>	1 × 10 <sup>3</sup>	1 × 10 <sup>6</sup>
Pb-203	4 × 10 <sup>0</sup>	3 × 10 <sup>0</sup>	1 × 10 <sup>2</sup>	1 × 10 <sup>6</sup>
Pb-205	Unlimited	Unlimited	1 × 10 <sup>4</sup>	1 × 10 <sup>7</sup>
Pb-210 (a)	1 × 10 <sup>0</sup>	5 × 10 <sup>-2</sup>	1 × 10 <sup>1</sup> (b)	1 × 10 <sup>4</sup> (b)
Pb-212 (a)	7 × 10 <sup>-1</sup>	2 × 10 <sup>-1</sup>	1 × 10 <sup>1</sup> (b)	1 × 10 <sup>5</sup> (b)
<b>Palladium (46)</b>				
Pd-103 (a)	4 × 10 <sup>1</sup>	4 × 10 <sup>1</sup>	1 × 10 <sup>3</sup>	1 × 10 <sup>8</sup>
Pd-107	Unlimited	Unlimited	1 × 10 <sup>5</sup>	1 × 10 <sup>8</sup>
Pd-109	2 × 10 <sup>0</sup>	5 × 10 <sup>-1</sup>	1 × 10 <sup>3</sup>	1 × 10 <sup>6</sup>
<b>Promethium (61)</b>				
Pm-143	3 × 10 <sup>0</sup>	3 × 10 <sup>0</sup>	1 × 10 <sup>2</sup>	1 × 10 <sup>5</sup>

## Part 2 – Classification

Radionuclide (atomic number)	A <sub>1</sub> (TBq)	A <sub>2</sub> (TBq)	Activity concentration for exempt material (Bq/g)	Activity limit for an exempt consignment (Bq)
Pm-144	$7 \times 10^{-1}$	$7 \times 10^{-1}$	$1 \times 10^1$	$1 \times 10^6$
Pm-145	$3 \times 10^1$	$1 \times 10^1$	$1 \times 10^3$	$1 \times 10^7$
Pm-147	$4 \times 10^1$	$2 \times 10^0$	$1 \times 10^4$	$1 \times 10^7$
Pm-148m (a)	$8 \times 10^{-1}$	$7 \times 10^{-1}$	$1 \times 10^1$	$1 \times 10^6$
Pm-149	$2 \times 10^0$	$6 \times 10^{-1}$	$1 \times 10^3$	$1 \times 10^6$
Pm-151	$2 \times 10^0$	$6 \times 10^{-1}$	$1 \times 10^2$	$1 \times 10^6$
<b>Polonium (84)</b>				
Po-210	$4 \times 10^1$	$2 \times 10^{-2}$	$1 \times 10^1$	$1 \times 10^4$
<b>Praseodymium (59)</b>				
Pr-142	$4 \times 10^{-1}$	$4 \times 10^{-1}$	$1 \times 10^2$	$1 \times 10^5$
Pr-143	$3 \times 10^0$	$6 \times 10^{-1}$	$1 \times 10^4$	$1 \times 10^6$
<b>Platinum (78)</b>				
Pt-188 (a)	$1 \times 10^0$	$8 \times 10^{-1}$	$1 \times 10^1$	$1 \times 10^6$
Pt-191	$4 \times 10^0$	$3 \times 10^0$	$1 \times 10^2$	$1 \times 10^6$
Pt-193	$4 \times 10^1$	$4 \times 10^1$	$1 \times 10^4$	$1 \times 10^7$
Pt-193m	$4 \times 10^1$	$5 \times 10^{-1}$	$1 \times 10^3$	$1 \times 10^7$
Pt-195m	$1 \times 10^1$	$5 \times 10^{-1}$	$1 \times 10^2$	$1 \times 10^6$
Pt-197	$2 \times 10^1$	$6 \times 10^{-1}$	$1 \times 10^3$	$1 \times 10^6$
Pt-197m	$1 \times 10^1$	$6 \times 10^{-1}$	$1 \times 10^2$	$1 \times 10^6$
<b>Plutonium (94)</b>				
Pu-236	$3 \times 10^1$	$3 \times 10^{-3}$	$1 \times 10^1$	$1 \times 10^4$
Pu-237	$2 \times 10^1$	$2 \times 10^1$	$1 \times 10^3$	$1 \times 10^7$
Pu-238	$1 \times 10^1$	$1 \times 10^{-3}$	$1 \times 10^0$	$1 \times 10^4$
Pu-239	$1 \times 10^1$	$1 \times 10^{-3}$	$1 \times 10^0$	$1 \times 10^4$
Pu-240	$1 \times 10^1$	$1 \times 10^{-3}$	$1 \times 10^0$	$1 \times 10^3$
Pu-241 (a)	$4 \times 10^1$	$6 \times 10^{-2}$	$1 \times 10^2$	$1 \times 10^5$
Pu-242	$1 \times 10^1$	$1 \times 10^{-3}$	$1 \times 10^0$	$1 \times 10^4$
Pu-244 (a)	$4 \times 10^{-1}$	$1 \times 10^{-3}$	$1 \times 10^0$	$1 \times 10^4$
<b>Radium (88)</b>				
Ra-223 (a)	$4 \times 10^{-1}$	$7 \times 10^{-3}$	$1 \times 10^2$ (b)	$1 \times 10^5$ (b)
Ra-224 (a)	$4 \times 10^{-1}$	$2 \times 10^{-2}$	$1 \times 10^1$ (b)	$1 \times 10^5$ (b)
Ra-225 (a)	$2 \times 10^{-1}$	$4 \times 10^{-3}$	$1 \times 10^2$	$1 \times 10^5$
Ra-226 (a)	$2 \times 10^{-1}$	$3 \times 10^{-3}$	$1 \times 10^1$ (b)	$1 \times 10^4$ (b)
Ra-228 (a)	$6 \times 10^{-1}$	$2 \times 10^{-2}$	$1 \times 10^1$ (b)	$1 \times 10^5$ (b)
<b>Rubidium (37)</b>				
Rb-81	$2 \times 10^0$	$8 \times 10^{-1}$	$1 \times 10^1$	$1 \times 10^6$
Rb-83 (a)	$2 \times 10^0$	$2 \times 10^0$	$1 \times 10^2$	$1 \times 10^6$
Rb-84	$1 \times 10^0$	$1 \times 10^0$	$1 \times 10^1$	$1 \times 10^6$
Rb-86	$5 \times 10^{-1}$	$5 \times 10^{-1}$	$1 \times 10^2$	$1 \times 10^5$
Rb-87	Unlimited	Unlimited	$1 \times 10^4$	$1 \times 10^7$
Rb (nat)	Unlimited	Unlimited	$1 \times 10^4$	$1 \times 10^7$
<b>Rhenium (75)</b>				
Re-184	$1 \times 10^0$	$1 \times 10^0$	$1 \times 10^1$	$1 \times 10^6$
Re-184m	$3 \times 10^0$	$1 \times 10^0$	$1 \times 10^2$	$1 \times 10^6$
Re-186	$2 \times 10^0$	$6 \times 10^{-1}$	$1 \times 10^3$	$1 \times 10^6$
Re-187	Unlimited	Unlimited	$1 \times 10^5$	$1 \times 10^9$
Re-188	$4 \times 10^{-1}$	$4 \times 10^{-1}$	$1 \times 10^2$	$1 \times 10^5$
Re-189 (a)	$3 \times 10^0$	$6 \times 10^{-1}$	$1 \times 10^2$	$1 \times 10^6$
Re (nat)	Unlimited	Unlimited	$1 \times 10^5$	$1 \times 10^9$
<b>Rhodium (45)</b>				
Rh-99	$2 \times 10^0$	$2 \times 10^0$	$1 \times 10^1$	$1 \times 10^6$
Rh-101	$4 \times 10^0$	$3 \times 10^0$	$1 \times 10^2$	$1 \times 10^7$
Rh-102	$5 \times 10^{-1}$	$5 \times 10^{-1}$	$1 \times 10^1$	$1 \times 10^6$
Rh-102m	$2 \times 10^0$	$2 \times 10^0$	$1 \times 10^2$	$1 \times 10^6$
Rh-103m	$4 \times 10^1$	$4 \times 10^1$	$1 \times 10^4$	$1 \times 10^8$
Rh-105	$1 \times 10^1$	$8 \times 10^{-1}$	$1 \times 10^2$	$1 \times 10^7$
<b>Radon (86)</b>				
Rn-222 (a)	$3 \times 10^{-1}$	$4 \times 10^{-3}$	$1 \times 10^1$ (b)	$1 \times 10^8$ (b)
<b>Ruthenium (44)</b>				

Radionuclide (atomic number)	A <sub>1</sub> (TBq)	A <sub>2</sub> (TBq)	Activity concentration for exempt material (Bq/g)	Activity limit for an exempt consignment (Bq)
Ru-97	5 × 10 <sup>0</sup>	5 × 10 <sup>0</sup>	1 × 10 <sup>2</sup>	1 × 10 <sup>7</sup>
Ru-103 (a)	2 × 10 <sup>0</sup>	2 × 10 <sup>0</sup>	1 × 10 <sup>2</sup>	1 × 10 <sup>6</sup>
Ru-105	1 × 10 <sup>0</sup>	6 × 10 <sup>-1</sup>	1 × 10 <sup>1</sup>	1 × 10 <sup>6</sup>
Ru-106 (a)	2 × 10 <sup>-1</sup>	2 × 10 <sup>-1</sup>	1 × 10 <sup>2</sup> (b)	1 × 10 <sup>5</sup> (b)
<b>Sulphur (16)</b>				
S-35	4 × 10 <sup>1</sup>	3 × 10 <sup>0</sup>	1 × 10 <sup>5</sup>	1 × 10 <sup>8</sup>
<b>Antimony (51)</b>				
Sb-122	4 × 10 <sup>-1</sup>	4 × 10 <sup>-1</sup>	1 × 10 <sup>2</sup>	1 × 10 <sup>4</sup>
Sb-124	6 × 10 <sup>-1</sup>	6 × 10 <sup>-1</sup>	1 × 10 <sup>1</sup>	1 × 10 <sup>6</sup>
Sb-125	2 × 10 <sup>0</sup>	1 × 10 <sup>0</sup>	1 × 10 <sup>2</sup>	1 × 10 <sup>6</sup>
Sb-126	4 × 10 <sup>-1</sup>	4 × 10 <sup>-1</sup>	1 × 10 <sup>1</sup>	1 × 10 <sup>5</sup>
<b>Scandium (21)</b>				
Sc-44	5 × 10 <sup>-1</sup>	5 × 10 <sup>-1</sup>	1 × 10 <sup>1</sup>	1 × 10 <sup>5</sup>
Sc-46	5 × 10 <sup>-1</sup>	5 × 10 <sup>-1</sup>	1 × 10 <sup>1</sup>	1 × 10 <sup>6</sup>
Sc-47	1 × 10 <sup>1</sup>	7 × 10 <sup>-1</sup>	1 × 10 <sup>2</sup>	1 × 10 <sup>6</sup>
Sc-48	3 × 10 <sup>-1</sup>	3 × 10 <sup>-1</sup>	1 × 10 <sup>1</sup>	1 × 10 <sup>5</sup>
<b>Selenium (34)</b>				
Se-75	3 × 10 <sup>0</sup>	3 × 10 <sup>0</sup>	1 × 10 <sup>2</sup>	1 × 10 <sup>6</sup>
Se-79	4 × 10 <sup>1</sup>	2 × 10 <sup>0</sup>	1 × 10 <sup>4</sup>	1 × 10 <sup>7</sup>
<b>Silicon (14)</b>				
Si-31	6 × 10 <sup>-1</sup>	6 × 10 <sup>-1</sup>	1 × 10 <sup>3</sup>	1 × 10 <sup>6</sup>
Si-32	4 × 10 <sup>1</sup>	5 × 10 <sup>-1</sup>	1 × 10 <sup>3</sup>	1 × 10 <sup>6</sup>
<b>Samarium (62)</b>				
Sm-145	1 × 10 <sup>1</sup>	1 × 10 <sup>1</sup>	1 × 10 <sup>2</sup>	1 × 10 <sup>7</sup>
Sm-147	Unlimited	Unlimited	1 × 10 <sup>1</sup>	1 × 10 <sup>4</sup>
Sm-151	4 × 10 <sup>1</sup>	1 × 10 <sup>1</sup>	1 × 10 <sup>4</sup>	1 × 10 <sup>8</sup>
Sm-153	9 × 10 <sup>0</sup>	6 × 10 <sup>-1</sup>	1 × 10 <sup>2</sup>	1 × 10 <sup>6</sup>
<b>Tin (50)</b>				
Sn-113 (a)	4 × 10 <sup>0</sup>	2 × 10 <sup>0</sup>	1 × 10 <sup>3</sup>	1 × 10 <sup>7</sup>
Sn-117m	7 × 10 <sup>0</sup>	4 × 10 <sup>-1</sup>	1 × 10 <sup>2</sup>	1 × 10 <sup>6</sup>
Sn-119m	4 × 10 <sup>1</sup>	3 × 10 <sup>1</sup>	1 × 10 <sup>3</sup>	1 × 10 <sup>7</sup>
Sn-121m (a)	4 × 10 <sup>1</sup>	9 × 10 <sup>-1</sup>	1 × 10 <sup>3</sup>	1 × 10 <sup>7</sup>
Sn-123	8 × 10 <sup>-1</sup>	6 × 10 <sup>-1</sup>	1 × 10 <sup>3</sup>	1 × 10 <sup>6</sup>
Sn-125	4 × 10 <sup>-1</sup>	4 × 10 <sup>-1</sup>	1 × 10 <sup>2</sup>	1 × 10 <sup>5</sup>
Sn-126 (a)	6 × 10 <sup>-1</sup>	4 × 10 <sup>-1</sup>	1 × 10 <sup>1</sup>	1 × 10 <sup>5</sup>
<b>Strontium (38)</b>				
Sr-82 (a)	2 × 10 <sup>-1</sup>	2 × 10 <sup>-1</sup>	1 × 10 <sup>1</sup>	1 × 10 <sup>5</sup>
Sr-85	2 × 10 <sup>0</sup>	2 × 10 <sup>0</sup>	1 × 10 <sup>2</sup>	1 × 10 <sup>6</sup>
Sr-85m	5 × 10 <sup>0</sup>	5 × 10 <sup>0</sup>	1 × 10 <sup>2</sup>	1 × 10 <sup>7</sup>
Sr-87m	3 × 10 <sup>0</sup>	3 × 10 <sup>0</sup>	1 × 10 <sup>2</sup>	1 × 10 <sup>6</sup>
Sr-89	6 × 10 <sup>-1</sup>	6 × 10 <sup>-1</sup>	1 × 10 <sup>3</sup>	1 × 10 <sup>6</sup>
Sr-90 (a)	3 × 10 <sup>-1</sup>	3 × 10 <sup>-1</sup>	1 × 10 <sup>2</sup> (b)	1 × 10 <sup>4</sup> (b)
Sr-91 (a)	3 × 10 <sup>-1</sup>	3 × 10 <sup>-1</sup>	1 × 10 <sup>1</sup>	1 × 10 <sup>5</sup>
Sr-92 (a)	1 × 10 <sup>0</sup>	3 × 10 <sup>-1</sup>	1 × 10 <sup>1</sup>	1 × 10 <sup>5</sup>
<b>Tritium (1)</b>				
T (H-3)	4 × 10 <sup>1</sup>	4 × 10 <sup>1</sup>	1 × 10 <sup>6</sup>	1 × 10 <sup>9</sup>
<b>Tantalum (73)</b>				
Ta-178 (long-lived)	1 × 10 <sup>0</sup>	8 × 10 <sup>-1</sup>	1 × 10 <sup>1</sup>	1 × 10 <sup>6</sup>
Ta-179	3 × 10 <sup>1</sup>	3 × 10 <sup>1</sup>	1 × 10 <sup>3</sup>	1 × 10 <sup>7</sup>
Ta-182	9 × 10 <sup>-1</sup>	5 × 10 <sup>-1</sup>	1 × 10 <sup>1</sup>	1 × 10 <sup>4</sup>
<b>Terbium (65)</b>				
Tb-157	4 × 10 <sup>1</sup>	4 × 10 <sup>1</sup>	1 × 10 <sup>4</sup>	1 × 10 <sup>7</sup>
Tb-158	1 × 10 <sup>0</sup>	1 × 10 <sup>0</sup>	1 × 10 <sup>1</sup>	1 × 10 <sup>6</sup>
Tb-160	1 × 10 <sup>0</sup>	6 × 10 <sup>-1</sup>	1 × 10 <sup>1</sup>	1 × 10 <sup>6</sup>
<b>Technetium (43)</b>				
Tc-95m (a)	2 × 10 <sup>0</sup>	2 × 10 <sup>0</sup>	1 × 10 <sup>1</sup>	1 × 10 <sup>6</sup>
Tc-96	4 × 10 <sup>-1</sup>	4 × 10 <sup>-1</sup>	1 × 10 <sup>1</sup>	1 × 10 <sup>6</sup>
Tc-96m (a)	4 × 10 <sup>-1</sup>	4 × 10 <sup>-1</sup>	1 × 10 <sup>3</sup>	1 × 10 <sup>7</sup>
Tc-97	Unlimited	Unlimited	1 × 10 <sup>3</sup>	1 × 10 <sup>8</sup>

Part 2 – Classification

Radionuclide (atomic number)	A <sub>1</sub> (TBq)	A <sub>2</sub> (TBq)	Activity concentration for exempt material (Bq/g)	Activity limit for an exempt consignment (Bq)
Tc-97m	4 × 10 <sup>1</sup>	1 × 10 <sup>0</sup>	1 × 10 <sup>3</sup>	1 × 10 <sup>7</sup>
Tc-98	8 × 10 <sup>-1</sup>	7 × 10 <sup>-1</sup>	1 × 10 <sup>1</sup>	1 × 10 <sup>6</sup>
Tc-99	4 × 10 <sup>1</sup>	9 × 10 <sup>-1</sup>	1 × 10 <sup>4</sup>	1 × 10 <sup>7</sup>
Tc-99m	1 × 10 <sup>1</sup>	4 × 10 <sup>0</sup>	1 × 10 <sup>2</sup>	1 × 10 <sup>7</sup>
<b>Tellurium (52)</b>				
Te-121	2 × 10 <sup>0</sup>	2 × 10 <sup>0</sup>	1 × 10 <sup>1</sup>	1 × 10 <sup>6</sup>
Te-121m	5 × 10 <sup>0</sup>	3 × 10 <sup>0</sup>	1 × 10 <sup>2</sup>	1 × 10 <sup>6</sup>
Te-123m	8 × 10 <sup>0</sup>	1 × 10 <sup>0</sup>	1 × 10 <sup>2</sup>	1 × 10 <sup>7</sup>
Te-125m	2 × 10 <sup>1</sup>	9 × 10 <sup>-1</sup>	1 × 10 <sup>3</sup>	1 × 10 <sup>7</sup>
Te-127	2 × 10 <sup>1</sup>	7 × 10 <sup>-1</sup>	1 × 10 <sup>3</sup>	1 × 10 <sup>6</sup>
Te-127m (a)	2 × 10 <sup>1</sup>	5 × 10 <sup>-1</sup>	1 × 10 <sup>3</sup>	1 × 10 <sup>7</sup>
Te-129	7 × 10 <sup>-1</sup>	6 × 10 <sup>-1</sup>	1 × 10 <sup>2</sup>	1 × 10 <sup>6</sup>
Te-129m (a)	8 × 10 <sup>-1</sup>	4 × 10 <sup>-1</sup>	1 × 10 <sup>3</sup>	1 × 10 <sup>6</sup>
Te-131m (a)	7 × 10 <sup>-1</sup>	5 × 10 <sup>-1</sup>	1 × 10 <sup>1</sup>	1 × 10 <sup>6</sup>
Te-132 (a)	5 × 10 <sup>-1</sup>	4 × 10 <sup>-1</sup>	1 × 10 <sup>2</sup>	1 × 10 <sup>7</sup>
<b>Thorium (90)</b>				
Th-227	1 × 10 <sup>1</sup>	5 × 10 <sup>-3</sup>	1 × 10 <sup>1</sup>	1 × 10 <sup>4</sup>
Th-228 (a)	5 × 10 <sup>-1</sup>	1 × 10 <sup>-3</sup>	1 × 10 <sup>0</sup> (b)	1 × 10 <sup>4</sup> (b)
Th-229	5 × 10 <sup>0</sup>	5 × 10 <sup>-4</sup>	1 × 10 <sup>0</sup> (b)	1 × 10 <sup>3</sup> (b)
Th-230	1 × 10 <sup>1</sup>	1 × 10 <sup>-3</sup>	1 × 10 <sup>0</sup>	1 × 10 <sup>4</sup>
Th-231	4 × 10 <sup>1</sup>	2 × 10 <sup>-2</sup>	1 × 10 <sup>3</sup>	1 × 10 <sup>7</sup>
Th-232	Unlimited	Unlimited	1 × 10 <sup>1</sup>	1 × 10 <sup>4</sup>
Th-234 (a)	3 × 10 <sup>-1</sup>	3 × 10 <sup>-1</sup>	1 × 10 <sup>3</sup> (b)	1 × 10 <sup>5</sup> (b)
Th (nat)	Unlimited	Unlimited	1 × 10 <sup>0</sup> (b)	1 × 10 <sup>3</sup> (b)
<b>Titanium (22)</b>				
Ti-44 (a)	5 × 10 <sup>-1</sup>	4 × 10 <sup>-1</sup>	1 × 10 <sup>1</sup>	1 × 10 <sup>5</sup>
<b>Thallium (81)</b>				
Tl-200	9 × 10 <sup>-1</sup>	9 × 10 <sup>-1</sup>	1 × 10 <sup>1</sup>	1 × 10 <sup>6</sup>
Tl-201	1 × 10 <sup>1</sup>	4 × 10 <sup>0</sup>	1 × 10 <sup>2</sup>	1 × 10 <sup>6</sup>
Tl-202	2 × 10 <sup>0</sup>	2 × 10 <sup>0</sup>	1 × 10 <sup>2</sup>	1 × 10 <sup>6</sup>
Tl-204	1 × 10 <sup>1</sup>	7 × 10 <sup>-1</sup>	1 × 10 <sup>4</sup>	1 × 10 <sup>4</sup>
<b>Thulium (69)</b>				
Tm-167	7 × 10 <sup>0</sup>	8 × 10 <sup>-1</sup>	1 × 10 <sup>2</sup>	1 × 10 <sup>6</sup>
Tm-170	3 × 10 <sup>0</sup>	6 × 10 <sup>-1</sup>	1 × 10 <sup>3</sup>	1 × 10 <sup>6</sup>
Tm-171	4 × 10 <sup>1</sup>	4 × 10 <sup>1</sup>	1 × 10 <sup>4</sup>	1 × 10 <sup>8</sup>
<b>Uranium (92)</b>				
U-230 (fast lung absorption) (a) (d)	4 × 10 <sup>1</sup>	1 × 10 <sup>-1</sup>	1 × 10 <sup>1</sup> (b)	1 × 10 <sup>5</sup> (b)
U-230 (medium lung absorption) (a) (e)	4 × 10 <sup>1</sup>	4 × 10 <sup>-3</sup>	1 × 10 <sup>1</sup>	1 × 10 <sup>4</sup>
U-230 (slow lung absorption) (a) (f)	3 × 10 <sup>1</sup>	3 × 10 <sup>-3</sup>	1 × 10 <sup>1</sup>	1 × 10 <sup>4</sup>
U-232 (fast lung absorption) (d)	4 × 10 <sup>1</sup>	1 × 10 <sup>-2</sup>	1 × 10 <sup>0</sup> (b)	1 × 10 <sup>3</sup> (b)
U-232 (medium lung absorption) (e)	4 × 10 <sup>1</sup>	7 × 10 <sup>-3</sup>	1 × 10 <sup>1</sup>	1 × 10 <sup>4</sup>
U-232 (slow lung absorption) (f)	1 × 10 <sup>1</sup>	1 × 10 <sup>-3</sup>	1 × 10 <sup>1</sup>	1 × 10 <sup>4</sup>
U-233 (fast lung absorption) (d)	4 × 10 <sup>1</sup>	9 × 10 <sup>-2</sup>	1 × 10 <sup>1</sup>	1 × 10 <sup>4</sup>
U-233 (medium lung absorption) (e)	4 × 10 <sup>1</sup>	2 × 10 <sup>-2</sup>	1 × 10 <sup>2</sup>	1 × 10 <sup>5</sup>
U-233 (slow lung absorption) (f)	4 × 10 <sup>1</sup>	6 × 10 <sup>-3</sup>	1 × 10 <sup>1</sup>	1 × 10 <sup>5</sup>
U-234 (fast lung absorption) (d)	4 × 10 <sup>1</sup>	9 × 10 <sup>-2</sup>	1 × 10 <sup>1</sup>	1 × 10 <sup>4</sup>
U-234 (medium lung absorption) (e)	4 × 10 <sup>1</sup>	2 × 10 <sup>-2</sup>	1 × 10 <sup>2</sup>	1 × 10 <sup>5</sup>
U-234 (slow lung absorption) (f)	4 × 10 <sup>1</sup>	6 × 10 <sup>-3</sup>	1 × 10 <sup>1</sup>	1 × 10 <sup>5</sup>
U-235 (all lung absorption types) (a) (d) (e) (f)	Unlimited	Unlimited	1 × 10 <sup>1</sup> (b)	1 × 10 <sup>4</sup> (b)
U-236 (fast lung absorption) (d)	Unlimited	Unlimited	1 × 10 <sup>1</sup>	1 × 10 <sup>4</sup>
U-236 (medium lung absorption) (e)	4 × 10 <sup>1</sup>	2 × 10 <sup>-2</sup>	1 × 10 <sup>2</sup>	1 × 10 <sup>5</sup>
U-236 (slow lung absorption) (f)	4 × 10 <sup>1</sup>	6 × 10 <sup>-3</sup>	1 × 10 <sup>1</sup>	1 × 10 <sup>4</sup>
U-238 (all lung absorption types) (d) (e) (f)	Unlimited	Unlimited	1 × 10 <sup>1</sup> (b)	1 × 10 <sup>4</sup> (b)
U (nat)	Unlimited	Unlimited	1 × 10 <sup>0</sup> (b)	1 × 10 <sup>3</sup> (b)
U (enriched to 20% or less) (g)	Unlimited	Unlimited	1 × 10 <sup>0</sup>	1 × 10 <sup>3</sup>
U (dep)	Unlimited	Unlimited	1 × 10 <sup>0</sup>	1 × 10 <sup>3</sup>



Radionuclide (atomic number)	A <sub>1</sub> (TBq)	A <sub>2</sub> (TBq)	Activity concentration for exempt material (Bq/g)	Activity limit for an exempt consignment (Bq)
<b>Vanadium (23)</b>				
V-48	4 × 10 <sup>-1</sup>	4 × 10 <sup>-1</sup>	1 × 10 <sup>1</sup>	1 × 10 <sup>5</sup>
V-49	4 × 10 <sup>1</sup>	4 × 10 <sup>1</sup>	1 × 10 <sup>4</sup>	1 × 10 <sup>7</sup>
<b>Tungsten (74)</b>				
W-178 (a)	9 × 10 <sup>0</sup>	5 × 10 <sup>0</sup>	1 × 10 <sup>1</sup>	1 × 10 <sup>6</sup>
W-181	3 × 10 <sup>1</sup>	3 × 10 <sup>1</sup>	1 × 10 <sup>3</sup>	1 × 10 <sup>7</sup>
W-185	4 × 10 <sup>1</sup>	8 × 10 <sup>-1</sup>	1 × 10 <sup>4</sup>	1 × 10 <sup>7</sup>
W-187	2 × 10 <sup>0</sup>	6 × 10 <sup>-1</sup>	1 × 10 <sup>2</sup>	1 × 10 <sup>6</sup>
W-188 (a)	4 × 10 <sup>-1</sup>	3 × 10 <sup>-1</sup>	1 × 10 <sup>2</sup>	1 × 10 <sup>5</sup>
<b>Xenon (54)</b>				
Xe-122 (a)	4 × 10 <sup>-1</sup>	4 × 10 <sup>-1</sup>	1 × 10 <sup>2</sup>	1 × 10 <sup>9</sup>
Xe-123	2 × 10 <sup>0</sup>	7 × 10 <sup>-1</sup>	1 × 10 <sup>2</sup>	1 × 10 <sup>9</sup>
Xe-127	4 × 10 <sup>0</sup>	2 × 10 <sup>0</sup>	1 × 10 <sup>3</sup>	1 × 10 <sup>5</sup>
Xe-131m	4 × 10 <sup>1</sup>	4 × 10 <sup>1</sup>	1 × 10 <sup>4</sup>	1 × 10 <sup>4</sup>
Xe-133	2 × 10 <sup>1</sup>	1 × 10 <sup>1</sup>	1 × 10 <sup>3</sup>	1 × 10 <sup>4</sup>
Xe-135	3 × 10 <sup>0</sup>	2 × 10 <sup>0</sup>	1 × 10 <sup>3</sup>	1 × 10 <sup>10</sup>
<b>Yttrium (39)</b>				
Y-87 (a)	1 × 10 <sup>0</sup>	1 × 10 <sup>0</sup>	1 × 10 <sup>1</sup>	1 × 10 <sup>6</sup>
Y-88	4 × 10 <sup>-1</sup>	4 × 10 <sup>-1</sup>	1 × 10 <sup>1</sup>	1 × 10 <sup>6</sup>
Y-90	3 × 10 <sup>-1</sup>	3 × 10 <sup>-1</sup>	1 × 10 <sup>3</sup>	1 × 10 <sup>5</sup>
Y-91	6 × 10 <sup>-1</sup>	6 × 10 <sup>-1</sup>	1 × 10 <sup>3</sup>	1 × 10 <sup>6</sup>
Y-91m	2 × 10 <sup>0</sup>	2 × 10 <sup>0</sup>	1 × 10 <sup>2</sup>	1 × 10 <sup>6</sup>
Y-92	2 × 10 <sup>-1</sup>	2 × 10 <sup>-1</sup>	1 × 10 <sup>2</sup>	1 × 10 <sup>5</sup>
Y-93	3 × 10 <sup>-1</sup>	3 × 10 <sup>-1</sup>	1 × 10 <sup>2</sup>	1 × 10 <sup>5</sup>
<b>Ytterbium (70)</b>				
Yb-169	4 × 10 <sup>0</sup>	1 × 10 <sup>0</sup>	1 × 10 <sup>2</sup>	1 × 10 <sup>7</sup>
Yb-175	3 × 10 <sup>1</sup>	9 × 10 <sup>-1</sup>	1 × 10 <sup>3</sup>	1 × 10 <sup>7</sup>
<b>Zinc (30)</b>				
Zn-65	2 × 10 <sup>0</sup>	2 × 10 <sup>0</sup>	1 × 10 <sup>1</sup>	1 × 10 <sup>6</sup>
Zn-69	3 × 10 <sup>0</sup>	6 × 10 <sup>-1</sup>	1 × 10 <sup>4</sup>	1 × 10 <sup>6</sup>
Zn-69m (a)	3 × 10 <sup>0</sup>	6 × 10 <sup>-1</sup>	1 × 10 <sup>2</sup>	1 × 10 <sup>6</sup>
<b>Zirconium (40)</b>				
Zr-88	3 × 10 <sup>0</sup>	3 × 10 <sup>0</sup>	1 × 10 <sup>2</sup>	1 × 10 <sup>6</sup>
Zr-93	Unlimited	Unlimited	1 × 10 <sup>3</sup> (b)	1 × 10 <sup>7</sup> (b)
Zr-95 (a)	2 × 10 <sup>0</sup>	8 × 10 <sup>-1</sup>	1 × 10 <sup>1</sup>	1 × 10 <sup>6</sup>
Zr-97 (a)	4 × 10 <sup>-1</sup>	4 × 10 <sup>-1</sup>	1 × 10 <sup>1</sup> (b)	1 × 10 <sup>5</sup> (b)

(a) A<sub>1</sub> and/or A<sub>2</sub> values for these parent radionuclides include contributions from daughter radionuclides with half-lives less than 10 days, as listed in the following:

Mg-28	Al-28
Ar-42	K-42
Ca-47	Sc-47
Ti-44	Sc-44
Fe-52	Mn-52m
Fe-60	Co-60m
Zn-69m	Zn-69
Ge-68	Ga-68
Rb-83	Kr-83m
Sr-82	Rb-82
Sr-90	Y-90
Sr-91	Y-91m
Sr-92	Y-92
Y-87	Sr-87m
Zr-95	Nb-95m
Zr-97	Nb-97m, Nb-97
Mo-99	Tc-99m
Tc-95m	Tc-95

## Part 2 – Classification

Tc-96m	Tc-96
Ru-103	Rh-103m
Ru-106	Rh-106
Pd-103	Rh-103m
Ag-108m	Ag-108
Ag-110m	Ag-110
Cd-115	In-115m
In-114m	In-114
Sn-113	In-113m
Sn-121m	Sn-121
Sn-126	Sb-126m
Te-118	Sb-118
Te-127m	Te-127
Te-129m	Te-129
Te-131m	Te-131
Te-132	I-132
I-135	Xe-135m
Xe-122	I-122
Cs-137	Ba-137m
Ba-131	Cs-131
Ba-140	La-140
Ce-144	Pr-144m, Pr-144
Pm-148m	Pm-148
Gd-146	Eu-146
Dy-166	Ho-166
Hf-172	Lu-172
W-178	Ta-178
W-188	Re-188
Re-189	Os-189m
Os-194	Ir-194
Ir-189	Os-189m
Pt-188	Ir-188
Hg-194	Au-194
Hg-195m	Hg-195
Pb-210	Bi-210
Pb-212	Bi-212, Tl-208, Po-212
Bi-210m	Tl-206
Bi-212	Tl-208, Po-212
At-211	Po-211
Rn-222	Po-218, Pb-214, At-218, Bi-214, Po-214
Ra-223	Rn-219, Po-215, Pb-211, Bi-211, Po-211, Tl-207
Ra-224	Rn-220, Po-216, Pb-212, Bi-212, Tl-208, Po-212
Ra-225	Ac-225, Fr-221, At-217, Bi-213, Tl-209, Po-213, Pb-209
Ra-226	Rn-222, Po-218, Pb-214, At-218, Bi-214, Po-214
Ra-228	Ac-228
Ac-225	Fr-221, At-217, Bi-213, Tl-209, Po-213, Pb-209
Ac-227	Fr-223
Th-228	Ra-224, Rn-220, Po-216, Pb-212, Bi-212, Tl-208, Po-212
Th-234	Pa-234m, Pa-234
Pa-230	Ac-226, Th-226, Fr-222, Ra-222, Rn-218, Po-214
U-230	Th-226, Ra-222, Rn-218, Po-214
U-235	Th-231
Pu-241	U-237
Pu-244	U-240, Np-240m

<b>Am-242m</b>	Am-242, Np-238
<b>Am-243</b>	Np-239
<b>Cm-247</b>	Pu-243
<b>Bk-249</b>	Am-245
<b>Cf-253</b>	Cm-249

(b) Parent nuclides and their progeny included in secular equilibrium are listed in the following:

<b>Sr-90</b>	Y-90
<b>Zr-93</b>	Nb-93m
<b>Zr-97</b>	Nb-97
<b>Ru-106</b>	Rh-106
<b>Ag-108m</b>	Ag-108
<b>Cs-137</b>	Ba-137m
<b>Ce-144</b>	Pr-144
<b>Ba-140</b>	La-140
<b>Bi-212</b>	Tl-208 (0.36), Po-212 (0.64)
<b>Pb-210</b>	Bi-210, Po-210
<b>Pb-212</b>	Bi-212, Tl-208 (0.36), Po-212 (0.64)
<b>Rn-222</b>	Po-218, Pb-214, Bi-214, Po-214
<b>Ra-223</b>	Rn-219, Po-215, Pb-211, Bi-211, Tl-207
<b>Ra-224</b>	Rn-220, Po-216, Pb-212, Bi-212, Tl-208 (0.36), Po-212 (0.64)
<b>Ra-226</b>	Rn-222, Po-218, Pb-214, Bi-214, Po-214, Pb-210, Bi-210, Po-210
<b>Ra-228</b>	Ac-228
<b>Th-228</b>	Ra-224, Rn-220, Po-216, Pb-212, Bi-212, Tl-208 (0.36), Po-212 (0.64)
<b>Th-229</b>	Ra-225, Ac-225, Fr-221, At-217, Bi-213, Po-213, Pb-209
<b>Th (nat)</b>	Ra-228, Ac-228, Th-228, Ra-224, Rn-220, Po-216, Pb-212, Bi-212, Tl-208 (0.36), Po-212 (0.64)
<b>Th-234</b>	Pa-234m
<b>U-230</b>	Th-226, Ra-222, Rn-218, Po-214
<b>U-232</b>	Th-228, Ra-224, Rn-220, Po-216, Pb-212, Bi-212, Tl-208 (0.36), Po-212 (0.64)
<b>U-235</b>	Th-231
<b>U-238</b>	Th-234, Pa-234m
<b>U (nat)</b>	Th-234, Pa-234m, U-234, Th-230, Ra-226, Rn-222, Po-218, Pb-214, Bi-214, Po-214, Pb-210, Bi-210, Po-210
<b>Np-237</b>	Pa-233
<b>Am-242m</b>	Am-242
<b>Am-243</b>	Np-239

(c) The quantity may be determined from a measurement of the rate of decay or a measurement of the radiation level at a prescribed distance from the source.

(d) These values apply only to compounds of uranium that take the chemical form of  $UF_6$ ,  $UO_2F_2$  and  $UO_2(NO_3)_2$  in both normal and accident conditions of transport.

(e) These values apply only to compounds of uranium that take the chemical form of  $UO_3$ ,  $UF_4$ ,  $UCl_4$  and hexavalent compounds in both normal and accident conditions of transport.

(f) These values apply to all compounds of uranium other than those specified in (d) and (e) above.

(g) These values apply to unirradiated uranium only.

Part 2 – Classification

2.7.2.2.2 For individual radionuclides which are not listed in table 2.7.2.2.1, the determination of the basic radionuclide values referred to in 2.7.2.2.1 shall require multilateral approval. It is permissible to use an  $A_2$  value calculated using a dose coefficient for the appropriate lung absorption type as recommended by the International Commission on Radiological Protection, if the chemical forms of each radionuclide under both normal and accident conditions of transport are taken into consideration. Alternatively, the radionuclide values in table 2.7.2.2.2 may be used without obtaining competent authority approval.

Table 2.7.2.2.2 – Basic radionuclide values for unknown radionuclides or mixtures

Radioactive contents	$A_1$ (TBq)	$A_2$ (TBq)	Activity concentration for exempt material (Bq/g)	Activity limit for exempt consignments (Bq)
Only beta or gamma emitting nuclides are known to be present	0.1	0.02	$1 \times 10^1$	$1 \times 10^4$
Alpha emitting nuclides but no neutron emitters are known to be present	0.2	$9 \times 10^{-5}$	$1 \times 10^{-1}$	$1 \times 10^3$
Neutron emitting nuclides are known to be present or no relevant data are available	0.001	$9 \times 10^{-5}$	$1 \times 10^{-1}$	$1 \times 10^3$

2.7.2.2.3 In the calculations of  $A_1$  and  $A_2$  for a radionuclide not in table 2.7.2.2.1, a single radioactive decay chain in which the radionuclides are present in their naturally occurring proportions, and in which no daughter nuclide has a half-life either longer than 10 days or longer than that of the parent nuclide, shall be considered as a single radionuclide; and the activity to be taken into account and the  $A_1$  or  $A_2$  value to be applied shall be those corresponding to the parent nuclide of that chain. In the case of radioactive decay chains in which any daughter nuclide has a half-life either longer than 10 days or greater than that of the parent nuclide, the parent and such daughter nuclides shall be considered as mixtures of different nuclides.

2.7.2.2.4 For mixtures of radionuclides, the determination of the basic radionuclide values referred to in 2.7.2.2.1 may be determined as follows:

$$X_m = \frac{1}{\sum_i \frac{f(i)}{X(i)}}$$

where:  $f(i)$  is the fraction of activity or activity concentration of radionuclide  $i$  in the mixture;  
 $X(i)$  is the appropriate value of  $A_1$  or  $A_2$ , or the activity concentration for exempt material or the activity limit for an exempt consignment, as appropriate, for the radionuclide  $i$ ; and  
 $X_m$  is the derived value of  $A_1$  or  $A_2$ , or the activity concentration for exempt material or the activity limit for an exempt consignment in the case of a mixture.

2.7.2.2.5 When the identity of each radionuclide is known but the individual activities of some of the radionuclides are not known, the radionuclides may be grouped and the lowest radionuclide value, as appropriate, for the radionuclides in each group may be used in applying the formulae in 2.7.2.2.4 and 2.7.2.4.4. Groups may be based on the total alpha activity and the total beta/gamma activity when these are known, using the lowest radionuclide values for the alpha emitters or beta/gamma emitters, respectively.

2.7.2.2.6 For individual radionuclides or for mixtures of radionuclides for which relevant data are not available, the values shown in table 2.7.2.2.2 shall be used.

2.7.2.3 Determination of other material characteristics

2.7.2.3.1 Low specific activity (LSA) material

2.7.2.3.1.1 [Reserved]

2.7.2.3.1.2 LSA material shall be in one of three groups:

- .1 LSA-I
  - (i) uranium and thorium ores and concentrates of such ores, and other ores containing naturally occurring radionuclides which are intended to be processed for the use of these radionuclides;
  - (ii) Natural uranium, depleted uranium, natural thorium or their compounds or mixtures, that are unirradiated and in solid or liquid form;
  - (iii) radioactive material for which the  $A_2$  value is unlimited, excluding fissile material not excepted under 2.7.2.3.5; or

- (iv) other radioactive material in which the activity is distributed throughout and the estimated average specific activity does not exceed 30 times the values for activity concentration specified in 2.7.2.2.1 to 2.7.2.2.6, excluding fissile material not excepted under 2.7.2.3.5;
- 2.2 LSA-II
- (i) water with tritium concentration up to 0.8 TBq/l; or
  - (ii) other material in which the activity is distributed throughout and the estimated average specific activity does not exceed  $10^{-4}A_2/g$  for solids and gases, and  $10^{-5}A_2/g$  for liquids;
- 3.3 LSA-III – Solids (e.g., consolidated wastes, activated materials), excluding powders, meeting the requirements of 2.7.2.3.1.3, in which:
- (i) the radioactive material is distributed throughout a solid or a collection of solid objects, or is essentially uniformly distributed in a solid compact binding agent (such as concrete, bitumen, ceramic, etc.);
  - (ii) the radioactive material is relatively insoluble, or it is intrinsically contained in a relatively insoluble matrix, so that, even under loss of packaging, the loss of radioactive material per package by leaching when placed in water for seven days would not exceed  $0.1A_2$ ; and
  - (iii) the estimated average specific activity of the solid, excluding any shielding material, does not exceed  $2 \times 10^{-3}A_2/g$ .
- 2.7.2.3.1.3 LSA-III material shall be a solid of such a nature that, if the entire contents of a package were subjected to the test specified in 2.7.2.3.1.4, the activity in the water would not exceed  $0.1A_2$ .
- 2.7.2.3.1.4 LSA-III material shall be tested as follows:
- A solid material sample representing the entire contents of the package shall be immersed for 7 days in water at ambient temperature. The volume of water to be used in the test shall be sufficient to ensure that at the end of the 7-day test period the free volume of the unabsorbed and unreacted water remaining shall be at least 10% of the volume of the solid test sample itself. The water shall have an initial pH of 6–8 and a maximum conductivity of 1 mS/m at 20°C. The total activity of the free volume of water shall be measured following the 7-day immersion of the test sample.
- 2.7.2.3.1.5 Demonstration of compliance with the performance standards in 2.7.2.3.1.4 shall be in accordance with 6.4.12.1 and 6.4.12.2.
- 2.7.2.3.2 **Surface contaminated object (SCO)**
- SCO is classified in one of two groups:
- 1 SCO-I: A solid object on which:
- (i) the non-fixed contamination on the accessible surface averaged over 300 cm<sup>2</sup> (or the area of the surface if less than 300 cm<sup>2</sup>) does not exceed 4 Bq/cm<sup>2</sup> for beta and gamma emitters and low-toxicity alpha emitters, or 0.4 Bq/cm<sup>2</sup> for all other alpha emitters;
  - (ii) the fixed contamination on the accessible surface averaged over 300 cm<sup>2</sup> (or the area of the surface if less than 300 cm<sup>2</sup>) does not exceed  $4 \times 10^4$  Bq/cm<sup>2</sup> for beta and gamma emitters and low-toxicity alpha emitters, or  $4 \times 10^3$  Bq/cm<sup>2</sup> for all other alpha emitters; and
  - (iii) the non-fixed contamination plus the fixed contamination on the inaccessible surface averaged over 300 cm<sup>2</sup> (or the area of the surface if less than 300 cm<sup>2</sup>) does not exceed  $4 \times 10^4$  Bq/cm<sup>2</sup> for beta and gamma emitters and low-toxicity alpha emitters, or  $4 \times 10^3$  Bq/cm<sup>2</sup> for all other alpha emitters;
- 2 SCO-II: A solid object on which either the fixed or non-fixed contamination on the surface exceeds the applicable limits specified for SCO-I in 2.7.2.3.2.1 above and on which:
- (i) the non-fixed contamination on the accessible surface averaged over 300 cm<sup>2</sup> (or the area of the surface if less than 300 cm<sup>2</sup>) does not exceed 400 Bq/cm<sup>2</sup> for beta and gamma emitters and low-toxicity alpha emitters, or 40 Bq/cm<sup>2</sup> for all other alpha emitters;
  - (ii) the fixed contamination on the accessible surface averaged over 300 cm<sup>2</sup> (or the area of the surface if less than 300 cm<sup>2</sup>) does not exceed  $8 \times 10^5$  Bq/cm<sup>2</sup> for beta and gamma emitters and low-toxicity alpha emitters, or  $8 \times 10^4$  Bq/cm<sup>2</sup> for all other alpha emitters; and
  - (iii) the non-fixed contamination plus the fixed contamination on the inaccessible surface averaged over 300 cm<sup>2</sup> (or the area of the surface if less than 300 cm<sup>2</sup>) does not exceed  $8 \times 10^5$  Bq/cm<sup>2</sup> for beta and gamma emitters and low-toxicity alpha emitters, or  $8 \times 10^4$  Bq/cm<sup>2</sup> for all other alpha emitters.
- 2.7.2.3.3 **Special form radioactive material**
- 2.7.2.3.3.1
- 1 Special form radioactive material shall have at least one dimension not less than 5 mm.
  - 2 When a sealed capsule constitutes part of the special form radioactive material, the capsule shall be so manufactured that it can be opened only by destroying it.
  - 3 The design for special form radioactive material requires unilateral approval.

**Part 2 – Classification**

---

- 2.7.2.3.3.2** Special form radioactive material shall be of such a nature or shall be so designed that, if it is subjected to the tests specified in 2.7.2.3.3.4 to 2.7.2.3.3.8, it shall meet the following requirements:
- .1 It would not break or shatter under the impact, percussion and bending tests 2.7.2.3.3.5.1, 2.7.2.3.3.5.2, 2.7.2.3.3.5.3, and 2.7.2.3.3.6.1 as applicable;
  - .2 It would not melt or disperse in the applicable heat test 2.7.2.3.3.5.4 or 2.7.2.3.3.6.2 as applicable; and
  - .3 The activity in the water from the leaching tests specified in 2.7.2.3.3.7 and 2.7.2.3.3.8 would not exceed 2 kBq; or alternatively for sealed sources, the leakage rate for the volumetric leakage assessment test specified in ISO 9978:1992 "Radiation protection – Sealed radioactive sources – Leakage test methods" would not exceed the applicable acceptance threshold acceptable to the competent authority.
- 2.7.2.3.3.3** Demonstration of compliance with the performance standards in 2.7.2.3.3.2 shall be in accordance with 6.4.12.1 and 6.4.12.2.
- 2.7.2.3.3.4** Specimens that comprise or simulate special form radioactive material shall be subjected to the impact test, the percussion test, the bending test, and the heat test specified in 2.7.2.3.3.5 or alternative tests as authorized in 2.7.2.3.3.6. A different specimen may be used for each of the tests. Following each test, a leaching assessment or volumetric leakage test shall be performed on the specimen by a method no less sensitive than the methods given in 2.7.2.3.3.7 for indispersible solid material or 2.7.2.3.3.8 for encapsulated material.
- 2.7.2.3.3.5** The relevant test methods are:
- .1 Impact test: The specimen shall drop onto the target from a height of 9 m. The target shall be as defined in 6.4.14;
  - .2 Percussion test: The specimen shall be placed on a sheet of lead which is supported by a smooth solid surface and struck by the flat face of a mild steel bar so as to cause an impact equivalent to that resulting from a free drop of 1.4 kg through 1 m. The lower part of the bar shall be 25 mm in diameter with the edges rounded off to a radius of  $(3.0 \pm 0.3)$  mm. The lead, of hardness number 3.5 to 4.5 on the Vickers scale and not more than 25 mm thick, shall cover an area greater than that covered by the specimen. A fresh surface of lead shall be used for each impact. The bar shall strike the specimen so as to cause maximum damage;
  - .3 Bending test: The test shall apply only to long, slender sources with both a minimum length of 10 cm and a length to minimum width ratio of not less than 10. The specimen shall be rigidly clamped in a horizontal position so that one half of its length protrudes from the face of the clamp. The orientation of the specimen shall be such that the specimen will suffer maximum damage when its free end is struck by the flat face of a steel bar. The bar shall strike the specimen so as to cause an impact equivalent to that resulting from a free vertical drop of 1.4 kg through 1 m. The lower part of the bar shall be 25 mm in diameter with the edges rounded off to a radius of  $(3.0 \pm 0.3)$  mm;
  - .4 Heat test: The specimen shall be heated in air to a temperature of 800°C and held at that temperature for a period of 10 minutes and shall then be allowed to cool.
- 2.7.2.3.3.6** Specimens that comprise or simulate radioactive material enclosed in a sealed capsule may be excepted from:
- .1 The tests prescribed in 2.7.2.3.3.5.1 and 2.7.2.3.3.5.2 provided the mass of the special form radioactive material:
    - (i) is less than 200 g and they are alternatively subjected to the class 4 impact test prescribed in ISO 2919:1999 "Radiation protection – Sealed radioactive sources – General requirements and classification"; or
    - (ii) is less than 500 g and they are alternatively subjected to the class 5 impact test prescribed in ISO 2919:1999 "Radiation protection – Sealed radioactive sources – General requirements and classification"; and
  - .2 The test prescribed in 2.7.2.3.3.5.4 provided they are alternatively subjected to the class 6 temperature test specified in ISO 2919:1999 "Radiation protection – Sealed radioactive sources – General requirements and classification".
- 2.7.2.3.3.7** For specimens which comprise or simulate indispersible solid material, a leaching assessment shall be performed as follows:
- .1 The specimen shall be immersed for 7 days in water at ambient temperature. The volume of water to be used in the test shall be sufficient to ensure that at the end of the 7-day test period the free volume of the unabsorbed and unreacted water remaining shall be at least 10% of the volume of the solid test sample itself. The water shall have an initial pH of 6–8 and a maximum conductivity of 1 mS/m at 20°C;
  - .2 The water with specimen shall then be heated to a temperature of  $(50 \pm 5)$ °C and maintained at this temperature for 4 hours;
  - .3 The activity of the water shall then be determined;

- .4 The specimen shall then be kept for at least 7 days in still air at not less than 30°C and relative humidity not less than 90%;
- .5 The specimen shall then be immersed in water of the same specification as in 2.7.2.3.3.7.1 above and the water with the specimen heated to (50 ± 5)°C and maintained at this temperature for 4 hours;
- .6 The activity of the water shall then be determined.

**2.7.2.3.3.8** For specimens which comprise or simulate radioactive material enclosed in a sealed capsule, either a leaching assessment or a volumetric leakage assessment shall be performed as follows:

- .1 The leaching assessment shall consist of the following steps:
  - (i) the specimen shall be immersed in water at ambient temperature. The water shall have an initial pH of 6–8 with a maximum conductivity of 1 mS/m at 20°C;
  - (ii) the water and specimen shall be heated to a temperature of (50 ± 5)°C and maintained at this temperature for 4 hours;
  - (iii) the activity of the water shall then be determined;
  - (iv) the specimen shall then be kept for at least 7 days in still air at not less than 30°C and relative humidity of not less than 90%;
  - (v) the process in (i), (ii) and (iii) shall be repeated.
- .2 The alternative volumetric leakage assessment shall comprise any of the tests prescribed in ISO 9978:1992 “Radiation protection – Sealed radioactive sources – Leakage test methods” which are acceptable to the competent authority.

**2.7.2.3.4 Low dispersible material**

**2.7.2.3.4.1** The design for low dispersible radioactive material shall require multilateral approval. Low dispersible radioactive material shall be such that the total amount of this radioactive material in a package, taking into account the provisions of 6.4.8.14, shall meet the following provisions:

- .1 The radiation level at 3 m from the unshielded radioactive material does not exceed 10 mSv/h;
- .2 If subjected to the tests specified in 6.4.20.3 and 6.4.20.4, the airborne release in gaseous and particulate forms of up to 100 µm aerodynamic equivalent diameter would not exceed 100A<sub>2</sub>. A separate specimen may be used for each test; and
- .3 If subjected to the test specified in 2.7.2.3.1.4, the activity in the water would not exceed 100A<sub>2</sub>. In the application of this test, the damaging effects of the tests specified in 2.7.2.3.4.1.2 above shall be taken into account.

**2.7.2.3.4.2** Low dispersible material shall be tested as follows:

A specimen that comprises or simulates low dispersible radioactive material shall be subjected to the enhanced thermal test specified in 6.4.20.3 and the impact test specified in 6.4.20.4. A different specimen may be used for each of the tests. Following each test, the specimen shall be subjected to the leach test specified in 2.7.2.3.1.4. After each test it shall be determined if the applicable provisions of 2.7.2.3.4.1 have been met.

**2.7.2.3.4.3** Demonstration of compliance with the performance standards in 2.7.2.3.4.1 and 2.7.2.3.4.2 shall be in accordance with 6.4.12.1 and 6.4.12.2.

**2.7.2.3.5 Fissile material**

Packages containing fissile material shall be classified under the relevant entry of table 2.7.2.1.1, the description of which includes the words “FISSILE” or “fissile-excepted”. Classification as “fissile-excepted” is allowed only if one of the conditions .1 to .4 of this paragraph is met. Only one type of exception is allowed per consignment (see also 6.4.7.2).

- .1 A mass limit per consignment, provided that the smallest external dimension of each package is not less than 10 cm, such that:

$$\frac{\text{mass of uranium-235 (g)}}{X} + \frac{\text{mass of other fissile material (g)}}{Y} < 1$$

where X and Y are the mass limits defined in table 2.7.2.3.5, provided that either:

- (i) each individual package contains not more than 15 g of fissile nuclides; for unpackaged material, this quantity limitation shall apply to the consignment being carried in or on the conveyance; or
- (ii) the fissile material is a homogeneous hydrogenous solution or mixture where the ratio of fissile nuclides to hydrogen is less than 5% by mass; or

Part 2 – Classification

(iii) there are not more than 5 g of fissile nuclides in any 10 litre volume of material.

Beryllium shall not be present in quantities exceeding 1% of the applicable consignment mass limits provided in table 2.7.2.3.5 except where the concentration of beryllium in the material does not exceed 1 gram beryllium in any 1000 grams.

Deuterium shall also not be present in quantities exceeding 1% of the applicable consignment mass limits provided in table 2.7.2.3.5 except where deuterium occurs up to natural concentration in hydrogen.

- .2 Uranium enriched in uranium-235 to a maximum of 1% by mass, and with a total plutonium and uranium-233 content not exceeding 1% of the mass of uranium-235, provided that the fissile nuclides are distributed essentially homogeneously throughout the material. In addition, if uranium-235 is present in metallic, oxide or carbide forms, it shall not form a lattice arrangement;
- .3 Liquid solutions of uranyl nitrate enriched in uranium-235 to a maximum of 2% by mass, with a total plutonium and uranium-233 content not exceeding 0.002% of the mass of uranium, and with a minimum nitrogen to uranium atomic ratio (N/U) of 2;
- .4 Plutonium containing not more than 20% of fissile nuclides by mass up to a maximum of 1 kg of plutonium per consignment. Shipments under this exception shall be under exclusive use.

Table 2.7.2.3.5 – Consignment mass limits for exceptions from the requirements for packages containing fissile material

Fissile material	Fissile material mass (g) mixed with substances having an average hydrogen density less than or equal to water	Fissile material mass (g) mixed with substances having an average hydrogen density greater than water
Uranium-235 (X)	400	290
Other fissile material (Y)	250	180

2.7.2.4 Classification of packages or unpacked material

The quantity of radioactive material in a package shall not exceed the relevant limits for the package type as specified below.

2.7.2.4.1 Classification as excepted package

2.7.2.4.1.1 Packages may be classified as excepted packages if:

- .1 They are empty packagings having contained radioactive material;
- .2 They contain instruments or articles in limited quantities as specified in table 2.7.2.4.1.2;
- .3 They contain articles manufactured of natural uranium, depleted uranium or natural thorium; or
- .4 They contain radioactive material in limited quantities as specified in table 2.7.2.4.1.2.

2.7.2.4.1.2 A package containing radioactive material may be classified as an excepted package provided that the radiation level at any point on its external surface does not exceed 5 µSv/h.

Table 2.7.2.4.1.2 – Activity limits for excepted packages

Physical state of contents	Instruments or article		Material package limits <sup>a</sup>
	Item limits <sup>a</sup>	Package limits <sup>a</sup>	
(1)	(2)	(3)	(4)
<b>Solids</b>			
special form	$10^{-2} A_1$	$A_1$	$10^{-3} A_1$
other form	$10^{-2} A_2$	$A_2$	$10^{-3} A_2$
<b>Liquids</b>	$10^{-3} A_2$	$10^{-1} A_2$	$10^{-4} A_2$
<b>Gases</b>			
tritium	$2 \times 10^{-2} A_2$	$2 \times 10^{-1} A_2$	$2 \times 10^{-2} A_2$
special form	$10^{-3} A_1$	$10^{-2} A_1$	$10^{-3} A_1$
other forms	$10^{-3} A_2$	$10^{-2} A_2$	$10^{-3} A_2$

<sup>a</sup> For mixtures of radionuclides, see 2.7.2.2.4 to 2.7.2.2.6.



- 2.7.2.4.1.3** Radioactive material which is enclosed in or is included as a component part of an instrument or other manufactured article may be classified under UN 2911, RADIOACTIVE MATERIAL, EXCEPTED PACKAGE – INSTRUMENTS or ARTICLES only if:
- .1 the radiation level at 10 cm from any point on the external surface of any unpackaged instrument or article is not greater than 0.1 mSv/h; and
  - .2 each instrument or manufactured article bears the marking “RADIOACTIVE” except:
    - (i) radioluminescent time-pieces or devices;
    - (ii) consumer products that either have received regulatory approval according to 1.5.1.4.4 or do not individually exceed the activity limit for an exempt consignment in table 2.7.2.2.1 (column 5), provided such products are transported in a package that bears the marking “RADIOACTIVE” on an internal surface in such a manner that warning of the presence of radioactive material is visible on opening the package; and
  - .3 the active material is completely enclosed by non-active components (a device performing the sole function of containing radioactive material shall not be considered to be an instrument or manufactured article); and
  - .4 the limits specified in columns 2 and 3 of table 2.7.2.4.1.2 are met for each individual item and each package, respectively.
- 2.7.2.4.1.4** Radioactive material in forms other than as specified in 2.7.2.4.1.3 and with an activity not exceeding the limits specified in column 4 of Table 2.7.2.4.1.2, may be classified under UN 2910, RADIOACTIVE MATERIAL, EXCEPTED PACKAGE – LIMITED QUANTITY OF MATERIAL provided that:
- .1 the package retains its radioactive contents under routine conditions of transport; and
  - .2 the package bears the marking “RADIOACTIVE” on an internal surface in such a manner that a warning of the presence of radioactive material is visible on opening the package.
- 2.7.2.4.1.5** An empty packaging which had previously contained radioactive material may be classified under UN 2908, RADIOACTIVE MATERIAL, EXCEPTED PACKAGE – EMPTY PACKAGING, only if:
- .1 it is in a well-maintained condition and securely closed;
  - .2 the outer surface of any uranium or thorium in its structure is covered with an inactive sheath made of metal or some other substantial material;
  - .3 the level of internal non-fixed contamination, when averaged over any 300 cm<sup>2</sup>, does not exceed:
    - (i) 400 Bq/cm<sup>2</sup> for beta and gamma emitters and low-toxicity alpha emitters; and
    - (ii) 40 Bq/cm<sup>2</sup> for all other alpha emitters; and
  - .4 any labels which may have been displayed on it in conformity with 5.2.2.1.12.1 are no longer visible.
- 2.7.2.4.1.6** Articles manufactured of natural uranium, depleted uranium or natural thorium and articles in which the sole radioactive material is unirradiated natural uranium, unirradiated depleted uranium or unirradiated natural thorium may be classified under UN 2909, RADIOACTIVE MATERIAL, EXCEPTED PACKAGE – ARTICLES MANUFACTURED FROM NATURAL URANIUM or DEPLETED URANIUM or NATURAL THORIUM, only if the outer surface of the uranium or thorium is enclosed in an inactive sheath made of metal or some other substantial material.
- 2.7.2.4.2** *Classification as Low specific activity (LSA) material*
- Radioactive material may only be classified as LSA material if the definition of LSA in 2.7.1.3 and the conditions of 2.7.2.3.1, 4.1.9.2 and 7.1.4.5.1 are met.
- 2.7.2.4.3** *Classification as Surface contaminated object (SCO)*
- Radioactive material may be classified as SCO if the definition of SCO in 2.7.1.3 and the conditions of 2.7.2.3.2, 4.1.9.2 and 7.1.4.5.1 are met.
- 2.7.2.4.4** *Classification as Type A package*
- Packages containing radioactive material may be classified as Type A packages provided that the following conditions are met:
- Type A packages shall not contain activities greater than the following:
- .1 For special form radioactive material – A<sub>1</sub>; or
  - .2 For all other radioactive material – A<sub>2</sub>.

For mixtures of radionuclides whose identities and respective activities are known, the following condition shall apply to the radioactive contents of a Type A package:

$$\sum_i \frac{B(i)}{A_1(i)} + \sum_j \frac{C(j)}{A_2(j)} \leq 1$$

where:  $B(i)$  is the activity of radionuclide  $i$  as special form radioactive material;  
 $A_1(i)$  is the  $A_1$  value for radionuclide  $i$ ;  
 $C(j)$  is the activity of radionuclide  $j$  as other than special form radioactive material; and  
 $A_2(j)$  is the  $A_2$  value for radionuclide  $j$ .

#### 2.7.2.4.5 Classification of uranium hexafluoride

Uranium hexafluoride shall only be assigned to UN No. 2977, RADIOACTIVE MATERIAL, URANIUM HEXAFLUORIDE, FISSILE, or 2978, RADIOACTIVE MATERIAL, URANIUM HEXAFLUORIDE, non-fissile or fissile – excepted.

2.7.2.4.5.1 Packages containing uranium hexafluoride shall not contain:

- .1 a mass of uranium hexafluoride different from that authorized for the package design;
- .2 a mass of uranium hexafluoride greater than a value that would lead to an ullage smaller than 5% at the maximum temperature of the package as specified for the plant systems where the package shall be used; or
- .3 uranium hexafluoride other than in solid form or at an internal pressure above atmospheric pressure when presented for transport.

#### 2.7.2.4.6 Classification as Type B(U), Type B(M) or Type C packages

2.7.2.4.6.1 Packages not otherwise classified in 2.7.2.4 (2.7.2.4.1 to 2.7.2.4.5) shall be classified in accordance with the competent authority approval certificate for the package issued by the country of origin of design.

2.7.2.4.6.2 A package may only be classified as a Type B(U) if it does not contain:

- .1 activities greater than those authorized for the package design;
- .2 radionuclides different from those authorized for the package design; or
- .3 contents in a form, or a physical or chemical state, different from those authorized for the package design

as specified in the certificate of approval.

2.7.2.4.6.3 A package may only be classified as a Type B(M) if it does not contain:

- .1 activities greater than those authorized for the package design;
- .2 radionuclides different from those authorized for the package design; or
- .3 contents in a form, or a physical or chemical state, different from those authorized for the package design,

as specified in the certificate of approval.

2.7.2.4.6.4 A package may only be classified as a Type C if it does not contain:

- .1 activities greater than those authorized for the package design;
- .2 radionuclides different from those authorized for the package design; or
- .3 contents in a form, or physical or chemical state, different from those authorized for the package design,

as specified in the certificate of approval.

#### 2.7.2.5 Special arrangements

Radioactive material shall be classified as transported under special arrangement when it is intended to be transported in accordance with 1.5.4.

## Chapter 2.8

### Class 8 – Corrosive substances

#### 2.8.1 Definition and properties

##### 2.8.1.1 Definition

*Class 8 substances (corrosive substances)* means substances which, by chemical action, will cause severe damage when in contact with living tissue or, in the case of leakage, will materially damage, or even destroy, other goods or the means of transport.

##### 2.8.1.2 Properties

2.8.1.2.1 In cases where particularly severe personal damage is to be expected, a note to that effect is made in the Dangerous Goods List in chapter 3.2 in the wording “causes (severe) burns to skin, eyes and mucous membranes”.

2.8.1.2.2 Many substances are sufficiently volatile to evolve vapour irritating to the nose and eyes. If so, this fact is mentioned in the Dangerous Goods List in chapter 3.2 in the wording “vapour irritates mucous membranes”.

2.8.1.2.3 A few substances may produce toxic gases when decomposed by very high temperatures. In these cases the statement “when involved in a fire, evolves toxic gases” appears in the Dangerous Goods List in chapter 3.2.

2.8.1.2.4 In addition to direct destructive action in contact with skin or mucous membranes, some substances in this class are toxic or harmful. Poisoning may result if they are swallowed, or if their vapour is inhaled; some of them even may penetrate the skin. Where appropriate, a statement is made to that effect in the Dangerous Goods List in chapter 3.2.

2.8.1.2.5 All substances in this class have a more or less destructive effect on materials such as metals and textiles.

2.8.1.2.5.1 In the Dangerous Goods List, the term “corrosive to most metals” means that any metal likely to be present in a ship, or in its cargo, may be attacked by the substance or its vapour.

2.8.1.2.5.2 The term “corrosive to aluminium, zinc, and tin” implies that iron or steel is not damaged in contact with the substance.

2.8.1.2.5.3 A few substances in this class can corrode glass, earthenware and other siliceous materials. Where appropriate, this is stated in the Dangerous Goods List in chapter 3.2.

2.8.1.2.6 Many substances in this class only become corrosive after having reacted with water, or with moisture in the air. This fact is indicated in the Dangerous Goods List in chapter 3.2 by the words “in the presence of moisture...”. The reaction of water with many substances is accompanied by the liberation of irritating and corrosive gases. Such gases usually become visible as fumes in the air.

2.8.1.2.7 A few substances in this class generate heat in reaction with water or organic materials, including wood, paper, fibres, some cushioning materials and certain fats and oils. Where appropriate, this is indicated in the Dangerous Goods List in chapter 3.2.

2.8.1.2.8 A substance which is designated as “stabilized” shall not be transported in the unstabilized state.

#### 2.8.2 Assignment of packing groups

2.8.2.1 Substances and preparations of class 8 are divided among the three packing groups according to their degree of hazard in transport as follows:

Packing group I: Very dangerous substances and preparations;

Packing group II: Substances and preparations presenting medium danger;

Packing group III: Substances and preparations presenting minor danger.

The packing group to which a substance has been assigned is given in the Dangerous Goods List in chapter 3.2.

Part 2 – Classification

- 2.8.2.2 Allocation of substances listed in the Dangerous Goods List in chapter 3.2 to the packing groups in class 8 has been on the basis of experience, taking into account such additional factors as inhalation risk (see 2.8.2.3) and reactivity with water (including the formation of dangerous decomposition products). New substances, including mixtures, can be assigned to packing groups on the basis of the length of time of contact necessary to produce full thickness destruction of human skin in accordance with the criteria in 2.8.2.5. Liquids, and solids which may become liquid during transport, which are judged not to cause full thickness destruction of human skin shall still be considered for their potential to cause corrosion in certain metal surfaces in accordance with the criteria in 2.8.2.5.3.2.
- 2.8.2.3 A substance or preparation meeting the criteria of class 8 and having an inhalation toxicity of dusts and mists (LC<sub>50</sub>) in the range of packing group I, but toxicity through oral ingestion or dermal contact only in the range of packing group III or less, shall be allocated to class 8 (see Note under 2.6.2.2.4.1).
- 2.8.2.4 In assigning the packing group to a substance in accordance with 2.8.2.2, account shall be taken of human experience in instances of accidental exposure. In the absence of human experience, the grouping shall be based on data obtained from experiments in accordance with OECD Test Guideline 404\* or 435†. A substance which is determined not to be corrosive in accordance with OECD Test Guideline 430‡ or 431§ may be considered not to be corrosive to skin for the purposes of this Code without further testing.
- 2.8.2.5 Packing groups are assigned to corrosive substances in accordance with the following criteria:
- .1 Packing group I is assigned to substances that cause full thickness destruction of intact skin tissue within an observation period of up to 60 minutes starting after an exposure time of 3 minutes or less.
  - .2 Packing group II is assigned to substances that cause full thickness destruction of intact skin tissue within an observation period of up to 14 days starting after an exposure time of more than 3 but not more than 60 minutes.
  - .3 Packing group III is assigned to substances that:
    - .1 cause full thickness destruction of intact skin tissue within an observation period of up to 14 days starting after an exposure time of more than 60 minutes but not more than 4 hours; or
    - .2 are judged not to cause full thickness destruction of intact skin tissue but which exhibit a corrosion rate on either steel or aluminium surfaces exceeding 6.25 mm a year at a test temperature of 55°C when tested on both materials. For the purposes of testing steel, type S235JR+CR (1.0037 resp. St 37-2), S275J2G3+CR (1.0144 resp. St 44-3), ISO 3574:1999, Unified Numbering System (UNS) G10200 or SAE 1020, and for testing aluminium, non-clad, types 7075-T6 or AZ5GU T6 shall be used. An acceptable test is prescribed in the United Nations *Manual of Tests and Criteria*, part III, Section 37.
- Note:** Where an initial test on either steel or aluminium indicates the substance being tested is corrosive, the follow-up test on the other metal is not required.

Table 2.8.2.5 – Table summarizing the criteria in 2.8.2.5

Packing Group	Exposure Time	Observation Period	Effect
I	≤ 3 min	≤ 60 min	Full thickness destruction of intact skin
II	> 3 min ≤ 1 h	≤ 14 d	Full thickness destruction of intact skin
III	> 1 h ≤ 4 h	≤ 14 d	Full thickness destruction of intact skin
III	–	–	Corrosion rate on either steel or aluminium surfaces exceeding 6.25 mm a year at a test temperature of 55 °C when tested on both materials

\* OECD Guideline for the testing of chemicals No. 404 "Acute Dermal Irritation/Corrosion" 2002.

† OECD Guideline for the testing of chemicals No. 435 "In Vitro Membrane Barrier Test Method for Skin Corrosion" 2006.

‡ OECD Guideline for the testing of chemicals No. 430 "In Vitro Skin Corrosion: Transcutaneous Electrical Resistance Test (TER)" 2004.

§ OECD Guideline for the testing of chemicals No. 431 "In Vitro Skin Corrosion: Human Skin Model Test" 2004.

## Chapter 2.9

---

### *Miscellaneous dangerous substances and articles (Class 9) and environmentally hazardous substances*

**Note 1:** For the purposes of this Code, the environmentally hazardous substances (aquatic environment) criteria contained in this chapter apply to the classification of marine pollutants (see 2.10).

**Note 2:** Although the environmentally hazardous substances (aquatic environment) criteria apply to all hazard classes (see 2.10.2.3 and 2.10.2.5), the criteria have been included in this chapter.

#### 2.9.1 Definitions

2.9.1.1 *Class 9 substances and articles (miscellaneous dangerous substances and articles)* are substances and articles which, during transport, present a danger not covered by other classes.

#### 2.9.2 Assignment to class 9

2.9.2.1 Class 9 includes, *inter alia*:

- .1 substances and articles not covered by other classes which experience has shown, or may show, to be of such a dangerous character that the provisions of part A of chapter VII of SOLAS 1974, as amended, shall apply.
- .2 substances not subject to the provisions of part A in chapter VII of the aforementioned Convention, but to which the provisions of Annex III of MARPOL 73/78, as amended, apply.

2.9.2.2 The substances and articles of class 9 are subdivided as follows:

##### **Substances which, on inhalation as fine dust, may endanger health**

- 2212 BLUE ASBESTOS (crocidolite) or
- 2212 BROWN ASBESTOS (amosite, miosorite)
- 2590 WHITE ASBESTOS (chrysotile, actinolite, anthophyllite, tremolite)

##### **Substances evolving flammable vapour**

- 2211 POLYMERIC BEADS, EXPANDABLE, evolving flammable vapour
- 3314 PLASTICS MOULDING COMPOUND in dough, sheet or extruded rope form evolving flammable vapour

##### **Lithium batteries**

- 3090 LITHIUM METAL BATTERIES (including lithium alloy batteries)
- 3091 LITHIUM METAL BATTERIES CONTAINED IN EQUIPMENT (including lithium alloy batteries) or
- 3091 LITHIUM METAL BATTERIES PACKED WITH EQUIPMENT (including lithium alloy batteries)
- 3480 LITHIUM ION BATTERIES (including lithium ion polymer batteries)
- 3481 LITHIUM ION BATTERIES CONTAINED IN EQUIPMENT (including lithium ion polymer batteries) or
- 3481 LITHIUM ION BATTERIES PACKED WITH EQUIPMENT (including lithium ion polymer batteries)

**Note:** See 2.9.4.

## Part 2 – Classification

**Electric double layer capacitors**

3499 CAPACITOR, electric double layer (with an energy storage capacity greater than 0.3 Wh)

**Life-saving appliances**

2990 LIFE-SAVING APPLIANCES, SELF-INFLATING

3072 LIFE-SAVING APPLIANCES NOT SELF-INFLATING containing dangerous goods as equipment

3268 AIR BAG INFLATORS or

3268 AIR BAG MODULES or

3268 SEAT BELT PRETENSIONERS

**Substances and articles which, in the event of fire, may form dioxins**

This group of substances includes:

2315 POLYCHLORINATED BIPHENYLS, LIQUID

3432 POLYCHLORINATED BIPHENYLS, SOLID

3151 POLYHALOGENATED BIPHENYLS, LIQUID or

3151 POLYHALOGENATED TERPHENYLS, LIQUID

3152 POLYHALOGENATED BIPHENYLS, SOLID or

3152 POLYHALOGENATED TERPHENYLS, SOLID

Examples of articles are transformers, condensers and apparatus containing those substances.

**Substances transported or offered for transport at elevated temperatures**

3257 ELEVATED TEMPERATURE LIQUID, N.O.S., at or above 100°C and below its flashpoint (including molten metal, molten salts, etc.)

3258 ELEVATED TEMPERATURE SOLID, N.O.S., at or above 240°C

**Environmentally hazardous substances**

3077 ENVIRONMENTALLY HAZARDOUS SUBSTANCE, SOLID, N.O.S.

3082 ENVIRONMENTALLY HAZARDOUS SUBSTANCE, LIQUID, N.O.S.

These entries are used for substances and mixtures which are dangerous to the aquatic environment that do not meet the classification criteria of any other class or another substance within class 9. These entries may also be used for wastes not otherwise subject to the provisions of this Code but which are covered under the Basel Convention on the Control of Transboundary Movements of Hazardous Wastes and their Disposal and for substances designated to be environmentally hazardous substances by the competent authority of the country of origin, transit or destination which do not meet the criteria for an environmentally hazardous substance according to the provisions of this Code or for any other hazard class. The criteria for substances which are hazardous to the aquatic environment are given in section 2.9.3.

**Genetically modified microorganisms (GMMOs) and genetically modified organisms (GMOs)**

3245 GENETICALLY MODIFIED MICROORGANISMS or

3245 GENETICALLY MODIFIED ORGANISMS

GMMOs and GMOs which do not meet the definition of toxic substances (see 2.6.2) or infectious substances (see 2.6.3) shall be assigned to UN 3245.

GMMOs or GMOs are not subject to the provisions of this Code when authorized for use by the competent authorities of the countries of origin, transit and destination.

Genetically modified live animals shall be transported under terms and conditions of the competent authorities of the countries of origin and destination.

**Other substances or articles presenting a danger during transport, but not meeting the definitions of another class:**

1841 ACETALDEHYDE AMMONIA

1845	CARBON DIOXIDE, SOLID (DRY ICE)
1931	ZINC DITHIONITE (ZINC HYDROSULPHITE)
1941	DIBROMODIFLUOROMETHANE
1990	BENZALDEHYDE
2071	AMMONIUM NITRATE BASED FERTILIZER
2216	FISH MEAL (FISH SCRAP), STABILIZED
2807	MAGNETIZED MATERIAL*
2969	CASTOR BEANS or
2969	CASTOR MEAL or
2969	CASTOR POMACE or
2969	CASTOR FLAKE
3166	ENGINE, INTERNAL COMBUSTION or
3166	VEHICLE, FLAMMABLE GAS POWERED or
3166	VEHICLE, FLAMMABLE LIQUID POWERED or
3166	ENGINE, FUEL CELL, FLAMMABLE GAS POWERED or
3166	ENGINE, FUEL CELL, FLAMMABLE LIQUID POWERED or
3166	VEHICLE, FUEL CELL, FLAMMABLE GAS POWERED or
3166	VEHICLE, FUEL CELL, FLAMMABLE LIQUID POWERED
3171	BATTERY-POWERED VEHICLE or
3171	BATTERY-POWERED EQUIPMENT
3316	CHEMICAL KIT or
3316	FIRST AID KIT
3334	AVIATION REGULATED LIQUID, N.O.S.*
3335	AVIATION REGULATED SOLID, N.O.S.*
3359	FUMIGATED CARGO TRANSPORT UNIT
3363	DANGEROUS GOODS IN MACHINERY or
3363	DANGEROUS GOODS IN APPARATUS
3496	BATTERIES, NICKEL-METAL HYDRIDE

### 2.9.3 Environmentally hazardous substances (aquatic environment)

#### 2.9.3.1 General definitions

2.9.3.1.1 Environmentally hazardous substances include, *inter alia*, liquid or solid substances pollutant to the aquatic environment and solutions and mixtures of such substances (such as preparations and wastes).

For the purposes of this section,

*Substance* means chemical elements and their compounds in the natural state or obtained by any production process, including any additive necessary to preserve the stability of the product and any impurities deriving from the process used, but excluding any solvent which may be separated without affecting the stability of the substance or changing its composition.

\* Not subject to the provisions of this Code but may be subject to provisions governing the transport of dangerous goods by other modes (see also special provision 960).

## Part 2 – Classification

- 2.9.3.1.2 The aquatic environment may be considered in terms of the aquatic organisms that live in the water, and the aquatic ecosystem of which they are part<sup>\*</sup>. The basis, therefore, of the identification of hazard is the aquatic toxicity of the substance or mixture, although this may be modified by further information on the degradation and bioaccumulation behaviour.
- 2.9.3.1.3 While the following classification procedure is intended to apply to all substances and mixtures, it is recognized that in some cases, e.g., metals or poorly soluble inorganic compounds, special guidance will be necessary<sup>†</sup>.
- 2.9.3.1.4 The following definitions apply for acronyms or terms used in this section:
- |   |   |
|---|---|
| BCF   | Bioconcentration Factor;  |
| BOD   | Biochemical Oxygen Demand;  |
| COD   | Chemical Oxygen Demand;   |
| GLP   | Good Laboratory Practices;  |
| EC <sub>x</sub>                             | the concentration associated with x% response;  |
| EC <sub>50</sub>                            | the effective concentration of substance that causes 50% of the maximum response;   |
| ErC <sub>50</sub>                           | EC <sub>50</sub> in terms of reduction of growth;   |
| K <sub>ow</sub>                             | octanol/water partition coefficient;  |
| LC <sub>50</sub> (50% lethal concentration) | the concentration of a substance in water which causes the death of 50% (one half) in a group of test animals;  |
| L(E)C <sub>50</sub>                         | LC <sub>50</sub> or EC <sub>50</sub> ;  |
| NOEC (No Observed Effect Concentration)     | the test concentration immediately below the lowest tested concentration with statistically significant adverse effect. The NOEC has no statistically significant adverse effect compared to the control; |
| OECD Test Guidelines                        | Test guidelines published by the Organization for Economic Co-operation and Development (OECD).   |
- 2.9.3.2 **Definitions and data requirements**
- 2.9.3.2.1 The basic elements for classification of environmentally hazardous substances (aquatic environment) are:
- acute aquatic toxicity;
  - chronic aquatic toxicity
  - potential for or actual bioaccumulation; and
  - degradation (biotic or abiotic) for organic chemicals;
- 2.9.3.2.2 While data from internationally harmonized test methods are preferred, in practice, data from national methods may also be used where they are considered as equivalent. In general, it has been agreed that freshwater and marine species toxicity data can be considered as equivalent data and are preferably to be derived using OECD Test Guidelines or equivalent according to the principles of Good Laboratory Practices (GLP). Where such data are not available, classification shall be based on the best available data.
- 2.9.3.2.3 *Acute aquatic toxicity* means the intrinsic property of a substance to be injurious to an organism in a short-term aquatic exposure to that substance.
- Acute (short-term) hazard*, for classification purposes, means the hazard of a chemical caused by its acute toxicity to an organism during short-term aquatic exposure to that chemical.
- Acute aquatic toxicity shall normally be determined using a fish 96 hour LC<sub>50</sub> (OECD Test Guideline 203 or equivalent), a crustacea species 48 hour EC<sub>50</sub> (OECD Test Guideline 202 or equivalent) and/or an algal species 72 or 96 hour EC<sub>50</sub> (OECD Test Guideline 201 or equivalent). These species are considered as surrogate for all aquatic organisms and data on other species such as Lemna may also be considered if the test methodology is suitable.
- 2.9.3.2.4 Chronic aquatic toxicity means the intrinsic property of a substance to cause adverse effects to aquatic organisms during aquatic exposures which are determined in relation to the life cycle of the organism.

<sup>\*</sup> This does not address aquatic pollutants for which there may be a need to consider effects beyond the aquatic environment such as the impacts on human health, etc.

<sup>†</sup> This can be found in annex 10 of the GHS.



*Long-term hazard*, for classification purposes, means the hazard of a chemical caused by its chronic toxicity following long-term exposure in the aquatic environment.

Chronic toxicity data are less available than acute data and the range of testing procedures less standardized. Data generated according to the OECD Test Guidelines 210 (Fish Early Life Stage) or 211 (Daphnia Reproduction) and 201 (Algal Growth Inhibition) may be accepted. Other validated and internationally accepted tests may also be used. The NOECs or other equivalent  $EC_x$  shall be used.

**2.9.3.2.5** *Bioaccumulation* means net result of uptake, transformation and elimination of a substance in an organism due to all routes of exposure (i.e. air, water, sediment/soil and food).

The potential for bioaccumulation shall normally be determined by using the octanol/water partition coefficient, usually reported as a  $\log K_{ow}$ , determined according to OECD Test Guideline 107 or 117. While this represents a potential to bioaccumulate, an experimentally determined Bioconcentration Factor (BCF) provides a better measure and shall be used in preference when available. A BCF shall be determined according to OECD Test Guideline 305.

**2.9.3.2.6** *Degradation* means the decomposition of organic molecules to smaller molecules and eventually to carbon dioxide, water and salts.

Environmental degradation may be biotic or abiotic (e.g., hydrolysis) and the criteria used reflect this fact. Ready biodegradation is most easily defined using the biodegradability tests (A F) of OECD Test Guideline 301. A pass level in these tests may be considered as indicative of rapid degradation in most environments. These are freshwater tests and thus the use of the results from OECD Test Guideline 306, which is more suitable for marine environments, has also been included. Where such data are not available, a BOD(5 days)/COD ratio  $\geq 0.5$  is considered as indicative of rapid degradation. Abiotic degradation such as hydrolysis, primary degradation, both abiotic and biotic, degradation in non-aquatic media and proven rapid degradation in the environment may all be considered in defining rapid degradability<sup>†</sup>.

Substances are considered rapidly degradable in the environment if the following criteria are met:

- (a) In 28-day ready biodegradation studies, the following levels of degradation are achieved:
  - (i) Tests based on dissolved organic carbon: 70%;
  - (ii) Tests based on oxygen depletion or carbon dioxide generation: 60% of theoretical maxima.

These levels of biodegradation shall be achieved within 10 days of the start of degradation which point is taken as the time when 10% of the substance has been degraded, unless the substance is identified as a complex, multi-component substance with structurally similar constituents. In this case, and where there is sufficient justification, the 10-day window condition may be waived and the pass level applied at 28 days<sup>†</sup>;

- (b) In those cases where only BOD and COD data are available, when the ratio of BOD5/COD is  $\geq 0.5$ ; or
- (c) If other convincing scientific evidence is available to demonstrate that the substance or mixture can be degraded (biotically and/or abiotically) in the aquatic environment to a level above 70% within a 28-day period.

### 2.9.3.3 Substance classification categories and criteria

**2.9.3.3.1** Substances shall be classified as “environmentally hazardous substances (aquatic environment)”, if they satisfy the criteria for Acute 1, Chronic 1 or Chronic 2, according to Table 2.9.1. These criteria describe in detail the classification categories. They are diagrammatically summarized in Table 2.9.2.

Table 2.9.1 – Categories for substances hazardous to the aquatic environment (see Note 1)

#### (a) Acute (short-term) aquatic hazard

Category: Acute 1 (see Note 2)	
96 hr $LC_{50}$ (for fish)	$\leq 1$ mg/ℓ and/or
48 hr $EC_{50}$ (for crustacea)	$\leq 1$ mg/ℓ and/or
72 or 96 hr $ErC_{50}$ (for algae or other aquatic plants)	$\leq 1$ mg/ℓ (see Note 3)

\* Special guidance on data interpretation is provided in chapter 4.1 and annex 9 of the GHS.

† See chapter 4.1 and annex 9, paragraph A9.4.2.2.3 of the GHS.

Part 2 – Classification

(b) Long-term aquatic hazard (see also Figure 2.9.1)

- (i) Non-rapidly degradable substances (see Note 4) for which there are adequate chronic toxicity data available

<b>Category Chronic 1:</b> (see Note 2)	
Chronic NOEC or EC <sub>x</sub> (for fish)	≤ 0.1 mg/ℓ and/or
Chronic NOEC or EC <sub>x</sub> (for crustacea)	≤ 0.1 mg/ℓ and/or
Chronic NOEC or EC <sub>x</sub> (for algae or other aquatic plants)	≤ 0.1 mg/ℓ
<b>Category Chronic 2:</b>	
Chronic NOEC or EC <sub>x</sub> (for fish)	≤ 1 mg/ℓ and/or
Chronic NOEC or EC <sub>x</sub> (for crustacea)	≤ 1 mg/ℓ and/or
Chronic NOEC or EC <sub>x</sub> (for algae or other aquatic plants)	≤ 1 mg/ℓ

- (ii) Rapidly degradable substances for which there are adequate chronic toxicity data available

<b>Category Chronic 1:</b> (see Note 2)	
Chronic NOEC or EC <sub>x</sub> (for fish)	≤ 0.01 mg/ℓ and/or
Chronic NOEC or EC <sub>x</sub> (for crustacea)	≤ 0.01 mg/ℓ and/or
Chronic NOEC or EC <sub>x</sub> (for algae or other aquatic plants)	≤ 0.01 mg/ℓ
<b>Category Chronic 2:</b>	
Chronic NOEC or EC <sub>x</sub> (for fish)	≤ 0.1 mg/ℓ and/or
Chronic NOEC or EC <sub>x</sub> (for crustacea)	≤ 0.1 mg/ℓ and/or
Chronic NOEC or EC <sub>x</sub> (for algae or other aquatic plants)	≤ 0.1 mg/ℓ

- (iii) Substances for which adequate chronic toxicity data are not available

<b>Category Chronic 1:</b> (see Note 2)	
96 hr LC <sub>50</sub> (for fish)	≤ 1 mg/ℓ and/or
48 hr EC <sub>50</sub> (for crustacea)	≤ 1 mg/ℓ and/or
72 or 96 hr ErC <sub>50</sub> (for algae or other aquatic plants)	≤ 1 mg/ℓ (see Note 3)
and the substance is not rapidly degradable and/or the experimentally determined BCF is ≥ 500 (or, if absent the log K <sub>ow</sub> ≥ 4) (see Notes 4 and 5)	
<b>Category Chronic 2:</b>	
96 hr LC <sub>50</sub> (for fish)	> 1 but ≤ 10 mg/ℓ and/or
48 hr EC <sub>50</sub> (for crustacea)	> 1 but ≤ 10 mg/ℓ and/or
72 or 96 hr ErC <sub>50</sub> (for algae or other aquatic plants)	> 1 but ≤ 10 mg/ℓ and/or (see Note 3)
and the substance is not rapidly degradable and/or the experimentally determined BCF is ≥ 500 (or, if absent the log K <sub>ow</sub> ≥ 4) (see Notes 4 and 5)	

**Note 1:** The organisms fish, crustacea and algae are tested as surrogate species covering a range of trophic levels and taxa, and the test methods are highly standardized. Data on other organisms may also be considered, however, provided they represent equivalent species and test endpoints.

**Note 2:** When classifying substances as Acute 1 and/or Chronic 1 it is necessary at the same time to indicate an appropriate M factor (see 2.9.3.4.6.4) to apply the summation method.

**Note 3:** Where the algal toxicity ErC<sub>50</sub> (= EC<sub>50</sub> (growth rate)) falls more than 100 times below the next most sensitive species and results in a classification based solely on this effect, consideration shall be given to whether this toxicity is representative of the toxicity to aquatic plants. Where it can be shown that this is not the case, professional judgment shall be used in deciding if classification shall be applied. Classification shall be based on the ErC<sub>50</sub>. In circumstances where the basis of the EC<sub>50</sub> is not specified and no ErC<sub>50</sub> is recorded, classification shall be based on the lowest EC<sub>50</sub> available.

**Note 4:** Lack of rapid degradability is based on either a lack of ready biodegradability or other evidence of lack of rapid degradation. When no useful data on degradability are available, either experimentally determined or estimated data, the substance shall be regarded as not rapidly degradable.

**Note 5:** Potential to bioaccumulate, based on an experimentally derived BCF ≥ 500 or, if absent, a log K<sub>ow</sub> ≥ 4 provided log K<sub>ow</sub> is an appropriate descriptor for the bioaccumulation potential of the substance. Measured log K<sub>ow</sub> values take precedence over estimated values and measured BCF values take precedence over log K<sub>ow</sub> values.

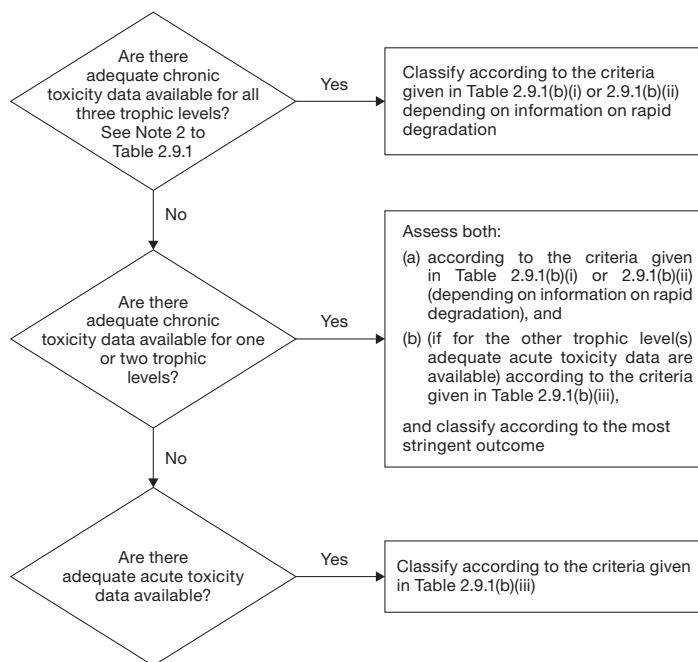

Figure 2.9.1 – Categories for substances long-term hazardous to the aquatic environment

2.9.3.3.2 The classification scheme in Table 2.9.2 below summarizes the classification criteria for substances.

Table 2.9.2 – Classification scheme for substances hazardous to the aquatic environment

Classification categories			
Acute hazard (see Note 1)	Long-term hazard (see Note 2)		
	Adequate chronic toxicity data available		Adequate chronic toxicity data not available (see Note 1)
	Non-rapidly degradable substances (see Note 3)	Rapidly degradable substances (see Note 3)	
<b>Category: Acute 1</b>	<b>Category: Chronic 1</b>	<b>Category: Chronic 1</b>	<b>Category: Chronic 1</b>
$L(E)C_{50} \leq 1.00$	NOEC or $EC_x \leq 0.1$	NOEC or $EC_x \leq 0.01$	$L(E)C_{50} \leq 1.00$ and lack of rapid degradability and/or $BCF \geq 500$ or, if absent $\log K_{ow} \geq 4$
	<b>Category: Chronic 2</b>	<b>Category: Chronic 2</b>	<b>Category: Chronic 2</b>
	$0.1 < NOEC \text{ or } EC_x \leq 1$	$0.01 < NOEC \text{ or } EC_x \leq 0.1$	$1.00 < L(E)C_{50} \leq 10.0$ and lack of rapid degradability and/or $BCF \geq 500$ or, if absent $\log K_{ow} \geq 4$

**Note 1:** Acute toxicity band based on  $L(E)C_{50}$  values in  $mg/\ell$  for fish, crustacea and/or algae or other aquatic plants (or Quantitative Structure Activity Relationships (QSAR) estimation if no experimental data<sup>\*</sup>).

**Note 2:** Substances are classified in the various chronic categories unless there are adequate chronic toxicity data available for all three trophic levels above the water solubility or above  $1 \text{ mg}/\ell$ . (“Adequate” means that the data sufficiently cover the endpoint of concern. Generally this would mean measured test data, but in order to avoid unnecessary testing it can on a case by case basis also be estimated data, e.g., (Q)SAR, or for obvious cases expert judgment).

\* Special guidance is provided in chapter 4.1, paragraph 4.1.2.13 and annex 9, section A9.6 of the GHS.

Part 2 – Classification

**Note 3:** Chronic toxicity band based on NOEC or equivalent EC<sub>x</sub> values in mg/ℓ for fish or crustacea or other recognized measures for chronic toxicity.

2.9.3.4 Mixtures classification categories and criteria

2.9.3.4.1 The classification system for mixtures covers the classification categories which are used for substances, meaning categories Acute 1 and Chronic 1 and 2. In order to make use of all available data for purposes of classifying the aquatic environmental hazards of the mixture, the following assumption is made and is applied where appropriate:

The “relevant ingredients” of a mixture are those which are present in a concentration equal to or greater than 0.1% (by mass) for ingredients classified as Acute and/or Chronic 1 and equal to or greater than 1% for other ingredients, unless there is a presumption (e.g., in the case of highly toxic ingredients) that an ingredient present at less than 0.1% can still be relevant for classifying the mixture for aquatic environmental hazards.

2.9.3.4.2 The approach for classification of aquatic environmental hazards is tiered, and is dependent upon the type of information available for the mixture itself and for its ingredients. Elements of the tiered approach include:

- (a) classification based on tested mixtures;
- (b) classification based on bridging principles;
- (c) the use of “summation of classified ingredients” and/or an “additivity formula”.

Figure 2.9.2 below outlines the process to be followed.

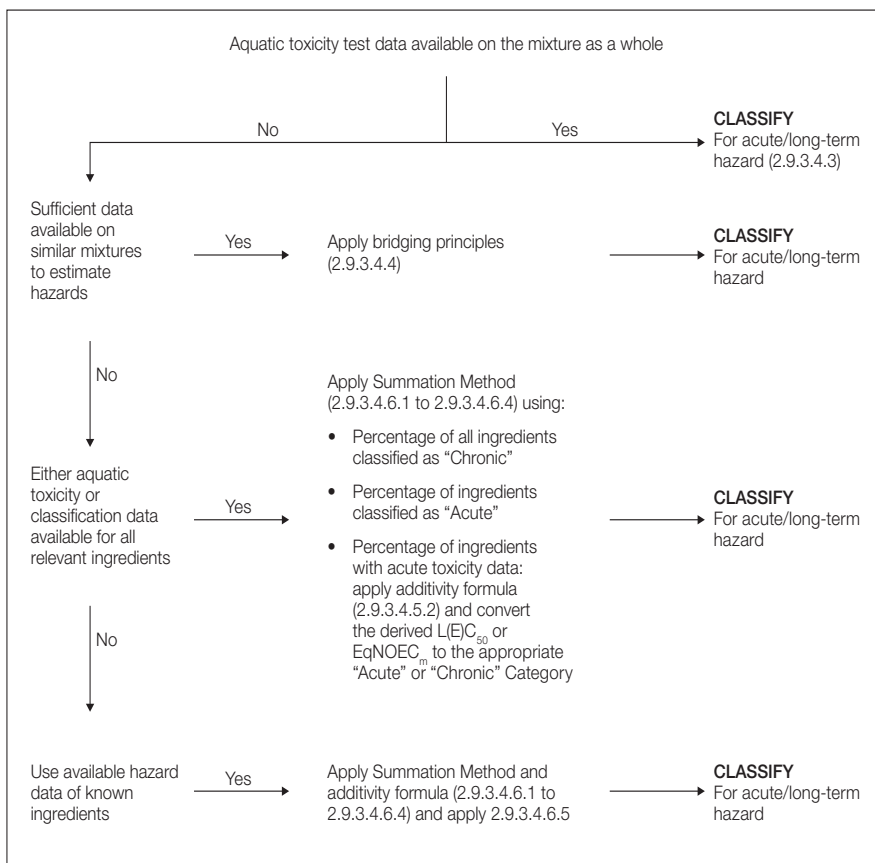

Figure 2.9.2 – Tiered approach to classification of mixtures for acute and long-term aquatic environmental hazards

- 2.9.3.4.3 Classification of mixtures when toxicity data are available for the complete mixture**
- 2.9.3.4.3.1** When the mixture as a whole has been tested to determine its aquatic toxicity, this information shall be used for classifying the mixture according to the criteria that have been agreed for substances. The classification is normally based on the data for fish, crustacea and algae/plants (see 2.9.3.2.3 and 2.9.3.2.4). When adequate acute or chronic data for the mixture as a whole are lacking, “bridging principles” or “summation method” shall be applied (see 2.9.3.4.4 to 2.9.3.4.6).
- 2.9.3.4.3.2** The long-term hazard classification of mixtures requires additional information on degradability and in certain cases bioaccumulation. There are no degradability and bioaccumulation data for mixtures as a whole. Degradability and bioaccumulation tests for mixtures are not used as they are usually difficult to interpret, and such tests may be meaningful only for single substances.
- 2.9.3.4.3.3 Classification for category Acute 1**
- (a) When there are adequate acute toxicity test data ( $LC_{50}$  or  $EC_{50}$ ) available for the mixture as a whole showing  $L(E)C_{50} \leq 1 \text{ mg/l}$ :  
Classify the mixture as Acute 1 in accordance with Table 2.9.1 (a);
- (b) When there are acute toxicity test data ( $LC_{50}(s)$  or  $EC_{50}(s)$ ) available for the mixture as a whole showing  $L(E)C_{50}(s) > 1 \text{ mg/l}$ , or above the water solubility:  
No need to classify for acute hazard under these Regulations.
- 2.9.3.4.3.4 Classification for categories Chronic 1 and 2**
- (a) When there are adequate chronic toxicity data ( $EC_x$  or NOEC) available for the mixture as a whole showing  $EC_x$  or NOEC of the tested mixture  $\leq 1 \text{ mg/l}$ :  
(i) classify the mixture as Chronic 1 or 2 in accordance with Table 2.9.1 (b)(ii) (rapidly degradable) if the available information allows the conclusion that all relevant ingredients of the mixture are rapidly degradable;  
(ii) classify the mixture as Chronic 1 or 2 in all other cases in accordance with Table 2.9.1 (b)(i) (non-rapidly degradable);
- (b) When there are adequate chronic toxicity data ( $EC_x$  or NOEC) available for the mixture as a whole showing  $EC_x(s)$  or NOEC(s) of the tested mixture  $> 1 \text{ mg/l}$  or above the water solubility:  
No need to classify for long-term hazard under these Regulations.
- 2.9.3.4.4 Classification of mixtures when toxicity data are not available for the complete mixture: bridging principles**
- 2.9.3.4.4.1** Where the mixture itself has not been tested to determine its aquatic environmental hazard, but there are sufficient data on the individual ingredients and similar tested mixtures to adequately characterize the hazards of the mixture, these data shall be used in accordance with the following agreed bridging rules. This ensures that the classification process uses the available data to the greatest extent possible in characterizing the hazards of the mixture without the necessity for additional testing in animals.
- 2.9.3.4.4.2 Dilution**
- 2.9.3.4.4.2.1** Where a new mixture is formed by diluting a tested mixture or a substance with a diluent which has an equivalent or lower aquatic hazard classification than the least toxic original ingredient and which is not expected to affect the aquatic hazards of other ingredients, then the resulting mixture shall be classified as equivalent to the original tested mixture or substance. Alternatively, the method explained in 2.9.3.4.5 may be applied.
- 2.9.3.4.4.2.2** If a mixture is formed by diluting another classified mixture or a substance with water or other totally non-toxic material, the toxicity of the mixture shall be calculated from the original mixture or substance.
- 2.9.3.4.4.3 Batching**
- 2.9.3.4.4.3.1** The aquatic hazard classification of a tested production batch of a mixture shall be assumed to be substantially equivalent to that of another untested production batch of the same commercial product when produced by or under the control of the same manufacturer, unless there is reason to believe there is significant variation such that the aquatic hazard classification of the untested batch has changed. If the latter occurs, new classification is necessary.
- 2.9.3.4.4.4 Concentration of mixtures which are classified with the most severe classification categories (Chronic 1 and Acute 1)**
- 2.9.3.4.4.4.1** If a tested mixture is classified as Chronic 1 and/or Acute 1, and the ingredients of the mixture which are classified as Chronic 1 and/or Acute 1 are further concentrated, the more concentrated untested mixture shall be classified with the same classification category as the original tested mixture without additional testing.

Part 2 – Classification

2.9.3.4.4.5 *Interpolation within one toxicity category*

2.9.3.4.4.5.1 For three mixtures (A, B and C) with identical ingredients, where mixtures A and B have been tested and are in the same toxicity category, and where untested mixture C has the same toxicologically active ingredients as mixtures A and B but has concentrations of toxicologically active ingredients intermediate to the concentrations in mixtures A and B, then mixture C is assumed to be in the same category as A and B.

2.9.3.4.4.6 *Substantially similar mixtures*

2.9.3.4.4.6.1 Given the following:

- (a) Two mixtures:
  - (i) A + B
  - (ii) C + B
- (b) The concentration of ingredient B is essentially the same in both mixtures;
- (c) The concentration of ingredient A in mixture (i) equals that of ingredient C in mixture (ii);
- (d) Data on aquatic hazards for A and C are available and are substantially equivalent, i.e. they are in the same hazard category and are not expected to affect the aquatic toxicity of B.

If mixture (i) or (ii) is already classified based on test data, then the other mixture can be assigned the same hazard category.

2.9.3.4.5 *Classification of mixtures when toxicity data are available for all ingredients or only for some ingredients of the mixture*

2.9.3.4.5.1 The classification of a mixture shall be based on summation of the concentrations of its classified ingredients. The percentage of ingredients classified as “Acute” or “Chronic” will feed straight into the summation method. Details of the summation method are described in 2.9.3.4.6.1 to 2.9.3.4.6.4.1.

2.9.3.4.5.2 Mixtures may be made of a combination of both ingredients that are classified (as Acute 1 and/or Chronic 1, 2) and those for which adequate toxicity test data are available. When adequate toxicity data are available for more than one ingredient in the mixture, the combined toxicity of those ingredients shall be calculated using the following additivity formulas (a) or (b), depending on the nature of the toxicity data:

(a) Based on acute aquatic toxicity:

$$\frac{\sum C_i}{L(E)C_{50m}} = \sum_n \frac{C_i}{L(E)C_{50i}}$$

where:  $C_i$  = concentration of ingredient  $i$  (mass percentage);

$L(E)C_{50i}$  =  $LC_{50}$  or  $EC_{50}$  for ingredient  $i$  (mg/l);

$n$  = number of ingredients, and  $i$  is running from 1 to  $n$ ; and

$L(E)C_{50m}$  =  $L(E)C_{50}$  of the part of the mixture with test data

The calculated toxicity shall be used to assign that portion of the mixture an acute hazard category which is then subsequently used in applying the summation method;

(b) Based on chronic aquatic toxicity:

$$\frac{\sum C_i + \sum C_j}{EqNOEC_m} = \sum_n \frac{C_i}{NOEC_i} + \sum_n \frac{C_j}{0.1 \times NOEC_j}$$

where:  $C_i$  = concentration of ingredient  $i$  (mass percentage) covering the rapidly degradable ingredients;

$C_j$  = concentration of ingredient  $j$  (mass percentage) covering the non-rapidly degradable ingredients;

$NOEC_i$  = NOEC (or other recognized measures for chronic toxicity) for ingredient  $i$  covering the rapidly degradable ingredients, in mg/l;

$NOEC_j$  = NOEC (or other recognized measures for chronic toxicity) for ingredient  $j$  covering the non-rapidly degradable ingredients, in mg/l;

$n$  = number of ingredients, and  $i$  and  $j$  are running from 1 to  $n$ ;

$EqNOEC_m$  = equivalent NOEC of the part of the mixture with test data;

The equivalent toxicity thus reflects the fact that non-rapidly degrading substances are classified one hazard category level more “severe” than rapidly degrading substances.

The calculated equivalent toxicity shall be used to assign that portion of the mixture a long-term hazard category, in accordance with the criteria for rapidly degradable substances (Table 2.9.1 (b)(ii)), which is then subsequently used in applying the summation method.

- 2.9.3.4.5.3** When applying the additivity formula for part of the mixture, it is preferable to calculate the toxicity of this part of the mixture using for each ingredient toxicity values that relate to the same taxonomic group (i.e. fish, crustacea or algae) and then to use the highest toxicity (lowest value) obtained (i.e. use the most sensitive of the three groups). However, when toxicity data for each ingredient are not available in the same taxonomic group, the toxicity value of each ingredient shall be selected in the same manner that toxicity values are selected for the classification of substances, i.e. the higher toxicity (from the most sensitive test organism) is used. The calculated acute and chronic toxicity shall then be used to classify this part of the mixture as Acute 1 and/or Chronic 1 or 2 using the same criteria described for substances.
- 2.9.3.4.5.4** If a mixture is classified in more than one way, the method yielding the more conservative result shall be used.
- 2.9.3.4.6** *Summation method*
- 2.9.3.4.6.1** *Classification procedure*
- 2.9.3.4.6.1.1** In general a more severe classification for mixtures overrides a less severe classification, e.g., a classification with Chronic 1 overrides a classification with Chronic 2. As a consequence the classification procedure is already completed if the results of the classification is Chronic 1. A more severe classification than Chronic 1 is not possible; therefore, it is not necessary to pursue the classification procedure further.
- 2.9.3.4.6.2** *Classification for the category Acute 1*
- 2.9.3.4.6.2.1** First, all ingredients classified as Acute 1 are considered. If the sum of the concentrations (in %) of these ingredients is greater than or equal to 25% the whole mixture shall be classified as Acute 1. If the result of the calculation is a classification of the mixture as Acute 1, the classification process is completed.
- 2.9.3.4.6.2.2** The classification of mixtures for acute hazards based on this summation of the concentrations of classified ingredients is summarized in Table 2.9.3 below.

**Table 2.9.3 – Classification of a mixture for acute hazards based on summation of the concentrations of classified ingredients**

Sum of the concentrations (in %) of ingredients classified as:	Mixture is classified as:
Acute 1 × M <sup>a</sup> ≥ 25%	Acute 1

<sup>a</sup>For explanation of the M factor, see 2.9.3.4.6.4.

- 2.9.3.4.6.3** *Classification for categories Chronic 1 and 2*
- 2.9.3.4.6.3.1** First, all ingredients classified as Chronic 1 are considered. If the sum of the concentrations (in %) of these ingredients is greater than or equal to 25% the mixture shall be classified as Chronic 1. If the result of the calculation is a classification of the mixture as Chronic 1 the classification procedure is completed
- 2.9.3.4.6.3.2** In cases where the mixture is not classified as Chronic 1, classification of the mixture as Chronic 2 is considered. A mixture shall be classified as Chronic 2 if 10 times the sum of the concentrations (in %) of all ingredients classified as Chronic 1 plus the sum of the concentrations (in %) of all ingredients classified as Chronic 2 is greater than or equal to 25%. If the result of the calculation is classification of the mixture as Chronic 2, the classification process is completed.
- 2.9.3.4.6.3.3** The classification of mixtures for long-term hazards based on this summation of the concentrations of classified ingredients is summarized in Table 2.9.4 below.

**Table 2.9.4 – Classification of a mixture for long-term hazards based on summation of the concentrations of classified ingredients**

Sum of the concentrations (in %) of ingredients classified as:	Mixture classified as:
Chronic 1 × M <sup>a</sup> ≥ 25%	Chronic 1
(M × 10 × Chronic 1) + Chronic 2 ≥ 25%	Chronic 2

<sup>a</sup>For explanation of the M factor, see 2.9.3.4.6.4.

Part 2 – Classification

2.9.3.4.6.4 Mixtures with highly toxic ingredients

2.9.3.4.6.4.1 Acute 1 or Chronic 1 ingredients with acute toxicities well below 1 mg/l and/or chronic toxicities well below 0.1 mg/l (if non-rapidly degradable) and 0.01 mg/l (if rapidly degradable) may influence the toxicity of the mixture and are given increased weight in applying the summation method. When a mixture contains ingredients classified as Acute 1 or Chronic 1, the tiered approach described in 2.9.3.4.6.2 and 2.9.3.4.6.3 shall be applied using a weighted sum by multiplying the concentrations of Acute 1 and Chronic 1 ingredients by a factor, instead of merely adding up the percentages. This means that the concentration of “Acute 1” in the left column of Table 2.9.3 and the concentration of “Chronic 1” in the left column of Table 2.9.4 are multiplied by the appropriate multiplying factor. The multiplying factors to be applied to these ingredients are defined using the toxicity value, as summarized in Table 2.9.5 below. Therefore, in order to classify a mixture containing Acute 1 and/or Chronic 1 ingredients, the classifier needs to be informed of the value of the M factor in order to apply the summation method. Alternatively, the additivity formula (2.9.3.4.5.2) may be used when toxicity data are available for all highly toxic ingredients in the mixture and there is convincing evidence that all other ingredients, including those for which specific acute and/or chronic toxicity data are not available, are of low or no toxicity and do not significantly contribute to the environmental hazard of the mixture.

Table 2.9.5 – Multiplying factors for highly toxic ingredients of mixtures

Acute toxicity L(E)C <sub>50</sub> value	M factor	Chronic toxicity NOEC value	M factor	
			NRD <sup>a</sup> ingredients	RD <sup>b</sup> ingredients
0.1 < L(E)C <sub>50</sub> ≤ 1	1	0.01 < NOEC ≤ 0.1	1	-
0.01 < L(E)C <sub>50</sub> ≤ 0.1	10	0.001 < NOEC ≤ 0.01	10	1
0.001 < L(E)C <sub>50</sub> ≤ 0.01	100	0.0001 < NOEC ≤ 0.001	100	10
0.0001 < L(E)C <sub>50</sub> ≤ 0.001	1 000	0.00001 < NOEC ≤ 0.0001	1 000	100
0.00001 < L(E)C <sub>50</sub> ≤ 0.0001	10 000	0.000001 < NOEC ≤ 0.00001	10 000	1 000
(continue in factor 10 intervals)		(continue in factor 10 intervals)		

<sup>a</sup> Non-rapidly degradable.

<sup>b</sup> Rapidly degradable.

2.9.3.4.6.5 Classification of mixtures with ingredients without any useable information

2.9.3.4.6.5.1 In the event that no useable information on acute and/or chronic aquatic toxicity is available for one or more relevant ingredients, it is concluded that the mixture cannot be attributed (a) definitive hazard category(ies). In this situation the mixture shall be classified based on the known ingredients only with the additional statement that: “x percent of the mixture consists of ingredient(s) of unknown hazards to the aquatic environment.”

2.9.4 Lithium batteries

Cells and batteries, cells and batteries contained in equipment, or cells and batteries packed with equipment, containing lithium in any form shall be assigned to UN Nos. 3090, 3091, 3480 or 3481 as appropriate. They may be transported under these entries if they meet the following provisions:

.1 Each cell or battery is of the type proved to meet the requirements of each test of the *Manual of Tests and Criteria*, Part III, sub section 38.3. However batteries and cells manufactured before 1 January 2014 and conforming to a design type tested according to requirements of the 5th revised edition of the *Manual of test and criteria*, part III, sub section 38.3 may continue to be transported;

**Note:** Batteries shall be of a design type proved to meet the testing requirements of the *Manual of Tests and Criteria*, Part III, sub section 38.3, irrespective of whether the cells of which they are composed are of a tested design type.

- .2 Each cell and battery incorporates a safety venting device or is designed to preclude a violent rupture under conditions normally incident to transport;
- .3 Each cell and battery is equipped with an effective means of preventing external short circuits;
- .4 Each battery containing cells or series of cells connected in parallel is equipped with effective means as necessary to prevent dangerous reverse current flow (e.g., diodes, fuses, etc.);
- .5 Cells and batteries shall be manufactured under a quality management programme that includes:



Chapter 2.9 – *Miscellaneous dangerous substances and articles (Class 9)*

---

- (i) A description of the organizational structure and responsibilities of personnel with regard to design and product quality;
- (ii) The relevant inspection and test, quality control, quality assurance, and process operation instructions that will be used;
- (iii) Process controls that should include relevant activities to prevent and detect internal short circuit failure during manufacture of cells;
- (iv) Quality records, such as inspection reports, test data, calibration data and certificates. Test data shall be kept and made available to the competent authority upon request;
- (v) Management reviews to ensure the effective operation of the quality management programme;
- (vi) A process for control of documents and their revision;
- (vii) A means for control of cells or batteries that are not conforming to the type tested as mentioned in (.1) above;
- (viii) Training programmes and qualification procedures for relevant personnel; and
- (ix) Procedures to ensure that there is no damage to the final product.

**Note:** In house quality management programmes may be accepted. Third party certification is not required, but the procedures listed in (i) to (ix) above shall be properly recorded and traceable. A copy of the quality management programme shall be made available to the competent authority upon request.

## Chapter 2.10

---

### *Marine pollutants*

#### 2.10.1 Definition

*Marine pollutants* means substances which are subject to the provisions of Annex III of MARPOL 73/78, as amended.

#### 2.10.2 General provisions

2.10.2.1 Marine pollutants shall be transported under the provisions of Annex III of MARPOL 73/78, as amended.

2.10.2.2 The Index indicates by the symbol **p** in the column headed **MP** those substances, materials and articles that are identified as marine pollutants.

2.10.2.3 Marine pollutants shall be transported under the appropriate entry according to their properties if they fall within the criteria of any of the classes 1 to 8. If they do not fall within the criteria of any of these classes, they shall be transported under the entry: ENVIRONMENTALLY HAZARDOUS SUBSTANCE, SOLID, N.O.S., UN 3077 or ENVIRONMENTALLY HAZARDOUS SUBSTANCE, LIQUID, N.O.S., UN 3082, as appropriate, unless there is a specific entry in class 9.

2.10.2.4 Column 4 of the Dangerous Goods List also provides information on marine pollutants using the symbol **p**.

2.10.2.5 When a substance, material or article possesses properties that meet the criteria of a marine pollutant but is not identified in this Code, such substance, material or article shall be transported as a marine pollutant in accordance with the Code.

2.10.2.6 With the approval of the competent authority (see 7.9.2), substances, materials or articles that are identified as marine pollutants in this Code but which no longer meet the criteria as a marine pollutant need not be transported in accordance with the provisions of this Code applicable to marine pollutants.

#### 2.10.3 Classification

2.10.3.1 Marine pollutants shall be classified in accordance with chapter 2.9.3.

# **PART 3**

DANGEROUS GOODS LIST,  
SPECIAL PROVISIONS AND EXCEPTIONS



## Chapter 3.1

---

### General

#### 3.1.1 Scope and general provisions

- 3.1.1.1 The Dangerous Goods List in chapter 3.2 lists many of the dangerous goods most commonly transported. The list includes entries for specific chemical substances and articles and generic or "not otherwise specified" entries. Since it is not practical to include a separate entry for every chemical substance or article of commercial importance specifically by name, especially names for mixtures and solutions of various chemical constituents and concentrations, the Dangerous Goods List also includes generic or "not otherwise specified" names (e.g., EXTRACTS, FLAVOURING, LIQUID, UN 1197 or FLAMMABLE LIQUID, N.O.S., UN 1993). On this basis, the Dangerous Goods List is intended to include an appropriate name or entry for any dangerous good which may be transported.
- 3.1.1.2 Where a dangerous good is specifically listed by name in the Dangerous Goods List, it shall be transported in accordance with the provisions in the List which are appropriate for that dangerous good. A generic or "not otherwise specified" entry may be used to permit the transport of substances, materials or articles which do not appear specifically by name in the Dangerous Goods List. Such a dangerous good may be transported only after its dangerous properties have been determined. Dangerous goods shall be classified according to the class definitions, tests and criteria. The name which most appropriately describes the dangerous goods shall be used. Only when the specific name of the dangerous goods does not appear in the Dangerous Goods List or the associated primary or subsidiary hazards assigned to it are not appropriate may a generic or "not otherwise specified" name be used. The classification shall be made by the shipper/consignor or by the appropriate competent authority where so specified in the Code. Once the class of the dangerous good has been so established, all conditions for transport, as provided in this Code, shall be met. Any dangerous good having or suspected of having explosive characteristics shall first be considered for inclusion in class 1. Some collective entries may be of the generic or "not otherwise specified" type provided that the Code contains provisions ensuring safety, both by excluding extremely dangerous goods from normal transport and by covering all subsidiary risks inherent in some goods.
- 3.1.1.3 Inherent instability in goods may take different dangerous forms, for example explosion, polymerization with intense evolution of heat or emission of flammable, toxic, corrosive or asphyxiant gases. The Dangerous Goods List indicates that certain dangerous goods, or dangerous goods in a specific form, concentration or state, are prohibited for transport by sea. This means that the goods specified are not suitable for transport by sea under normal conditions of transport. This does not mean that such goods may not be transported under any circumstances. For most goods, such inherent instability can be controlled by suitable packaging, dilution, stabilization, addition of an inhibitor, temperature control or other measures.
- 3.1.1.4 Where precautionary measures are laid down in the Dangerous Goods List in respect of a given dangerous good (such as that it shall be "stabilized" or "with x% water or phlegmatizer"), such dangerous good may not normally be transported when these measures have not been taken, unless the item in question is listed elsewhere (such as class 1) without any indication of, or with different, precautionary measures.
- 3.1.1.5 Certain substances, by the nature of their chemical composition, tend to polymerize or otherwise react in a dangerous manner under certain conditions of temperature or in contact with a catalyst. Mitigation of this tendency can be carried out either by requiring special transport conditions or by adding adequate amounts of chemical inhibitors or stabilizers to the product. These products shall be sufficiently stabilized to prevent any dangerous reaction during the intended voyage. If this cannot be ensured, the transport of such products is prohibited.
- 3.1.1.6 Where the contents of a portable tank is to be transported heated, the transport temperature is to be maintained during the intended voyage unless it is established that crystallization or solidification on cooling would not result in instability, which can occur with some stabilized or inhibited products.

### 3.1.2 Proper Shipping Names

**Note 1:** The Proper Shipping Names of the dangerous goods are those listed in chapter 3.2, Dangerous Goods List. Synonyms, secondary names, initials, abbreviations of names, etc. have been included in the Index to facilitate the search for the Proper Shipping Name (see part 5, Consignment Procedures).

**Note 2:** For Proper Shipping Names to be used for transport of samples, see 2.0.4. For Proper Shipping Names to be used for transport of wastes, see 5.4.1.4.3.3.

3.1.2.1 The Proper Shipping Name is that portion of the entry most accurately describing the goods in the Dangerous Goods List, which is shown in upper-case characters (plus any numbers, Greek letters, 'sec', 'tert', and the letters *m*, *n*, *o*, *p*, which form an integral part of the name). An alternative Proper Shipping Name may be shown in brackets following the main Proper Shipping Name (such as ETHANOL (ETHYL ALCOHOL)). Portions of an entry appearing in lower case need not be considered as part of the Proper Shipping Name but may be used.

3.1.2.2 When conjunctions such as "and" or "or" are in lower case or when segments of the name are punctuated by commas, the entire name of the entry need not necessarily be shown in the transport document or package markings. This is the case particularly when a combination of several distinct entries are listed under a single UN Number. Examples illustrating the selection of the Proper Shipping Name for such entries are:

.1 UN 1057 LIGHTERS or LIGHTER REFILLS – The Proper Shipping Name is the most appropriate of the following possible combinations:

LIGHTERS  
LIGHTER REFILLS;

.2 UN 2583 ALKYL SULPHONIC ACIDS, SOLID or ARYL SULPHONIC ACIDS, SOLID with more than 5% free sulphuric acid – The Proper Shipping Name is the most appropriate of the following:

ALKYL SULPHONIC ACIDS, SOLID  
ARYL SULPHONIC ACIDS, SOLID;

.3 UN 2793 FERROUS METAL BORINGS, SHAVINGS, TURNINGS or CUTTINGS in a form liable to self-heating. The Proper Shipping Name is the most appropriate of the following combinations:

FERROUS METAL BORINGS  
FERROUS METAL SHAVINGS  
FERROUS METAL TURNINGS  
FERROUS METAL CUTTINGS.

3.1.2.3 Proper Shipping Names may be used in the singular or plural as appropriate. In addition, when qualifying words are used as part of the Proper Shipping Name, their sequence on documentation or packages is optional. Commercial or military names for goods of class 1, which contain the Proper Shipping Name supplemented by additional text, may be used.

3.1.2.4 Many substances have an entry for both the liquid and solid state (see definitions for *liquids* and *solids* in 1.2.1), or for the solid and solution. These are allocated separate UN Numbers which are not necessarily adjacent to each other. Details are provided in the alphabetical index, e.g.:

NITROXYLENES, LIQUID – 6.1 1665  
NITROXYLENES, SOLID – 6.1 3447.

3.1.2.5 Where it is not already included, the qualifying word "MOLTEN" shall be added to the Proper Shipping Name when a substance which is solid in accordance with the definition in 1.2.1 is offered for transport in the molten state (such as ALKYLPHENOL, SOLID, N.O.S., MOLTEN). For elevated temperature substances, see 5.4.1.4.3.4.

3.1.2.6 Except for self-reactive substances and organic peroxides and unless it is already included in capital letters in the name indicated in the Dangerous Goods List, the word STABILIZED shall be added as part of the Proper Shipping Name of the substance which without stabilization would be forbidden from transport in accordance with 1.1.3 due to it being liable to dangerously react under conditions normally encountered in transport (such as TOXIC LIQUID, ORGANIC, N.O.S., STABILIZED). When temperature control is used to stabilize such substances to prevent the development of any dangerous excess pressure, then:

- .1 For liquids: where the SADT is less than or equal to 50°C, the provisions of 7.3.7.5 shall apply;
- .2 For gases: the conditions of transport shall be approved by the competent authority.

3.1.2.7 Hydrates may be transported under the Proper Shipping Name for the anhydrous substance.

**3.1.2.8 Generic or “not otherwise specified” (N.O.S.) entries**

**3.1.2.8.1** Generic and “not otherwise specified” Proper Shipping Names that are assigned to special provision 274 or 318 in column 6 of the Dangerous Goods List shall be supplemented with the technical or chemical group names unless a national law or international convention prohibits its disclosure if it is a controlled substance. For explosives of class 1, the dangerous goods description may be supplemented by additional descriptive text to indicate commercial or military names. Technical and chemical group names shall be entered in brackets immediately following the Proper Shipping Name. An appropriate modifier, such as “contains” or “containing” or other qualifying words such as “mixture”, “solution”, etc., and the percentage of the technical constituent may also be used. For example: “UN 1993 Flammable liquid, n.o.s. (contains xylene and benzene), 3, PG II”.

**3.1.2.8.1.1** The technical name shall be a recognized chemical or biological name or other name currently used in scientific and technical handbooks, journals and texts. Trade names shall not be used for this purpose. In the case of pesticides, only ISO common name(s), other name(s) in the WHO Recommended Classification of Pesticides by Hazard and Guidelines to Classification, or the name(s) of the active substance(s) may be used.

**3.1.2.8.1.2** When a mixture of dangerous goods is described by one of the “N.O.S” or “generic” entries to which special provision 274 has been allocated in the Dangerous Goods List, not more than the two constituents which most predominantly contribute to the hazard or hazards of a mixture need to be shown, excluding controlled substances when their disclosure is prohibited by national law or international convention. If a package containing a mixture is labelled with any subsidiary risk label, one of the two technical names shown in brackets shall be the name of the constituent which compels the use of the subsidiary risk label.

**3.1.2.8.1.3** Examples illustrating the selection of the Proper Shipping Name supplemented with the technical name of goods for such N.O.S. entries are:

UN 2902 PESTICIDE, LIQUID, TOXIC, N.O.S. (drazoxolon)

UN 3394 ORGANOMETALLIC SUBSTANCE, LIQUID, PYROPHORIC, WATER-REACTIVE (trimethylgallium).

**3.1.2.9 Marine pollutants**

**3.1.2.9.1** For generic or “not otherwise specified” (N.O.S.) entries, the Proper Shipping Name shall be supplemented with the recognized chemical name of the marine pollutant.

**3.1.2.9.2** Examples illustrating the selection of the Proper Shipping Name supplemented with the recognized technical name of goods for such entries are indicated below:

UN 1993 FLAMMABLE LIQUID, N.O.S. (propyl acetate, di-n-butyltin di-2-ethylhexanoate) class 3 PG III (50°C c.c.) MARINE POLLUTANT

UN 1263 PAINT (triethylbenzene) class 3 PG III (27°C c.c.) MARINE POLLUTANT

**3.1.3 Mixtures or solutions**

**Note:** Where a substance is specifically listed by name in the Dangerous Goods List, it shall be identified in transport by the Proper Shipping Name in the Dangerous Goods List. Such substances may contain technical impurities (for example those deriving from the production process) or additives for stability or other purposes that do not affect their classification. However, a substance listed by name containing technical impurities or additives for stability or other purposes affecting its classification shall be considered a mixture or solution (see 2.0.2.2 and 2.0.2.5).

**3.1.3.1** A mixture or solution is not subject to the provisions of this Code if the characteristics, properties, form or physical state of the mixture or solution are such that it does not meet the criteria, including human experience criteria, for inclusion in any class.

**3.1.3.2** A mixture or solution meeting the classification criteria of this Code composed of a single predominant substance identified by name in the Dangerous Goods List and one or more substances not subject to the provisions of this Code and/or traces of one or more substances identified by name in the Dangerous Goods List, shall be assigned the UN Number and Proper Shipping Name of the predominant substance named in the Dangerous Goods List unless:

- .1 the mixture or solution is identified by name in the Dangerous Goods List;
- .2 the name and description of the substance named in the Dangerous Goods List specifically indicate that they apply only to the pure substance;
- .3 the hazard class or division, subsidiary risk(s), packing group, or physical state of the mixture or solution is different from that of the substance named in the Dangerous Goods List; or
- .4 the hazard characteristics and properties of the mixture or solution necessitate emergency response measures that are different from those required for the substance identified by name in the Dangerous Goods List.

---

 Dangerous Goods List, special provisions and exceptions –
 

---

3.1.3.3 Qualifying words such as "MIXTURE" or "SOLUTION", as appropriate, shall be added as part of the Proper Shipping Name, for example, "ACETONE SOLUTION". In addition, the concentration of the mixture or solution may also be indicated after the basic description of the mixture or solution, for example, "ACETONE 75% SOLUTION".

3.1.3.4 A mixture or solution meeting the classification criteria of this Code that is not identified by name in the Dangerous Goods List and that is composed of two or more dangerous goods shall be assigned to an entry that has the Proper Shipping Name, description, hazard class or division, subsidiary risk(s) and packing group that most precisely describe the mixture or solution.

### 3.1.4 Segregation groups

3.1.4.1 For the purpose of segregation, dangerous goods having certain similar chemical properties have been grouped together in segregation groups, see 7.2.5. Where, in the Dangerous Goods List entry in column 16 (stowage and segregation), a particular segregation requirement refers to a group of substances, the particular segregation requirement applies to the goods allocated to the respective segregation group.

3.1.4.2 It is recognized that not all substances, mixtures, solutions or preparations falling within a segregation group are listed in the IMDG Code by name. These are shipped under N.O.S. entries. Although these N.O.S. entries are not themselves listed in the segregation groups (see 3.1.4.4), the consignor shall decide whether inclusion under the segregation group is appropriate and, if so, shall mention that fact in the transport document (see 5.4.1.5.11).

3.1.4.3 The segregation groups in this Code do not cover substances which fall outside the classification criteria of the Code. It is recognized that some non-hazardous substances have similar chemical properties as substances listed in the segregation groups. A consignor or the person responsible for packing the goods into a cargo transport unit who does have knowledge of the chemical properties of such non-dangerous goods may decide to implement the segregation provisions of a related segregation group on a voluntary basis.

3.1.4.4 The following segregation groups are identified.

#### 1 Acids

1052	Hydrogen fluoride, anhydrous*
1182	Ethyl chloroformate
1183	Ethylchlorosilane
1238	Methyl chloroformate
1242	Methylchlorosilane
1250	Methyltrichlorosilane
1295	Trichlorosilane
1298	Trimethylchlorosilane
1305	Vinyltrichlorosilane
1572	Cacodylic acid
1595	Dimethyl sulphate
1715	Acetic anhydride
1716	Acetyl bromide
1717	Acetyl chloride
1718	Butyl acid phosphate
1722	Allyl chloroformate
1723	Allyl iodide
1724	Allyltrichlorosilane, stabilized
1725	Aluminium bromide, anhydrous
1726	Aluminium chloride, anhydrous
1727	Ammonium hydrogendifluoride, solid
1728	Amyltrichlorosilane
1729	Anisoyl chloride
1730	Antimony pentachloride, liquid
1731	Antimony pentachloride solution
1732	Antimony pentafluoride



1733	Antimony trichloride
1736	Benzoyl chloride
1737	Benzyl bromide
1738	Benzyl chloride
1739	Benzyl chloroformate
1740	Hydrogendifluorides, n.o.s.
1742	Boron trifluoride acetic acid complex, liquid
1743	Boron trifluoride propionic acid complex, liquid
1744	Bromine or bromine solution
1745	Bromine pentafluoride
1746	Bromine trifluoride
1747	Butyltrichlorosilane
1750	Chloroacetic acid solution
1751	Chloroacetic acid, solid
1752	Chloroacetyl chloride
1753	Chlorophenyltrichlorosilane
1754	Chlorosulphonic acid (with or without sulphur trioxide)
1755	Chromic acid solution
1756	Chromic fluoride, solid
1757	Chromic fluoride solution
1758	Chromium oxychloride
1762	Cyclohexenyltrichlorosilane
1763	Cyclohexyltrichlorosilane
1764	Dichloroacetic acid
1765	Dichloroacetyl chloride
1766	Dichlorophenyltrichlorosilane
1767	Diethyldichlorosilane
1768	Difluorophosphoric acid, anhydrous
1769	Diphenyldichlorosilane
1770	Diphenylmethyl bromide
1771	Dodecyltrichlorosilane
1773	Ferric chloride, anhydrous
1775	Fluoroboric acid
1776	Fluorophosphoric acid, anhydrous
1777	Fluorosulphonic acid*
1778	Fluorosilicic acid
1779	Formic acid with more than 85% acid by mass
1780	Fumaryl chloride
1781	Hexadecyltrichlorosilane
1782	Hexafluorophosphoric acid
1784	Hexyltrichlorosilane
1786	Hydrofluoric acid and sulphuric acid mixture*
1787	Hydriodic acid*
1788	Hydrobromic acid*
1789	Hydrochloric acid*
1790	Hydrofluoric acid*
1792	Iodine monochloride, solid
1793	Isopropyl acid phosphate
1794	Lead sulphate with more than 3% free acid
1796	Nitrating acid mixture*

## Dangerous Goods List, special provisions and exceptions –

1798	Nitrohydrochloric acid*
1799	Nonyltrichlorosilane
1800	Octadecyltrichlorosilane
1801	Octyltrichlorosilane
1802	Perchloric acid with not more than 50% acid, by mass*
1803	Phenolsulphonic acid, liquid
1804	Phenyltrichlorosilane
1805	Phosphoric acid, solution
1806	Phosphorus pentachloride
1807	Phosphorus pentoxide
1808	Phosphorus tribromide
1809	Phosphorus trichloride
1810	Phosphorus oxychloride
1811	Potassium hydrogendifluoride, solid
1815	Propionyl chloride
1816	Propyltrichlorosilane
1817	Pyrosulphuryl chloride
1818	Silicon tetrachloride
1826	Nitrating acid mixture, spent*
1827	Stannic chloride, anhydrous
1828	Sulphur chlorides
1829	Sulphur trioxide, inhibited or sulphur trioxide, stabilized
1830	Sulphuric acid with more than 51% acid*
1831	Sulphuric acid, fuming*
1832	Sulphuric acid, spent*
1833	Sulphurous acid
1834	Sulphuryl chloride
1836	Thionyl chloride
1837	Thiophosphoryl chloride
1838	Titanium tetrachloride
1839	Trichloroacetic acid
1840	Zinc chloride solution
1848	Propionic acid with not less than 10% and less than 90% acid, by mass
1873	Perchloric acid with more than 50% but not more than 72% acid, by mass*
1898	Acetyl iodide
1902	Diisooctyl acid phosphate
1905	Selenic acid
1906	Sludge acid*
1938	Bromoacetic acid solution
1939	Phosphorus oxybromide
1940	Thioglycolic acid
2031	Nitric acid, other than red fuming*
2032	Nitric acid, red fuming*
2214	Phthalic anhydride with more than 0.05% of maleic anhydride
2215	Maleic anhydride
2218	Acrylic acid, inhibited
2225	Benzenesulphonyl chloride
2226	Benzotrichloride
2240	Chromosulphuric acid*
2262	Dimethylcarbamoyl chloride

---

2267	Dimethyl thiophosphoryl chloride
2305	Nitrobenzenesulphonic acid
2308	Nitrosylsulphuric acid, liquid*
2331	Zinc chloride, anhydrous
2353	Butyryl chloride
2395	Isobutyryl chloride
2407	Isopropyl chloroformate
2434	Dibenzylidichlorosilane
2435	Ethylphenyldichlorosilane
2437	Methylphenyldichlorosilane
2438	Trimethylacetyl chloride
2439	Sodium hydrogendifluoride
2440	Stannic chloride pentahydrate
2442	Trichloroacetyl chloride
2443	Vanadium oxytrichloride
2444	Vanadium tetrachloride
2475	Vanadium trichloride
2495	Iodine pentafluoride
2496	Propionic anhydride
2502	Valeryl chloride
2503	Zirconium tetrachloride
2506	Ammonium hydrogen sulphate
2507	Chloroplatinic acid, solid
2508	Molybdenum pentachloride
2509	Potassium hydrogen sulphate
2511	2-Chloropropionic acid
2513	Bromoacetyl bromide
2531	Methacrylic acid, stabilized
2564	Trichloroacetic acid solution
2571	Alkylsulphuric acids
2576	Phosphorus oxybromide, molten
2577	Phenylacetyl chloride
2578	Phosphorus trioxide
2580	Aluminium bromide solution
2581	Aluminium chloride solution
2582	Ferric chloride solution
2583	Alkylsulphonic acids, solid or arylsulphonic acids, solid with more than 5% free sulphuric acid
2584	Alkylsulphonic acids, liquid or arylsulphonic acids, liquid with more than 5% free sulphuric acid
2585	Alkylsulphonic acids, solid or arylsulphonic acids, solid with not more than 5% free sulphuric acid
2586	Alkylsulphonic acids, liquid or arylsulphonic acids, liquid with not more than 5% free sulphuric acid
2604	Boron trifluoride diethyl etherate
2626	Chloric acid, aqueous solution with not more than 10% chloric acid
2642	Fluoroacetic acid
2670	Cyanuric chloride
2691	Phosphorus pentabromide
2692	Boron tribromide
2698	Tetrahydrophthalic anhydrides with more than 0.05% maleic anhydride
2699	Trifluoroacetic acid
2739	Butyric anhydride

## Dangerous Goods List, special provisions and exceptions –

2740	Propyl chloroformate
2742	Chloroformates, toxic, corrosive, flammable, n.o.s.
2743	<i>n</i> -Butyl chloroformate
2744	Cyclobutyl chloroformate
2745	Chloromethyl chloroformate
2746	Phenyl chloroformate
2748	2-Ethylhexyl chloroformate
2751	Diethylthiophosphoryl chloride
2789	Acetic acid, glacial or acetic acid solution, more than 80% acid, by mass
2790	Acetic acid solution, more than 10% but not more than 80% acid, by mass
2794	Batteries, wet, filled with acid electric storage
2796	Sulphuric acid with not more than 51% acid or battery fluid, acid*
2798	Phenylphosphorus dichloride
2799	Phenylphosphorus thiodichloride
2802	Copper chloride
2817	Ammonium hydrogendifluoride solution
2819	Amyl acid phosphate
2820	Butyric acid
2823	Crotonic acid, solid
2826	Ethyl chlorothioformate
2829	Caproic acid
2834	Phosphorous acid
2851	Boron trifluoride dihydrate
2865	Hydroxylamine sulphate
2869	Titanium trichloride mixture
2879	Selenium oxychloride
2967	Sulphamic acid
2985	Chlorosilanes, flammable, corrosive, n.o.s.
2986	Chlorosilanes, corrosive, flammable, n.o.s.
2987	Chlorosilanes, corrosive, n.o.s.
2988	Chlorosilanes, water-reactive, flammable, corrosive, n.o.s.
3246	Methanesulphonyl chloride
3250	Chloroacetic acid, molten
3260	Corrosive solid, acidic, inorganic, n.o.s.
3261	Corrosive solid, acidic, organic, n.o.s.
3264	Corrosive liquid, acidic, inorganic, n.o.s.
3265	Corrosive liquid, acidic, organic, n.o.s.
3277	Chloroformates, toxic, corrosive, n.o.s.
3361	Chlorosilanes, toxic, corrosive, n.o.s.
3362	Chlorosilanes, toxic, corrosive, flammable, n.o.s.
3412	Formic acid with not less than 10% but not more than 85% acid by mass
3412	Formic acid with not less than 5% but not more than 10% acid by mass
3419	Boron trifluoride acetic acid complex, solid
3420	Boron trifluoride propionic acid complex, solid
3421	Potassium hydrogendifluoride solution
3425	Bromoacetic acid, solid
3453	Phosphoric acid, solid
3456	Nitrosylsulphuric acid, solid
3463	Propionic acid with not less than 90% acid by mass
3472	Crotonic acid, liquid
3498	Iodine monochloride, liquid

\* identifies strong acids

**2 Ammonium compounds**

- 0004 Ammonium picrate dry or wetted with less than 10% water, by mass
- 0222 Ammonium nitrate, with more than 0.2% combustible substances
- 0402 Ammonium perchlorate
- 1310 Ammonium picrate, wetted with not less than 10% water, by mass
- 1439 Ammonium dichromate
- 1442 Ammonium perchlorate
- 1444 Ammonium persulphate
- 1512 Zinc ammonium nitrite
- 1546 Ammonium arsenate
- 1630 Mercury ammonium chloride
- 1727 Ammonium hydrogendifluoride, solid
- 1835 Tetramethylammonium hydroxide solution
- 1843 Ammonium dinitro-*o*-cresolate, solid
- 1942 Ammonium nitrate with not more than 0.2% combustible substances
- 2067 Ammonium nitrate based fertilizer
- 2071 Ammonium nitrate based fertilizer
- 2073 Ammonia solution, relative density less than 0.880 at 15°C in water, with more than 35% but not more than 50% ammonia
- 2426 Ammonium nitrate, liquid (hot concentrated solution)
- 2505 Ammonium fluoride
- 2506 Ammonium hydrogen sulphate
- 2683 Ammonium sulphide solution
- 2687 Dicyclohexylammonium nitrite
- 2817 Ammonium hydrogendifluoride solution
- 2818 Ammonium polysulphide solution
- 2854 Ammonium fluorosilicate
- 2859 Ammonium metavanadate
- 2861 Ammonium polyvanadate
- 2863 Sodium ammonium vanadate
- 3375 Ammonium nitrate emulsion or suspension or gel intermediate for blasting explosives
- 3423 Tetramethylammonium hydroxide, solid
- 3424 Ammonium dinitro-*o*-cresolate solution

**3 Bromates**

- 1450 Bromates, inorganic, n.o.s.
- 1473 Magnesium bromate
- 1484 Potassium bromate
- 1494 Sodium bromate
- 2469 Zinc bromate
- 2719 Barium bromate
- 3213 Ammonium bromate
- 3213 Bromates, inorganic, aqueous solution, n.o.s.

**4 Chlorates**

- 1445 Barium chlorate, solid
- 1452 Calcium chlorate
- 1458 Chlorate and borate mixture
- 1459 Chlorate and magnesium chloride mixture, solid
- 1461 Chlorates, inorganic, n.o.s.
- 1485 Potassium chlorate

Dangerous Goods List, special provisions and exceptions –

---

- 1495 Sodium chlorate
- 1506 Strontium chlorate
- 1513 Zinc chlorate
- 2427 Potassium chlorate, aqueous solution
- 2428 Sodium chlorate, aqueous solution
- 2429 Calcium chlorate, aqueous solution
- 2573 Thallium chlorate
- 2721 Copper chlorate
- 2723 Magnesium chlorate
- 3405 Barium chlorate solution
- 3407 Chlorate and magnesium chloride mixture solution
- 5 Chlorites**
  - 1453 Calcium chlorite
  - 1462 Chlorites, inorganic, n.o.s.
  - 1496 Sodium chlorite
  - 1908 Chlorite solution
- 6 Cyanides**
  - 1541 Acetone cyanhydrin, stabilized
  - 1565 Barium cyanide
  - 1575 Calcium cyanide
  - 1587 Copper cyanide
  - 1588 Cyanides, inorganic, solid, n.o.s.
  - 1620 Lead cyanide
  - 1626 Mercuric potassium cyanide
  - 1636 Mercury cyanide
  - 1642 Mercury oxycyanide, desensitized
  - 1653 Nickel cyanide
  - 1679 Potassium cuprocyanide
  - 1680 Potassium cyanide, solid
  - 1684 Silver cyanide
  - 1689 Sodium cyanide, solid
  - 1694 Bromobenzyl cyanides, liquid
  - 1713 Zinc cyanide
  - 1889 Cyanogen bromide
  - 1935 Cyanide solution, n.o.s.
  - 2205 Adiponitrile
  - 2316 Sodium cuprocyanide, solid
  - 2317 Sodium cuprocyanide solution
  - 3413 Potassium cyanide solution
  - 3414 Sodium cyanide solution
  - 3449 Bromobenzyl cyanides, solid
- 7 Heavy metals and their salts (including their organometallic compounds)**
  - 0129 Lead azide, wetted, with not less than 20% water, or mixture of alcohol and water, by mass
  - 0130 Lead styphnate (lead trinitroresorcinate), wetted with not less than 20% water, or mixture of alcohol and water, by mass
  - 0135 Mercury fulminate, wetted with not less than 20% water, or mixture of alcohol and water, by mass
  - 1347 Silver picrate, wetted with not less than 30% water, by mass
  - 1366 Diethylzinc
  - 1370 Dimethylzinc

---

1389	Alkali metal amalgam, liquid
1392	Alkaline earth metal amalgam, liquid
1435	Zinc ashes
1436	Zinc dust or zinc powder
1469	Lead nitrate
1470	Lead perchlorate, solid
1493	Silver nitrate
1512	Zinc ammonium nitrite
1513	Zinc chlorate
1514	Zinc nitrate
1515	Zinc permanganate
1516	Zinc peroxide
1587	Copper cyanide
1616	Lead acetate
1617	Lead arsenates
1618	Lead arsenites
1620	Lead cyanide
1623	Mercuric arsenate
1624	Mercuric chloride
1625	Mercuric nitrate
1626	Mercuric potassium cyanide
1627	Mercurous nitrate
1629	Mercury acetate
1630	Mercury ammonium chloride
1631	Mercury benzoate
1634	Mercury bromides
1636	Mercury cyanide
1637	Mercury gluconate
1638	Mercury iodide
1639	Mercury nucleate
1640	Mercury oleate
1641	Mercury oxide
1642	Mercury oxycyanide, desensitized
1643	Mercury potassium iodide
1644	Mercury salicylate
1645	Mercury sulphate
1646	Mercury thiocyanate
1649	Motor fuel anti-knock mixture
1653	Nickel cyanide
1674	Phenylmercuric acetate
1683	Silver arsenite
1684	Silver cyanide
1712	Zinc arsenate and zinc arsenite mixture
1713	Zinc cyanide
1714	Zinc phosphide
1794	Lead sulphate with more than 3% free acid
1838	Titanium tetrachloride
1840	Zinc chloride solution
1872	Lead dioxide
1894	Phenylmercuric hydroxide

## Dangerous Goods List, special provisions and exceptions –

- |      |  |
|------|--|
| 1895 | Phenylmercuric nitrate   |
| 1931 | Zinc hydrosulphite   |
| 1931 | Zinc dithionite  |
| 2024 | Mercury compound, liquid, n.o.s.   |
| 2025 | Mercury compound, solid, n.o.s.  |
| 2026 | Phenylmercuric compound, n.o.s.  |
| 2291 | Lead compound, soluble, n.o.s.   |
| 2331 | Zinc chloride, anhydrous   |
| 2441 | Titanium trichloride, pyrophoric or titanium trichloride mixture, pyrophoric |
| 2469 | Zinc bromate   |
| 2546 | Titanium powder, dry   |
| 2714 | Zinc resinate  |
| 2777 | Mercury based pesticide, solid, toxic  |
| 2778 | Mercury based pesticide, liquid, flammable, toxic                            |
| 2809 | Mercury  |
| 2855 | Zinc fluorosilicate  |
| 2869 | Titanium trichloride mixture   |
| 2878 | Titanium, sponge granules or titanium, sponge powders                        |
| 2881 | Metal catalyst, dry  |
| 2989 | Lead phosphite, dibasic  |
| 3011 | Mercury based pesticide, liquid, toxic, flammable                            |
| 3012 | Mercury based pesticide, liquid, toxic                                       |
| 3089 | Metal powder, flammable, n.o.s.  |
| 3174 | Titanium disulphide  |
| 3181 | Metal salts of organic compounds, flammable, n.o.s.                          |
| 3189 | Metal powder, self-heating, n.o.s.   |
| 3401 | Alkali metal amalgam, solid  |
| 3402 | Alkaline earth metal amalgam, solid  |
| 3408 | Lead perchlorate solution  |
| 3483 | Motor fuel anti-knock mixture, flammable                                     |
- 8 Hypochlorites**
- |      |   |
|------|---|
| 1471 | Lithium hypochlorite  |
| 1748 | Calcium hypochlorite mixture  |
| 1791 | Hypochlorite solution   |
| 2208 | Calcium hypochlorite mixture, dry with more than 10% but not more than 39% available chlorine   |
| 2741 | Barium hypochlorite with more than 22% available chlorine   |
| 2880 | Calcium hypochlorite, hydrated or calcium hypochlorite, hydrated mixture with not less than 5.5% but not more than 16% water                        |
| 3212 | Hypochlorites, inorganic, n.o.s.  |
| 3255 | <i>tert</i> -Butyl hypochlorite   |
| 3485 | Calcium hypochlorite, dry, corrosive or calcium hypochlorite mixture, dry, corrosive with more than 39% available chlorine (8.8% available oxygen)  |
| 3486 | Calcium hypochlorite mixture, dry, corrosive with more than 10% but not more than 39% available chlorine  |
| 3487 | Calcium hypochlorite, hydrated, corrosive or calcium hypochlorite, hydrated mixture, corrosive, with not less than 5.5% but not more than 16% water |
- 9 Lead and its compounds**
- |      |  |
|------|--|
| 0129 | Lead azide, wetted with not less than 20% water, or mixture of alcohol and water, by mass              |
| 0130 | Lead styphnate, wetted with not less than 20% water, or mixture of alcohol and water, by mass          |
| 0130 | Lead trinitroresorcinat, wetted with not less than 20% water, or mixture of alcohol and water, by mass |



1469	Lead nitrate
1470	Lead perchlorate, solid
1616	Lead acetate
1617	Lead arsenates
1618	Lead arsenites
1620	Lead cyanide
1649	Motor fuel anti-knock mixture
1794	Lead sulphate with more than 3% free acid
1872	Lead dioxide
2291	Lead compound, soluble, n.o.s.
2989	Lead phosphide, dibasic
3408	Lead perchlorate solution
3483	Motor fuel anti-knock mixture, flammable
<b>10</b>	<b>Liquid halogenated hydrocarbons</b>
1099	Allyl bromide
1100	Allyl chloride
1107	Amyl chloride
1126	1-Bromobutane
1127	Chlorobutanes
1134	Chlorobenzene
1150	1,2-Dichloroethylene
1152	Dichloropentanes
1184	Ethylene dichloride
1278	1-Chloropropane
1279	1,2-Dichloropropane
1303	Vinylidene chloride, stabilized
1591	<i>o</i> -Dichlorobenzene
1593	Dichloromethane
1605	Ethylene dibromide
1647	Methyl bromide and ethylene dibromide mixture, liquid
1669	Pentachloroethane
1701	Xylyl bromide
1702	1,1,2,2-Tetrachloroethane
1710	Trichloroethylene
1723	Allyl iodide
1737	Benzyl bromide
1738	Benzyl chloride
1846	Carbon tetrachloride
1887	Bromochloromethane
1888	Chloroform
1891	Ethyl bromide
1897	Tetrachloroethylene
1991	Chloroprene, stabilized
2234	Chlorobenzotrifluorides
2238	Chlorotoluenes
2279	Hexachlorobutadiene
2321	Trichlorobenzenes, liquid
2322	Trichlorobutene
2339	2-Bromobutane
2341	1-Bromo-3-methylbutane

## Dangerous Goods List, special provisions and exceptions –

2342	Bromomethylpropanes
2343	2-Bromopentane
2344	Bromopropanes
2356	2-Chloropropane
2362	1,1-Dichloroethane
2387	Fluorobenzene
2388	Fluorotoluenes
2390	2-Iodobutane
2391	Iodomethylpropanes
2392	Iodopropanes
2456	2-Chloropropene
2504	Tetrabromoethane
2515	Bromoform
2554	Methylallyl chloride
2644	Methyl iodide
2646	Hexachlorocyclopentadiene
2664	Dibromomethane
2688	1-Bromo-3-chloropropane
2831	1,1,1-Trichloroethane
2872	Dibromochloropropanes
<b>11</b>	<b>Mercury and mercury compounds</b>
0135	Mercury fulminate, wetted with not less than 20% water
1389	Alkali metal amalgam, liquid
1392	Alkaline earth metal amalgam, liquid
1623	Mercuric arsenate
1624	Mercuric chloride
1625	Mercuric nitrate
1626	Mercuric potassium cyanide
1627	Mercurous nitrate
1629	Mercury acetate
1630	Mercury ammonium chloride
1631	Mercury benzoate
1634	Mercury bromides
1636	Mercury cyanide
1637	Mercury gluconate
1638	Mercury iodide
1639	Mercury nucleate
1640	Mercury oleate
1641	Mercury oxide
1642	Mercury oxycyanide, desensitized
1643	Mercury potassium iodide
1644	Mercury salicylate
1645	Mercury sulphate
1646	Mercury thiocyanate
1894	Phenylmercuric hydroxide
1895	Phenylmercuric nitrate
2024	Mercury compound, liquid, n.o.s.
2025	Mercury compound, solid, n.o.s.
2026	Phenylmercuric compound, n.o.s.
2777	Mercury based pesticide, solid, toxic

- 2778 Mercury based pesticide, liquid, flammable, toxic  
 2809 Mercury  
 3011 Mercury based pesticide, liquid, toxic, flammable  
 3012 Mercury based pesticide, liquid, toxic  
 3401 Alkali metal amalgam, solid  
 3402 Alkaline earth metal amalgam, solid
- 12 Nitrites and their mixtures**
- 1487 Potassium nitrate and sodium nitrite mixture  
 1488 Potassium nitrite  
 1500 Sodium nitrite  
 1512 Zinc ammonium nitrite  
 2627 Nitrites, inorganic, n.o.s.  
 2726 Nickel nitrite  
 3219 Nitrites, inorganic, aqueous solution, n.o.s
- 13 Perchlorates**
- 1442 Ammonium perchlorate  
 1447 Barium perchlorate, solid  
 1455 Calcium perchlorate  
 1470 Lead perchlorate, solid  
 1475 Magnesium perchlorate  
 1481 Perchlorates, inorganic, n.o.s.  
 1489 Potassium perchlorate  
 1502 Sodium perchlorate  
 1508 Strontium perchlorate  
 3211 Perchlorates, inorganic, aqueous solution, n.o.s.  
 3406 Barium perchlorate solution  
 3408 Lead perchlorate solution
- 14 Permanganates**
- 1448 Barium permanganate  
 1456 Calcium permanganate  
 1482 Permanganates, inorganic, n.o.s.  
 1490 Potassium permanganate  
 1503 Sodium permanganate  
 1515 Zinc permanganate  
 3214 Permanganates, inorganic, aqueous solution, n.o.s.
- 15 Powdered metals**
- 1309 Aluminium powder, coated  
 1326 Hafnium powder, wetted with not less than 25% water  
 1352 Titanium powder, wetted with not less than 25% water  
 1358 Zirconium powder, wetted with not less than 25% water  
 1383 Pyrophoric alloy or pyrophoric metal, n.o.s.  
 1396 Aluminium powder, uncoated  
 1398 Aluminium silicon powder, uncoated  
 1418 Magnesium powder  
 1435 Zinc ashes  
 1436 Zinc dust or zinc powder  
 1854 Barium alloys, pyrophoric  
 2008 Zirconium powder, dry  
 2009 Zirconium, dry, sheets, strip or coiled wire  
 2545 Hafnium powder, dry

## Dangerous Goods List, special provisions and exceptions –

2546	Titanium powder, dry
2878	Titanium sponge powders
2881	Metal catalyst, dry
2950	Magnesium granules, coated, particle size not less than 149 microns
3078	Cerium, turnings or gritty powder
3089	Metal powder, flammable, n.o.s.
3170	Aluminium smelting by-products
3189	Metal powder, self-heating, n.o.s.
<b>16</b>	<b>Peroxides</b>
1449	Barium peroxide
1457	Calcium peroxide
1472	Lithium peroxide
1476	Magnesium peroxide
1483	Peroxides, inorganic, n.o.s.
1491	Potassium peroxide
1504	Sodium peroxide
1509	Strontium peroxide
1516	Zinc peroxide
2014	Hydrogen peroxide, aqueous solution, 20–60%
2015	Hydrogen peroxide, aqueous solution, stabilized
2466	Potassium superoxide
2547	Sodium superoxide
3149	Hydrogen peroxide and peroxyacetic acid mixture
3377	Sodium perborate monohydrate
3378	Sodium carbonate peroxyhydrate
<b>17</b>	<b>Azides</b>
0129	Lead azide, wetted
0224	Barium azide, dry
1571	Barium azide, wetted
1687	Sodium azide
<b>18</b>	<b>Alkalis</b>
1005	Ammonia, anhydrous
1160	Dimethylamine, aqueous solution
1163	Dimethylhydrazine, unsymmetrical
1235	Methylamine, aqueous solution
1244	Methylhydrazine
1382	Potassium sulphide, anhydrous or potassium sulphide with less than 30% water of crystallization
1385	Sodium sulphide, anhydrous or sodium sulphide with less than 30% water of crystallization
1604	Ethylenediamine
1719	Caustic alkali liquid, n.o.s.
1813	Potassium hydroxide, solid
1814	Potassium hydroxide solution
1819	Sodium aluminate solution
1823	Sodium hydroxide, solid
1824	Sodium hydroxide solution
1825	Sodium monoxide
1835	Tetramethylammonium hydroxide solution
1847	Potassium sulphide, hydrated with not less than 30% water of crystallization
1849	Sodium sulphide, hydrated with not less than 30% water
1907	Soda lime with more than 4% sodium hydroxide

1922	Pyrrolidine
2029	Hydrazine, anhydrous
2030	Hydrazine, aqueous solution with more than 37% hydrazine, by mass
2033	Potassium monoxide
2073	Ammonia solution relative density less than 0.880 at 15°C in water, with more than 35% but not more than 50% ammonia
2079	Diethylenetriamine
2259	Triethylenetetramine
2270	Ethylamine, aqueous solution, with not less than 50% but not more than 70% ethylamine
2318	Sodium hydrosulphide with less than 25% water of crystallization
2320	Tetraethylenepentamine
2379	1,3-Dimethylbutylamine
2382	Dimethylhydrazine, symmetrical
2386	1-Ethylpiperidine
2399	1-Methylpiperidine
2401	Piperidine
2491	Ethanolamine or ethanolamine solution
2579	Piperazine
2671	Aminopyridines
2672	Ammonia solution relative density between 0.880 and 0.957 at 15°C in water, with more than 10% but not more than 35% ammonia, by mass
2677	Rubidium hydroxide solution
2678	Rubidium hydroxide, solid
2679	Lithium hydroxide solution
2680	Lithium hydroxide
2681	Caesium hydroxide solution
2682	Caesium hydroxide
2683	Ammonium sulphide solution
2733	Amines, flammable, corrosive, n.o.s. or polyamines, flammable, corrosive, n.o.s.
2734	Amines, liquid, corrosive, flammable, n.o.s. or polyamines, liquid, corrosive, flammable, n.o.s.
2735	Amines, liquid, corrosive, n.o.s. or polyamines, liquid, corrosive, n.o.s.
2795	Batteries, wet, filled with alkali electric storage
2797	Battery fluid, alkali
2818	Ammonium polysulphide solution
2949	Sodium hydrosulphide, solid with not less than 25% water of crystallization
3028	Batteries, dry, containing potassium hydroxide, solid electric storage
3073	Vinylpyridines, stabilized
3253	Disodium trioxosilicate
3259	Amines, solid, corrosive, n.o.s. or polyamines, solid, corrosive, n.o.s.
3262	Corrosive solid, basic, inorganic, n.o.s.
3263	Corrosive solid, basic, organic, n.o.s.
3266	Corrosive liquid, basic, inorganic, n.o.s.
3267	Corrosive liquid, basic, organic, n.o.s.
3293	Hydrazine, aqueous solution with not more than 37% hydrazine, by mass
3318	Ammonia solution relative density less than 0.880 at 15°C in water, with more than 50% ammonia
3320	Sodium borohydride and sodium hydroxide solution with not more than 12% sodium borohydride and not more than 40% sodium hydroxide, by mass
3423	Tetramethylammonium hydroxide, solid
3484	Hydrazine aqueous solution, flammable, with more than 37% hydrazine, by mass

## Chapter 3.2

### *Dangerous Goods List*

---

#### 3.2.1 Structure of the Dangerous Goods List

The Dangerous Goods List is divided into 18 columns as follows:

- Column 1 **UN No.** – this column contains the United Nations Number assigned to a dangerous good by the United Nations Sub-Committee of Experts on the Transport of Dangerous Goods (UN List).
- Column 2 **Proper Shipping Name (PSN)** – this column contains the Proper Shipping Names in upper-case characters, which may have to be followed by additional descriptive text in lower-case characters (see 3.1.2). Proper Shipping Names may be shown in plural where isomers of similar classification exist. Hydrates may be included under the Proper Shipping Name for the anhydrous substances. Unless otherwise indicated for an entry in the Dangerous Goods List, the word “SOLUTION” in a Proper Shipping Name means one or more named dangerous goods dissolved in a liquid that is not otherwise subject to this Code. When a flashpoint is mentioned in this column, the data is based on closed-cup (c.c.) methods.
- Column 3 **Class or division** – this column contains the class and, in the case of class 1, the division and the compatibility group assigned to the substance or article according to the classification system described in part 2, chapter 2.1.
- Column 4 **Subsidiary risk(s)** – this column contains the class number(s) of any subsidiary risk(s) which have been identified by applying the classification system described in part 2. This column also identifies a dangerous good as a marine pollutant as follows:
- P – Marine pollutant: a non-exhaustive list of known marine pollutants, based on previous criteria and assignment
- Column 5 **Packing group** – this column contains the packing group number (i.e., I, II or III) where assigned to the substance or article. If more than one packing group is indicated for the entry, the packing group of the substance or formulation to be transported shall be determined, based on its properties, through application of the hazard grouping criteria as provided in part 2.
- Column 6 **Special provisions** – this column contains a number referring to any special provision(s) indicated in chapter 3.3 that is relevant to the substance or article. Special provisions apply to all packing groups permitted for a particular substance or article unless the wording makes it otherwise apparent. The special provision numbers specific to the sea mode start from 900.
- Note:** When a special provision is no longer needed, this special provision is deleted but the special provision number is not allocated again, in order not to confuse the users of this Code. For this reason, some of the numbers are missing.
- Column 7a **Limited quantities:** this column provides the maximum quantity per inner packaging or article for transporting dangerous goods as limited quantities in accordance with chapter 3.4.
- Column 7b **Excepted quantities:** this column provides an alpha-numeric code described in sub-section 3.5.1.2 which indicates the maximum quantity per inner and outer packaging for transporting dangerous goods as excepted quantities in accordance with chapter 3.5.
- Column 8 **Packing instructions** – this column contains alpha-numeric codes which refer to the relevant packing instruction(s) in 4.1.4. The packing instructions indicate the packagings (including large packagings) which may be used for the transport of substances and articles.
- A code including the letter “P” refers to packing instructions for the use of packagings described in chapter 6.1, 6.2 or 6.3.
- A code including the letters “LP” refers to packing instructions for the use of large packagings described in chapter 6.6.

- When a code including the letter(s) "P" or "LP" is not provided, it means that the substance is not allowed in that type of packaging.
- Column 9 **Special packing provisions** – this column contains alpha-numeric codes which refer to the relevant special packing provisions specified in 4.1.4. The special packing provisions indicate the packagings (including large packagings).
- A special packing provision including the letters "PP" refers to a special packing provision applicable to the use of a packing instruction bearing the Code "P" in 4.1.4.1.
- A special packing provision including the letter "L" refers to a special packing provision applicable to a packing instruction bearing the code "LP" in 4.1.4.3.
- Column 10 **IBC packing instructions** – this column contains alpha-numeric codes that refer to the relevant IBC instruction, which indicates the type of IBC that shall be used for the transport of the substance under reference. A code including the letters "IBC" refers to packing instructions for the use of IBCs described in chapter 6.5. When a code is not provided, it means the substance is not authorized in IBC.
- Column 11 **IBC special provisions** – this column contains an alpha-numeric code, including the letter "B", which refers to special packing provisions applicable to the use of packing instructions bearing the code "IBC" in 4.1.4.2.
- Column 12 [Reserved]
- Column 13 **Tank and bulk container instructions** – this column contains T codes (see 4.2.5.2.6) applicable to the transport of dangerous goods in portable tanks and road tank vehicles.
- When a T code is not provided in this column, it means that the dangerous goods are not authorized for transport in tanks unless specifically approved by the competent authority.
- A code including the letters BK refers to type of bulk containers used for the transport of bulk goods described in chapter 4.3 and chapter 6.9.
- The gases authorized for transport in MEGCs are indicated in the column "MEGC" in Tables 1 and 2 of packing instruction P200 in 4.1.4.1.
- Column 14 **Tank special provisions** – this column contains TP notes (see 4.2.5.3) applicable to the transport of dangerous goods in portable tanks and road tank vehicles. The TP notes specified in this column apply to the portable tanks specified in both columns 12 and 13.
- Column 15 **EmS** – this column refers to the relevant emergency schedules for FIRE and SPILLAGE in "The EmS Guide – Emergency Response Procedures for Ships Carrying Dangerous Goods".
- The first EmS code refers to the relevant Fire Schedule (e.g., Fire Schedule Alfa "F-A" General Fire Schedule).
- The second EmS code refers to the relevant Spillage Schedule (e.g., Spillage Schedule Alfa "S-A" Toxic Substances).
- Underlined EmS codes (special cases) indicate a substance, material or article for which additional advice is given in the emergency response procedures.
- For dangerous goods offered for transport under N.O.S. entries or other generic entries, the most relevant emergency response procedures may vary with the properties of the hazardous constituents. As a consequence, shippers may have to declare different EmS codes from those indicated, if, to their knowledge, such codes are more appropriate.
- The provisions in this column are not mandatory.
- Column 16 **Stowage and segregation** – this column contains the stowage and segregation provisions as prescribed in part 7.
- Column 17 **Properties and observations** – this column contains properties of and observations on the dangerous goods listed. The provisions in this column are not mandatory.
- Properties of most gases include an indication of its density in relation to air. The figures in brackets give the density relative to air.
- .1 "lighter than air" when the vapour density is down to half that of air;
  - .2 "much lighter than air" when the vapour density is less than half that of air;
  - .3 "heavier than air" when the vapour density is up to twice that of air; and
  - .4 "much heavier than air" when the vapour density is more than twice that of air.

**Dangerous Goods List, special provisions and exceptions –**

---

When explosive limits are given, these refer to the volume percentage of the vapour of the substance when mixed with air.

The ease and extent to which different liquids mix with water varies greatly and most entries have included an indication of miscibility. In these cases "miscible with water" normally means capable of being mixed with water in all proportions to form a completely homogeneous liquid.

Column 18 **UN No.** – see column 1.

### 3.2.2 Abbreviations and symbols

The following abbreviations and symbols are used in the Dangerous Goods List and have the meanings shown:

Abbreviation/symbol	Column	Meaning
N.O.S.	2	Not otherwise specified
P	4	Marine pollutant



## Chapter 3.3

### *Special provisions applicable to certain substances, materials or articles*

- 3.3.1 When column 6 of the Dangerous Goods List indicates that a special provision is relevant to a dangerous good, the meaning and requirement(s) of that special provision are as set out below:
- 16 Samples of new or existing explosive substances or articles may be transported as directed by the competent authority for purposes including: testing, classification, research and development, quality control, or as a commercial sample. Explosive samples which are not wetted or desensitized shall be limited to 10 kg in small packages as specified by the competent authority. Explosive samples which are wetted or desensitized shall be limited to 25 kg.
- 23 Even though this substance has a flammability hazard, it only exhibits such hazard under extreme fire conditions in confined areas.
- 26 This substance is not permitted for transport in portable tanks, or intermediate bulk containers with a capacity exceeding 450 l, due to the potential initiation of an explosion when transported in large volumes.
- 28 This substance may be transported under the provisions of class 4.1 only if it is so packaged that the percentage of diluent will not fall below that stated, at any time during transport (see 2.4.2.4).
- 29 The packages, including bales, are exempt from labelling provided that they are marked with the appropriate class (e.g., "class 4.2"). Packages, with the exception of bales, shall also display the Proper Shipping Name and the UN Number of the substance that they contain in accordance with 5.2.1. In any case, the packages, including bales, are exempt from class marking provided that they are loaded in a cargo transport unit and that they contain goods to which only one UN Number has been assigned. The cargo transport units in which the packages, including bales, are loaded shall display any relevant labels, placards and marks in accordance with chapter 5.3.
- 32 When in any other form, this substance is not subject to the provisions of this Code.
- 37 When coated, this substance is not subject to the provisions of this Code.
- 38 This substance, when it contains not more than 0.1% calcium carbide, is not subject to the provisions of this Code.
- 39 This substance, when it contains less than 30% or not less than 90% silicon, is not subject to the provisions of this Code.
- 43 When offered for transport as pesticides, these substances shall be transported under the relevant pesticide entry and in accordance with the relevant pesticide provisions (see 2.6.2.3 and 2.6.2.4).
- 45 Antimony sulphides and oxides which contain not more than 0.5% of arsenic, calculated on the total mass, are not subject to the provisions of this Code.
- 47 Ferricyanides and ferrocyanides are not subject to the provisions of this Code.
- 59 These substances, when they contain not more than 50% magnesium, are not subject to the provisions of this Code.
- 61 The technical name, which shall supplement the Proper Shipping Name, shall be the ISO common name, or other name listed in 'The WHO Recommended Classification of Pesticides by Hazard and Guidelines to Classification' or the name of the active substance (see also 3.1.2.8.1.1).
- 62 This substance, when it contains not more than 4% sodium hydroxide, is not subject to the provisions of this Code.
- 63 The division of class 2 and the subsidiary risks depend on the nature of the contents of the aerosol dispenser. The following provisions shall apply:
- .1 Class 2.1 applies if the contents include 85% by mass or more flammable components and the chemical heat of combustion is 30 kJ/g or more;
  - .2 Class 2.2 applies if the contents contain 1% by mass or less flammable components and the heat of combustion is less than 20 kJ/g.

Dangerous Goods List, special provisions and exceptions –

---

- .3 Otherwise the product shall be classified as tested by the tests described in the United Nations *Manual of Tests and Criteria*, Part III, section 31. Extremely flammable and flammable aerosols shall be classified in class 2.1; non-flammable in class 2.2;
  - .4 Gases of class 2.3 shall not be used as a propellant in an aerosol dispenser;
  - .5 Where the contents other than the propellant of aerosol dispensers to be ejected are classified as class 6.1 packing groups II or III or class 8 packing groups II or III, the aerosol shall have a subsidiary risk of class 6.1 or class 8;
  - .6 Aerosols with contents meeting the criteria for packing group I for toxicity or corrosivity shall be prohibited from transport;
  - .7 Except for consignments transported in limited quantities (see chapter 3.4), packages containing aerosols shall bear labels for the primary risk and for the subsidiary risk(s), if any.
- Flammable components are flammable liquids, flammable solids or flammable gases and gas mixtures as defined in Notes 1 to 3 of sub-section 31.1.3 of Part III of the United Nations *Manual of Tests and Criteria*. This designation does not cover pyrophoric, self-heating or water-reactive substances. The chemical heat of combustion shall be determined by one of the following methods: ASTM D 240, ISO/FDIS 13943:1999 (E/F) 86.1 to 86.3 or NFPA 30B.
- 65 Hydrogen peroxide aqueous solutions with less than 8% hydrogen peroxide are not subject to the provisions of this Code.
  - 66 Mercurous chloride shall be transported under UN 3077 and cinnabar is not subject to the provisions of this Code.
  - 76 The transport of this substance shall be prohibited except with special authorization granted by the competent authority of the country concerned.
  - 105 Nitrocellulose meeting the descriptions of UN 2556 or UN 2557 may be classified in class 4.1.
  - 113 The transport of chemically unstable mixtures is prohibited.
  - 117 Only regulated when transported by sea.
  - 119 Refrigerating machines and refrigerating machinery components including machines or other appliances which have been designed for the specific purpose of keeping food or other items at a low temperature in an internal compartment, and air-conditioning units. Refrigerating machines and refrigerating machine components are not subject to the provisions of this Code if they contain less than 12 kg of gas in class 2.2 or less than 12 ℓ of ammonia solution (UN 2672).
  - 122 The subsidiary risk(s), the control and emergency temperatures, if any, and the generic entry number for each of the currently assigned organic peroxide formulations are given in 2.5.3.2.4.
  - 127 Other inert material or inert material mixture may be used at the discretion of the competent authority, provided this inert material has identical phlegmatizing properties.
  - 131 The phlegmatized substance shall be significantly less sensitive than dry PETN.
  - 133 If over-confined in packagings, this substance may exhibit explosive behaviour. Packagings authorized under packing instruction P409 are intended to prevent over-confinement. When a packaging other than those prescribed under packing instruction P409 is authorized by the competent authority of the country of origin in accordance with 4.1.3.7, the package shall bear an "EXPLOSIVE" subsidiary risk label (Model No. 1, see 5.2.2.2.2) unless the competent authority of the country of origin has permitted this label to be dispensed with for the specific packaging employed because test data have proved that the substance in this packaging does not exhibit explosive behaviour (see 5.4.1.5.5.1). The provisions of 7.2.3.3, 7.1.3.1 and 7.1.4.4 shall also be considered.
  - 135 The dihydrated sodium salt of dichloroisocyanuric acid is not subject to the provisions of this Code.
  - 138 *p*-Bromobenzyl cyanide is not subject to the provisions of this Code.
  - 141 Products which have undergone sufficient heat treatment so that they present no hazard during transport are not subject to the provisions of this Code.
  - 142 Solvent-extracted soya bean meal containing not more than 1.5% oil and 11% moisture, being substantially free from flammable solvents, which is accompanied by a certificate from the shipper stating that the substance, as offered for shipment, meets this requirement is not subject to the provisions of this Code.
  - 144 An aqueous solution containing not more than 24% alcohol by volume is not subject to the provisions of this Code.
  - 145 Alcoholic beverages of packing group III, when transported in receptacles of 250 ℓ or less, are not subject to the provisions of this Code.
  - 152 The classification of this substance will vary with particle size and packaging, but borderlines have not been experimentally determined. Appropriate classifications shall be made as required by 2.1.3.

*Chapter 3.3 – Special provisions applicable to certain substances, materials or articles*

- 153 This entry applies only if it is demonstrated, on the basis of tests, that the substance, when in contact with water, is not combustible nor shows a tendency to auto-ignition and that the mixture of gases evolved is not flammable.
- 163 A substance specifically listed by name in the Dangerous Goods List shall not be transported under this entry. Materials transported under this entry may contain 20% or less nitrocellulose provided the nitrocellulose contains not more than 12.6% nitrogen (by dry mass).
- 168 Asbestos which is immersed or fixed in a natural or artificial binder (such as cement, plastics, asphalt, resins or mineral ore) in such a way that no escape of hazardous quantities of respirable asbestos fibres can occur during transport is not subject to the provisions of this Code. Manufactured articles containing asbestos and not meeting this provision are nevertheless not subject to the provisions of this Code when packaged so that no escape of hazardous quantities of respirable asbestos fibres can occur during transport.
- 169 Phthalic anhydride in the solid state and tetrahydrophthalic anhydride, with not more than 0.05% maleic anhydride, are not subject to the provisions of this Code. Phthalic anhydride molten at a temperature above its flashpoint, with not more than 0.05% maleic anhydride, shall be classified under UN 3256.
- 172 Radioactive material with a subsidiary risk shall:
- .1 be labelled with subsidiary risk labels corresponding to each subsidiary risk exhibited by the material; corresponding placard shall be affixed to transport units in accordance with the relevant provisions of 5.3.1;
  - .2 be allocated to packing groups I, II or III, as and if appropriate, by application of the grouping criteria provided in part 2 corresponding to the nature of the predominant subsidiary risk.
- The description required in 5.4.1.5.7.1.2 shall include a description of these subsidiary risks (e.g., "Subsidiary risk: 3, 6.1"), the name of the constituents which most predominantly contribute to this (these) subsidiary risk(s), and, where applicable, the packing group. For packing, see also 4.1.9.1.5.
- For thorium nitrate solid and uranium nitrate solid, the subsidiary risk is 5.1. For uranyl nitrate hexahydrate solution and uranium hexafluoride, the subsidiary risk is 8. For pyrophoric uranium metal and pyrophoric thorium metal, the subsidiary risk is 4.2.
- 177 Barium sulphate is not subject to the provisions of this Code.
- 178 This entry shall be used only when no other appropriate entry exists in the list, and only with the approval of the competent authority of the country of origin.
- 181 Packages containing this type of substance shall bear the "EXPLOSIVE" subsidiary risk label (Model No. 1, see 5.2.2.2.2) unless the competent authority of the country of origin has permitted this label to be dispensed with for the specific packaging employed because test data have proved that the substance in this packaging does not exhibit explosive behaviour (see 5.4.1.5.5.1). The provisions of 7.2.3.3 shall also be considered.
- 182 The group of alkali metals includes lithium, sodium, potassium, rubidium and caesium.
- 183 The group of alkaline earth metals includes magnesium, calcium, strontium and barium.
- 186 In determining the ammonium nitrate content, all nitrate ions for which a molecular equivalent of ammonium ions is present in the mixture shall be calculated as ammonium nitrate.
- 188 Cells and batteries offered for transport are not subject to other provisions of this Code if they meet the following:
- .1 For a lithium metal or lithium alloy cell, the lithium content is not more than 1 g, and for a lithium-ion cell, the watt-hour rating is not more than 20 W h;
  - .2 For a lithium metal or lithium alloy battery, the aggregate lithium content is not more than 2 g, and for a lithium-ion battery, the watt-hour rating is not more than 100 W h. Lithium-ion batteries subject to this provision shall be marked with the watt-hour rating on the outside case, except those manufactured before 1 January 2009;
  - .3 Each cell or battery meets the provisions of 2.9.4.1 and 2.9.4.5;
  - .4 Cells and batteries, except when installed in equipment, shall be packed in inner packagings that completely enclose the cell or battery. Cells and batteries shall be protected so as to prevent short circuits. This includes protection against contact with conductive materials within the same packaging that could lead to a short circuit. The inner packagings shall be packed in strong outer packagings which conform to the provisions of 4.1.1.1, 4.1.1.2, and 4.1.1.5.

Dangerous Goods List, special provisions and exceptions –

---

- .5 Cells and batteries when installed in equipment shall be protected from damage and short circuit, and the equipment shall be equipped with an effective means of preventing accidental activation. This requirement does not apply to devices which are intentionally active in transport (radio frequency identification (RFID) transmitters, watches, sensors, etc.) and which are not capable of generating a dangerous evolution of heat. When batteries are installed in equipment, the equipment shall be packed in strong outer packagings constructed of suitable material of adequate strength and design in relation to the packaging's capacity and its intended use unless the battery is afforded equivalent protection by the equipment in which it is contained.
- .6 Except for packages containing button cell batteries installed in equipment (including circuit boards), or no more than four cells installed in equipment or no more than two batteries installed in equipment, each package shall be marked with the following:
  - (i) an indication that the package contains "lithium metal" or "lithium ion" cells or batteries, as appropriate;
  - (ii) an indication that the package shall be handled with care and that a flammability hazard exists if the package is damaged;
  - (iii) an indication that special procedures shall be followed in the event the package is damaged, to include inspection and repacking if necessary; and
  - (iv) a telephone number for additional information.
- .7 Each consignment of one or more packages marked in accordance with paragraph .6 shall be accompanied with a document including the following:
  - (i) an indication that the package contains "lithium metal" or "lithium ion" cells or batteries, as appropriate;
  - (ii) an indication that the package shall be handled with care and that a flammability hazard exists if the package is damaged;
  - (iii) an indication that special procedures shall be followed in the event the package is damaged, to include inspection and repacking if necessary; and
  - (iv) a telephone number for additional information.
- .8 Except when batteries are installed in equipment, each package shall be capable of withstanding a 1.2 m drop test in any orientation without damage to cells or batteries contained therein, without shifting of the contents so as to allow battery to battery (or cell to cell) contact and without release of contents; and
- .9 Except when batteries are installed in or packed with equipment, packages shall not exceed 30 kg gross mass.

As used above and elsewhere in this Code, "lithium content" means the mass of lithium in the anode of a lithium metal or lithium alloy cell.

Separate entries exist for lithium metal batteries and lithium ion batteries to facilitate the transport of these batteries for specific modes of transport and to enable the application of different emergency response actions.

- 190 Aerosol dispensers shall be provided with protection against inadvertent discharge. Aerosols with a capacity not exceeding 50 ml containing only non-toxic constituents are not subject to the provisions of this Code.
- 191 Receptacles with a capacity not exceeding 50 ml containing only non-toxic constituents are not subject to the provisions of this Code.
- 193 This entry may only be used for uniform ammonium nitrate based fertilizer mixtures of the nitrogen, phosphate or potash type, containing not more than 70% ammonium nitrate and not more than 0.4% total combustible/organic material calculated as carbon or with not more than 45% ammonium nitrate and unrestricted combustible material. Fertilizers within these composition limits are not subject to the provisions of this Code when shown by a Trough Test (see United Nations *Manual of Tests and Criteria*, Part III, sub-section 38.2) that they are not liable to self-sustaining decomposition.
- 194 The control and emergency temperatures, if any, and the generic entry number for each of the currently assigned self-reactive substances are given in 2.4.2.3.2.3.
- 195 For certain organic peroxides types B or C, a smaller packaging than that allowed by packing methods OP5 or OP6 respectively has to be used (see 4.1.7 and 2.5.3.2.4).
- 196 Formulations which, in laboratory testing, neither detonate in the cavitated state nor deflagrate, which show no effect when heated under confinement and which exhibit no explosive power may be transported under this entry. The formulation must also be thermally stable (i.e., the SADT is 60°C or higher for a 50 kg package). Formulations not meeting these criteria shall be transported under the provisions of class 5.2 (see 2.5.3.2.4).

Chapter 3.3 – Special provisions applicable to certain substances, materials or articles

- 198 Nitrocellulose solutions containing not more than 20% nitrocellulose may be transported as paint, perfumery products or printing ink, as applicable. See UN Nos. 1210, 1263, 1266, 3066, 3469 and 3470.
- 199 Lead compounds which, when mixed in a ratio of 1:1000 with 0.07M hydrochloric acid and stirred for one hour at a temperature of  $23^{\circ}\text{C} \pm 2^{\circ}\text{C}$ , exhibit a solubility of 5% or less (see ISO 3711:1990 “Lead chromate pigments and lead chromate-molybdate pigments – Specifications and methods of test”) are considered insoluble and are not subject to the provisions of this Code unless they meet the criteria for inclusion in another hazard class.
- 201 Lighters and lighter refills shall comply with the provisions of the country in which they were filled. They shall be provided with protection against inadvertent discharge. The liquid portion of the gas shall not exceed 85% of the capacity of the receptacle at  $15^{\circ}\text{C}$ . The receptacles, including the closures, shall be capable of withstanding an internal pressure of twice the pressure of the liquefied petroleum gas at  $55^{\circ}\text{C}$ . The valve mechanisms and ignition devices shall be securely sealed, taped or otherwise fastened or designed to prevent operation or leakage of the contents during transport. Lighters shall not contain more than 10 g of liquefied petroleum gas. Lighter refills shall not contain more than 65 g of liquefied petroleum gas.
- 203 This entry shall not be used for polychlorinated biphenyls, UN 2315.
- 204 Articles containing smoke-producing substance(s) corrosive according to the criteria for class 8 shall be labelled with a “CORROSIVE” subsidiary risk label (Model No. 8, see 5.2.2.2.2).
- 205 This entry shall not be used for PENTACHLOROPHENOL, UN 3155.
- 207 Polymeric beads and moulding compounds may be made from polystyrene, poly(methyl methacrylate) or other polymeric material.
- 208 The commercial grade of calcium nitrate fertilizer, when consisting mainly of a double salt (calcium nitrate and ammonium nitrate) containing not more than 10% ammonium nitrate and at least 12% water of crystallization, is not subject to the provisions of this Code.
- 209 The gas shall be at a pressure corresponding to ambient atmospheric pressure at the time the containment system is closed and this shall not exceed 105 kPa absolute.
- 210 Toxins from plant, animal or bacterial sources which contain infectious substances, or toxins that are contained in infectious substances, shall be classified under class 6.2.
- 215 This entry only applies to the technically pure substance or to formulations derived from it, having an SADT higher than  $75^{\circ}\text{C}$ , and, therefore, does not apply to formulations which are self-reactive substances (for self-reactive substances, see 2.4.2.3.2.3). Homogeneous mixtures containing not more than 35% by mass of azodicarbonamide and at least 65% of inert substance are not subject to this Code unless criteria of other classes are met.
- 216 Mixtures of solids which are not subject to the provisions of this Code and flammable liquids may be transported under this entry without first applying the classification criteria of class 4.1, provided there is no free liquid visible at the time the substance is loaded or at the time the packaging or cargo transport unit is closed. Each cargo transport unit shall be leakproof when used as a bulk container. Sealed packets and articles containing less than 10 ml of a packing group II or III flammable liquid absorbed into a solid material are not subject to the provisions of this Code provided there is no free liquid in the packet or article.
- 217 This entry shall only be used for mixtures of solids which are not subject to the provisions of this Code and toxic liquids may be transported under this entry without first applying the classification criteria of class 6.1, provided there is no free liquid visible at the time the substance is loaded or at the time the packaging or cargo transport unit is closed. Each cargo transport unit shall be leakproof when used as a bulk container. This entry shall not be used for solids containing a packing group I liquid.
- 218 This entry shall only be used for mixtures of solids which are not subject to the provisions of this Code and corrosive liquids may be transported under this entry without first applying the classification criteria of class 8, provided there is no free liquid visible at the time the substance is loaded or at the time the packaging or cargo transport unit is closed. Each cargo transport unit shall be leakproof when used as a bulk container. This entry shall not be used for solids containing a packing group I liquid.
- 219 Genetically modified microorganisms (GMMOs) and genetically modified organisms (GMOs) packed and marked in accordance with packing instruction P904 are not subject to any other provisions of this Code.
- If GMMOs or GMOs meet the definition in chapter 2.6 of a toxic substance or an infectious substance and the criteria for inclusion in class 6.1 or 6.2, the provisions of this Code for transporting toxic substances or infectious substances applies.

Dangerous Goods List, special provisions and exceptions –

---

- 220 The technical name of the flammable liquid component only of this solution or mixture shall be shown in parentheses immediately following the Proper Shipping Name.
- 221 Substances included under this entry shall not be of packing group I.
- 223 If the chemical or physical properties of a substance covered by this description are such that, when tested, it does not meet the established defining criteria for the class or division listed in column 3, or any other class or division, it is not subject to the provisions of this Code except in the case of a marine pollutant where 2.10.3 applies.
- 224 Unless it can be demonstrated by testing that the sensitivity of the substance in its frozen state is no greater than in its liquid state, the substance shall remain liquid during normal transport conditions. It shall not freeze at temperatures above  $-15^{\circ}\text{C}$ .
- 225 Fire extinguishers under this entry may include installed actuating cartridges (cartridges, power device of division 1.4C or 1.4S) without changing the classification of class 2.2 provided the total quantity of deflagrating (propellant) explosives does not exceed 3.2 g per extinguishing unit.
- 226 Formulations of these substances containing not less than 30% non-volatile, non-flammable phlegmatizer are not subject to the provisions of this Code.
- 227 When phlegmatized with water and inorganic inert material, the content of urea nitrate may not exceed 75% by mass and the mixture shall not be capable of being detonated by the Series 1, type (a) test in the United Nations *Manual of Tests and Criteria*, Part I.
- 228 Mixtures not meeting the criteria for flammable gases (class 2.1) shall be transported under UN 3163.
- 230 Lithium cells and batteries may be transported under this entry if they meet the provisions of 2.9.4.
- 232 This entry shall only be used when the substance does not meet the criteria of any other class. Transport in cargo transport units other than in tanks shall be in accordance with standards specified by the competent authority of the country of origin.
- 235 This entry applies to articles which contain class 1 explosive substances and which may also contain dangerous goods of other classes. These articles are used as life-saving vehicle air-bag inflators or air-bag modules or seat-belt pretensioners.
- 236 Polyester resin kits consist of two components: a base material (class 3, packing group II or III) and an activator (organic peroxide). The organic peroxide shall be type D, E or F, not requiring temperature control. Packing group shall be II or III, according to the criteria for class 3, applied to the base material. The quantity limit and the excepted quantity code shown in columns 7a and 7b of the Dangerous Goods List apply to the base material.
- 237 The membrane filters, including paper separators, coating or backing materials, etc., that are present in transport, shall not be liable to propagate a detonation as tested by one of the tests described in the United Nations *Manual of Tests and Criteria*, Part I, Test series 1(a).
- In addition, the competent authority may determine, on the basis of the results of suitable burning rate tests taking account of the standard tests in the United Nations *Manual of Tests and Criteria*, Part III, 33.2.1, that nitrocellulose membrane filters in the form in which they are to be transported are not subject to the provisions of this Code applicable to flammable solids in class 4.1.
- 238 .1 Batteries can be considered as non-spillable provided that they are capable of withstanding the vibration and pressure differential tests given below, without leakage of battery fluid:
- Vibration test:** The battery is rigidly clamped to the platform of a vibration machine and a simple harmonic motion having an amplitude of 0.8 mm (1.6 mm maximum total excursion) is applied. The frequency is varied at the rate of 1 Hz/min between the limits of 10 Hz and 55 Hz. The entire range of frequencies and return is traversed in  $95 \pm 5$  minutes for each mounting position (direction of vibration) of the battery. The battery is tested in three mutually perpendicular positions (to include testing with fill openings and vents, if any, in an inverted position) for equal time periods.
- Pressure differential test:** Following the vibration test, the battery is stored for six hours at  $24^{\circ}\text{C} \pm 4^{\circ}\text{C}$  while subjected to a pressure differential of at least 88 kPa. The battery is tested in three mutually perpendicular positions (to include testing with fill openings and vents, if any, in an inverted position) for at least six hours in each position.
- Non-spillable type batteries which are an integral part of and necessary for the operation of mechanical or electronic equipment shall be securely fastened in the battery holder on the equipment and protected in such a manner as to prevent damage and short circuits.
- .2 Non-spillable batteries are not subject to the provisions of this Code if, at a temperature of  $55^{\circ}\text{C}$ , the electrolyte will not flow from a ruptured or cracked case and there is no free liquid to flow and if, when packaged for transport, the terminals are protected from short circuit.

Chapter 3.3 – Special provisions applicable to certain substances, materials or articles

- 239 Batteries or cells shall not contain dangerous goods other than sodium, sulphur or sodium compounds (e.g., sodium polysulphides and sodium tetrachloroaluminate). Batteries or cells shall not be offered for transport at a temperature such that liquid elemental sodium is present in the battery or cell, unless approved and under the conditions established by the competent authority.
- Cells shall consist of hermetically sealed metal casings which fully enclose the dangerous goods and which are so constructed and closed as to prevent the release of the dangerous goods under normal conditions of transport.
- Batteries shall consist of cells secured within and fully enclosed by a metal casing so constructed and closed as to prevent the release of the dangerous goods under normal conditions of transport.
- Batteries installed in vehicles are not subject to the provisions of this Code.
- 240 This entry only applies to vehicles powered by wet batteries, sodium batteries, lithium metal batteries or lithium ion batteries and equipment powered by wet batteries or sodium batteries transported with these batteries installed.
- For the purpose of this special provision, vehicles are self-propelled apparatus designed to carry one or more persons or goods. Examples of such vehicles are electrically-powered cars, motorcycles, scooters, three- and four-wheeled vehicles or motorcycles, e bikes, wheel-chairs, lawn tractors, boats and aircraft.
- Examples of equipment are lawnmowers, cleaning machines or model boats and model aircraft. Equipment powered by lithium metal batteries or lithium ion batteries shall be consigned under the entries UN 3091 LITHIUM METAL BATTERIES CONTAINED IN EQUIPMENT or UN 3091 LITHIUM METAL BATTERIES PACKED WITH EQUIPMENT or UN 3481 LITHIUM ION BATTERIES CONTAINED IN EQUIPMENT or UN 3481 LITHIUM ION BATTERIES PACKED WITH EQUIPMENT, as appropriate.
- Hybrid electric vehicles powered by both an internal combustion engine and wet batteries, sodium batteries, lithium metal batteries or lithium ion batteries, transported with the battery(ies) installed shall be consigned under the entries UN 3166 VEHICLE, FLAMMABLE GAS POWERED or UN 3166 VEHICLE, FLAMMABLE LIQUID POWERED, as appropriate. Vehicles which contain a fuel cell shall be consigned under the entries UN 3166 VEHICLE, FUEL CELL, FLAMMABLE GAS POWERED or UN 3166 VEHICLE, FUEL CELL, FLAMMABLE LIQUID POWERED, as appropriate.
- 241 The formulation shall be prepared so that it remains homogeneous and does not separate during transport. Formulations with low nitrocellulose contents and not showing dangerous properties when tested for their liability to detonate, deflagrate or explode when heated under defined confinement by tests of Test series 1(a), 2(b) and 2(c) respectively in the United Nations *Manual of Tests and Criteria*, Part I and not being a flammable solid when tested in accordance with test No. 1 in the United Nations *Manual of Tests and Criteria*, Part III, paragraph 33.2.1.4 (chips, if necessary, crushed and sieved to a particle size of less than 1.25 mm) are not subject to the provisions of this Code.
- 242 Sulphur is not subject to the provisions of this Code when it has been formed to a specific shape (such as prills, granules, pellets, pastilles or flakes).
- 243 Gasoline, motor spirit and petrol for use in spark-ignition engines (e.g., in automobiles, stationary engines and other engines) shall be assigned to this entry regardless of variations in volatility.
- 244 This entry includes materials and substances such as aluminium dross, aluminium skimmings, spent cathodes, spent potliner and aluminium salt slags.
- 247 Alcoholic beverages containing more than 24% alcohol but not more than 70% by volume, when transported as part of the manufacturing process, may be transported in wooden barrels with a capacity of more than 250 litres and not more than 500 litres meeting the general requirements of 4.1.1, as appropriate, on the following conditions:
- .1 the wooden barrels shall be checked and tightened before filling;
  - .2 sufficient ullage (not less than 3%) shall be left to allow for the expansion of the liquid;
  - .3 the wooden barrels shall be transported with the bungholes pointing upwards;
  - .4 the wooden barrels shall be transported in containers meeting the provisions of the International Convention for Safe Containers (CSC 1972), as amended, and each wooden barrel shall be secured in custom-made cradles and be wedged by appropriate means to prevent it from being displaced in any way during transport; and
  - .5 when carried on board ships, the containers shall be stowed in open cargo spaces or in enclosed cargo spaces complying with the requirements for class 3 flammable liquids with a flashpoint of 23°C c.c. or less in regulation II-2/19 of SOLAS, 74, as amended or regulation II-2/54 of SOLAS 74, as amended by the resolutions indicated in II-2/1.2.1, as applicable.
- 249 Ferrocium, stabilized against corrosion, with a minimum iron content of 10% is not subject to the provisions of this Code.

Dangerous Goods List, special provisions and exceptions –

---

- 250 This entry may only be used for samples of chemicals taken for analysis in connection with the implementation of the Convention on the Prohibition of the Development, Production, Stockpiling and Use of Chemical Weapons and on their Destruction. The transport of substances under this entry shall be in accordance with the chain of custody and security procedures specified by the Organization for the Prohibition of Chemical Weapons.
- The chemical sample may only be transported provided prior approval has been granted by the competent authority or the Director General of the Organization for the Prohibition of Chemical Weapons and providing the sample complies with the following conditions:
- .1 it shall be packaged according to packing instruction 623 in the International Civil Aviation Organization's Technical Instructions for the Safe Transport of Dangerous Goods by Air; and
  - .2 during transport, it shall be accompanied by a copy of the document of approval for transport, showing the quantity limitations and the packing provisions.
- 251 The entry CHEMICAL KIT or FIRST AID KIT is intended to apply to boxes, cases, etc., containing small quantities of various dangerous goods which are used, for example, for medical, analytical, testing or repair purposes. Such kits may not contain dangerous goods for which the quantity "0" has been indicated in column 7a of the Dangerous Goods List.
- Components shall not react dangerously (see 4.1.1.6). The total quantity of dangerous goods in any one kit shall not exceed either 1 ℓ or 1 kg. The packing group assigned to the kit as a whole shall be the most stringent packing group assigned to any individual substance in the kit.
- Kits which are carried on board vehicles for first-aid or operating purposes are not subject to the provisions of this Code.
- Chemical kits and first aid kits containing dangerous goods in inner packagings which do not exceed the quantity limits for limited quantities applicable to individual substances as specified in column 7a of the Dangerous Goods List may be transported in accordance with chapter 3.4.
- 252 Provided the ammonium nitrate remains in solution under all conditions of transport, aqueous solutions of ammonium nitrate, with not more than 0.2% combustible material, in a concentration not exceeding 80%, are not subject to the provisions of this Code.
- 266 This substance, when containing less alcohol, water or phlegmatizer than specified, shall not be transported, unless specifically authorized by the competent authority.
- 267 Any explosives, blasting, type C containing chlorates shall be segregated from explosives containing ammonium nitrate or other ammonium salts.
- 270 Aqueous solutions of class 5.1 inorganic solid nitrate substances are considered as not meeting the criteria of class 5.1 if the concentration of the substances in solution at the minimum temperature encountered in transport is not greater than 80% of the saturation limit.
- 271 Lactose or glucose or similar materials may be used as a phlegmatizer provided that the substance contains not less than 90%, by mass, of phlegmatizer. The competent authority may authorize these mixtures to be classified under class 4.1 on the basis of series 6(c) tests of Part I of the United Nations *Manual of Tests and Criteria* on at least three packages as prepared for transport. Mixtures containing at least 98%, by mass, of phlegmatizer are not subject to the provisions of this Code. Packages containing mixtures with not less than 90%, by mass, of phlegmatizer need not bear a "TOXIC" subsidiary risk label.
- 272 This substance shall not be transported under the provisions of class 4.1 unless specifically authorized by the competent authority (see UN 0143 or UN 0150 as appropriate).
- 273 Maneb and maneb preparations stabilized against self-heating need not be classified in class 4.2 when it can be demonstrated by testing that a cubic volume of 1 m<sup>3</sup> of substance does not self-ignite and that the temperature at the centre of the sample does not exceed 200°C when the sample is maintained at a temperature of not less than 75°C ± 2°C for a period of 24 hours.
- 274 For the purposes of documentation and package marking, the Proper Shipping Name shall be supplemented with the technical name (see 3.1.2.8.1).
- 277 For aerosols or receptacles containing toxic substances, the limited quantity value is 120 mℓ. For all other aerosols or receptacles, the limited quantity value is 1000 mℓ.
- 278 These substances shall not be classified and transported unless authorized by the competent authority on the basis of results from series 2 tests and series 6(c) tests of Part I of the United Nations *Manual of Tests and Criteria* on packages as prepared for transport (see 2.1.3.1). The competent authority shall assign the packing group on the basis of the chapter 2.3 criteria and the package type used for the series 6(c) tests.
- 279 The substance is assigned to this classification or packing group based on human experience rather than the strict application of classification criteria set out in this Code.



Chapter 3.3 – Special provisions applicable to certain substances, materials or articles

- 280 This entry applies to articles which are used as life-saving vehicle air bag inflators, or air bag modules or seat-belt pretensioners and which contain dangerous goods of class 1 or dangerous goods of other classes and when transported as component parts and when these articles as presented for transport have been tested in accordance with Test series 6(c) of Part I of the United Nations *Manual of Tests and Criteria*, with no explosion of the device, no fragmentation of device casing or pressure receptacle, and no projection hazard nor thermal effect which would significantly hinder fire-fighting or other emergency response efforts in the immediate vicinity.
- 281 Transport of hay, straw or bhusa when wet, damp or contaminated with oil is prohibited and when not wet or contaminated with oil is subject to the provisions of this Code.
- 283 Articles, containing gas, intended to function as shock absorbers, including impact-energy-absorbing devices or pneumatic springs, are not subject to the provisions of this Code provided:
- .1 each article has a gas space capacity not exceeding 1.6 ℓ and a charge pressure not exceeding 280 bar where the product of the capacity (litres) and charge pressure (bar) does not exceed 80 (i.e., 0.5 ℓ gas space and 160 bar charge pressure, 1 ℓ gas space and 80 bar charge pressure, 1.6 ℓ gas space and 50 bar charge pressure, 0.28 ℓ gas space and 280 bar charge pressure);
  - .2 each article has a minimum burst pressure of 4 times the charge pressure at 20°C for products not exceeding 0.5 ℓ gas space capacity and 5 times charge pressure for products greater than 0.5 ℓ gas space capacity;
  - .3 each article is manufactured from material which will not fragment upon rupture;
  - .4 each article is manufactured in accordance with a quality-assurance standard acceptable to the competent authority; and
  - .5 the design type has been subjected to a fire test demonstrating that pressure in the article is relieved by means of a fire-degradable seal or other pressure relief device, such that the article will not fragment and that the article does not rocket.
- 284 An oxygen generator, chemical, containing oxidizing substances shall meet the following conditions:
- .1 the generator, when containing an explosive device, shall only be transported under this entry when excluded from class 1 in accordance with 2.1.3 of this Code;
  - .2 the generator, without its packaging, shall be capable of withstanding a 1.8 m drop test onto a rigid, non-resilient, flat and horizontal surface, in the position most likely to cause damage, without loss of its contents and without actuation; and
  - .3 when the generator is equipped with an actuating device, it shall have at least two positive means of preventing unintentional actuation.
- 286 Nitrocellulose membrane filters covered by this entry, each with a mass not exceeding 0.5 g, are not subject to the provisions of this Code when contained individually in an article or a sealed packet.
- 288 These substances shall not be classified and transported unless authorized by the competent authority on the basis of results from series 2 tests and series 6(c) tests of Part I of the United Nations *Manual of Tests and Criteria* on packages as prepared for transport (see 2.1.3).
- 289 Air bag inflators, air bag modules or seat-belt pretensioners installed in vehicles, vessels or aircrafts or in completed components such as steering columns, door panels, seats, etc. are not subject to the provisions of this Code.
- 290 When this radioactive material meets the definitions and criteria of other classes or divisions as defined in part 2, it shall be classified in accordance with the following:
- .1 Where the substance meets the criteria for dangerous goods in excepted quantities as set out in chapter 3.5, the packagings shall be in accordance with 3.5.2 and meet the testing requirements of 3.5.3. All other requirements applicable to radioactive material, excepted packages as set out in 1.5.1.5 shall apply without reference to the other class or division;
  - .2 Where the quantity exceeds the limits specified in 3.5.1.2, the substance shall be classified in accordance with the predominant subsidiary risk. The dangerous goods transport document shall describe the substance with the UN Number and Proper Shipping Name applicable to the other class supplemented with the name applicable to the radioactive excepted package according to column 2 in the Dangerous Goods List of chapter 3.2, and the substance shall be transported in accordance with the provisions applicable to that UN Number. An example of the information shown on the dangerous goods transport document is:  
UN 1993, Flammable liquid, N.O.S. (ethanol and toluene mixture), Radioactive material, excepted package – limited quantity of material, class 3, PG II.  
In addition, the provisions of 2.7.2.4.1 shall apply;
  - .3 The provisions of chapter 3.4 for the transport of dangerous goods packed in limited quantities shall not apply to substances classified in accordance with subparagraph .2;

Dangerous Goods List, special provisions and exceptions –

- .4 When the substance meets a special provision that exempts this substance from all dangerous goods provisions of the other classes, it shall be classified in accordance with the applicable UN Number of class 7 and all requirements specified in 1.5.1.5 shall apply.
- 291 Flammable liquefied gases shall be contained within refrigerating-machine components. These components shall be designed and tested to at least three times the working pressure of the machinery. The refrigerating machines and refrigerating machinery components shall be designed and constructed to contain the liquefied gas and preclude the risk of bursting or cracking of the pressure-retaining components during normal conditions of transport. Refrigerating machines and refrigerating-machine components are not subject to the provisions of this Code if they contain less than 12 kg of gas.
- 293 The following definitions apply to matches:
- (a) *Fusee matches* are matches the heads of which are prepared with a friction-sensitive igniter composition and a pyrotechnic composition which burns with little or no flame, but with intense heat;
  - (b) *Safety matches* are combined with or attached to the box, book or card that can be ignited by friction only on a prepared surface;
  - (c) *“Strike anywhere” matches* are matches that can be ignited by friction on a solid surface;
  - (d) *Wax ‘Vesta’ matches* are matches that can be ignited by friction either on a prepared surface or on a solid surface.
- 294 Safety matches and wax ‘Vesta’ matches in an outer packaging not exceeding 25 kg net mass are not subject to any other provision (except marking) of this Code when packaged in accordance with packing instruction P407.
- 295 Batteries need not be individually marked and labelled if the pallet bears the appropriate mark and label.
- 296 These entries apply to life-saving appliances such as liferafts, personal flotation devices and self-inflating slides. UN 2990 applies to self-inflating appliances. UN 3072 applies to life-saving appliances that are not self-inflating. Life-saving appliances may contain:
- .1 signal devices (class 1) which may include smoke and illumination signal flares packed in packagings that prevent them from being inadvertently activated;
  - .2 for UN 2990 only, cartridges, power device of division 1.4, compatibility group S, may be contained for purposes of the self-inflating mechanism and provided that the quantity of explosives per appliance does not exceed 3.2 g;
  - .3 class 2.2 compressed or liquefied gases;
  - .4 electric storage batteries (class 8) and lithium batteries (class 9);
  - .5 first aid kits or repair kits containing small quantities of dangerous goods (e.g., classes 3, 4.1, 5.2, 8 or 9 substances); or
  - .6 “Strike anywhere” matches packed in packagings that prevent them from being inadvertently activated.
- Life-saving appliances packed in strong rigid outer packagings with a total maximum gross mass of 40 kg, containing no dangerous goods other than Class 2.2 compressed or liquefied gases with no subsidiary risk in receptacles with a capacity not exceeding 120 mL, installed solely for the purpose of the activation of the appliance, are not subject to the provision of this Code.
- 299 Consignments of:
- (i) Cotton, dry having a density not less than 360 kg/m<sup>3</sup>;
  - (ii) Flax, dry having a density not less than 400 kg/m<sup>3</sup>;
  - (iii) Sisal, dry having a density not less than 360 kg/m<sup>3</sup>; and
  - (iv) Tampico fibre, dry having a density not less than 360 kg/m<sup>3</sup>,
- according to ISO 8115:1986, are not subject to the provisions of this Code when transported in closed cargo transport units.
- 300 Fish meal, fish scrap and krill meal shall not be transported if the temperature at the time of loading exceeds 35°C or 5°C above the ambient temperature, whichever is higher.
- 301 This entry only applies to machinery or apparatus containing dangerous substances as a residue or an integral element of the machinery or apparatus. It shall not be used for machinery or apparatus for which a Proper Shipping Name already exists in the Dangerous Goods List. Machinery and apparatus transported under this entry shall only contain dangerous goods which are authorized to be transported in accordance with the provisions in chapter 3.4 (Limited quantities). The quantity of dangerous goods in machinery or apparatus shall not exceed the quantity specified in column 7a of the Dangerous Goods List for each item of dangerous goods contained. If the machinery or apparatus contains more than one item of dangerous goods, the individual substances shall not be capable

**Chapter 3.3 – Special provisions applicable to certain substances, materials or articles**

- of reacting dangerously with one another (see 4.1.1.6). When it is required to ensure liquid dangerous goods remain in their intended orientation, package orientation labels meeting the specifications of ISO 780: 1985 shall be affixed on at least two opposite vertical sides with the arrows pointing in the correct direction. The transport of dangerous goods in machinery or apparatus where the quantity of dangerous goods exceeds the quantity specified in column 7a of the Dangerous Goods List is authorized when approved by the competent authority, except where special provision 363 applies.
- 302 Fumigated cargo transport units containing no other dangerous goods are only subject to the provisions of 5.5.2.
- 303 Receptacles shall be assigned to the class and, if any, subsidiary hazard of the gas or mixture of gases contained therein determined in accordance with the provisions of chapter 2.2.
- 304 This entry may only be used for the transport of non-activated batteries which contain dry potassium hydroxide and which are intended to be activated prior to use by the addition of an appropriate amount of water to the individual cells.
- 305 These substances are not subject to the provisions of this Code when in concentrations of not more than 50 mg/kg.
- 306 This entry may only be used for substances that do not exhibit explosive properties of class 1 when tested in accordance to Test Series 1 and 2 of class 1 (see United Nations *Manual of Tests and Criteria*, Part I).
- 307 This entry shall be used for uniform mixtures containing ammonium nitrate as the main ingredient within the following composition limits:
- .1 not less than 90% ammonium nitrate with not more than 0.2% total combustible/organic material calculated as carbon and with added matter, if any, which is inorganic and inert towards ammonium nitrate; or
  - .2 less than 90% but more than 70% ammonium nitrate with other inorganic materials or more than 80% but less than 90% ammonium nitrate mixed with calcium carbonate and/or dolomite and/or mineral calcium sulphate and not more than 0.4% total combustible/organic material calculated as carbon; or
  - .3 nitrogen type ammonium nitrate based fertilizers containing mixtures of ammonium nitrate and ammonium sulphate with more than 45% but less than 70% ammonium nitrate and not more than 0.4% total combustible/organic material calculated as carbon such that the sum of the percentage compositions of ammonium nitrate and ammonium sulphate exceeds 70%.
- 308 Fish scrap or fish meal shall contain at least 100 ppm of antioxidant (ethoxyquin) at the time of consignment.
- 309 This entry applies to non-sensitized emulsions, suspensions and gels consisting primarily of a mixture of ammonium nitrate and fuel, intended to produce a Type E blasting explosive only after further processing prior to use.
- The mixture for emulsions typically has the following composition: 60–85% ammonium nitrate, 5–30% water, 2–8% fuel, 0.5–4% emulsifier agent, 0–10% soluble flame suppressants, and trace additives. Other inorganic nitrate salts may replace part of the ammonium nitrate.
- The mixture for suspensions and gels typically has the following composition: 60–85% ammonium nitrate, 0–5% sodium or potassium perchlorate, 0–17% hexamine nitrate or monomethylamine nitrate, 5–30% water, 2–15% fuel, 0.5–4% thickening agent, 0–10% soluble flame suppressants, and trace additives. Other inorganic nitrate salts may replace part of the ammonium nitrate.
- Substances shall satisfactorily pass Test Series 8 of the United Nations *Manual of Tests and Criteria*, Part I, section 18 and be approved by the competent authority.
- 310 The testing requirements in chapter 38.3 of the United Nations *Manual of Tests and Criteria* do not apply to production runs consisting of not more than 100 cells and batteries, or to pre-production prototypes of cells and batteries when these prototypes are transported for testing, if:
- .1 the cells and batteries are transported in an outer packaging that is a metal, plastics or plywood drum or a metal, plastics or wooden box and that meets the criteria for packing group I packagings; and
  - .2 each cell and battery is individually packed in an inner packaging inside an outer packaging and is surrounded by cushioning material that is non-combustible, and non-conductive.
- 311 Substances shall not be transported under this entry unless approved by the competent authority on the basis of the results of appropriate tests according to Part I of the United Nations *Manual of Tests and Criteria*. Packaging shall ensure that the percentage of diluent does not fall below that stated in the competent authority approval at any time during transport.
- 312 Vehicles or machinery powered by a fuel cell engine shall be consigned under the entries UN 3166 VEHICLE, FUEL CELL, FLAMMABLE GAS POWERED or UN 3166 VEHICLE, FUEL CELL, FLAMMABLE LIQUID POWERED, or UN 3166 ENGINE, FUEL CELL, FLAMMABLE GAS POWERED or UN 3166

Dangerous Goods List, special provisions and exceptions –

---

ENGINE, FUEL CELL, FLAMMABLE LIQUID POWERED as appropriate. These entries include hybrid electric vehicles powered by both a fuel cell and an internal combustion engine with wet batteries, sodium batteries, lithium metal batteries or lithium ion batteries, transported with the battery(ies) installed.

Other vehicles which contain an internal combustion engine shall be consigned under the entries UN 3166 VEHICLE, FLAMMABLE GAS POWERED or UN 3166 VEHICLE, FLAMMABLE LIQUID POWERED, as appropriate. These entries include hybrid electric vehicles powered by both an internal combustion engine and wet batteries, sodium batteries, lithium metal batteries or lithium ion batteries, transported with the batteries installed.

- 314 (a) These substances are liable to exothermic decomposition at elevated temperatures. Decomposition can be initiated by heat or by impurities (e.g., powdered metals (iron, manganese, cobalt, magnesium) and their compounds).
- (b) During the course of transport, these substances shall be shaded from direct sunlight and all sources of heat and be placed in adequately ventilated areas.
- 315 This entry shall not be used for class 6.1 substances which meet the inhalation toxicity criteria for packing group I described in 2.6.2.2.4.3.
- 316 This entry applies only to calcium hypochlorite, dry, when transported in non-friable tablet form.
- 317 "Fissile – excepted" applies only to those packages complying with 6.4.11.2.
- 318 For the purposes of documentation, the Proper Shipping Name shall be supplemented with the technical name (see 3.1.2.8). Technical names need not be shown on the package. When the infectious substances to be transported are unknown, but suspected of meeting the criteria for inclusion in category A and assignment to UN 2814 or UN 2900, the words "suspected category A infectious substance" shall be shown, in parentheses, following the Proper Shipping Name on the transport document, but not on the outer packagings.
- 319 Substances packed and packages marked in accordance with packing instruction P650 are not subject to any other provisions of this Code.
- 321 These storage systems shall always be considered as containing hydrogen.
- 322 When transported in non-friable tablet form, these goods are assigned to packing group III.
- 324 This substance needs to be stabilized when in concentrations of not more than 99%.
- 325 In the case of non-fissile or fissile excepted uranium hexafluoride, the material shall be classified under UN 2978.
- 326 In the case of fissile uranium hexafluoride, the material shall be classified under UN 2977.
- 327 Waste aerosols consigned in accordance with 5.4.1.4.3.3 may be transported under this entry for the purposes of reprocessing or disposal. They need not be protected against inadvertent discharge provided that measures to prevent dangerous build-up of pressure and dangerous atmospheres are addressed. Waste aerosols, other than those leaking or severely deformed, shall be packed in accordance with packing instruction P207 and special provision PP87, or packing instruction LP02 and special packing provision L2. Leaking or severely deformed aerosols shall be transported in salvage packagings provided appropriate measures are taken to ensure there is no dangerous build-up of pressure. Waste aerosols shall not be transported in closed freight containers.
- 328 This entry applies to fuel cell cartridges, including when contained in equipment or packed with equipment. Fuel cell cartridges installed in or integral to a fuel cell system are regarded as contained in equipment. "Fuel cell cartridge" means an article that stores fuel for discharge into the fuel cell through a valve(s) that controls the discharge of fuel into the fuel cell. Fuel cell cartridges, including when contained in equipment, shall be designed and constructed to prevent fuel leakage under normal conditions of transport.

Fuel cell cartridge design types using liquids as fuels shall pass an internal pressure test at a pressure of 100 kPa (gauge) without leakage.

Except for fuel cell cartridges containing hydrogen in metal hydride, which shall be in compliance with special provision 339, each fuel cell cartridge design type shall be shown to pass a 1.2 m drop test onto an unyielding surface, in the orientation most likely to result in failure of the containment system, with no loss of contents.

When lithium metal or lithium ion batteries are contained in the fuel cell system, the consignment shall be consigned under this entry and under the appropriate entries for UN 3091 LITHIUM METAL BATTERIES CONTAINED IN EQUIPMENT or UN 3481 LITHIUM ION BATTERIES CONTAINED IN EQUIPMENT.

**Chapter 3.3 – Special provisions applicable to certain substances, materials or articles**

- 332 Magnesium nitrate hexahydrate is not subject to the provisions of this Code.
- 333 Ethanol and gasoline, motor spirit or petrol mixtures for use in spark-ignition engines (e.g., in automobiles, stationary engines and other engines) shall be assigned to this entry regardless of variations in volatility.
- 334 A fuel cell cartridge may contain an activator provided it is fitted with two independent means of preventing unintended mixing with the fuel during transport.
- 335 Mixtures of solids which are not subject to the provisions of this Code and environmentally hazardous liquids assigned to UN 3082 may be classified and transported as UN 3077, provided there is no free liquid visible at the time the substance is loaded or at the time the packaging or cargo transport unit is closed. If free liquid is visible at the time the mixture is loaded or at the time the packaging or cargo transport unit is closed, the mixture shall be classified as UN 3082. Each cargo transport unit shall be leakproof when used as a bulk container. Sealed packets and articles containing less than 10 ml of an environmentally hazardous liquid assigned to UN 3082, absorbed into a solid material but with no free liquid in the packet or article, or containing less than 10 g of an environmentally hazardous solid assigned to UN 3077, are not subject to the provisions of this Code.
- 338 Each fuel cell cartridge transported under this entry and designed to contain a liquefied flammable gas shall:
- .1 be capable of withstanding, without leakage or bursting, a pressure of at least two times the equilibrium pressure of the contents at 55°C;
  - .2 Not contain more than 200 ml liquefied flammable gas, the vapour pressure of which shall not exceed 1 000 kPa at 55 °C; and
  - .3 pass the hot water bath test prescribed in 6.2.4.1 of chapter 6.2.
- 339 Fuel cell cartridges containing hydrogen in a metal hydride transported under this entry shall have a water capacity less than or equal to 120 ml. The pressure in the fuel cell cartridge shall not exceed 5 MPa at 55°C. The design type shall withstand, without leaking or bursting, a pressure of two (2) times the design pressure of the cartridge at 55°C or 200 kPa more than the design pressure of the cartridge at 55°C, whichever is greater. The pressure at which this test is conducted is referred to in the Drop Test and the Hydrogen Cycling Test as the “minimum shell burst pressure”.
- Fuel cell cartridges shall be filled in accordance with procedures provided by the manufacturer. The manufacturer shall provide the following information with each fuel cell cartridge:
- .1 Inspection procedures to be carried out before initial filling and before refilling of the fuel cell cartridge;
  - .2 Safety precautions and potential hazards to be aware of;
  - .3 Method for determining when the rated capacity has been achieved;
  - .4 Minimum and maximum pressure range;
  - .5 Minimum and maximum temperature range; and
  - .6 Any other requirements to be met for initial filling and refilling, including the type of equipment to be used for initial filling and refilling.
- The fuel cell cartridges shall be designed and constructed to prevent fuel leakage under normal conditions of transport. Each cartridge design type, including cartridges integral to a fuel cell, shall be subjected to and shall pass the following tests:

**Drop test**

A 1.8 m drop test onto an unyielding surface in four different orientations:

- .1 Vertically, on the end containing the shut-off valve assembly;
- .2 Vertically, on the end opposite to the shut-off valve assembly;
- .3 Horizontally, onto a steel apex with a diameter of 38 mm, with the steel apex in the upward position; and
- .4 At a 45° angle on the end containing the shut-off valve assembly.

There shall be no leakage, determined by using a soap bubble solution or other equivalent means on all possible leak locations, when the cartridge is charged to its rated charging pressure. The fuel cell cartridge shall then be hydrostatically pressurized to destruction. The recorded burst pressure shall exceed 85% of the minimum shell burst pressure.

**Fire test**

A fuel cell cartridge filled to rated capacity with hydrogen shall be subjected to a fire engulfment test. The cartridge design, which may include a vent feature integral to it, is deemed to have passed the fire test if:

- .1 The internal pressure vents to zero gauge pressure without rupture of the cartridge; or
- .2 The cartridge withstands the fire for a minimum of 20 minutes without rupture.

#### Hydrogen cycling test

This test is intended to ensure that a fuel cell cartridge design stress limits are not exceeded during use.

The fuel cell cartridge shall be cycled from not more than 5% rated hydrogen capacity to not less than 95% rated hydrogen capacity and back to not more than 5% rated hydrogen capacity. The rated charging pressure shall be used for charging and temperatures shall be held within the operating temperature range. The cycling shall be continued for at least 100 cycles.

Following the cycling test, the fuel cell cartridge shall be charged and the water volume displaced by the cartridge shall be measured. The cartridge design is deemed to have passed the hydrogen cycling test if the water volume displaced by the cycled cartridge does not exceed the water volume displaced by an uncycled cartridge charged to 95% rated capacity and pressurized to 75% of its minimum shell burst pressure.

#### Production leak test

Each fuel cell cartridge shall be tested for leaks at  $15^{\circ}\text{C} \pm 5^{\circ}\text{C}$ , while pressurized to its rated charging pressure. There shall be no leakage, determined by using a soap bubble solution or other equivalent means on all possible leak locations.

Each fuel cell cartridge shall be permanently marked with the following information:

- .1 The rated charging pressure in megapascals (MPa);
- .2 The manufacturer's serial number of the fuel cell cartridges or unique identification number; and
- .3 The date of expiry based on the maximum service life (year in four digits; month in two digits).

340 Chemical kits, first aid kits and polyester resin kits containing dangerous substances in inner packagings which do not exceed the quantity limits for excepted quantities applicable to individual substances as specified in column 7b of the Dangerous Goods List may be transported in accordance with chapter 3.5. Class 5.2 substances, although not individually authorized as excepted quantities in the Dangerous Goods List, are authorized in such kits and are assigned code E2 (see 3.5.1.2).

341 Bulk transport of infectious substances in BK2 bulk containers is only permitted for infectious substances contained in animal material as defined in 1.2.1 (see 4.3.2.4.1).

342 Glass inner receptacles (such as ampoules or capsules) intended only for use in sterilization devices, when containing less than 30 ml of ethylene oxide per inner packaging with not more than 300 ml per outer packaging, may be transported in accordance with the provisions in chapter 3.5, irrespective of the indication of "E0" in column 7b of the Dangerous Goods List provided that:

- .1 After filling, each glass inner receptacle has been determined to be leak tight by placing the glass inner receptacle in a hot water bath at a temperature, and for a period of time, sufficient to ensure that an internal pressure equal to the vapour pressure of ethylene oxide at  $55^{\circ}\text{C}$  is achieved. Any glass inner receptacle showing evidence of leakage, distortion or other defect under this test shall not be transported under the terms of this special provision;
- .2 In addition to the packaging required by 3.5.2, each glass inner receptacle is placed in a sealed plastics bag compatible with ethylene oxide and capable of containing the contents in the event of breakage or leakage of the glass inner receptacle; and
- .3 Each glass inner receptacle is protected by a means of preventing puncture of the plastics bag (e.g., sleeves or cushioning) in the event of damage to the packaging (e.g., by crushing).

343 This entry applies to crude oil containing hydrogen sulphide in sufficient concentration that vapours evolved from the crude oil can present an inhalation hazard. The packing group assigned shall be determined by the flammability hazard and inhalation hazard, in accordance with the degree of danger presented.

344 The provisions of 6.2.4 shall be met.

345 This gas contained in open cryogenic receptacles with a maximum capacity of 1 litre constructed with glass double walls having the space between the inner and outer wall evacuated (vacuum insulated) is not subject to the provisions of this Code provided each receptacle is transported in an outer packaging with suitable cushioning or absorbent materials to protect it from impact damage.

346 Open cryogenic receptacles conforming to the requirements of packing instruction P203 and containing no dangerous goods except for UN 1977, nitrogen, refrigerated liquid, which is fully absorbed in a porous material, are not subject to any other provisions of this Code.

347 This entry shall only be used if the results of Test series 6 (d) of part 1 of the United Nations *Manual of Tests and Criteria* have demonstrated that any hazardous effects arising from functioning are confined within the package.

348 Batteries manufactured after 31 December 2011 shall be marked with the Watt hour rating on the outside case.

Chapter 3.3 – Special provisions applicable to certain substances, materials or articles

- 349 Mixtures of a hypochlorite with an ammonium salt are not to be accepted for transport. UN 1791 hypochlorite solution is a substance of class 8.
- 350 Ammonium bromate and its aqueous solutions and mixtures of a bromate with an ammonium salt are not to be accepted for transport.
- 351 Ammonium chlorate and its aqueous solutions and mixtures of a chlorate with an ammonium salt are not to be accepted for transport.
- 352 Ammonium chlorite and its aqueous solutions and mixtures of a chlorite with an ammonium salt are not to be accepted for transport.
- 353 Ammonium permanganate and its aqueous solutions and mixtures of a permanganate with an ammonium salt are not to be accepted for transport.
- 354 This substance is toxic by inhalation.
- 355 Oxygen cylinders for emergency use transported under this entry may include installed actuating cartridges (cartridges, power device of class 1.4, compatibility group C or S), without changing the classification of class 2.2 provided the total quantity of deflagrating (propellant) explosives does not exceed 3.2 g per oxygen cylinder. The cylinders with the installed actuating cartridges as prepared for transport shall have an effective means of preventing inadvertent activation.
- 356 Metal hydride storage systems installed in vehicles, vessels or aircrafts or in completed components or intended to be installed in vehicles, vessels or aircrafts shall be approved by the competent authority before acceptance for transport. The transport document shall include an indication that the package was approved by the competent authority or a copy of the competent authority approval shall accompany each consignment.
- 357 Petroleum crude oil containing hydrogen sulphide in sufficient concentration that vapours evolved from the crude oil can present an inhalation hazard shall be consigned under the entry UN 3494 PETROLEUM SOUR CRUDE OIL, FLAMMABLE, TOXIC.
- 358 Nitroglycerin solution in alcohol with more than 1% but not more than 5% nitroglycerin may be classified in Class 3 and assigned to UN 3064 provided all the requirements of packing instruction P300 are complied with.
- 359 Nitroglycerin solution in alcohol with more than 1% but not more than 5% nitroglycerin shall be classified in Class 1 and assigned to UN 0144 if not all the requirements of packing instruction P300 are complied with.
- 360 Vehicles only powered by lithium metal batteries or lithium ion batteries shall be consigned under the entry UN 3171 BATTERY POWERED VEHICLE.
- 361 This entry applies to electric double layer capacitors with an energy storage capacity greater than 0.3 Wh. Capacitors with an energy storage capacity of 0.3 Wh or less are not subject to the provisions of this Code. Energy storage capacity means the energy held by a capacitor, as calculated using the nominal voltage and capacitance. All capacitors to which this entry applies, including capacitors containing an electrolyte that does not meet the classification criteria of any class or division of dangerous goods, shall meet the following conditions:
- .1 Capacitors not installed in equipment shall be transported in an uncharged state. Capacitors installed in equipment shall be transported either in an uncharged state or protected against short circuit;
  - .2 Each capacitor shall be protected against a potential short circuit hazard in transport as follows:
    - (i) When a capacitor's energy storage capacity is less than or equal to 10 Wh or when the energy storage capacity of each capacitor in a module is less than or equal to 10 Wh, the capacitor or module shall be protected against short circuit or be fitted with a metal strap connecting the terminals; and
    - (ii) When the energy storage capacity of a capacitor or a capacitor in a module is more than 10 Wh, the capacitor or module shall be fitted with a metal strap connecting the terminals;
  - .3 Capacitors containing dangerous goods shall be designed to withstand a 95 kPa pressure differential;
  - .4 Capacitors shall be designed and constructed to safely relieve pressure that may build up in use, through a vent or a weak point in the capacitor casing. Any liquid which is released upon venting shall be contained by the packaging or by the equipment in which a capacitor is installed; and
  - .5 Capacitors shall be marked with the energy storage capacity in Wh
- Capacitors containing an electrolyte not meeting the classification criteria of any class or division of dangerous goods, including when installed in equipment, are not subject to other provisions of this Code.

Dangerous Goods List, special provisions and exceptions –

---

Capacitors containing an electrolyte meeting the classification criteria of any class or division of dangerous goods, with an energy storage capacity of 10 Wh or less are not subject to other provisions of this Code when they are capable of withstanding a 1.2 metre drop test unpackaged on an unyielding surface without loss of contents.

Capacitors containing an electrolyte meeting the classification criteria of any class or division of dangerous goods that are not installed in equipment and with an energy storage capacity of more than 10 Wh are subject to the provisions of this Code.

Capacitors installed in the equipment and containing an electrolyte meeting the classification criteria of any class or division of dangerous goods, are not subject to other provisions of this Code provided the equipment is packaged in a strong outer packaging constructed of suitable material and of adequate strength and design, in relation to the packaging's intended use and in such a manner as to prevent accidental functioning of capacitors during transport. Large robust equipment containing capacitors may be offered for transport unpackaged or on pallets when capacitors are afforded equivalent protection by the equipment in which they are contained.

**Note:** Capacitors which by design maintain a terminal voltage (e.g., asymmetrical capacitors) do not belong to this entry.

362 This entry applies to liquids, pastes or powders, pressurized with a propellant which meets the definition of a gas in 2.2.1.1 and 2.2.1.2 (1) or (2).

**Note:** A chemical under pressure in an aerosol dispenser shall be transported under UN 1950.

The following provisions shall apply:

- 1 The chemical under pressure shall be classified based on the hazard characteristics of the components in the different states:
  - the propellant;
  - the liquid; or
  - the solid.

If one of these components, which can be a pure substance or a mixture, needs to be classified as flammable, the chemical under pressure shall be classified as flammable in class 2.1. Flammable components are flammable liquids and liquid mixtures, flammable solids and solid mixtures or flammable gases and gas mixtures meeting the following criteria:

- (i) A flammable liquid is a liquid having a flashpoint of not more than 93°C;
- (ii) A flammable solid is a solid which meets the criteria in 2.4.2.2 of this Code;
- (iii) A flammable gas is a gas which meets the criteria in 2.2.2.1 of this Code;

- 2 Gases of class 2.3 and gases with a subsidiary risk of 5.1 shall not be used as a propellant in a chemical under pressure;
- 3 Where the liquid or solid components are classified as dangerous goods of class 6.1, packing groups II or III, or class 8, packing groups II or III, the chemical under pressure shall be assigned a subsidiary risk of class 6.1 or class 8 and the appropriate UN number shall be assigned. Components classified in class 6.1, packing group I, or class 8, packing group I, shall not be used for transport under this proper shipping name;
- 4 In addition, chemicals under pressure with components meeting the properties of: class 1, explosives; class 3, liquid desensitized explosives; class 4.1, self-reactive substances and solid desensitized explosives; class 4.2, substances liable to spontaneous combustion; class 4.3, substances which, in contact with water, emit flammable gases; class 5.1 oxidizing substances; class 5.2, organic peroxides; class 6.2, Infectious substances or class 7, Radioactive material, shall not be used for transport under this proper shipping name;
- 5 Substances to which PP86 or TP7 are assigned in Column 9 and Column 14 of the Dangerous Goods List in Chapter 3.2 and therefore require air to be eliminated from the vapour space, shall not be used for transport under this UN number but shall be transported under their respective UN numbers as listed in the Dangerous Goods List of Chapter 3.2.

363 This entry also applies to dangerous goods above the quantity specified in Column 7a of the Dangerous Goods List of Chapter 3.2 in means of containment (other than vehicles or means of containment defined in Part 6 of these Code subject to special provision 301) integral to equipment or machinery (e.g. generators, compressors, heating units, etc) as part of their original design type. They are not subject to any other provisions of this Code if the following provisions are met:

- 1 the means of containment shall be in compliance with the construction requirements of the competent authority;
- 2 any valves or openings (e.g. venting devices) in the means of containment containing dangerous goods shall be closed during transport;



Chapter 3.3 – Special provisions applicable to certain substances, materials or articles

- .3 the machinery or equipment shall be loaded in an orientation to prevent inadvertent leakage of dangerous goods and secured by means capable of restraining the machinery or equipment to prevent any movement during transport which would change the orientation or cause it to be damaged;
- .4 where the means of containment has a capacity of not more than 450 l, the labelling requirements of 5.2.2 and, when necessary, the marking requirements of 5.2.1.6 shall apply and, where the capacity is greater than 450 l but not more than 1 500 l, the machinery or equipment shall be labelled on all four external sides in accordance with 5.2.2 and, when necessary, shall be marked in accordance with 5.2.1.6 ;
- .5 where the means of containment has a capacity greater than 1500 l, the machinery or equipment shall be placarded on all four external sides in accordance with 5.3.1.1.2 and, when necessary, shall be marked in accordance with 5.2.1.6 ;
- .6 the provisions of Part 2, Part 3 except columns (8) to (14) of the dangerous goods list in 3.2, 5.1.1 except 5.1.1.4, 5.3 except 5.3.2.0 and 5.3.2.1, 5.4 and Part 7 shall apply.
- .7 the transport of machinery or equipment where the quantity of substance exceeds 1500 l is authorized when approved by the competent authority.
- 364 This article may only be transported under the provisions of Chapter 3.4 if, as presented for transport, the package is capable of passing the test in accordance with Test Series 6(d) of Part I of the Manual of Tests and Criteria as determined by the competent authority.
- 365 For manufactured instruments and articles containing mercury, see UN 3506.
- 366 Manufactured instruments and articles containing not more than 1 kg of mercury are not subject to the provisions of this Code.
- 900 The transport of the following substances is prohibited:  
 AMMONIUM HYPOCHLORITE  
 AMMONIUM NITRATE liable to self-heating sufficient to initiate decomposition  
 AMMONIUM NITRITES and mixtures of an inorganic nitrite with an ammonium salt  
 CHLORIC ACID, AQUEOUS SOLUTION with more than 10% chloric acid  
 ETHYL NITRITE pure  
 HYDROCYANIC ACID, AQUEOUS SOLUTION (HYDROGEN CYANIDE, AQUEOUS SOLUTION)  
 with more than 20% hydrogen cyanide  
 HYDROGEN CHLORIDE, REFRIGERATED LIQUID  
 HYDROGEN CYANIDE SOLUTION, IN ALCOHOL with more than 45% hydrogen cyanide  
 MERCURY OXYCYANIDE pure  
 METHYL NITRITE  
 PERCHLORIC ACID with more than 72% acid, by mass  
 SILVER PICRATE, dry or wetted with less than 30% water by mass  
 ZINC AMMONIUM NITRITE
- See also special provisions 349, 350, 351, 352 and 353.
- 903 HYPOCHLORITE MIXTURES with 10% or less available CHLORINE are not subject to the provisions of this Code.
- 904 The provisions of this Code, except for the marine pollution aspects, do not apply to these substances if they are completely miscible with water, except when transported in receptacles with a capacity greater than 250 l and in tanks.
- 905 May only be shipped as an 80% solution in TOLUENE. The pure product is shock-sensitive and decomposes with explosive violence and the possibility of detonation when heated under confinement. Can be ignited by impact.
- 907 The consignment shall be accompanied by a certificate from a recognized authority stating:
- moisture content;
  - fat content;
  - details of anti-oxidant treatment for meals older than 6 months (for UN 2216 only);
  - anti-oxidant concentration at the time of shipment, which must exceed 100 mg/kg (for UN 2216 only);
  - packing, number of bags and total mass of the consignment;
  - temperature of fishmeal at the time of despatch from the factory;
  - date of production.
- No weathering/curing is required prior to loading. Fishmeal under UN 1374 shall have been weathered for not less than 28 days before shipment.

Dangerous Goods List, special provisions and exceptions –

---

- When fishmeal is packed into containers, the containers shall be packed in such a way that the free air space has been restricted to the minimum.
- 912 This entry also covers solutions in water with concentrations above 70%.
- 915 This entry shall not be used for wetted explosives, self-reactive substances or metal powders.
- 916 The provisions of this Code do not apply to this substance when:
- mechanically produced, with a particle size of 53 microns or greater; or
  - chemically produced, with a particle size of 840 microns or greater.
- 917 Scrap with rubber content below 45% or exceeding 840 microns and fully vulcanized hard rubber are not subject to the provisions of this Code.
- 919 UREA NITRATE, WETTED with not less than 10% water, by mass, may be transported under the provisions of this class, provided it is packaged in accordance with packing instruction P002.
- 920 Bars, ingots or sticks are not subject to the provisions of this Code.
- 921 Zirconium, dry, 254 microns or thicker is not subject to the provisions of this Code.
- 922 LEAD PHOSPHITE, DIBASIC which is accompanied by the certificate from the shipper stating that the substance, as offered for shipment, has been stabilized in such a way that it does not possess the properties of class 4.1 is not subject to the provisions of this Code.
- 923 The temperature shall be checked regularly.
- 925 The provisions of this Code do not apply to:
- non-activated carbon blacks of mineral origin;
  - a consignment of carbon if it passes the tests for self-heating substances as reflected in the United Nations *Manual of Tests and Criteria* (see 33.3.1.3.3), and is accompanied by a certificate from a laboratory accredited by the competent authority, stating that the product to be loaded has been correctly sampled by trained staff from that laboratory and that the sample was correctly tested and has passed the test; and
  - carbons made by a steam activation process.
- 926 This substance shall preferably have been weathered for not less than one month before shipment unless a certificate from a person recognized by the competent authority of the country of shipment states a maximum moisture content of 5%.
- 927 *p*-Nitrosodimethylaniline, wetted with more than 50% water is not subject to the provisions of this Code.
- 928 The provisions of this Code shall not apply to:
- fishmeal when acidified and wetted with more than 40% water, by mass, irrespective of other factors;
  - consignments of fishmeal which are accompanied by a certificate issued by a recognized competent authority of the country of shipment or other recognized authority stating that the product has no self-heating properties when transported in packaged form; or
  - fishmeal manufactured from “white” fish with a moisture content of not more than 12% and a fat content of not more than 5% by mass.
- 929 If satisfied, as a result of tests, that such relaxation is justified, the competent authority may permit:
- the seed cakes described as “SEED CAKE, containing vegetable oil (a) mechanically expelled seeds, containing more than 10% of oil or more than 20% of oil and moisture combined” to be transported under conditions governing “SEED CAKE, containing vegetable oil (b) solvent extractions and expelled seeds, containing not more than 10% of oil and, when the amount of moisture is higher than 10% not more than 20% of oil and moisture combined”, and
  - the seed cakes described as “SEED CAKE, containing vegetable oil (b) solvent extractions and expelled seeds, containing not more than 10% of oil and, when the amount of moisture is higher than 10% not more than 20% of oil and moisture combined” to be transported under conditions governing SEED CAKE, UN 2217.
- Certificates from the shipper shall state oil content and moisture content and shall accompany the shipment.
- 930 All pesticides can only be carried under the provisions of this class if accompanied by a certificate supplied by the shipper stating that, when in contact with water, it is not combustible and does not show tendency to autoignition, and that the mixture of gases evolved is not flammable. Otherwise, the provisions of class 4.3 shall be applicable.
- 931 A consignment of this substance which is accompanied by a declaration from the shipper stating that it has no self-heating properties is not subject to the provisions of this Code.
- 932 Requires a certificate from the maker or shipper, stating that the shipment was stored under cover, but in the open air, in the size in which it was packaged, for not less than 3 days prior to shipment.

Chapter 3.3 – Special provisions applicable to certain substances, materials or articles

- 934 Requires the percentage range of calcium carbide impurity to be shown on the shipping documents.
- 935 Substances which do not evolve flammable gases when wet, which are accompanied by a certificate from the shipper stating that the substance, as offered for shipment, does not evolve flammable gases when wet, are not subject to the provisions of this Code.
- 937 The solid hydrated form of this substance is not subject to the provisions of this Code.
- 939 A consignment of this substance that is accompanied by a shipper's certificate stating that it does not contain more than 0.05% maleic anhydride is not subject to the provisions of this Code.
- 942 The concentration and temperature of the solution at the time of loading, its percentage of combustible material and of chlorides as well as the contents of free acid shall be certified.
- 943 Water-activated articles shall bear a subsidiary risk of class 4.3.
- 945 Stabilization of fishmeal shall be achieved to prevent spontaneous combustion by effective application of between 400 and 1000 mg/kg (ppm) ethoxyquin, or liquid BHT (butylated hydroxytoluene) or between 1000 and 4000 mg/kg (ppm) BHT in powder form at the time of production. The said application shall occur no longer than twelve months prior to shipment.
- 946 Requires certification from the shipper that the substance is not of class 4.2.
- 948 These substances may be transported in bulk in cargo transport units only if their melting point is 75°C or above.
- 951 Bulk container shall be hermetically sealed and under a nitrogen blanket.
- 952 UN 1942 may be transported in bulk container if approved by the competent authority.
- 954 The provisions of this Code shall not apply to consignments of compressed baled hay with a moisture content of less than 14% shipped in closed cargo transport units and accompanied by a certificate from the shipper stating that the product does not present any class 4.1, UN 1327, hazard in transport and that its moisture content is less than 14%.
- 955 If a viscous substance and its packaging fulfils the provisions of 2.3.2.5, the packing provisions of chapter 4.1, the marking and labelling provisions of chapter 5.2 and the package testing provisions of chapter 6.1 are not applicable.
- 957 Lithium cells and batteries manufactured before 1 January 2003 that have not been tested in accordance with the requirements in chapter 38.3 of the United Nations *Manual of Tests and Criteria*, as well as articles which contain such lithium cells or batteries, may be transported until 31 December 2013 if all applicable provisions of this Code are met.
- 958 This entry covers articles, such as rags, cotton waste, clothing or sawdust, containing polychlorinated biphenyls, polyhalogenated biphenyls or polyhalogenated terphenyls where no free visible liquid is present.
- 959 Waste aerosols authorized for transport under special provision 327 shall only be transported on short international voyages. Long international voyages are authorized only with the approval of the competent authority. Packagings shall be marked and labelled and cargo transport units shall be marked and placarded for appropriate sub-division of class 2 and, if applicable, the subsidiary risk(s).
- 960 Not subject to the provisions of this Code but may be subject to provisions governing the transport of dangerous goods by other modes.
- 961 Vehicles and equipment are not subject to the provisions of this Code if they are stowed on a roll-on/roll-off ship or in another cargo space designated by the Administration (flag State) as specifically designed and approved for the carriage of vehicles and equipment and there are no signs of leakage from the battery, engine, fuel cell, compressed gas cylinder or accumulator, or fuel tank when applicable.
- In addition, vehicles and equipment are not subject to the provisions of this Code if any of the following conditions are met:
- .1 The fuel tank(s) of the vehicle or equipment powered by a flammable liquid fuel is empty and installed batteries are protected from short circuit;
  - .2 The fuel tank(s) of the vehicle or equipment powered by a flammable gas is emptied of liquefied or compressed gas, the positive pressure in the tank does not exceed 2 bar, the fuel shut-off or isolation valve is closed and secured, and installed batteries are protected from short circuit; or
  - .3 The vehicle or equipment is solely powered by a wet or dry electric storage battery or a sodium battery, and the battery is protected from short circuit.
- 962 Vehicles or equipment powered by internal combustion engines, fuel cells or batteries not meeting the conditions of special provision 961 shall be assigned to class 9 and shall meet the following requirements:
- .1 vehicles and equipment shall not show signs of leakage from batteries, engines, fuel cells, compressed gas cylinders or accumulators, or fuel tank(s) when applicable;

Dangerous Goods List, special provisions and exceptions –

---

- .2 for flammable liquid powered vehicles and equipment, the fuel tank(s) containing the flammable liquid shall not be more than one fourth full and in any case the flammable liquid shall not exceed 250 l;
  - .3 for flammable gas powered vehicles and equipment, the fuel shut-off valve of the fuel tank(s) shall be securely closed;
  - .4 installed batteries shall be protected from damage, short circuit, and accidental activation during transport. Lithium ion or lithium metal batteries shall meet the requirements of the United Nations *Manual of Tests and Criteria*, part III, subsection 38.3, unless otherwise approved by the competent authority; and
  - .5 dangerous goods required for the operation of the vehicle or equipment such as fire extinguishers, compressed gas accumulators, airbag inflators, etc., shall be securely mounted in the vehicle or equipment.  
The marking, labelling and placarding provisions of this Code shall not apply.
- 963 Nickel-metal hydride button cells or nickel-metal hydride cells or batteries packed with or contained in equipment are not subject to the provisions of this Code.  
All other nickel-metal hydride cells or batteries shall be securely packed and protected from short circuit. They are not subject to other provisions of this Code provided that they are loaded in a cargo transport unit in a total quantity of less than 100 kg gross mass. When loaded in a cargo transport unit in a total quantity of 100 kg gross mass or more, they are not subject to other provisions of this Code except those of 5.4.1, 5.4.3 and column (16) of the Dangerous Goods List in chapter 3.2.
- 964 This substance is not subject to the provisions of this Code when transported in non-friable prills or granules form and if it passes the test for oxidizing solid substances as reflected in the United Nations *Manual of Tests and Criteria* (see 34.4.1) and is accompanied by a certificate from a laboratory accredited by a competent authority, stating that the product has been correctly sampled by trained staff from the laboratory and that the sample was correctly tested and has passed the test.
- 965
- .1 When transported in cargo transport units, the cargo transport units shall provide an adequate exchange of air in the unit (e.g., by using a ventilated container, open-top container or container in one door off operation) to prevent the build-up of an explosive atmosphere. Alternatively, these entries shall be transported under temperature control in refrigerated cargo transport units that comply with the provisions of 7.3.7.6. When cargo transport units with venting devices are used, these devices shall be kept clear and operable. When mechanical devices are used for ventilation, they shall be explosion-proof to prevent ignition of flammable vapours from the substances.
  - .2 The provisions of .1 do not apply if:
    - a) the substance is packed in hermetically sealed packagings or IBCs, which conform to packing group II performance level for liquid dangerous goods according to the provisions of 6.1 or 6.5, respectively; and
    - b) the marked hydraulic test pressure exceeds 1.5 times the total gauge pressure in the packagings or IBCs determined at 55°C for the respective filling goods according to 4.1.1.10.1.
  - .3 Where the substance is loaded in closed cargo transport units, the provisions of 7.3.6.1 shall be met.
  - .4 Cargo transport units shall be marked with a warning mark including the words “CAUTION – MAY CONTAIN FLAMMABLE VAPOUR” with lettering not less than 25 mm high. This mark shall be affixed at each access point in a location where it will be easily seen by persons prior to opening or entering the cargo transport unit and shall remain on the cargo transport unit until the following provisions are met:
    - a) the cargo transport unit has been completely ventilated to remove any hazardous concentration of vapour or gas;
    - b) the immediate vicinity of the cargo transport unit is clear of any source of ignition; and
    - c) the goods have been unloaded.
- 966 Sheeted bulk containers (BK1) are only permitted in accordance with 4.3.3.
- 967 Flexible bulk containers (BK3) are only permitted in accordance with 4.3.4.

## Chapter 3.4

### *Dangerous goods packed in limited quantities*

#### **3.4.1 General**

**3.4.1.1** This Chapter provides the provisions applicable to the transport of dangerous goods of certain classes packed in limited quantities. The applicable quantity limit for the inner packaging or article is specified for each substance in Column 7a of the Dangerous Goods List of Chapter 3.2. In addition, the quantity "0" has been indicated in this column for each entry not permitted to be transported in accordance with this Chapter.

**3.4.1.2** Limited quantities of dangerous goods packed in such limited quantities, meeting the provisions of this Chapter, are not subject to any other provisions of this Code except the relevant provisions of:

- .1 Part 1, Chapters 1.1, 1.2 and 1.3;
- .2 Part 2;
- .3 Part 3, Chapters 3.1, 3.2, 3.3;
- .4 Part 4, 4.1.1.1, 4.1.1.2 and 4.1.1.4 to 4.1.1.8;
- .5 Part 5, 5.1.1 except 5.1.1.4, 5.1.2.3, 5.2.1.7, 5.2.1.9, 5.3.2.3, 5.3.2.4, and chapter 5.4;
- .6 Part 6, construction requirements of 6.1.4, 6.2.1.2 and 6.2.4;
- .7 Part 7, 7.1.3.2, 7.6.3.1 and 7.3 except 7.3.3.15 and 7.3.4.1.

#### **3.4.2 Packing**

**3.4.2.1** Dangerous goods shall be packed only in inner packagings placed in suitable outer packagings. Intermediate packagings may be used. In addition, for articles of Division 1.4, Compatibility Group S, the provisions of section 4.1.5 shall be fully complied with. The use of inner packagings is not necessary for the transport of articles such as aerosols or "receptacles, small, containing gas". The total gross mass of the package shall not exceed 30 kg.

**3.4.2.2** Except for articles of Division 1.4, Compatibility Group S, shrink-wrapped or stretch-wrapped trays meeting the conditions of 4.1.1.1, 4.1.1.2 and 4.1.1.4 to 4.1.1.8 are acceptable as outer packagings for articles or inner packagings containing dangerous goods transported in accordance with this Chapter. Inner packagings that are liable to break or be easily punctured, such as those made of glass, porcelain, stoneware or certain plastics, shall be placed in suitable intermediate packagings meeting the provisions of 4.1.1.1, 4.1.1.2 and 4.1.1.4 to 4.1.1.8, and be so designed that they meet the construction requirements of 6.1.4. The total gross mass of the package shall not exceed 20 kg.

**3.4.2.3** Liquid goods of Class 8, packing group II in glass, porcelain or stoneware inner packagings shall be enclosed in a compatible and rigid intermediate packaging.

#### **3.4.3 Stowage**

Dangerous goods packed in limited quantity are allocated stowage category A as defined in 7.1.3.2. The other stowage provisions indicated in column (16) of the Dangerous Goods List are not applicable.

#### **3.4.4 Segregation**

**3.4.4.1** Different dangerous substances in limited quantities may be packed in the same outer packaging, provided:

- .1 the substances comply with the provisions of 7.2.6.1; and
- .2 the segregation provisions of chapter 7.2, including the segregation provisions in column (16) of the Dangerous Goods List, are taken into account. However, notwithstanding the individual provisions specified in the Dangerous Goods List, substances in packing group III within the same class may be

Dangerous Goods List, special provisions and exceptions –

---

packed together subject to compliance with 3.4.4.1.1 of the IMDG Code. The following statement shall be included in the transport document: "Transport in accordance with 3.4.4.1.2 of the IMDG Code" (see 5.4.1.5.2.2).

3.4.4.2 The segregation provisions of chapter 7.2 are not applicable for packagings containing dangerous goods in limited quantities or in relation to other dangerous goods.

### 3.4.5 Marking and placarding

3.4.5.1 Except for air transport, packages containing dangerous goods in limited quantities shall bear the marking shown below:

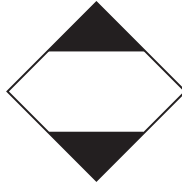

Marking for packages containing limited quantities

The marking shall be readily visible, legible and able to withstand open weather exposure without a substantial reduction in effectiveness. The top and bottom portions and the surrounding line shall be black. The centre area shall be white or a suitable contrasting background. The minimum dimensions shall be 100 mm × 100 mm and the minimum width of line forming the diamond shall be 2 mm. If the size of the package so requires, the dimension may be reduced, to be not less than 50 mm × 50 mm provided the marking remains clearly visible.

3.4.5.2 Packages containing dangerous goods consigned for air transport in conformity with the provisions of Part 3, Chapter 4 of the ICAO Technical Instructions for the Safe Transport of Dangerous Goods by Air shall bear the marking shown below:



Marking for packages containing limited quantities conforming to part 3, chapter 4 of the ICAO Technical Instructions for the Safe Transport of Dangerous Goods by Air

The marking shall be readily visible, legible and able to withstand open weather exposure without a substantial reduction in effectiveness. The top and bottom portions and the surrounding line shall be black. The centre area shall be white or a suitable contrasting background. The minimum dimensions shall be 100 mm × 100 mm. The minimum width of line forming diamond shall be 2 mm. The symbol "Y" shall be placed in the centre of the mark and shall be clearly visible. If the size of the package so requires, the dimension may be reduced, to be not less than 50 mm × 50 mm provided the marking remains clearly visible.

3.4.5.3 Packages containing dangerous goods bearing the marking shown in 3.4.5.2 shall be deemed to meet the provisions of sections 3.4.1 and 3.4.2 of this Chapter and need not bear the marking shown in 3.4.5.1.

3.4.5.4 When packages containing dangerous goods packed in limited quantities are placed in an overpack or in a unit load, the overpack or the unit load shall be marked with the marking required by this chapter unless the markings representative of all dangerous goods in the overpack or the unit load are visible. In addition, an overpack shall be marked with the word "OVERPACK" unless markings representative of all dangerous goods, as required by this chapter, in the overpack are visible. The other provisions of 5.1.2.1 apply only if other dangerous goods which are not packed in limited quantities are contained in the overpack or in a unit load and only in relation to these other dangerous goods.

**3.4.5.5 Placarding and marking of cargo transport unit**

- 3.4.5.5.1 Cargo transport unit containing dangerous goods packed in limited quantities with no other dangerous goods shall not be placarded nor marked according to 5.3.2.0 and 5.3.2.1. However, they shall be suitably marked on the exterior with the mark in 3.4.5.5.4.
- 3.4.5.5.2 Cargo transport units containing dangerous goods and dangerous goods packed in limited quantities shall be placarded and marked according to the provisions applicable to the dangerous goods which are not packed in limited quantities. However, if no placard or mark is required for the dangerous goods not packed in limited quantities, the cargo transport units shall be marked with the mark in 3.4.5.5.4.
- 3.4.5.5.3 In all cases, if the dangerous goods packed in limited quantities are marine pollutants, the cargo transport units shall bear the marine pollutant mark as indicated in 5.3.2.3.
- 3.4.5.5.4 When required in 3.4.5.5.1 or 3.4.5.5.2, the following mark shall be affixed on cargo transport units :



The marking shall be readily visible, legible and be such that this information will still be identifiable on cargo transport units surviving at least three months' immersion in the sea. In considering suitable marking methods, account shall be taken of ease with which the surface of the cargo transport unit can be marked. The top and bottom portions and the surrounding line shall be black. The centre area shall be white or a suitable contrasting background. The minimum dimensions shall be of 250 mm x 250 mm in locations indicated in 5.3.1.1.4.1.

**3.4.6 Documentation**

- 3.4.6.1 In addition to the provisions for documentation specified in chapter 5.4, the words "limited quantity" or "LTD QTY" shall be included on the dangerous goods declaration together with the description of the shipment.

## Chapter 3.5

### *Dangerous goods packed in excepted quantities*

#### 3.5.1 Excepted quantities

3.5.1.1 Excepted quantities of dangerous goods of certain classes, other than articles, meeting the provisions of this chapter, are not subject to any other provisions of this Code except for:

- .1 The training provisions in chapter 1.3;
- .2 The classification procedures and packing group criteria in Part 2, Classification;
- .3 The packaging provisions of 4.1.1.1, 4.1.1.2, 4.1.1.4, 4.1.1.4.1 and 4.1.1.6 in Part 4; and
- .4 The provisions for documentation specified in chapter 5.4.

**Note:** In the case of radioactive material, the provisions for radioactive material in excepted packages in 1.5.1.5 apply.

3.5.1.2 Dangerous goods which may be carried as excepted quantities in accordance with the provisions of this chapter are shown in column 7b of the Dangerous Goods List by means of an alphanumeric code as follows:

Code	Maximum net quantity per inner packaging (in grams for solids and mℓ for liquids and gases)	Maximum net quantity per outer packaging (in grams for solids and mℓ for liquids and gases, or sum of grams and mℓ in the case of mixed packaging)
E0	Not permitted as Excepted Quantity	
E1	30	1000
E2	30	500
E3	30	300
E4	1	500
E5	1	300

For gases, the volume indicated for inner packagings refers to the water capacity of the inner receptacle and the volume indicated for outer packagings refers to the combined water capacity of all inner packagings within a single outer packaging.

3.5.1.3 Where dangerous goods in excepted quantities for which different codes are assigned are packaged together, the total quantity per outer packaging shall be limited to that corresponding to the most restrictive code.

3.5.1.4 Excepted quantities of dangerous goods assigned to codes E1, E2, E4 and E5 are not subject to the provisions of this Code provided that:

- .1 The maximum net quantity of material per inner packaging is limited to 1 mℓ for liquids and gases and 1 g for solids;
- .2 The provisions of 3.5.2 are met, except that an intermediate packaging is not required if the inner packagings are securely packed in an outer packaging with cushioning material in such a way that, under normal conditions of transport, they cannot break, be punctured, or leak their contents; and for liquid dangerous goods, the outer packaging contains sufficient absorbent material to absorb the entire contents of the inner packagings;
- .3 The provisions of 3.5.3 are complied with; and
- .4 The maximum net quantity of dangerous goods per outer packaging does not exceed 100 g for solids or 100 mℓ for liquids and gases.



## **3.5.2 Packagings**

**3.5.2.1** Packagings used for the transport of dangerous goods in excepted quantities shall be in compliance with the following:

- .1 There shall be an inner packaging and each inner packaging shall be constructed of plastic (when used for liquid dangerous goods it shall have a thickness of not less than 0.2 mm), or of glass, porcelain, stoneware, earthenware or metal (see also 4.1.1.2) and the closure of each inner packaging shall be held securely in place with wire, tape or other positive means; any receptacle having a neck with moulded screw threads shall have a leakproof threaded-type cap. The closure shall be resistant to the contents;
- .2 Each inner packaging shall be securely packed in an intermediate packaging with cushioning material in such a way that, under normal conditions of transport, they cannot break, be punctured or leak their contents. The intermediate packaging shall completely contain the contents in case of breakage or leakage, regardless of package orientation. For liquid dangerous goods, the intermediate packaging shall contain sufficient absorbent material to absorb the entire contents of the inner packaging. In such cases, the absorbent material may be the cushioning material. Dangerous goods shall not react dangerously with cushioning, absorbent material and packaging material or reduce the integrity or function of the materials;
- .3 The intermediate packaging shall be securely packed in a strong, rigid outer packaging (wooden, fibre-board or other equally strong material);
- .4 Each package type shall be in compliance with the provisions in 3.5.3;
- .5 Each package shall be of such a size that there is adequate space to apply all necessary markings; and
- .6 Overpacks may be used and may also contain packages of dangerous goods or goods not subject to the provisions of this Code.

## **3.5.3 Tests for packages**

**3.5.3.1** The complete package as prepared for transport, with inner packagings filled to not less than 95% of their capacity for solids or 98% for liquids, shall be capable of withstanding, as demonstrated by testing which is appropriately documented, without breakage or leakage of any inner packaging and without significant reduction in effectiveness:

- .1 Drops onto a rigid, non-resilient flat and horizontal surface from a height of 1.8 m:
  - (i) Where the sample is in the shape of a box, it shall be dropped in each of the following orientations:
    - flat on the base;
    - flat on the top;
    - flat on the longest side;
    - flat on the shortest side;
    - on a corner
  - (ii) Where the sample is in the shape of a drum, it shall be dropped in each of the following orientations:
    - diagonally on the top chime, with the centre of gravity directly above the point of impact;
    - diagonally on the base chime;
    - flat on the side.

**Note:** Each of the above drops may be performed on different but identical packages.

- .2 A force applied to the top surface for a duration of 24 hours, equivalent to the total weight of identical packages if stacked to a height of 3 m (including the sample).

**3.5.3.2** For the purposes of testing, the substances to be transported in the packaging may be replaced by other substances except where this would invalidate the results of the tests. For solids, when another substance is used, it shall have the same physical characteristics (mass, grain size, etc.) as the substance to be carried. In the drop tests for liquids, when another substance is used, its relative density (specific gravity) and viscosity shall be similar to those of the substance to be transported.

## **3.5.4 Marking of packages**

**3.5.4.1** Packages containing excepted quantities of dangerous goods prepared in accordance with this chapter shall be durably and legibly marked with the mark shown below. The primary hazard class of each of the dangerous goods contained in the package shall be shown in the mark. Where the name of the consignor or consignee is not shown elsewhere on the package, this information shall be included within the mark.

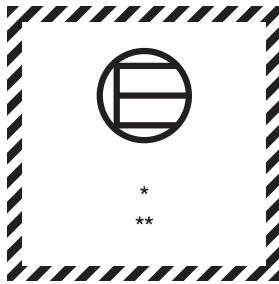

Excepted quantities mark

Hatching and symbol of the same colour, black or red,  
on white or suitable contrasting background

\* The class, or, when assigned, the division number(s), shall be shown in this location.

\*\* The name of the consignor or of the consignee shall be shown in this location if not shown elsewhere on the package.

3.5.4.2 The dimensions of the mark shall be a minimum of 100 mm × 100 mm.

3.5.4.3 An overpack containing dangerous goods in excepted quantities shall display the markings required by 3.5.4.1, unless such markings on packages within the overpack are clearly visible.

### 3.5.5 Maximum number of packages in any cargo transport unit

3.5.5.1 The number of packages containing dangerous goods packed in excepted quantities in any cargo transport unit shall not exceed 1000.

### 3.5.6 Documentation

3.5.6.1 In addition to the provisions for documentation specified in chapter 5.4, the words “dangerous goods in excepted quantities” and the number of packages shall be included on the dangerous goods declaration together with the description of the shipment.

### 3.5.7 Stowage

3.5.7.1 Dangerous goods packed in excepted quantity are allocated stowage category A as defined in 7.1.3.2. The other stowage provisions indicated in column (16) of the Dangerous Goods List are not applicable.

### 3.5.8 Segregation

3.5.8.1 The segregation provisions of chapters 7.2 to 7.7, including the segregation provisions in column (16) of the Dangerous Goods List, are not applicable for packagings containing dangerous goods packed in excepted quantities or in relation to other dangerous goods.

3.5.8.2 The segregation provisions of chapters 7.2 to 7.7, including the segregation provisions in column (16) of the Dangerous Goods List, are not applicable for different dangerous goods in excepted quantities in the same outer packaging provided that they do not react dangerously with each other (see 4.1.1.6).



# APPENDICES



## Appendix A

---

### *List of generic and N.O.S. Proper Shipping Names*

Substances or articles not mentioned specifically by name in the Dangerous Goods List in chapter 3.2 shall be classified in accordance with 3.1.1.2. Thus the name in the Dangerous Goods List which most appropriately describes the substance or article shall be used as the Proper Shipping Name. The main generic entries and all the N.O.S. entries given in the Dangerous Goods List are listed below. This Proper Shipping Name shall be supplemented by the technical name when special provision 274 or 318 has been assigned to the entry in column 6 of the Dangerous Goods List. For marine pollutants, see also 3.1.2.9.

In this list, general and N.O.S. names are grouped according to their hazard class or division. Within each hazard class or division, the names have been placed into three groups as follows:

- specific entries covering a group of substances or articles of a particular chemical or technical nature;
- pesticide entries, for class 3 and class 6.1;
- general entries covering a group of substances or articles having one or more general dangerous properties.

THE MOST SPECIFIC APPLICABLE NAME SHALL ALWAYS BE USED.

Appendices

Class or division	Subsidiary risk	UN Number	Proper Shipping Name
1		0190	<b>CLASS 1</b> SAMPLES, EXPLOSIVE, other than initiating explosive
			<b>Division 1.1</b>
1.1A		0473	SUBSTANCES, EXPLOSIVE, N.O.S.
1.1B		0461	COMPONENTS, EXPLOSIVE TRAIN, N.O.S.
1.1C		0462	ARTICLES, EXPLOSIVE, N.O.S.
1.1C		0474	SUBSTANCES, EXPLOSIVE, N.O.S.
1.1C		0497	<b>PROPELLANT, LIQUID</b>
1.1C		0498	PROPELLANT, SOLID
1.1D		0463	ARTICLES, EXPLOSIVE, N.O.S.
1.1D		0475	SUBSTANCES, EXPLOSIVE, N.O.S.
1.1E		0464	ARTICLES, EXPLOSIVE, N.O.S.
1.1F		0465	ARTICLES, EXPLOSIVE, N.O.S.
1.1G		0476	SUBSTANCES, EXPLOSIVE, N.O.S.
1.1L		0354	ARTICLES, EXPLOSIVE, N.O.S.
1.1L		0357	SUBSTANCES, EXPLOSIVE, N.O.S.
			<b>Division 1.2</b>
1.2B		0382	COMPONENTS, EXPLOSIVE TRAIN, N.O.S.
1.2C		0466	ARTICLES, EXPLOSIVE, N.O.S.
1.2D		0467	ARTICLES, EXPLOSIVE, N.O.S.
1.2E		0468	ARTICLES, EXPLOSIVE, N.O.S.
1.2F		0469	ARTICLES, EXPLOSIVE, N.O.S.
1.2K	6.1	0020	AMMUNITION, TOXIC with burster, expelling charge or propelling charge
1.2L	4.3	0248	CONTRIVANCES, WATER-ACTIVATED with burster, expelling charge or propelling charge
1.2L		0355	ARTICLES, EXPLOSIVE, N.O.S.
1.2L		0358	SUBSTANCES, EXPLOSIVE, N.O.S.
			<b>Division 1.3</b>
1.3C		0132	DEFLAGRATING METAL SALTS OF AROMATIC NITRO-DERIVATIVES, N.O.S.
1.3C		0470	ARTICLES, EXPLOSIVE, N.O.S.
1.3C		0477	SUBSTANCES, EXPLOSIVE, N.O.S.
1.3C		0495	PROPELLANT, LIQUID
1.3C		0499	PROPELLANT, SOLID
1.3G		0478	SUBSTANCES, EXPLOSIVE, N.O.S.
1.3K	6.1	0021	AMMUNITION, TOXIC with burster, expelling charge or propelling charge
1.3L	4.3	0249	CONTRIVANCES, WATER-ACTIVATED with burster, expelling charge or propelling charge
1.3L		0356	ARTICLES, EXPLOSIVE, N.O.S.
1.3L		0359	SUBSTANCES, EXPLOSIVE, N.O.S.
			<b>Division 1.4</b>
1.4B		0350	ARTICLES, EXPLOSIVE, N.O.S.
1.4B		0383	COMPONENTS, EXPLOSIVE TRAIN, N.O.S.
1.4C		0351	ARTICLES, EXPLOSIVE, N.O.S.
1.4C		0479	SUBSTANCES, EXPLOSIVE, N.O.S.
1.4C		0501	PROPELLANT, SOLID
1.4D		0352	ARTICLES, EXPLOSIVE, N.O.S.
1.4D		0480	SUBSTANCES, EXPLOSIVE, N.O.S.
1.4E		0471	ARTICLES, EXPLOSIVE, N.O.S.
1.4F		0472	ARTICLES, EXPLOSIVE, N.O.S.
1.4G		0353	ARTICLES, EXPLOSIVE, N.O.S.
1.4G		0485	SUBSTANCES, EXPLOSIVE, N.O.S.
1.4S		0349	ARTICLES, EXPLOSIVE, N.O.S.
1.4S		0384	COMPONENTS, EXPLOSIVE TRAIN, N.O.S.
1.4S		0481	SUBSTANCES, EXPLOSIVE, N.O.S.
			<b>Division 1.5</b>
1.5D		0482	SUBSTANCES, EXPLOSIVE, VERY INSENSITIVE (SUBSTANCES, EVI), N.O.S.
			<b>Division 1.6</b>
1.6N		0486	ARTICLES, EXPLOSIVE, EXTREMELY INSENSITIVE (ARTICLES, EEI)

*Appendix A – List of generic and N.O.S. Proper Shipping Names*

Class or division	Subsidiary risk	UN Number	Proper Shipping Name
<b>CLASS 2</b>			
<b>Class 2.1</b>			
<b>Specific entries</b>			
2.1		1964	HYDROCARBON GAS MIXTURE, COMPRESSED, N.O.S.
2.1		1965	HYDROCARBON GAS MIXTURE, LIQUEFIED, N.O.S.
2.1		3354	INSECTICIDE GAS, FLAMMABLE, N.O.S.
<b>General entries</b>			
2.1		1954	COMPRESSED GAS, FLAMMABLE, N.O.S.
2.1		3161	LIQUEFIED GAS, FLAMMABLE, N.O.S.
2.1		3167	GAS SAMPLE, NON-PRESSURIZED, FLAMMABLE, N.O.S., not refrigerated liquid
2.1		3312	GAS, REFRIGERATED LIQUID, FLAMMABLE, N.O.S.
2.1		3501	CHEMICAL UNDER PRESSURE, FLAMMABLE, N.O.S.
2.1	6.1	3504	CHEMICAL UNDER PRESSURE, FLAMMABLE, TOXIC, N.O.S.
2.1	8	3505	CHEMICAL UNDER PRESSURE, FLAMMABLE, CORROSIVE, N.O.S.
<b>Class 2.2</b>			
<b>Specific entries</b>			
2.2		1078	REFRIGERANT GAS, N.O.S.
2.2		1968	INSECTICIDE GAS, N.O.S.
<b>General entries</b>			
2.2		1956	COMPRESSED GAS, N.O.S.
2.2		3163	LIQUEFIED GAS, N.O.S.
2.2		3158	GAS, REFRIGERATED LIQUID, N.O.S.
2.2		3500	CHEMICAL UNDER PRESSURE, N.O.S.
2.2	5.1	3156	COMPRESSED GAS, OXIDIZING, N.O.S.
2.2	5.1	3157	LIQUEFIED GAS, OXIDIZING, N.O.S.
2.2	5.1	3311	GAS, REFRIGERATED LIQUID, OXIDIZING, N.O.S.
2.2	6.1	3502	CHEMICAL UNDER PRESSURE, TOXIC, N.O.S.
2.2	8	3503	CHEMICAL UNDER PRESSURE, CORROSIVE, N.O.S.
<b>Class 2.3</b>			
<b>Specific entries</b>			
2.3		1967	INSECTICIDE GAS, TOXIC, N.O.S.
2.3	2.1	3355	INSECTICIDE GAS, TOXIC, FLAMMABLE, N.O.S.
<b>General entries</b>			
2.3		1955	COMPRESSED GAS, TOXIC, N.O.S.
2.3		3162	LIQUEFIED GAS, TOXIC, N.O.S.
2.3		3169	GAS SAMPLE, NON-PRESSURIZED, TOXIC, N.O.S., not refrigerated liquid
2.3	2.1	1953	COMPRESSED GAS, TOXIC, FLAMMABLE, N.O.S.
2.3	2.1	3160	LIQUEFIED GAS, TOXIC, FLAMMABLE, N.O.S.
2.3	2.1	3168	GAS SAMPLE, NON-PRESSURIZED, TOXIC, FLAMMABLE, N.O.S., not refrigerated liquid
2.3	2.1 + 8	3305	COMPRESSED GAS, TOXIC, FLAMMABLE, CORROSIVE, N.O.S.
2.3	2.1 + 8	3309	LIQUEFIED GAS, TOXIC, FLAMMABLE, CORROSIVE, N.O.S.
2.3	5.1	3303	COMPRESSED GAS, TOXIC, OXIDIZING, N.O.S.
2.3	5.1	3307	LIQUEFIED GAS, TOXIC, OXIDIZING, N.O.S.
2.3	5.1 + 8	3306	COMPRESSED GAS, TOXIC, OXIDIZING, CORROSIVE, N.O.S.
2.3	5.1 + 8	3310	LIQUEFIED GAS, TOXIC, OXIDIZING, CORROSIVE, N.O.S.
2.3	8	3304	COMPRESSED GAS, TOXIC, CORROSIVE, N.O.S.
2.3	8	3308	LIQUEFIED GAS, TOXIC, CORROSIVE, N.O.S.

Appendices

Class or division	Subsidiary risk	UN Number	Proper Shipping Name
<b>CLASS 3</b>			
<b>Specific entries</b>			
3		1224	KETONES, LIQUID, N.O.S.
3		1268	PETROLEUM DISTILLATES, N.O.S. or PETROLEUM PRODUCTS, N.O.S.
3		1987	ALCOHOLS, N.O.S.
3		1989	ALDEHYDES, N.O.S.
3		2319	TERPENE HYDROCARBONS, N.O.S.
3		3271	ETHERS, N.O.S.
3		3272	ESTERS, N.O.S.
3		3295	HYDROCARBONS, LIQUID, N.O.S.
3		3336	MERCAPTANS, LIQUID, FLAMMABLE, N.O.S. or MERCAPTAN MIXTURE, LIQUID, FLAMMABLE, N.O.S.
3		3343	NITROGLYCERIN MIXTURE, DESENSITIZED, LIQUID, FLAMMABLE, N.O.S. with not more than 30% nitroglycerin, by mass
3		3357	NITROGLYCERIN MIXTURE, DESENSITIZED, LIQUID, N.O.S. with not more than 30% nitroglycerin, by mass
3		3379	DESENSITIZED EXPLOSIVE, LIQUID, N.O.S.
3	6.1	1228	MERCAPTANS, LIQUID, FLAMMABLE, TOXIC, N.O.S. or MERCAPTAN MIXTURE, LIQUID, FLAMMABLE, TOXIC, N.O.S.
3	6.1	1986	ALCOHOLS, FLAMMABLE, TOXIC, N.O.S.
3	6.1	1988	ALDEHYDES, FLAMMABLE, TOXIC, N.O.S.
3	6.1	2478	ISOCYANATES, FLAMMABLE, TOXIC, N.O.S. or ISOCYANATE SOLUTION, FLAMMABLE, TOXIC, N.O.S.
3	6.1	3248	MEDICINE, LIQUID, FLAMMABLE, TOXIC, N.O.S.
3	6.1	3273	NITRILES, FLAMMABLE, TOXIC, N.O.S.
3	8	2733	AMINES, FLAMMABLE, CORROSIVE, N.O.S. or POLYAMINES, FLAMMABLE, CORROSIVE, N.O.S.
3	8	2985	CHLOROSILANES, FLAMMABLE, CORROSIVE, N.O.S.
3	8	3274	ALCOHOLATES SOLUTION, N.O.S. in alcohol
<b>Pesticides</b>			
3	6.1	2758	CARBAMATE PESTICIDE, LIQUID, FLAMMABLE, TOXIC flashpoint <23°C
3	6.1	2760	ARSENICAL PESTICIDE, LIQUID, FLAMMABLE, TOXIC flashpoint <23°C
3	6.1	2762	ORGANOCHLORINE PESTICIDE, LIQUID, FLAMMABLE, TOXIC flashpoint <23°C
3	6.1	2764	TRIAZINE PESTICIDE, LIQUID, FLAMMABLE, TOXIC flashpoint <23°C
3	6.1	2772	THIOCARBAMATE PESTICIDE, LIQUID, FLAMMABLE, TOXIC flashpoint <23°C
3	6.1	2776	COPPER BASED PESTICIDE, LIQUID, FLAMMABLE, TOXIC flashpoint <23°C
3	6.1	2778	MERCURY BASED PESTICIDE, LIQUID, FLAMMABLE, TOXIC flashpoint <23°C
3	6.1	2780	SUBSTITUTED NITROPHENOL PESTICIDE, LIQUID, FLAMMABLE, TOXIC flashpoint <23°C
3	6.1	2782	BIPYRIDILIUM PESTICIDE, LIQUID, FLAMMABLE, TOXIC flashpoint <23°C
3	6.1	2784	ORGANOPHOSPHORUS PESTICIDE, LIQUID, FLAMMABLE, TOXIC flashpoint <23°C
3	6.1	2787	ORGANOTIN PESTICIDE, LIQUID, FLAMMABLE, TOXIC flashpoint <23°C
3	6.1	3021	PESTICIDE, LIQUID, FLAMMABLE, TOXIC, N.O.S. flashpoint <23°C
3	6.1	3024	COUMARIN DERIVATIVE PESTICIDE, LIQUID, FLAMMABLE, TOXIC flashpoint <23°C
3	6.1	3346	PHENOXYACETIC ACID DERIVATIVE PESTICIDE, LIQUID, FLAMMABLE, TOXIC flashpoint <23°C
3	6.1	3350	PYRETHROID PESTICIDE, LIQUID, FLAMMABLE, TOXIC flashpoint <23°C
<b>General entries</b>			
3		1993	FLAMMABLE LIQUID, N.O.S.
3		3256	ELEVATED TEMPERATURE LIQUID, FLAMMABLE, N.O.S. with flashpoint above 60°C, at or above its flashpoint
3	6.1	1992	FLAMMABLE LIQUID, TOXIC, N.O.S.
3	6.1 + 8	3286	FLAMMABLE LIQUID, TOXIC, CORROSIVE, N.O.S.
3	8	2924	FLAMMABLE LIQUID, CORROSIVE, N.O.S.



Appendix A – List of generic and N.O.S. Proper Shipping Names

Class or division	Subsidiary risk	UN Number	Proper Shipping Name
			<b>CLASS 4</b>
			<b>Class 4.1</b>
			<b>Specific entries</b>
4.1		1353	FIBRES or FABRICS IMPREGNATED WITH WEAKLY NITRATED NITROCELLULOSE, N.O.S.
4.1		3089	METAL POWDER, FLAMMABLE, N.O.S.
4.1		3182	METAL HYDRIDES, FLAMMABLE, N.O.S.
4.1		3221	SELF-REACTIVE LIQUID TYPE B
4.1		3222	SELF-REACTIVE SOLID TYPE B
4.1		3223	SELF-REACTIVE LIQUID TYPE C
4.1		3224	SELF-REACTIVE SOLID TYPE C
4.1		3225	SELF-REACTIVE LIQUID TYPE D
4.1		3226	SELF-REACTIVE SOLID TYPE D
4.1		3227	SELF-REACTIVE LIQUID TYPE E
4.1		3228	SELF-REACTIVE SOLID TYPE E
4.1		3229	SELF-REACTIVE LIQUID TYPE F
4.1		3230	SELF-REACTIVE SOLID TYPE F
4.1		3231	SELF-REACTIVE LIQUID TYPE B, TEMPERATURE CONTROLLED
4.1		3232	SELF-REACTIVE SOLID TYPE B, TEMPERATURE CONTROLLED
4.1		3233	SELF-REACTIVE LIQUID TYPE C, TEMPERATURE CONTROLLED
4.1		3234	SELF-REACTIVE SOLID TYPE C, TEMPERATURE CONTROLLED
4.1		3235	SELF-REACTIVE LIQUID TYPE D, TEMPERATURE CONTROLLED
4.1		3236	SELF-REACTIVE SOLID TYPE D, TEMPERATURE CONTROLLED
4.1		3237	SELF-REACTIVE LIQUID TYPE E, TEMPERATURE CONTROLLED
4.1		3238	SELF-REACTIVE SOLID TYPE E, TEMPERATURE CONTROLLED
4.1		3239	SELF-REACTIVE LIQUID TYPE F, TEMPERATURE CONTROLLED
4.1		3240	SELF-REACTIVE SOLID TYPE F, TEMPERATURE CONTROLLED
4.1		3319	NITROGLYCERIN MIXTURE, DESENSITIZED, SOLID, N.O.S. with more than 2% but not more than 10% nitroglycerin, by mass
4.1		3344	PENTAERYTHRITOL TETRANITRATE MIXTURE (PENTAERYTHRITOL TETRANITRATE; PETN), DESENSITIZED, SOLID, N.O.S. with more than 10% but not more than 20% PETN, by mass
4.1		3380	DESENSITIZED EXPLOSIVE, SOLID, N.O.S.
			<b>General entries</b>
4.1		1325	FLAMMABLE SOLID, ORGANIC, N.O.S.
4.1		3175	SOLIDS CONTAINING FLAMMABLE LIQUID, N.O.S.
4.1		3176	FLAMMABLE SOLID, ORGANIC, MOLTEN, N.O.S.
4.1		3178	FLAMMABLE SOLID, INORGANIC, N.O.S.
4.1		3181	METAL SALTS OF ORGANIC COMPOUNDS, FLAMMABLE, N.O.S.
4.1	5.1	3097	FLAMMABLE SOLID, OXIDIZING, N.O.S.
4.1	6.1	2926	FLAMMABLE SOLID, TOXIC, ORGANIC, N.O.S.
4.1	6.1	3179	FLAMMABLE SOLID, TOXIC, INORGANIC, N.O.S.
4.1	8	2925	FLAMMABLE SOLID, CORROSIVE, ORGANIC, N.O.S.
4.1	8	3180	FLAMMABLE SOLID, CORROSIVE, INORGANIC, N.O.S.
			<b>Class 4.2</b>
			<b>Specific entries</b>
4.2		1373	FIBRES or FABRICS, ANIMAL or VEGETABLE or SYNTHETIC, N.O.S. with oil
4.2		1378	METAL CATALYST, WETTED with a visible excess of liquid
4.2		1383	PYROPHORIC METAL, N.O.S. or PYROPHORIC ALLOY, N.O.S.
4.2		2006	PLASTICS, NITROCELLULOSE-BASED, SELF-HEATING, N.O.S.
4.2		2881	METAL CATALYST, DRY
4.2		3189	METAL POWDER, SELF-HEATING, N.O.S.
4.2		3205	ALKALINE EARTH METAL ALCOHOLATES, N.O.S.
4.2		3313	ORGANIC PIGMENTS, SELF-HEATING
4.2		3342	XANTHATES
4.2		3391	ORGANOMETALLIC SUBSTANCE, SOLID, PYROPHORIC
4.2		3392	ORGANOMETALLIC SUBSTANCE, LIQUID, PYROPHORIC

Appendices

Class or division	Subsidiary risk	UN Number	Proper Shipping Name
			<b>CLASS 4 (continued)</b>
			<b>Class 4.2 (continued)</b>
			<b>Specific entries (continued)</b>
4.2		3400	ORGANOMETALLIC SUBSTANCE, SOLID, SELF-HEATING
4.2	4.3	3393	ORGANOMETALLIC SUBSTANCE, SOLID, PYROPHORIC, WATER-REACTIVE
4.2	4.3	3394	ORGANOMETALLIC SUBSTANCE, LIQUID, PYROPHORIC, WATER-REACTIVE
4.2	8	3206	ALKALI METAL ALCOHOLATES, SELF-HEATING, CORROSIVE, N.O.S.
			<b>General entries</b>
4.2		2845	PYROPHORIC LIQUID, ORGANIC, N.O.S.
4.2		2846	PYROPHORIC SOLID, ORGANIC, N.O.S.
4.2		3088	SELF-HEATING SOLID, ORGANIC, N.O.S.
4.2		3183	SELF-HEATING LIQUID, ORGANIC, N.O.S.
4.2		3186	SELF-HEATING LIQUID, INORGANIC, N.O.S.
4.2		3190	SELF-HEATING SOLID, INORGANIC, N.O.S.
4.2		3194	PYROPHORIC LIQUID, INORGANIC, N.O.S.
4.2		3200	PYROPHORIC SOLID, INORGANIC, N.O.S.
4.2	5.1	3127	SELF-HEATING SOLID, OXIDIZING, N.O.S.
4.2	6.1	3128	SELF-HEATING SOLID, TOXIC, ORGANIC, N.O.S.
4.2	6.1	3184	SELF-HEATING LIQUID, TOXIC, ORGANIC, N.O.S.
4.2	6.1	3187	SELF-HEATING LIQUID, TOXIC, INORGANIC, N.O.S.
4.2	6.1	3191	SELF-HEATING SOLID, TOXIC, INORGANIC, N.O.S.
4.2	8	3126	SELF-HEATING SOLID, CORROSIVE, ORGANIC, N.O.S.
4.2	8	3185	SELF-HEATING LIQUID, CORROSIVE, ORGANIC, N.O.S.
4.2	8	3188	SELF-HEATING LIQUID, CORROSIVE, INORGANIC, N.O.S.
4.2	8	3192	SELF-HEATING SOLID, CORROSIVE, INORGANIC, N.O.S.
			<b>Class 4.3</b>
			<b>Specific entries</b>
4.3		1389	ALKALI METAL AMALGAM, LIQUID
4.3		1390	ALKALI METAL AMIDES
4.3		1391	ALKALI METAL DISPERSION or ALKALINE EARTH METAL DISPERSION
4.3		1392	ALKALINE EARTH METAL AMALGAM, LIQUID
4.3		1393	ALKALINE EARTH METAL ALLOY, N.O.S.
4.3		1409	METAL HYDRIDES, WATER-REACTIVE, N.O.S.
4.3		1421	ALKALI METAL ALLOY, LIQUID, N.O.S.
4.3		3208	METALLIC SUBSTANCE, WATER-REACTIVE, N.O.S.
4.3		3395	ORGANOMETALLIC SUBSTANCE, SOLID, WATER-REACTIVE
4.3		3398	ORGANOMETALLIC SUBSTANCE, LIQUID, WATER-REACTIVE
4.3		3401	ALKALI METAL AMALGAM, SOLID
4.3		3402	ALKALINE EARTH METAL AMALGAM, SOLID
4.3	3	3399	ORGANOMETALLIC SUBSTANCE, LIQUID, WATER-REACTIVE, FLAMMABLE
4.3	3	3482	ALKALI METAL DISPERSION, FLAMMABLE or ALKALINE EARTH METAL DISPERSION, FLAMMABLE
4.3	3 + 8	2988	CHLOROSILANES, WATER-REACTIVE, FLAMMABLE, CORROSIVE, N.O.S.
4.3	4.1	3396	ORGANOMETALLIC SUBSTANCE, SOLID, WATER-REACTIVE, FLAMMABLE
4.3	4.2	3209	METALLIC SUBSTANCE, WATER-REACTIVE, SELF-HEATING, N.O.S.
4.3	4.2	3397	ORGANOMETALLIC SUBSTANCE, SOLID, WATER-REACTIVE, SELF-HEATING
			<b>General entries</b>
4.3		3148	WATER-REACTIVE LIQUID, N.O.S.
4.3		2813	WATER-REACTIVE SOLID, N.O.S.
4.3	4.1	3132	WATER-REACTIVE SOLID, FLAMMABLE, N.O.S.
4.3	4.2	3135	WATER-REACTIVE SOLID, SELF-HEATING, N.O.S.
4.3	5.1	3133	WATER-REACTIVE SOLID, OXIDIZING, N.O.S.
4.3	6.1	3130	WATER-REACTIVE LIQUID, TOXIC, N.O.S.
4.3	6.1	3134	WATER-REACTIVE SOLID, TOXIC, N.O.S.
4.3	8	3129	WATER-REACTIVE LIQUID, CORROSIVE, N.O.S.
4.3	8	3131	WATER-REACTIVE SOLID, CORROSIVE, N.O.S.

*Appendix A – List of generic and N.O.S. Proper Shipping Names*

Class or division	Subsidiary risk	UN Number	Proper Shipping Name
			<b>CLASS 5</b>
			<b>Class 5.1</b>
			<b>Specific entries</b>
5.1		1450	BROMATES, INORGANIC, N.O.S.
5.1		1461	CHLORATES, INORGANIC, N.O.S.
5.1		1462	CHLORITES, INORGANIC, N.O.S.
5.1		1477	NITRATES, INORGANIC, N.O.S.
5.1		1481	PERCHLORATES, INORGANIC, N.O.S.
5.1		1482	PERMANGANATES, INORGANIC, N.O.S.
5.1		1483	PEROXIDES, INORGANIC, N.O.S.
5.1		2627	NITRITES, INORGANIC, N.O.S.
5.1		3210	CHLORATES, INORGANIC, AQUEOUS SOLUTION, N.O.S.
5.1		3211	PERCHLORATES, INORGANIC, AQUEOUS SOLUTION, N.O.S.
5.1		3212	HYPOCHLORITES, INORGANIC, N.O.S.
5.1		3213	BROMATES, INORGANIC, AQUEOUS SOLUTION, N.O.S.
5.1		3214	PERMANGANATES, INORGANIC, AQUEOUS SOLUTION, N.O.S.
5.1		3215	PERSULPHATES, INORGANIC, N.O.S.
5.1		3216	PERSULPHATES, INORGANIC, AQUEOUS SOLUTION, N.O.S.
5.1		3218	NITRATES, INORGANIC, AQUEOUS SOLUTION, N.O.S.
5.1		3219	NITRITES, INORGANIC, AQUEOUS SOLUTION, N.O.S.
			<b>General entries</b>
5.1		1479	OXIDIZING SOLID, N.O.S.
5.1		3139	OXIDIZING LIQUID, N.O.S.
5.1	4.1	3137	OXIDIZING SOLID, FLAMMABLE, N.O.S.
5.1	4.2	3100	OXIDIZING SOLID, SELF-HEATING, N.O.S.
5.1	4.3	3121	OXIDIZING SOLID, WATER-REACTIVE, N.O.S.
5.1	6.1	3087	OXIDIZING SOLID, TOXIC, N.O.S.
5.1	6.1	3099	OXIDIZING LIQUID, TOXIC, N.O.S.
5.1	8	3085	OXIDIZING SOLID, CORROSIVE, N.O.S.
5.1	8	3098	OXIDIZING LIQUID, CORROSIVE, N.O.S.
			<b>Class 5.2</b>
			<b>Specific entries</b>
5.2		3101	ORGANIC PEROXIDE TYPE B, LIQUID
5.2		3102	ORGANIC PEROXIDE TYPE B, SOLID
5.2		3103	ORGANIC PEROXIDE TYPE C, LIQUID
5.2		3104	ORGANIC PEROXIDE TYPE C, SOLID
5.2		3105	ORGANIC PEROXIDE TYPE D, LIQUID
5.2		3106	ORGANIC PEROXIDE TYPE D, SOLID
5.2		3107	ORGANIC PEROXIDE TYPE E, LIQUID
5.2		3108	ORGANIC PEROXIDE TYPE E, SOLID
5.2		3109	ORGANIC PEROXIDE TYPE F, LIQUID
5.2		3110	ORGANIC PEROXIDE TYPE F, SOLID
5.2		3111	ORGANIC PEROXIDE TYPE B, LIQUID, TEMPERATURE CONTROLLED
5.2		3112	ORGANIC PEROXIDE TYPE B, SOLID, TEMPERATURE CONTROLLED
5.2		3113	ORGANIC PEROXIDE TYPE C, LIQUID, TEMPERATURE CONTROLLED
5.2		3114	ORGANIC PEROXIDE TYPE C, SOLID, TEMPERATURE CONTROLLED
5.2		3115	ORGANIC PEROXIDE TYPE D, LIQUID, TEMPERATURE CONTROLLED
5.2		3116	ORGANIC PEROXIDE TYPE D, SOLID, TEMPERATURE CONTROLLED
5.2		3117	ORGANIC PEROXIDE TYPE E, LIQUID, TEMPERATURE CONTROLLED
5.2		3118	ORGANIC PEROXIDE TYPE E, SOLID, TEMPERATURE CONTROLLED
5.2		3119	ORGANIC PEROXIDE TYPE F, LIQUID, TEMPERATURE CONTROLLED
5.2		3120	ORGANIC PEROXIDE TYPE F, SOLID, TEMPERATURE CONTROLLED

Appendices

Class or division	Subsidiary risk	UN Number	Proper Shipping Name
			<b>CLASS 6</b>
			<b>Class 6.1</b>
			<b>Specific entries</b>
6.1		1544	ALKALOIDS, SOLID, N.O.S. or ALKALOID SALTS, SOLID, N.O.S.
6.1		1549	ANTIMONY COMPOUND, INORGANIC, SOLID, N.O.S.
6.1		1556	ARSENIC COMPOUND, LIQUID, N.O.S. inorganic, including: Arsenates, n.o.s., Arsenites, n.o.s., and Arsenic sulphides, n.o.s.
6.1		1557	ARSENIC COMPOUND, SOLID, N.O.S. inorganic, including: Arsenates, n.o.s., Arsenites, n.o.s., and Arsenic sulphides, n.o.s.
6.1		1564	BARIUM COMPOUND, N.O.S.
6.1		1566	BERYLLIUM COMPOUND, N.O.S.
6.1		1583	CHLOROPICRIN MIXTURE, N.O.S.
6.1		1588	CYANIDES, INORGANIC, SOLID, N.O.S.
6.1		1601	DISINFECTANT, SOLID, TOXIC, N.O.S.
6.1		1602	DYE, LIQUID, TOXIC, N.O.S. or DYE INTERMEDIATE, LIQUID, TOXIC, N.O.S.
6.1		1655	NICOTINE COMPOUND, SOLID, N.O.S. or NICOTINE PREPARATION, SOLID, N.O.S.
6.1		1693	TEAR GAS SUBSTANCE, LIQUID, N.O.S.
6.1		1707	THALLIUM COMPOUND, N.O.S.
6.1		1851	MEDICINE, LIQUID, TOXIC, N.O.S.
6.1		1935	CYANIDE SOLUTION, N.O.S.
6.1		2024	MERCURY COMPOUND, LIQUID, N.O.S.
6.1		2025	MERCURY COMPOUND, SOLID, N.O.S.
6.1		2026	PHENYLMERCURIC COMPOUND, N.O.S.
6.1		2206	ISOCYANATES, TOXIC, N.O.S. or ISOCYANATE SOLUTION, TOXIC, N.O.S.
6.1		2291	LEAD COMPOUND, SOLUBLE, N.O.S.
6.1		2570	CADMIUM COMPOUND
6.1		2788	ORGANOTIN COMPOUND, LIQUID, N.O.S.
6.1		2856	FLUOROSILICATES, N.O.S.
6.1		3140	ALKALOIDS, LIQUID, N.O.S. or ALKALOIDS SALTS, LIQUID, N.O.S.
6.1		3141	ANTIMONY COMPOUND, INORGANIC, LIQUID, N.O.S.
6.1		3142	DISINFECTANT, LIQUID, TOXIC, N.O.S.
6.1		3143	DYE, SOLID, TOXIC, N.O.S. or DYE INTERMEDIATE, SOLID, TOXIC, N.O.S.
6.1		3144	NICOTINE COMPOUND, LIQUID, N.O.S. or NICOTINE PREPARATION, LIQUID, N.O.S.
6.1		3146	ORGANOTIN COMPOUND, SOLID, N.O.S.
6.1		3249	MEDICINE, SOLID, TOXIC, N.O.S.
6.1		3276	NITRILES, TOXIC, LIQUID, N.O.S.
6.1		3278	ORGANOPHOSPHORUS COMPOUND, TOXIC, LIQUID, N.O.S.
6.1		3280	ORGANOARSENIC COMPOUND, LIQUID, N.O.S.
6.1		3281	METAL CARBONYLS, LIQUID, N.O.S. with LC <sub>50</sub>
6.1		3282	ORGANOMETALLIC COMPOUND, TOXIC, LIQUID, N.O.S. with LC <sub>50</sub>
6.1		3283	SELENIUM COMPOUND, SOLID, N.O.S. with LC <sub>50</sub>
6.1		3284	TELLURIUM COMPOUND, N.O.S. with LC <sub>50</sub>
6.1		3285	VANADIUM COMPOUND, N.O.S.
6.1		3439	NITRILES, TOXIC, SOLID, N.O.S.
6.1		3440	SELENIUM COMPOUND, LIQUID, N.O.S.
6.1		3448	TEAR GAS SUBSTANCE, SOLID, N.O.S.
6.1		3462	TOXINS EXTRACTED FROM LIVING SOURCES, SOLID, N.O.S.
6.1		3464	ORGANOPHOSPHORUS COMPOUND, TOXIC, SOLID, N.O.S.
6.1		3465	ORGANOARSENIC COMPOUND, SOLID, N.O.S.
6.1		3466	METAL CARBONYLS, SOLID, N.O.S.
6.1		3467	ORGANOMETALLIC COMPOUND, TOXIC, SOLID, N.O.S.
6.1	3	3071	MERCAPTANS, LIQUID, TOXIC, FLAMMABLE, N.O.S. or MERCAPTAN MIXTURE, LIQUID, TOXIC, FLAMMABLE, N.O.S.
6.1	3	3080	ISOCYANATES, TOXIC, FLAMMABLE, N.O.S. or ISOCYANATE SOLUTION, TOXIC, FLAMMABLE, N.O.S.
6.1	3	3275	NITRILES, TOXIC, FLAMMABLE, N.O.S.
6.1	3	3279	ORGANOPHOSPHORUS COMPOUND, TOXIC, FLAMMABLE, N.O.S.
6.1	3 + 8	2742	CHLOROFORMATES, TOXIC, CORROSIVE, FLAMMABLE, N.O.S.

Appendix A – List of generic and N.O.S. Proper Shipping Names

Class or division	Subsidiary risk	UN Number	Proper Shipping Name
			CLASS 6 (continued)
			Class 6.1 (continued)
			Specific entries (continued)
6.1	3 + 8	3362	CHLOROSILANES, TOXIC, CORROSIVE, FLAMMABLE, N.O.S.
6.1	8	3277	CHLOROFORMATES, TOXIC, CORROSIVE, N.O.S.
6.1	8	3361	CHLOROSILANES, TOXIC, CORROSIVE, N.O.S.
			Pesticides
			(a) Solid
6.1		2588	PESTICIDE, SOLID, TOXIC, N.O.S.
6.1		2757	CARBAMATE PESTICIDE, SOLID, TOXIC
6.1		2759	ARSENICAL PESTICIDE, SOLID, TOXIC
6.1		2761	ORGANOCHLORINE PESTICIDE, SOLID, TOXIC
6.1		2763	TRIAZINE PESTICIDE, SOLID, TOXIC
6.1		2771	THIOCARBAMATE PESTICIDE, SOLID, TOXIC
6.1		2775	COPPER BASED PESTICIDE, SOLID, TOXIC
6.1		2777	MERCURY BASED PESTICIDE, SOLID, TOXIC
6.1		2779	SUBSTITUTED NITROPHENOL PESTICIDE, SOLID, TOXIC
6.1		2781	BIPYRIDILUM PESTICIDE, SOLID, TOXIC
6.1		2783	ORGANOPHOSPHORUS PESTICIDE, SOLID, TOXIC
6.1		2786	ORGANOTIN PESTICIDE, SOLID, TOXIC
6.1		3027	COUMARIN DERIVATIVE PESTICIDE, SOLID, TOXIC
6.1		3345	PHENOXYACETIC ACID DERIVATIVE PESTICIDE, SOLID, TOXIC
6.1		3349	PYRETHROID PESTICIDE, SOLID, TOXIC
			(b) Liquid
6.1		2902	PESTICIDE, LIQUID TOXIC, N.O.S.
6.1		2992	CARBAMATE PESTICIDE, LIQUID, TOXIC
6.1		2994	ARSENICAL PESTICIDE, LIQUID, TOXIC
6.1		2996	ORGANOCHLORINE PESTICIDE, LIQUID, TOXIC
6.1		2998	TRIAZINE PESTICIDE, LIQUID, TOXIC
6.1		3006	THIOCARBAMATE PESTICIDE, LIQUID, TOXIC
6.1		3010	COPPER BASED PESTICIDE, LIQUID, TOXIC
6.1		3012	MERCURY BASED PESTICIDE, LIQUID, TOXIC
6.1		3014	SUBSTITUTED NITROPHENOL PESTICIDE, LIQUID, TOXIC
6.1		3016	BIPYRIDILUM PESTICIDE, LIQUID, TOXIC
6.1		3018	ORGANOPHOSPHORUS PESTICIDE, LIQUID, TOXIC
6.1		3020	ORGANOTIN PESTICIDE, LIQUID, TOXIC
6.1		3026	COUMARIN DERIVATIVE PESTICIDE, LIQUID, TOXIC
6.1		3348	PHENOXYACETIC ACID DERIVATIVE PESTICIDE, LIQUID, TOXIC
6.1		3352	PYRETHROID PESTICIDE, LIQUID, TOXIC
6.1	3	2903	PESTICIDE, LIQUID, TOXIC, FLAMMABLE, N.O.S., flashpoint $\geq 23^{\circ}\text{C}$
6.1	3	2991	CARBAMATE PESTICIDE, LIQUID, TOXIC, FLAMMABLE, flashpoint $\geq 23^{\circ}\text{C}$
6.1	3	2993	ARSENICAL PESTICIDE, LIQUID, TOXIC, FLAMMABLE flashpoint $\geq 23^{\circ}\text{C}$
6.1	3	2995	ORGANOCHLORINE PESTICIDE, LIQUID, TOXIC, FLAMMABLE flashpoint $\geq 23^{\circ}\text{C}$
6.1	3	2997	TRIAZINE PESTICIDE, LIQUID, TOXIC, FLAMMABLE, flashpoint $\geq 23^{\circ}\text{C}$
6.1	3	3005	THIOCARBAMATE PESTICIDE, LIQUID, TOXIC, FLAMMABLE flashpoint $\geq 23^{\circ}\text{C}$
6.1	3	3009	COPPER BASED PESTICIDE, LIQUID, TOXIC, FLAMMABLE flashpoint $\geq 23^{\circ}\text{C}$
6.1	3	3011	MERCURY BASED PESTICIDE, LIQUID, TOXIC, FLAMMABLE flashpoint $\geq 23^{\circ}\text{C}$
6.1	3	3013	SUBSTITUTED NITROPHENOL PESTICIDE, LIQUID, TOXIC, FLAMMABLE flashpoint $\geq 23^{\circ}\text{C}$
6.1	3	3015	BIPYRIDILUM PESTICIDE, LIQUID, TOXIC, FLAMMABLE flashpoint $\geq 23^{\circ}\text{C}$
6.1	3	3017	ORGANOPHOSPHORUS PESTICIDE, LIQUID, TOXIC, FLAMMABLE flashpoint $\geq 23^{\circ}\text{C}$
6.1	3	3019	ORGANOTIN PESTICIDE, LIQUID, TOXIC, FLAMMABLE flashpoint $\geq 23^{\circ}\text{C}$
6.1	3	3025	COUMARIN DERIVATIVE PESTICIDE, LIQUID, TOXIC, FLAMMABLE flashpoint $\geq 23^{\circ}\text{C}$
6.1	3	3347	PHENOXYACETIC ACID DERIVATIVE PESTICIDE, LIQUID, TOXIC, FLAMMABLE flashpoint $\geq 23^{\circ}\text{C}$
6.1	3	3351	PYRETHROID PESTICIDE, LIQUID, TOXIC, FLAMMABLE flashpoint $\geq 23^{\circ}\text{C}$

Appendices

Class or division	Subsidiary risk	UN Number	Proper Shipping Name
			CLASS 6 (continued)
			Class 6.1 (continued)
			General entries
6.1		2810	TOXIC LIQUID, ORGANIC, N.O.S.
6.1		2811	TOXIC SOLID, ORGANIC, N.O.S.
6.1		3172	TOXINS, EXTRACTED FROM LIVING SOURCES, LIQUID, N.O.S.
6.1		3243	SOLIDS CONTAINING TOXIC LIQUID, N.O.S.
6.1		3287	TOXIC LIQUID, INORGANIC, N.O.S.
6.1		3288	TOXIC SOLID, INORGANIC, N.O.S.
6.1		3315	CHEMICAL SAMPLE, TOXIC
6.1		3381	TOXIC BY INHALATION LIQUID, N.O.S. with an LC <sub>50</sub> lower than or equal to 200 ml/m <sup>3</sup> and saturated vapour concentration greater than or equal to 500 LC <sub>50</sub>
6.1		3382	TOXIC BY INHALATION LIQUID, N.O.S. with an LC <sub>50</sub> lower than or equal to 1000 ml/m <sup>3</sup> and saturated vapour concentration greater than or equal to 10 LC <sub>50</sub>
6.1		3462	TOXINS, EXTRACTED FROM LIVING SOURCES, SOLID, N.O.S.
6.1	3	2929	TOXIC LIQUID, FLAMMABLE, ORGANIC, N.O.S.
6.1	3	3383	TOXIC BY INHALATION LIQUID, FLAMMABLE, N.O.S. with an LC <sub>50</sub> lower than or equal to 200 ml/m <sup>3</sup> and saturated vapour concentration greater than or equal to 500 LC <sub>50</sub>
6.1	3	3384	TOXIC BY INHALATION LIQUID, FLAMMABLE, N.O.S. with an LC <sub>50</sub> lower than or equal to 1000 ml/m <sup>3</sup> and saturated vapour concentration greater than or equal to 10 LC <sub>50</sub>
6.1	3 + 8	3488	TOXIC BY INHALATION LIQUID, FLAMMABLE, CORROSIVE, N.O.S. with an LC <sub>50</sub> lower than or equal to 200 ml/m <sup>3</sup> and saturated vapour concentration greater than or equal to 500 LC <sub>50</sub>
6.1	3 + 8	3489	TOXIC BY INHALATION LIQUID, FLAMMABLE, CORROSIVE, N.O.S. with an LC <sub>50</sub> lower than or equal to 1000 ml/m <sup>3</sup> and saturated vapour concentration greater than or equal to 10 LC <sub>50</sub>
6.1	4.1	2930	TOXIC SOLID, FLAMMABLE, ORGANIC, N.O.S.
6.1	4.2	3124	TOXIC SOLID, SELF-HEATING, N.O.S.
6.1	4.3	3123	TOXIC LIQUID, WATER-REACTIVE, N.O.S.
6.1	4.3	3125	TOXIC SOLID, WATER-REACTIVE, N.O.S.
6.1	4.3	3385	TOXIC BY INHALATION LIQUID, WATER-REACTIVE, N.O.S. with an LC <sub>50</sub> lower than or equal to 200 ml/m <sup>3</sup> and saturated vapour concentration greater than or equal to 500 LC <sub>50</sub>
6.1	4.3	3386	TOXIC BY INHALATION LIQUID, WATER-REACTIVE, N.O.S. with an LC <sub>50</sub> lower than or equal to 1000 ml/m <sup>3</sup> and saturated vapour concentration greater than or equal to 10 LC <sub>50</sub>
6.1	4.3 + 3	3490	TOXIC BY INHALATION LIQUID, WATER-REACTIVE, FLAMMABLE, N.O.S. with an LC <sub>50</sub> lower than or equal to 200 ml/m <sup>3</sup> and saturated vapour concentration greater than or equal to 500 LC <sub>50</sub>
6.1	4.3 + 3	3491	TOXIC BY INHALATION LIQUID, WATER-REACTIVE, FLAMMABLE, N.O.S. with an LC <sub>50</sub> lower than or equal to 1000 ml/m <sup>3</sup> and saturated vapour concentration greater than or equal to 10 LC <sub>50</sub>
6.1	5.1	3122	TOXIC LIQUID, OXIDIZING, N.O.S.
6.1	5.1	3086	TOXIC SOLID, OXIDIZING, N.O.S.
6.1	5.1	3387	TOXIC BY INHALATION LIQUID, OXIDIZING, N.O.S. with an LC <sub>50</sub> lower than or equal to 200 ml/m <sup>3</sup> and saturated vapour concentration greater than or equal to 500 LC <sub>50</sub>
6.1	5.1	3388	TOXIC BY INHALATION LIQUID, OXIDIZING, N.O.S. with an LC <sub>50</sub> lower than or equal to 1000 ml/m <sup>3</sup> and saturated vapour concentration greater than or equal to 10 LC <sub>50</sub>
6.1	8	2927	TOXIC LIQUID, CORROSIVE, ORGANIC, N.O.S.
6.1	8	2928	TOXIC SOLID, CORROSIVE, ORGANIC, N.O.S.
6.1	8	3289	TOXIC LIQUID, CORROSIVE, INORGANIC, N.O.S.
6.1	8	3290	TOXIC SOLID, CORROSIVE, INORGANIC, N.O.S.
6.1	8	3389	TOXIC BY INHALATION LIQUID, CORROSIVE, N.O.S. with an LC <sub>50</sub> lower than or equal to 200 ml/m <sup>3</sup> and saturated vapour concentration greater than or equal to 500 LC <sub>50</sub>
6.1	8	3390	TOXIC BY INHALATION LIQUID, CORROSIVE, N.O.S. with an LC <sub>50</sub> lower than or equal to 1000 ml/m <sup>3</sup> and saturated vapour concentration greater than or equal to 10 LC <sub>50</sub>

Appendix A – List of generic and N.O.S. Proper Shipping Names

Class or division	Subsidiary risk	UN Number	Proper Shipping Name
			<b>CLASS 6 (continued)</b>
			<b>Class 6.2</b>
			<b>Specific entries</b>
6.2		3291	CLINICAL WASTE, UNSPECIFIED, N.O.S. or (BIO)MEDICAL WASTE, N.O.S. or REGULATED MEDICAL WASTE, N.O.S.
6.2		3373	BIOLOGICAL SUBSTANCE, CATEGORY B
			<b>General entries</b>
6.2		2814	INFECTIOUS SUBSTANCE, AFFECTING HUMANS
6.2		2900	INFECTIOUS SUBSTANCE, AFFECTING ANIMALS only

Appendices

Class or division	Subsidiary risk	UN Number	Proper Shipping Name
			<b>CLASS 7</b>
			<b>General entries</b>
7		2908	RADIOACTIVE MATERIAL, EXCEPTED PACKAGE – EMPTY PACKAGING
7		2909	RADIOACTIVE MATERIAL, EXCEPTED PACKAGE – ARTICLES MANUFACTURED FROM NATURAL URANIUM or DEPLETED URANIUM or NATURAL THORIUM
7		2910	RADIOACTIVE MATERIAL, EXCEPTED PACKAGE – LIMITED QUANTITY OF MATERIAL
7		2911	RADIOACTIVE MATERIAL, EXCEPTED PACKAGE – INSTRUMENTS or ARTICLES
7		2912	RADIOACTIVE MATERIAL, LOW SPECIFIC ACTIVITY (LSA-I) non fissile or fissile – excepted
7		2913	RADIOACTIVE MATERIAL, SURFACE CONTAMINATED OBJECTS (SCO-I or SCO-II) non fissile or fissile – excepted
7		2915	RADIOACTIVE MATERIAL, TYPE A PACKAGE, non-special form, non fissile or fissile – excepted
7		2916	RADIOACTIVE MATERIAL, TYPE B(U) PACKAGE non fissile or fissile – excepted
7		2917	RADIOACTIVE MATERIAL, TYPE B(M) PACKAGE non fissile or fissile – excepted
7		2919	RADIOACTIVE MATERIAL, TRANSPORTED UNDER SPECIAL ARRANGEMENT non fissile or fissile – excepted
7		3321	RADIOACTIVE MATERIAL, LOW SPECIFIC ACTIVITY (LSA-II), non fissile or fissile – excepted
7		3322	RADIOACTIVE MATERIAL, LOW SPECIFIC ACTIVITY (LSA-III), non fissile or fissile – excepted
7		3323	RADIOACTIVE MATERIAL, TYPE C PACKAGE non fissile or fissile – excepted
7		3324	RADIOACTIVE MATERIAL, LOW SPECIFIC ACTIVITY (LSA-II), FISSILE
7		3325	RADIOACTIVE MATERIAL, LOW SPECIFIC ACTIVITY (LSA-III), FISSILE
7		3326	RADIOACTIVE MATERIAL, SURFACE CONTAMINATED OBJECTS (SCO-I or SCO-II), FISSILE
7		3327	RADIOACTIVE MATERIAL, TYPE A PACKAGE, FISSILE non-special form
7		3328	RADIOACTIVE MATERIAL, TYPE B(U) PACKAGE, FISSILE
7		3329	RADIOACTIVE MATERIAL, TYPE B(M) PACKAGE, FISSILE
7		3330	RADIOACTIVE MATERIAL, TYPE C PACKAGE, FISSILE
7		3331	RADIOACTIVE MATERIAL, TRANSPORTED UNDER SPECIAL ARRANGEMENT, FISSILE
7		3332	RADIOACTIVE MATERIAL, TYPE A PACKAGE, SPECIAL FORM non fissile or fissile – excepted
7		3333	RADIOACTIVE MATERIAL, TYPE A PACKAGE, SPECIAL FORM, FISSILE



Appendix A – List of generic and N.O.S. Proper Shipping Names

Class or division	Subsidiary risk	UN Number	Proper Shipping Name
			<b>CLASS 8</b>
			<b>Specific entries</b>
8		1719	CAUSTIC ALKALI LIQUID, N.O.S.
8		1740	HYDROGENDIFLUORIDES, SOLID, N.O.S.
8		1903	DISINFECTANT, LIQUID, CORROSIVE, N.O.S.
8		2430	ALKYLPHENOLS, SOLID, N.O.S. (including C <sub>2</sub> -C <sub>12</sub> homologues)
8		2693	BISULPHITES, AQUEOUS SOLUTION, N.O.S.
8		2735	AMINES, LIQUID, CORROSIVE, N.O.S. or POLYAMINES, LIQUID, CORROSIVE, N.O.S.
8		2801	DYE, LIQUID, CORROSIVE, N.O.S. or DYE INTERMEDIATE, LIQUID, CORROSIVE, N.O.S.
8		2837	BISULPHATES, AQUEOUS SOLUTION
8		2987	CHLOROSILANES, CORROSIVE, N.O.S.
8		3145	ALKYLPHENOLS, LIQUID, N.O.S. (including C <sub>2</sub> -C <sub>12</sub> homologues)
8		3147	DYE, SOLID, CORROSIVE, N.O.S. or DYE INTERMEDIATE, SOLID, CORROSIVE, N.O.S.
8		3259	AMINES, SOLID, CORROSIVE, N.O.S. or POLYAMINES, SOLID, CORROSIVE, N.O.S.
8	3	2734	AMINES, LIQUID, CORROSIVE, FLAMMABLE, N.O.S. or POLYAMINES, LIQUID, CORROSIVE, FLAMMABLE, N.O.S.
8	3	2986	CHLOROSILANES, CORROSIVE, FLAMMABLE, N.O.S.
8	6.1	3471	HYDROGENDIFLUORIDES SOLUTION, N.O.S.
			<b>General entries</b>
8		1759	CORROSIVE SOLID, N.O.S.
8		1760	CORROSIVE LIQUID, N.O.S.
8		3244	SOLIDS CONTAINING CORROSIVE LIQUID, N.O.S.
8		3260	CORROSIVE SOLID, ACIDIC, INORGANIC, N.O.S.
8		3261	CORROSIVE SOLID, ACIDIC, ORGANIC, N.O.S.
8		3262	CORROSIVE SOLID, BASIC, INORGANIC, N.O.S.
8		3263	CORROSIVE SOLID, BASIC, ORGANIC, N.O.S.
8		3264	CORROSIVE LIQUID, ACIDIC, INORGANIC, N.O.S.
8		3265	CORROSIVE LIQUID, ACIDIC, ORGANIC, N.O.S.
8		3266	CORROSIVE LIQUID, BASIC, INORGANIC, N.O.S.
8		3267	CORROSIVE LIQUID, BASIC, ORGANIC, N.O.S.
8	3	2920	CORROSIVE LIQUID, FLAMMABLE, N.O.S.
8	4.1	2921	CORROSIVE SOLID, FLAMMABLE, N.O.S.
8	4.2	3095	CORROSIVE SOLID, SELF-HEATING, N.O.S.
8	4.2	3301	CORROSIVE LIQUID, SELF-HEATING, N.O.S.
8	4.3	3094	CORROSIVE LIQUID, WATER-REACTIVE, N.O.S.
8	4.3	3096	CORROSIVE SOLID, WATER-REACTIVE, N.O.S.
8	5.1	3084	CORROSIVE SOLID, OXIDIZING, N.O.S.
8	5.1	3093	CORROSIVE LIQUID, OXIDIZING, N.O.S.
8	6.1	2922	CORROSIVE LIQUID, TOXIC, N.O.S.
8	6.1	2923	CORROSIVE SOLID, TOXIC, N.O.S.

Class or division	Subsidiary risk	UN Number	Proper Shipping Name
			<b>CLASS 9</b>
			<b>General entries</b>
9		3077	ENVIRONMENTALLY HAZARDOUS SUBSTANCE, SOLID, N.O.S.
9		3082	ENVIRONMENTALLY HAZARDOUS SUBSTANCE, LIQUID, N.O.S.
9		3245	GENETICALLY MODIFIED MICROORGANISMS or GENETICALLY MODIFIED ORGANISMS
9		3257	ELEVATED TEMPERATURE LIQUID, N.O.S. at or above 100°C and below its flashpoint (including molten metals, molten salts, etc.)
9		3258	ELEVATED TEMPERATURE SOLID, N.O.S., at or above 240°C
see SP960		3334	AVIATION REGULATED LIQUID, N.O.S.
see SP960		3335	AVIATION REGULATED SOLID, N.O.S.



## Appendix B

### *Glossary of terms*

---

**Note:** The provisions of this appendix are not mandatory.

**Caution:** The explanations in this glossary are for information only and are not to be used for purposes of hazard classification.

**AIR BAG INFLATORS, PYROTECHNIC or AIR BAG MODULES, PYROTECHNIC or SEAT-BELT PRETENSIONERS, PYROTECHNIC**

Articles which contain pyrotechnic substances and are used as life-saving vehicle air bags or seat-belts.

**Ammunition**

Generic term related mainly to articles of military application consisting of all kind of bombs, grenades, rockets, mines, projectiles and other similar devices or contrivances.

**AMMUNITION, ILLUMINATING with or without burster, expelling charge or propelling charge**

Ammunition designed to produce a single source of intense light for lighting up an area. The term includes illuminating cartridges, grenades and projectiles; and illuminating and target identification bombs. The term excludes the following articles which are listed separately: CARTRIDGES, SIGNAL; SIGNAL DEVICES, HAND; SIGNALS, DISTRESS; FLARES, AERIAL and FLARES, SURFACE.

**AMMUNITION, INCENDIARY**

Ammunition containing incendiary substances which may be a solid, liquid or gel including white phosphorus. Except when the composition is an explosive *per se*, it also contains one or more of the following: a propelling charge with primer and igniter charge; a fuze with burster or expelling charge. The term includes:

AMMUNITION, INCENDIARY, liquid or gel, with burster, expelling charge  
or propelling charge;

AMMUNITION, INCENDIARY with or without burster, expelling charge or propelling charge;

AMMUNITION, INCENDIARY, WHITE PHOSPHORUS with burster, expelling charge or propelling charge.

**AMMUNITION, PRACTICE**

Ammunition without a main bursting charge, containing a burster or expelling charge. Normally it also contains a fuze and a propelling charge. The term excludes the following articles which are listed separately: GRENADES, PRACTICE.

**AMMUNITION, PROOF**

Ammunition containing pyrotechnic substances, used to test the performance or strength of new ammunition, weapon component or assemblies.

## Appendices

<b>AMMUNITION, SMOKE</b>	Ammunition containing smoke producing substance such as chlorosulphonic acid mixture, titanium tetrachloride or white phosphorus; or smoke producing pyrotechnic composition based on hexachloroethane or red phosphorus. Except when the substance is an explosive per se, the ammunition also contains one or more of the following: a propelling charge with primer and igniter charge; a fuze with burster or expelling charge. The term includes grenades, smoke but excludes SIGNALS, SMOKE which are listed separately. The term includes: AMMUNITION, SMOKE with or without burster, expelling charge or propelling charge; AMMUNITION, SMOKE, WHITE PHOSPHORUS with burster, expelling charge or propelling charge.
<b>AMMUNITION, TEAR PRODUCING with burster, expelling charge or propelling charge</b>	Ammunition containing tear producing substance. It also contains one or more of the following: a pyrotechnic substance; a propelling charge with primer and igniter charge; a fuze with burster or expelling charge.
<b>AMMUNITION, TOXIC with burster, expelling charge or propelling charge</b>	Ammunition containing toxic agent. It also contains one or more of the following: a pyrotechnic substance; a propelling charge with primer and igniter charge; a fuze with burster or expelling charge.
<b>ARTICLES, EXPLOSIVE, EXTREMELY INSENSITIVE (ARTICLES, EEI)</b>	Articles that contain only extremely insensitive substances and which demonstrate a negligible probability of accidental initiation or propagation (under normal conditions of transport) and which have passed Test Series 7.
<b>ARTICLES, PYROPHORIC</b>	Articles which contain a pyrophoric substance (capable of spontaneous ignition when exposed to air) and an explosive substance or component. The term excludes articles containing white phosphorus.
<b>ARTICLES, PYROTECHNIC for technical purposes</b>	Articles which contain pyrotechnic substances and are used for technical purposes such as heat generation, gas generation, theatrical effects, etc. The term excludes the following articles which are listed separately: all ammunition; CARTRIDGES, SIGNAL; CUTTERS, CABLE, EXPLOSIVE; FIREWORKS; FLARES, AERIAL; FLARES, SURFACE; RELEASE DEVICES, EXPLOSIVE; RIVETS, EXPLOSIVE; SIGNAL DEVICES, HAND; SIGNALS, DISTRESS; SIGNALS, RAILWAY TRACK, EXPLOSIVE; SIGNALS, SMOKE.
<b>Auxiliary explosive component, isolated</b>	An "isolated auxiliary explosive component" is a small device that explosively performs an operation related to the article's functioning, other than its main explosive loads' performance. Functioning of the component does not cause any reaction of the main explosive loads contained within the article.
<b>BLACK POWDER (GUNPOWDER)</b>	Substance consisting of an intimate mixture of charcoal or other carbon and either potassium nitrate or sodium nitrate, with or without sulphur. It may be meal, granular, compressed or pelletized.
<b>Bombs</b>	Explosive articles which are dropped from aircraft. They may contain a flammable liquid with bursting charge, a photo flash composition or a bursting charge. The term excludes torpedoes (aerial) and includes: BOMBS, PHOTO FLASH; BOMBS with bursting charge; BOMBS WITH FLAMMABLE LIQUID with bursting charge.

<b>BOOSTERS</b>	Articles consisting of a charge of detonating explosive with or without means of initiation. They are used to increase the initiating power of detonators or detonating cord.
<b>BURSTERS, explosive</b>	Articles consisting of a small charge of explosive used to open projectiles, or other ammunition in order to disperse their contents.
<b>Cartridges, blank</b>	Articles which consist of a cartridge case with a centre or rim fire primer and a confined charge of smokeless or black powder but no projectile. Used for training, saluting or in starter pistols, tools, etc.
<b>CARTRIDGES, FLASH</b>	Articles consisting of a casing, a primer and flash powder, all assembled in one piece ready for firing.
<b>Cartridges for Weapons</b>	<p>(1) Fixed (assembled) or semi fixed (partially assembled) ammunition designed to be fired from weapons. Each cartridge includes all the components necessary to function the weapon once. The name and description shall be used for small arms cartridges that cannot be described as "cartridges, small arms". Separate loading ammunition is included under this name and description when the propelling charge and projectile are packed together (see also "Cartridges, blank").</p> <p>(2) Incendiary, smoke, toxic and tear producing cartridges are described in this Glossary under AMMUNITION, INCENDIARY etc.</p>
<b>CARTRIDGES FOR WEAPONS, INERT PROJECTILE</b>	Ammunition consisting of a projectile without bursting charge but with a propelling charge. The presence of a tracer can be disregarded for classification purposes provided that the predominant hazard is that of the propelling charge.
<b>CARTRIDGES, OIL WELL</b>	Articles consisting of a casing of thin fibre, metal or other material containing only propellant which projects a hardened projectile. The term excludes the following articles which are listed separately: CHARGES, SHAPED.
<b>CARTRIDGES, POWER DEVICE</b>	Articles designed to accomplish mechanical actions. They consist of a casing with a charge of deflagrating explosive and a means of ignition. The gaseous products of the deflagration produce inflation, or linear or rotary motion, or activate diaphragms, valves or switches or project fastening devices or extinguishing agents.
<b>CARTRIDGES, SIGNAL</b>	Articles designed to fire coloured flares or other signals from signal pistols, etc.
<b>CARTRIDGES, SMALL ARMS</b>	Ammunition consisting of a cartridge case fitted with a centre or rim fire primer and containing both a propelling charge and a solid projectile. They are designed to be fired in weapons of calibre not larger than 19.1 mm. Shot gun cartridges of any calibre are included in this description. The term excludes: CARTRIDGES, SMALL ARMS, BLANK listed separately in the Dangerous Goods List; and some small arms cartridges which are listed under CARTRIDGES FOR WEAPONS, INERT PROJECTILE.
<b>CASES, CARTRIDGE, EMPTY, WITH PRIMER</b>	Articles consisting of a cartridge case made from metal, plastics or other non flammable material, in which the only explosive component is the primer.
<b>CASES, COMBUSTIBLE, EMPTY, WITHOUT PRIMER</b>	Articles consisting of cartridge cases made partly or entirely from nitrocellulose.

## Appendices

Charges, bursting	Articles consisting of a charge of detonating explosive such as hexolite, octolite or plastics bonded explosive designed to produce effect by blast or fragmentation.
CHARGES, DEMOLITION	Articles containing a charge of a detonating explosive in a casing of fibreboard, plastics, metal or other material. The term excludes the following articles which are listed separately: bombs, mines, etc.
CHARGES, DEPTH	Articles consisting of a charge of detonating explosive contained in a drum or projectile. They are designed to detonate under water.
Charges, expelling	A charge of deflagrating explosive designed to eject the payload from the parent articles without damage.
CHARGES, EXPLOSIVE, COMMERCIAL without detonator	Articles consisting of a charge of detonating explosive without means of initiation, used for explosive welding, jointing, forming and other metallurgical processes.
CHARGES, PROPELLING	Articles consisting of a propellant charge in any physical form, with or without a casing, for use as a component of rocket motors or for reducing the drag of projectiles.
CHARGES, PROPELLING FOR CANNON	Articles consisting of a propellant charge in any physical form, with or without a casing, for use in a cannon.
CHARGES, SHAPED, without detonator	Articles consisting of a casing containing a charge of detonating explosive with a cavity lined with rigid material, without means of initiation. They are designed to produce a powerful, penetrating jet effect.
CHARGES, SHAPED, FLEXIBLE, LINEAR	Articles consisting of a V-shaped core of a detonating explosive clad by a flexible metal sheath.
CHARGES, SUPPLEMENTARY, EXPLOSIVE	Articles consisting of a small removable booster used in the cavity of a projectile between the fuze and the bursting charge.
COMPONENTS, EXPLOSIVE TRAIN, N.O.S.	Articles containing an explosive designed to transmit the detonation or deflagration within an explosive train.
CONTRIVANCES, WATER ACTIVATED with burster, expelling charge or propelling charge	Articles whose functioning depends upon physico chemical reaction of their contents with water.
CORD, DETONATING, flexible	Article consisting of a core of detonating explosive enclosed in spun fabric, with plastics or other covering unless the spun fabric is sift proof.
CORD (FUSE), DETONATING, metal clad	Article consisting of a core of detonating explosive clad by a soft metal tube with or without protective covering. When the core contains a sufficiently small quantity of explosive, the words "MILD EFFECT" are added.
CORD, IGNITER	Article consisting of textile yarns covered with black powder or another fast burning pyrotechnic composition and of a flexible protective covering; or it consists of a core of black powder surrounded by a flexible woven fabric. It burns progressively along its length with an external flame and is used to transmit ignition from a device to a charge or primer.
CUTTERS, CABLE, EXPLOSIVE	Articles consisting of a knife edged device which is driven by a small charge of deflagrating explosive into an anvil.
DETONATOR ASSEMBLIES, NON ELECTRIC for blasting	Non electric detonators assembled with and activated by such means as safety fuse, shock tube, flash tube or detonating cord. They may be of instantaneous design or incorporate delay elements. Detonating relays incorporating detonating cord are included. Other detonating relays are included in "Detonators, non electric".

<b>Detonators</b>	<p>Articles consisting of a small metal or plastics tube containing explosives such as lead azide, PETN or combinations of explosives. They are designed to start a detonation train. They may be constructed to detonate instantaneously, or may contain a delay element. The term includes:</p> <p style="padding-left: 40px;">DETONATORS FOR AMMUNITION and  DETONATORS for blasting, both ELECTRIC and NON ELECTRIC.</p> <p>Detonating relays without flexible detonating cord are included.</p>
<b>Entire load and total contents</b>	<p>The phrases “entire load” and “total contents” mean such a substantial proportion that the practical hazard shall be assessed by assuming simultaneous explosion of the whole of the explosive content of the load or package.</p>
<b>Explode</b>	<p>The verb used to indicate those explosive effects capable of endangering life and property through blast, heat and projection of missiles. It encompasses both deflagration and detonation.</p>
<b>Explosion of the total contents</b>	<p>The phrase “explosion of the total contents” is used in testing a single article or package or a small stack of articles or packages.</p>
<b>Explosive, blasting</b>	<p>Detonating explosive substances used in mining, construction and similar tasks. Blasting explosives are assigned to one of five types. In addition to the ingredients listed, blasting explosives may also contain inert components such as kieselguhr, and minor ingredients such as colouring agents and stabilizers.</p>
<b>EXPLOSIVE, BLASTING, TYPE A</b>	<p>Substances consisting of liquid organic nitrates such as nitroglycerin or a mixture of such ingredients with one or more of the following: nitrocellulose; ammonium nitrate or other inorganic nitrates; aromatic nitro derivatives, or combustible materials, such as wood meal and aluminium powder. Such explosives shall be in powdery, gelatinous or elastic form.</p> <p>The term includes dynamite gelatine, blasting and gelatine dynamites.</p>
<b>EXPLOSIVE, BLASTING, TYPE B</b>	<p>Substances consisting of (a) a mixture of ammonium nitrate or other inorganic nitrates with an explosive such as trinitrotoluene, with or without other substances such as wood meal and aluminium powder, or (b) a mixture of ammonium nitrate or other inorganic nitrates with other combustible substances which are not explosive ingredients. Such explosives shall not contain nitroglycerin, similar liquid organic nitrates, or chlorates.</p>
<b>EXPLOSIVE, BLASTING, TYPE C</b>	<p>Substances consisting of a mixture of either potassium or sodium chlorate or potassium, sodium or ammonium perchlorate with organic nitro derivatives or combustible materials such as wood meal or aluminium powder or a hydrocarbon. Such explosives shall not contain nitroglycerin or similar liquid organic nitrates.</p>
<b>EXPLOSIVE, BLASTING, TYPE D</b>	<p>Substances consisting of a mixture of organic nitrated compounds and combustible materials such as hydrocarbons and aluminium powder. Such explosives shall not contain nitroglycerin, similar liquid organic nitrates, chlorates or ammonium nitrate. The term generally includes plastic explosives.</p>

<b>EXPLOSIVE, BLASTING, TYPE E</b>	Substances consisting of water as an essential ingredient and high proportions of ammonium nitrate or other oxidizers, some or all of which are in solution. The other constituents may include nitro derivatives such as trinitrotoluene, hydrocarbons or aluminium powder.  The term includes explosives, emulsion; explosives slurry and explosives, water gel.
Explosive, deflagrating	A substance which reacts by detonation rather than deflagration when initiated and used in its normal manner.
Explosive, extremely insensitive substance (EIS)	A substance which has demonstrated through tests that it is so insensitive that there is very little probability of accidental initiation.
Explosive, primary	Explosive substance manufactured with a view to producing a practical effect by explosion which is very sensitive to heat, impact or friction and which, even in very small quantities, either detonates or burns very rapidly. It is able to transmit detonation (in the case of initiating explosive) or deflagration to secondary explosives close to it. The main primary explosives are mercury fulminate, lead azide and lead styphnate.
Explosive, secondary	Explosive substance which is relatively insensitive (when compared to primary explosives), which is usually initiated by primary explosives with or without the aid of boosters or supplementary charges. Such an explosive may react as a deflagrating or as a detonating explosive.
<b>FIREWORKS</b>	Pyrotechnic articles designed for entertainment.
Flares	Articles containing pyrotechnic substances which are designed for use to illuminate, identify, signal or warn. The term includes:  FLARES, AERIAL; FLARES, SURFACE.
<b>FLASH POWDER</b>	Pyrotechnic substance which, when ignited, produces an intense light.
<b>FRACTURING DEVICES, EXPLOSIVE for oil wells, without detonator</b>	Articles consisting of a charge of detonating explosive contained in a casing without means of initiation. They are used to fracture the rock around a drill shaft to assist the flow of crude oil from the rock.
Fuse/Fuze (English text only)	Although these two words have a common origin (French fusée, fusil) and are sometimes considered to be different spellings, it is useful to maintain the convention that fuse refers to a cord like igniting device whereas fuze refers to a device used in ammunition which incorporates mechanical, electrical, chemical or hydrostatic components to initiate a train by deflagration or detonation.
<b>FUSE, IGNITER, tubular, metal clad</b>	Article consisting of a metal tube with a core of deflagrating explosive.
<b>FUSE, INSTANTANEOUS, NON DETONATING (QUICKMATCH)</b>	Article consisting of cotton yarns impregnated with fine black powder (Quickmatch). It burns with an external flame and is used in ignition trains for fireworks, etc.
<b>FUSE, SAFETY</b>	Article consisting of a core of fine-grained black powder surrounded by a flexible woven fabric with one or more protective outer coverings. When ignited, it burns at a predetermined rate without any external explosive effect.



<b>Fuzes</b>	<p>Articles designed to start a detonation or a deflagration in ammunition. They incorporate mechanical, electrical, chemical or hydrostatic components and generally protective features. The term includes:</p> <p style="padding-left: 20px;">FUZES, DETONATING;  FUZES, DETONATING with protective features;  FUZES, IGNITING.</p>
<b>GRENADES, hand or rifle</b>	<p>Articles which are designed to be thrown by hand or to be projected by a rifle. The term includes:</p> <p style="padding-left: 20px;">GRENADES, hand or rifle, with bursting charge;  GRENADES, PRACTICE, hand or rifle.</p> <p>The term excludes grenades, smoke which are listed under AMMUNITION, SMOKE.</p>
<b>IGNITERS</b>	<p>Articles containing one or more explosive substances used to start deflagration in an explosive train. They may be actuated chemically, electrically or mechanically. This term excludes the following articles which are listed separately: CORD, IGNITER; FUSE, IGNITER; FUSE, NON DETONATING; FUZES, IGNITING; LIGHTERS, FUSE; PRIMERS, CAP TYPE; PRIMERS, TUBULAR.</p>
<b>Ignition, means of</b>	<p>A general term used in connection with the method employed to ignite a deflagrating train of explosive or pyrotechnic substances (for example: a primer for a propelling charge; an igniter for a rocket motor; an igniting fuze).</p>
<b>Initiation, means of</b>	<ol style="list-style-type: none"> <li>(1) A device intended to cause the detonation of an explosive (for example: detonator; detonator for ammunition; detonating fuze).</li> <li>(2) The term “with its own means of initiation” means that the contrivance has its normal initiating device assembled to it and this device is considered to present a significant risk during transport but not one great enough to be unacceptable. The term does not apply, however, to a contrivance packed together with its means of initiation provided the device is packaged so as to eliminate the risk of causing detonation of the contrivance in the event of accidental functioning of the initiating device. The means of initiating can even be assembled to the contrivance provided there are protective features such that the device is very unlikely to cause detonation of the contrivance in conditions which are associated with transport.</li> <li>(3) For the purposes of classification any means of initiation without two effective protective features shall be regarded as Compatibility Group B; an article with its own means of initiation, without two effective protective features, would be Compatibility Group F. On the other hand a means of initiation which itself possesses two effective protective features would be Compatibility Group D; and an article with a means of initiation which possesses two effective protective features would be Compatibility Group D or E. Means of initiation adjudged as having two effective protective features shall have been approved by the competent national authority. A common and effective way of achieving the necessary degree of protection is to use a means of initiation which incorporates two or more independent safety features.</li> </ol>

Appendices

---

JET PERFORATING GUNS, CHARGED, oil well, without detonator	Articles consisting of a steel tube or metallic strip, into which are inserted shaped charges connected by detonating cord, without means of initiation.
LIGHTERS, FUSE	Articles of various design actuated by friction, percussion or electricity and used to ignite safety fuse.
Mass explosion	Explosion which affects almost the entire load virtually instantaneously.
MINES	Articles consisting normally of metal or composition receptacles and a bursting charge. They are designed to be operated by the passage of ships, vehicles or personnel. The term includes "Bangalore torpedoes".
OXYGEN GENERATORS, CHEMICAL	Oxygen generators, chemical, are devices containing chemicals which upon activation releases oxygen as a product of chemical reaction. Chemical oxygen generators are used for the generation of oxygen for respiratory support, e.g. in aircraft, submarines, spacecraft, bomb shelters and breathing apparatus. Oxidizing salts such as chlorates and perchlorates of lithium, sodium and potassium, which are used in chemical oxygen generators, evolve oxygen when heated. These salts are mixed (compounded) with a fuel, usually iron powder, to form a chlorate candle, which produces oxygen by continuous reaction. The fuel is used to generate heat by oxidation. Once the reaction begins, oxygen is released from the hot salt by thermal decomposition (a thermal shield is used around the generator). A portion of the oxygen reacts with the fuel to produce more heat which produces more oxygen, and so on. Initiation of the reaction can be achieved by a percussion device, friction device or electric wire.
POWDER CAKE (POWDER PASTE), WETTED	Substance consisting of nitrocellulose impregnated with not more than 60% of nitroglycerin or other liquid organic nitrates or a mixture of these.
POWDER, SMOKELESS	Substance based on nitrocellulose used as propellant. The term includes propellants with a single base (nitrocellulose (NC) alone), those with a double base (such as NC and nitroglycerin (NG)) and those with a triple base (such as NC/NG/nitroguanidine). Cast, pressed or bag charges of smokeless powder are listed under "CHARGES, PROPELLING" or "CHARGES, PROPELLING FOR CANNON".
PRIMERS, CAP TYPE	Articles consisting of a metal or plastics cap containing a small amount of primary explosive mixture that is readily ignited by impact. They serve as igniting elements in small arms cartridges, and in percussion primers for propelling charges.
PRIMERS, TUBULAR	Articles consisting of a primer for ignition and an auxiliary charge of deflagrating explosive such as black powder used to ignite the propelling charge in a cartridge case for cannon, etc.
PROJECTILES	Articles such as a shell or bullet which are projected from a cannon or other artillery gun, rifle or other small arm. They may be inert, with or without tracer, or may contain a burster or expelling charge or a bursting charge. The term includes: PROJECTILES, inert, with tracer; PROJECTILES with burster or expelling charge; PROJECTILES with bursting charge.

<b>PROPELLANTS</b>	Deflagrating explosive used for propulsion or for reducing the drag of projectiles.
<b>PROPELLANTS, LIQUID</b>	Substances consisting of a deflagrating liquid explosive, used for propulsion.
<b>PROPELLANTS, SOLID</b>	Substances consisting of a deflagrating solid explosive, used for propulsion.
<b>RELEASE DEVICES, EXPLOSIVE</b>	Articles consisting of a small charge of explosive with means of initiation. They sever rods or links to release equipment quickly.
<b>ROCKET MOTORS</b>	Articles consisting of a solid, liquid or hypergolic fuel contained in a cylinder fitted with one or more nozzles. They are designed to propel a rocket or a guided missile. The term includes: ROCKET MOTORS; ROCKET MOTORS WITH HYPERGOLIC LIQUIDS with or without expelling charge; ROCKET MOTORS, LIQUID FUELLED.
<b>ROCKETS</b>	Articles consisting of a rocket motor and a payload which may be an explosive warhead or other device. The term includes guided missiles and: ROCKETS, LINE THROWING; ROCKETS, LIQUID FUELLED with bursting charge; ROCKETS with bursting charge; ROCKETS with expelling charge; ROCKETS with inert head.
<b>SIGNALS</b>	Articles containing pyrotechnic substances designed to produce signals by means of sound, flame or smoke or any combinations thereof. The term includes: SIGNAL DEVICES, HAND; SIGNALS, DISTRESS, ship; SIGNALS, RAILWAY TRACK, EXPLOSIVE; SIGNALS, SMOKE.
<b>SOUNDING DEVICES, EXPLOSIVE</b>	Articles consisting of a charge of detonating explosive. They are dropped from ships and function when they reach a predetermined depth or the sea bed.
<b>STABILIZED</b>	Stabilized means that the substance is in a condition that precludes uncontrolled reaction. This may be achieved by methods such as the addition of an inhibiting chemical, degassing the substance to remove dissolved oxygen and inerting the air space in the package, or maintaining the substance under temperature control.
<b>SUBSTANCES, EXPLOSIVE, VERY INSENSITIVE (SUBSTANCES, EVI), N.O.S.</b>	Substances which present a mass explosion hazard but which are so insensitive that there is very little probability of initiation, or of transition from burning to detonation (under normal conditions of transport) and which have passed Test Series 5.
<b>TORPEDOES</b>	Articles containing an explosive or non explosive propulsion system and designed to be propelled through water. They may contain an inert head or a warhead. The term includes: TORPEDOES, LIQUID FUELLED with inert head; TORPEDOES, LIQUID FUELLED with or without bursting charge; TORPEDOES with bursting charge.

Appendices

---

**TRACERS FOR AMMUNITION**

Sealed articles containing pyrotechnic substances, designed to reveal the trajectory of a projectile.

**Warheads**

Articles consisting of detonating explosives. They are designed to be fitted to a rocket, guided missile or torpedo. They may contain a burster or expelling charge or bursting charge. The term includes:

WARHEADS, ROCKET with burster or expelling charge;

WARHEADS, ROCKET with bursting charge;

WARHEADS, TORPEDO with bursting charge.



# **PART 4**

## PACKING AND TANK PROVISIONS



## Chapter 4.1

### *Use of packagings, including intermediate bulk containers (IBCs) and large packagings*

#### 4.1.0 Definitions

*Effectively closed:* liquid-tight closure.

*Hermetically sealed:* vapour-tight closure.

*Securely closed:* so closed that dry contents cannot escape during normal handling; the minimum provisions for any closure.

#### 4.1.1 General provisions for the packing of dangerous goods in packagings, including IBCs and large packagings

**Note:** For the packing of goods of classes 2, 6.2 and 7, the general provisions of this section only apply as indicated in 4.1.8.2 (class 6.2), 4.1.9.1.5 (class 7) and in the applicable packing instructions of 4.1.4 (P201 and LP02 for class 2 and P620, P621, P650, IBC620 and LP621 for class 6.2).

4.1.1.1 Dangerous goods shall be packed in good quality packagings, including IBCs and large packagings, which shall be strong enough to withstand the shocks and loadings normally encountered during transport, including trans-shipment between cargo transport units and between cargo transport units and warehouses as well as any removal from a pallet or overpack for subsequent manual or mechanical handling. Packagings, including IBCs and large packagings, shall be constructed and closed so as to prevent any loss of contents when prepared for transport which may be caused under normal conditions of transport, by vibration, or by changes in temperature, humidity or pressure (resulting from altitude, for example). Packagings, including IBCs and large packagings, shall be closed in accordance with the information provided by the manufacturer. No dangerous residue shall adhere to the outside of packages, IBCs and large packagings during transport. These provisions apply, as appropriate, to new, re-used, reconditioned or remanufactured packagings, and to new, re-used, repaired or remanufactured IBCs, and to new, re-used or remanufactured large packagings.

4.1.1.2 Parts of packagings, including IBCs and large packagings, which are in direct contact with dangerous goods:

- .1 shall not be affected or significantly weakened by those dangerous goods; and
- .2 shall not cause a dangerous effect, such as catalysing a reaction or reacting with the dangerous goods;
- .3 shall not allow permeation of the dangerous goods that could constitute a danger under normal conditions of transport.

Where necessary, they shall be provided with a suitable inner coating or treatment.

4.1.1.3 Unless otherwise provided elsewhere in this Code, each packaging, including IBCs and large packagings, except inner packagings, shall conform to a design type successfully tested in accordance with the provisions of 6.1.5, 6.3.2, 6.5.4 or 6.6.5, as applicable. However, IBCs manufactured before 1 January 2011 and conforming to a design type which has not passed the vibration test of 6.5.6.13 or which was not required to meet the criteria of 6.5.6.9.5.4 at the time it was subjected to the drop test may still be used.

4.1.1.4 When filling packagings, including IBCs and large packagings, with liquids,<sup>\*</sup> sufficient ullage (outage) shall be left to ensure that neither leakage nor permanent distortion of the packaging occurs as a result of an expansion of the liquid caused by temperatures likely to occur during transport. Unless specific provisions are prescribed, liquids shall not completely fill a packaging at a temperature of 55°C. However, sufficient ullage

<sup>\*</sup> With respect to ullage limits only, the provisions applicable for packagings for solid substances may be used if the viscous substance has an outflow time via a DIN-cup with a 4 mm diameter outlet exceeding 10 minutes at 20°C (corresponding to an outflow time via a Ford cup 4 of more than 690 seconds at 20°C, or to a viscosity of more than 2680 centistokes at 20°C).

## Part 4 – Packing and tank provisions

shall be left in an IBC to ensure that at the mean bulk temperature of 50°C it is not filled to more than 98% of its water capacity.\*

- 4.1.1.4.1 For air transport, packagings intended to contain liquids shall also be capable of withstanding a pressure differential without leakage as specified in the international regulations for air transport.
- 4.1.1.5 Inner packagings shall be packed in an outer packaging in such a way that, under normal conditions of transport, they cannot break, be punctured or leak their contents into the outer packaging. Inner packagings containing liquids shall be packaged with their closures upward and placed within outer packagings consistent with the orientation markings prescribed in 5.2.1.7 of this Code. Inner packagings that are liable to break or be punctured easily, such as those made of glass, porcelain or stoneware or of certain plastics materials, etc., shall be secured in outer packagings with suitable cushioning material. Any leakage of the contents shall not substantially impair the protective properties of the cushioning material or of the outer packaging.
- 4.1.1.5.1 Where an outer packaging of a combination packaging or a large packaging has been successfully tested with different types of inner packagings, a variety of such different inner packagings may also be assembled in this outer packaging or large packagings. In addition, provided an equivalent level of performance is maintained, the following variations in inner packagings are allowed without further testing of the package:
- .1 Inner packagings of equivalent or smaller size may be used provided:
    - the inner packagings are of similar design to the tested inner packagings (such as shape – round, rectangular, etc.);
    - the material of construction of inner packagings (glass, plastics, metal, etc.) offers resistance to impact and stacking forces equal to or greater than that of the originally tested inner packaging;
    - the inner packagings have the same or smaller openings and the closure is of similar design (such as screw cap, friction lid, etc.);
    - sufficient additional cushioning material is used to take up void spaces and to prevent significant movement of the inner packagings;
    - inner packagings are oriented within the outer packaging in the same manner as in the tested package; and
  - .2 A lesser number of the tested inner packagings or of the alternative types of inner packagings identified in .1 above may be used, provided sufficient cushioning is added to fill the void space(s) and to prevent significant movement of the inner packagings.
- 4.1.1.5.2 Cushioning and absorbent material shall be inert and suited to the nature of the contents.
- 4.1.1.5.3 The nature and the thickness of the outer packagings shall be such that friction during transport does not generate any heating likely to alter dangerously the chemical stability of the contents.
- 4.1.1.6 Dangerous goods shall not be packed together in the same outer packaging, or in large packagings, with dangerous or other goods if they react dangerously with each other and cause:
- .1 combustion and/or evolution of considerable heat;
  - .2 evolution of flammable, toxic or asphyxiant gases;
  - .3 the formation of corrosive substances; or
  - .4 the formation of unstable substances.
- 4.1.1.7 The closures of packagings containing wetted or diluted substances shall be such that the percentage of liquid (water, solvent or phlegmatizer) does not fall below the prescribed limits during transport.
- 4.1.1.7.1 Where two or more closure systems are fitted in series on an IBC, that nearest to the substance being transported shall be closed first.
- 4.1.1.7.2 Unless otherwise specified in the Dangerous Goods List, packages containing substances which:
- .1 evolve flammable gases or vapour;
  - .2 may become explosive if allowed to dry;
  - .3 evolve toxic gases or vapour;

\* For a differing temperature, the maximum degree of filling may be determined as follows:

$$\text{Degree of filling} = \frac{98}{1 + \alpha (50 - t_f)} \text{ per cent of the capacity of the IBC}$$

In this formula  $\alpha$  represents the mean coefficient of cubic expansion of the liquid substance between 15°C and 50°C; that is to say, for a maximum rise in the temperature of 35°C, " $\alpha$ " is calculated according to the formula:

$$\alpha = \frac{d_{15} - d_{50}}{35 \times d_{50}}$$

where  $d_{15}$  and  $d_{50}$  are the relative densities of the liquid at 15°C and 50°C and  $t_f$  is the mean temperature of the liquid at the time of filling.



- .4 evolve corrosive gases or vapour; or
  - .5 may react dangerously with the atmosphere
- should be hermetically sealed.

**4.1.1.8** Where pressure may develop in a package by the emission of gas from the contents (as a result of temperature increase or other causes), the packaging or IBC may be fitted with a vent provided that the gas emitted will not cause danger on account of its toxicity, its flammability, the quantity released, etc.

A venting device shall be fitted if dangerous overpressure may develop due to normal decomposition of substances. The vent shall be so designed that, when the packaging or IBC is in the attitude in which it is intended to be transported, leakages of liquid and the penetration of foreign substances are prevented under normal conditions of transport.

**4.1.1.8.1** Liquids may only be filled into inner packagings which have an appropriate resistance to internal pressure that may be developed under normal conditions of transport.

**4.1.1.9** New, remanufactured or re-used packagings, including IBCs and large packagings, or reconditioned packagings and repaired or routinely maintained IBCs shall be capable of passing the tests prescribed in 6.1.5, 6.3.5, 6.5.6 or 6.6.5, as applicable. Before being filled and handed over for transport, every packaging, including IBCs and large packagings, shall be inspected to ensure that it is free from corrosion, contamination or other damage and every IBC shall be inspected with regard to the proper functioning of any service equipment. Any packaging which shows signs of reduced strength as compared with the approved design type shall no longer be used or shall be so reconditioned that it is able to withstand the design type tests. Any IBC which shows signs of reduced strength as compared with the tested design type shall no longer be used or shall be so repaired or routinely maintained that it is able to withstand the design type tests.

**4.1.1.10** Liquids shall be filled only into packagings, including IBCs, which have an appropriate resistance to the internal pressure that may develop under normal conditions of transport. As the vapour pressure of low-boiling-point liquids is usually high, the strength of receptacles for these liquids shall be sufficient to withstand, with an ample factor of safety, the internal pressure likely to be generated. Packagings and IBCs marked with the hydraulic test pressure prescribed in 6.1.3.1(d) and 6.5.2.2.1, respectively, shall be filled only with a liquid having a vapour pressure:

- .1 such that the total gauge pressure in the packaging or IBC (i.e. the vapour pressure of the filling substance plus the partial pressure of air or other inert gases, less 100 kPa) at 55°C, determined on the basis of a maximum degree of filling in accordance with 4.1.1.4 and a filling temperature of 15°C, will not exceed two thirds of the marked test pressure; or
- .2 at 50°C, less than four sevenths of the sum of the marked test pressure plus 100 kPa; or
- .3 at 55°C, less than two thirds of the sum of the marked test pressure plus 100 kPa.

IBCs intended for the transport of liquids shall not be used to carry liquids having a vapour pressure of more than 110 kPa (1.1 bar) at 50°C or 130 kPa (1.3 bar) at 55°C.

**Examples of required marked test pressures for packagings, including IBCs,  
calculated as in 4.1.1.10.3**

UN No.	Name	Class	Packing group	$Vp_{55}$ (kPa)	$Vp_{55} \times 1.5$ (kPa)	$(Vp_{55} \times 1.5)$ minus 100 (kPa)	Required minimum test pressure (gauge) under 6.1.5.5.4.3 (kPa)	Minimum test pressure (gauge) to be marked on the packaging (kPa)
2056	Tetrahydrofuran	3	I	70	105	5	100	100
2247	<i>n</i> -Decane	3	II	1.4	2.1	-97.9	100	100
1593	Dichloromethane	6.1	III	164	246	146	146	150
1155	Diethyl ether	3	I	199	299	199	199	250

**Note 1:** For pure liquids, the vapour pressure at 55°C ( $Vp_{55}$ ) can often be obtained from scientific tables.

**Note 2:** The table refers to the use of 4.1.1.10.3 only, which means that the marked test pressure shall exceed 1.5 times the vapour pressure at 55°C less 100 kPa. When, for example, the test pressure for *n*-decane is determined according to 6.1.5.5.4.1, the minimum marked test pressure may be lower.

**Note 3:** For diethyl ether, the required minimum test pressure under 6.1.5.5.5 is 250 kPa.

**4.1.1.11** Empty packagings, including IBCs and large packagings, that have contained a dangerous substance shall be treated in the same manner as is required by this Code for a filled packaging, unless adequate measures have been taken to nullify any hazard.

## Part 4 – Packing and tank provisions

4.1.1.12 Every packaging, as specified in chapter 6.1, intended to contain liquids shall successfully undergo a suitable leakproofness test, and be capable of meeting the appropriate test level indicated in 6.1.5.4.4:

- .1 before it is first used for transport;
- .2 after remanufacturing or reconditioning of any packaging, before it is re-used for transport.

For this test, the packaging need not have its closures fitted. The inner receptacle of a composite packaging may be tested without the outer packaging, provided the test results are not affected. This test is not necessary for inner packagings of combination packagings or large packagings.

4.1.1.13 Packagings, including IBCs, used for solids which may become liquid at temperatures likely to be encountered during transport shall also be capable of containing the substance in the liquid state.

4.1.1.14 Packagings, including IBCs, used for powdery or granular substances shall be sift-proof or shall be provided with a liner.

4.1.1.15 For plastics drums and jerricans, rigid plastics IBCs and composite IBCs with plastics inner receptacles, unless otherwise approved by the competent authority, the period of use permitted for the transport of dangerous substances shall be five years from the date of manufacture of the receptacles, except where a shorter period of use is prescribed because of the nature of the substance to be transported.

4.1.1.16 Where ice is used as a coolant it shall not affect the integrity of the packaging.

#### 4.1.1.17 Explosives, self-reactive substances and organic peroxides

Unless specific provision to the contrary is made in this Code, the packagings, including IBCs and large packagings, used for goods of class 1, self-reactive substances of class 4.1 and organic peroxides of class 5.2 shall comply with the provisions for the medium danger group (packing group II).

#### 4.1.1.18 Use of salvage packagings

4.1.1.18.1 Damaged, defective, leaking or non-conforming packages, or dangerous goods that have spilled or leaked may be transported in salvage packagings mentioned in 6.1.5.1.11. This does not prevent the use of a bigger size packaging of appropriate type and performance level under the conditions of 4.1.1.18.2.

4.1.1.18.2 Appropriate measures shall be taken to prevent excessive movement of the damaged or leaking packages within a salvage packaging. When the salvage packaging contains liquids, sufficient inert absorbent material shall be added to eliminate the presence of free liquid.

4.1.1.18.3 Appropriate measures shall be taken to ensure there is no dangerous build-up of pressure.

4.1.1.18.4 In addition to the general provisions of the Code, the following paragraphs apply specifically to salvage packagings: 5.2.1.3, 5.4.1.5.3, 6.1.2.4, 6.1.5.1.11 and 6.1.5.7.

#### 4.1.1.19 Use of salvage pressure receptacles

4.1.1.19.1 In the case of damaged, defective, leaking or non-conforming pressure receptacles, salvage pressure receptacles according to 6.2.3 may be used.

**Note:** A salvage pressure receptacle may be used as an overpack in accordance with 5.1.2. When used as an overpack, markings shall be in accordance with 5.1.2.1 instead of 5.2.1.3.

4.1.1.19.2 Pressure receptacles shall be placed in salvage pressure receptacles of suitable size. More than one pressure receptacle may be placed in the same salvage pressure receptacle only if the contents are known and do not react dangerously with each other (see 4.1.1.6). Measures shall be taken to prevent movement of the pressure receptacles within the salvage pressure receptacle, e.g., by partitioning, securing or cushioning.

4.1.1.19.3 A pressure receptacle may only be placed in a salvage pressure receptacle if:

- .1 The salvage pressure receptacle is in accordance with 6.2.3.5 and a copy of the approval certificate is available;
- .2 Parts of the salvage pressure receptacle which are, or are likely to be in direct contact with the dangerous goods will not be affected or weakened by those dangerous goods and will not cause a dangerous effect (e.g., catalyzing reaction or reacting with the dangerous goods); and
- .3 The contents of the contained pressure receptacle(s) is limited in pressure and volume so that if totally discharged into the salvage pressure receptacle, the pressure in the salvage pressure receptacle at 65°C will not exceed the test pressure of the salvage pressure receptacle (for gases, see packing instruction in P200 (3) 4.1.4.1). The reduction of the useable water capacity of the salvage pressure receptacle, e.g., by any contained equipment and cushioning, shall be taken into account.

- 4.1.1.19.4 The proper shipping name, the UN Number preceded by the letters "UN" and label(s) as required for packages in Chapter 5.2 applicable to the dangerous goods inside the contained pressure receptacle(s) shall be applied to the salvage pressure receptacle for transport.
- 4.1.1.19.5 Salvage pressure receptacles shall be cleaned, purged and visually inspected internally and externally after each use. They shall be periodically inspected and tested in accordance with 6.2.1.6 at least once every five years.
- 4.1.1.20 During transport, packagings, including IBCs and large packagings, shall be securely fastened to or contained within the cargo transport unit, so that lateral or longitudinal movement or impact is prevented and adequate external support is provided.

## 4.1.2 Additional general provisions for the use of IBCs

- 4.1.2.1 When IBCs are used for the transport of liquids with a flashpoint of 60°C (closed cup) or lower, or of powders liable to dust explosion, measures shall be taken to prevent a dangerous electrostatic discharge.
- 4.1.2.2.1 Every metal, rigid plastics and composite IBC shall be inspected and tested, as relevant, in accordance with 6.5.4.4 or 6.5.4.5:
  - .1 before it is put into service;
  - .2 thereafter at intervals not exceeding two and a half and five years, as appropriate; and
  - .3 after the repair or remanufacture, before it is re-used for transport.
- 4.1.2.2.2 An IBC shall not be filled and offered for transport after the date of expiry of the last periodic test or inspection. However, an IBC filled prior to the date of expiry of the last periodic test or inspection may be transported for a period not to exceed three months beyond the date of expiry of the last periodic test or inspection. In addition, an IBC may be transported after the date of expiry of the last periodic test or inspection:
  - .1 after emptying but before cleaning, for purposes of performing the required test or inspection prior to refilling; and
  - .2 unless otherwise approved by the competent authority, for a period not to exceed six months beyond the date of expiry of the last periodic test or inspection in order to allow the return of dangerous goods or residues for proper disposal or recycling. Reference to this exemption shall be entered in the transport document.
- 4.1.2.3 IBCs of type 31HZ2 when transporting liquids shall be filled to at least 80% of the volume of the outer casing and shall be transported in closed cargo transport units.
- 4.1.2.4 Except for routine maintenance of metal, rigid plastics, composite and flexible IBCs performed by the owner of the IBC, whose State and name or authorized symbol is durably marked on the IBC, the party performing routine maintenance shall durably mark the IBC near the manufacturer's UN design type marking to show:
  - .1 the State in which the routine maintenance was carried out; and
  - .2 the name or authorized symbol of the party performing the routine maintenance.

## 4.1.3 General provisions concerning packing instructions

- 4.1.3.1 Packing instructions applicable to dangerous goods of classes 1 to 9 are specified in 4.1.4. They are subdivided in three sub-sections depending on the type of packagings to which they apply:
  - sub-section 4.1.4.1 for packagings other than IBCs and large packagings; these packing instructions are designated by an alphanumeric code comprising the letter "P";
  - sub-section 4.1.4.2 for IBCs; these are designated by an alphanumeric code comprising the letters "IBC";
  - sub-section 4.1.4.3 for large packagings; these are designated by an alphanumeric code comprising the letters "LP".

Generally, packing instructions specify that the general provisions of 4.1.1, 4.1.2 and/or 4.1.3, as appropriate, are applicable. They may also require compliance with the special provisions of 4.1.5, 4.1.6, 4.1.7, 4.1.8 or 4.1.9 when appropriate. Special packing provisions may also be specified in the packing instruction for individual substances or articles. They are also designated by an alphanumeric code comprising the letters:

- "PP" for packagings other than IBCs and large packagings
- "B" for IBCs
- "L" for large packagings.

Unless otherwise specified, each packaging shall conform to the applicable provisions of part 6. Generally, packing instructions do not provide guidance on compatibility and the user shall not select a packaging

## Part 4 – Packing and tank provisions

without checking that the substance is compatible with the packaging material selected (such as, most fluorides are unsuitable for glass receptacles). Where glass receptacles are permitted in the packing instructions, porcelain, earthenware and stoneware packagings are also allowed.

4.1.3.2 Column 8 of the Dangerous Goods List shows for each article or substance the packing instruction(s) that shall be used. Column 9 indicates the special packing provisions applicable to specific substances or articles.

4.1.3.3 Each packing instruction shows, where applicable, the acceptable single and combination packagings. For combination packagings, the acceptable outer packagings, inner packagings and, when applicable, the maximum quantity permitted in each inner or outer packaging are shown. *Maximum net mass* and *maximum capacity* are as defined in 1.2.1.

4.1.3.4 The following packagings shall not be used when the substances being transported are liable to become liquid during transport:

**Packagings**

Drums: 1D and 1G

Boxes: 4C1, 4C2, 4D, 4F, 4G and 4H1

Bags: 5L1, 5L2, 5L3, 5H1, 5H2, 5H3, 5H4, 5M1 and 5M2

Composite: 6HC, 6HD1, 6HD2, 6HG1, 6HG2, 6PC, 6PD1, 6PD2, 6PG1, 6PG2 and 6PH1

**Large packagings**

Flexible plastics: 51H (outer packaging)

**IBCs**

For substances of packing group I:

All types of IBCs

For substances of packing groups II and III:

Wooden: 11C, 11D and 11F

Fibreboard: 11G

Flexible: 13H1, 13H2, 13H3, 13H4, 13H5, 13L1, 13L2, 13L3, 13L4, 13M1 and 13M2

Composite: 11HZ2 and 21HZ2

4.1.3.5 Where the packing instructions in this chapter authorize the use of a particular type of packaging (such as 4G; 1A2), packagings bearing the same packaging identification code followed by the letters “V”, “U” or “W” marked in accordance with the provisions of part 6 (such as “4GV”, “4GU” or “4GW”; “1A2V”, “1A2U” or “1A2W”) may also be used under the same conditions and limitations applicable to the use of that type of packaging according to the relevant packing instructions. For example, a combination packaging marked with the packaging code “4GV” may be used whenever a combination packaging marked “4G” is authorized, provided the provisions in the relevant packing instruction regarding types of inner packagings and quantity limitations are respected.

**4.1.3.6 Pressure receptacles for liquids and solids**

4.1.3.6.1 Unless otherwise indicated in this Code, pressure receptacles conforming to:

- (a) the applicable requirements of chapter 6.2; or
- (b) the National or International standards on the design, construction, testing, manufacturing and inspection, as applied by the country in which the pressure receptacles are manufactured, provided that the provisions of 4.1.3.6 and 6.2.3.3 are met,

are authorized for the transport of any liquid or solid substance other than explosives, thermally unstable substances, organic peroxides, self-reactive substances, substances where significant pressure may develop by evolution of chemical reaction and radioactive material (unless permitted in 4.1.9).

This sub-section is not applicable to the substances mentioned in 4.1.4.1, packing instruction P200, table 3.

4.1.3.6.2 Every design type of pressure receptacle shall be approved by the competent authority of the country of manufacture or as indicated in chapter 6.2.

4.1.3.6.3 Unless otherwise indicated, pressure receptacles having a minimum test pressure of 0.6 MPa shall be used.

4.1.3.6.4 Unless otherwise indicated, pressure receptacles may be provided with an emergency pressure relief device designed to avoid bursting in case of overfill or fire accidents.

Pressure receptacle valves shall be designed and constructed in such a way that they are inherently able to withstand damage without release of the contents or shall be protected from damage which could cause inadvertent release of the contents of the pressure receptacle, by one of the methods as given in 4.1.6.1.8 (.1) to (.5).

- 4.1.3.6.5** The level of filling shall not exceed 95% of the capacity of the pressure receptacle at 50°C. Sufficient ullage (outage) shall be left to ensure that the pressure receptacle will not be liquid-full at a temperature of 55°C.
- 4.1.3.6.6** Unless otherwise indicated, pressure receptacles shall be subjected to a periodic inspection and test every 5 years. The periodic inspection shall include an external examination, an internal examination or alternative method as approved by the competent authority, a pressure test or equivalent effective non-destructive testing with the agreement of the competent authority, including an inspection of all accessories (e.g., tightness of valves, emergency relief valves or fusible elements). Pressure receptacles shall not be filled after they become due for periodic inspection and test but may be transported after the expiry of the time limit. Pressure receptacle repairs shall meet the requirements of 4.1.6.1.11.
- 4.1.3.6.7** Prior to filling, the filler shall perform an inspection of the pressure receptacle and ensure that the pressure receptacle is authorized for the substances to be transported and that the provisions of this Code have been met. Shut-off valves shall be closed after filling and remain closed during transport. The consignor shall verify that the closures and equipment are not leaking.
- 4.1.3.6.8** Refillable pressure receptacles shall not be filled with a substance different from that previously contained unless the necessary operations for change of service have been performed.
- 4.1.3.6.9** Marking of pressure receptacles for liquids and solids according to 4.1.3.6 (not conforming to the requirements of chapter 6.2) shall be in accordance with the requirements of the competent authority of the country of manufacturing.
- 4.1.3.7** Packagings, including IBCs and large packagings, not specifically authorized in the applicable packing instruction shall not be used for the transport of a substance or article unless specifically approved by the competent authority and provided:
- .1 the alternative packaging complies with the general provisions of this chapter;
  - .2 when the packing instruction indicated in the Dangerous Goods List so specifies, the alternative packaging meets the provisions of part 6;
  - .3 the competent authority determines that the alternative packaging provides at least the same level of safety as if the substance were packed in accordance with a method specified in the particular packing instruction indicated in the Dangerous Goods List; and
  - .4 a copy of the competent authority approval accompanies each consignment or the transport document includes an indication that alternative packaging was approved by the competent authority.

**Note:** The competent authorities granting such approvals shall take action to amend the Code to include the provisions covered by the approval as appropriate.

**4.1.3.8 Unpackaged articles other than class 1 articles**

- 4.1.3.8.1** Where large and robust articles cannot be packaged in accordance with the requirements of chapter 6.1 or 6.6 and they have to be transported empty, uncleaned and unpackaged, the competent authority may approve such transport. In doing so, the competent authority shall take into account that:
- .1 Large and robust articles shall be strong enough to withstand the shocks and loadings normally encountered during transport, including trans-shipment between cargo transport units and between cargo transport units and warehouses, as well as any removal from a pallet for subsequent manual or mechanical handling;
  - .2 All closures and openings shall be sealed so that there can be no loss of contents which might be caused under normal conditions of transport, by vibration, or by changes in temperature, humidity or pressure (resulting from altitude, for example). No dangerous residue shall adhere to the outside of the large and robust articles;
  - .3 Parts of large and robust articles, which are in direct contact with dangerous goods:
    - .1 shall not be affected or significantly weakened by those dangerous goods; and
    - .2 shall not cause a dangerous effect, e.g. catalysing a reaction or reacting with the dangerous goods;
  - .4 Large and robust articles containing liquids shall be stowed and secured to ensure that neither leakage nor permanent distortion of the article occurs during transport;
  - .5 They shall be fixed in cradles or crates or other handling devices in such a way that they will not become loose during normal conditions of transport.

Part 4 – Packing and tank provisions

---

4.1.3.8.2 Unpackaged articles approved by the competent authority in accordance with the provisions of 4.1.3.8.1 shall be subject to the consignment procedures of part 5. In addition the consignor of such articles shall ensure that a copy of any such approval is transported with the large and robust articles.

**Note:** A large and robust article may include flexible fuel containment systems, military equipment, machinery or equipment containing dangerous goods above the limited quantity thresholds.

4.1.3.9 Where, in 4.1.3.6 and in the individual packing instructions, cylinders and other pressure receptacles for gases are authorized for the transport of any liquid or solid substance, use is also authorized of cylinders and pressure receptacles of a kind normally used for gases which conform to the requirements of the competent authority of the country in which the cylinder or pressure receptacle is filled. Valves shall be suitably protected. Pressure receptacles with capacities of 1 l or less shall be packed in outer packagings constructed of suitable material of adequate strength and design in relation to the capacity of the packaging and its intended use and secured or cushioned so as to prevent significant movement within the outer packaging during normal conditions of transport.

**4.1.4 List of packing instructions**

**4.1.4.1 Packing instructions concerning the use of packagings (except IBCs and large packagings)**

P001		PACKING INSTRUCTION (LIQUIDS)			P001
The following packagings are authorized provided the general provisions of 4.1.1 and 4.1.3 are met:					
Combination packagings		Maximum capacity/net mass (see 4.1.3.3)			
Inner packagings	Outer packagings	Packing group I	Packing group II	Packing group III	
Glass	10 ℓ	<b>Drums</b>			
Plastics	30 ℓ	steel (1A1, 1A2)	75 kg	400 kg	400 kg
Metal	40 ℓ	aluminium (1B1, 1B2)	75 kg	400 kg	400 kg
		other metal (1N1, 1N2)	75 kg	400 kg	400 kg
		plastics (1H1, 1H2)	75 kg	400 kg	400 kg
		plywood (1D)	75 kg	400 kg	400 kg
		fibre (1G)	75 kg	400 kg	400 kg
		<b>Boxes</b>			
		steel (4A)	75 kg	400 kg	400 kg
		aluminium (4B)	75 kg	400 kg	400 kg
		other metal (4N)	75 kg	400 kg	400 kg
		natural wood (4C1, 4C2)	75 kg	400 kg	400 kg
		plywood (4D)	75 kg	400 kg	400 kg
		reconstituted wood (4F)	75 kg	400 kg	400 kg
		fibreboard (4G)	75 kg	400 kg	400 kg
		expanded plastics (4H1)	40 kg	60 kg	60 kg
		solid plastics (4H2)	75 kg	400 kg	400 kg
		<b>Jerricans</b>			
		steel (3A1, 3A2)	60 kg	120 kg	120 kg
		aluminium (3B1, 3B2)	60 kg	120 kg	120 kg
		plastics (3H1, 3H2)	30 kg	120 kg	120 kg
Single packagings					
<b>Drums</b>					
	steel, non-removable head (1A1)		250 ℓ	450 ℓ	450 ℓ
	steel, removable head (1A2)		prohibited	250 ℓ	250 ℓ
	aluminium, non-removable head (1B1)		250 ℓ	450 ℓ	450 ℓ
	aluminium, removable head (1B2)		prohibited	250 ℓ	250 ℓ
	other metal, non-removable head (1N1)		250 ℓ	450 ℓ	450 ℓ
	other metal, removable head (1N2)		prohibited	250 ℓ	250 ℓ
	plastics, non-removable head (1H1)		250 ℓ*	450 ℓ	450 ℓ
	plastics, removable head (1H2)		prohibited	250 ℓ	250 ℓ
<b>Jerricans</b>					
	steel, non-removable head (3A1)		60 ℓ	60 ℓ	60 ℓ
	steel, removable head (3A2)		prohibited	60 ℓ	60 ℓ
	aluminium, non-removable head (3B1)		60 ℓ	60 ℓ	60 ℓ
	aluminium, removable head (3B2)		prohibited	60 ℓ	60 ℓ
	plastics, non-removable head (3H1)		60 ℓ*	60 ℓ	60 ℓ
	plastics, removable head (3H2)		prohibited	60 ℓ	60 ℓ
<b>Composite packagings</b>					
	Plastics receptacle in steel or aluminium drum (6HA1, 6HB1)		250 ℓ	250 ℓ	250 ℓ
	Plastics receptacle in fibre, plastics or plywood drum (6HG1, 6HH1, 6HD1)		120 ℓ*	250 ℓ	250 ℓ
	Plastics receptacle in steel or aluminium crate or box or plastics receptacle in wood, plywood, fibreboard or solid plastics box (6HA2, 6HB2, 6HC, 6HD2, 6HG2 or 6HH2)		60 ℓ*	60 ℓ	60 ℓ
	Glass receptacle in steel, aluminium, fibre, plywood, solid plastics or expanded plastics drum (6PA1, 6PB1, 6PG1, 6PD1, 6PH1 or 6PH2) or in a steel, aluminium, wood or fibreboard box or in a wickerwork hamper (6PA2, 6PB2, 6PC, 6PG2 or 6PD2)		60 ℓ	60 ℓ	60 ℓ
<b>Pressure receptacles</b> , provided that the general provisions of 4.1.3.6 are met					

\* Not permitted for class 3, packing group I.

Part 4 – Packing and tank provisions

P001	PACKING INSTRUCTION (LIQUIDS) (continued)	P001
<b>Special packing provisions:</b>		
<b>PP1</b>	For UN Nos. 1133, 1210, 1263 and 1866 and for adhesives, printing inks, printing ink related materials, paints, paint related materials and resin solutions which are assigned to UN 3082, metal or plastics packagings for substances of packing groups II and III in quantities of 5 litres or less per packaging are not required to meet the performance tests in chapter 6.1 when transported:	
	(a) in palletized loads, a pallet box or a unit load device, such as individual packagings placed or stacked and secured by strapping, shrink- or stretch-wrapping or other suitable means to a pallet. For sea transport, the palletized loads, pallet boxes or unit load devices shall be firmly packed and secured in closed cargo transport units; or	
	(b) as an inner packaging of a combination packaging with a maximum net mass of 40 kg.	
<b>PP2</b>	For UN 3065, wooden barrels with a maximum capacity of 250 litres and which do not meet the provisions of chapter 6.1 may be used.	
<b>PP4</b>	For UN 1774, packagings shall meet the packing group II performance level.	
<b>PP5</b>	For UN 1204, packagings shall be so constructed that explosion is not possible by reason of increased internal pressure. Gas cylinders and gas receptacles shall not be used for these substances.	
<b>PP10</b>	For UN 1791, for packing group II, the packaging shall be vented.	
<b>PP31</b>	For UN Nos. 1131, 1553, 1693, 1694, 1699, 1701, 2478, 2604, 2785, 3148, 3183, 3184, 3185, 3186, 3187, 3188, 3398 (PG II and III), 3399 (PG II and III), 3413 and 3414, packagings shall be hermetically sealed.	
<b>PP33</b>	For UN 1308, for packing groups I and II, only combination packagings with a maximum gross mass of 75 kg are allowed.	
<b>PP81</b>	For UN 1790 with more than 60% but not more than 85% hydrogen fluoride and UN 2031 with more than 55% nitric acid, the permitted use of plastics drums and jerricans as single packagings shall be two years from their date of manufacture.	

P002	PACKING INSTRUCTION (SOLIDS)					P002
The following packagings are authorized provided the general provisions of 4.1.1 and 4.1.3 are met.						
Combination packagings			Maximum net mass (see 4.1.3.3)			
Inner packagings	Outer packagings		Packing group I	Packing group II	Packing group III	
Glass	10 kg	<b>Drums</b>				
Plastics <sup>1</sup>	30 kg	steel (1A1, 1A2)	125 kg	400 kg	400 kg	
Metal	40 kg	aluminium (1B1, 1B2)	125 kg	400 kg	400 kg	
Paper <sup>1, 2, 3</sup>	50 kg	other metal (1N1, 1N2)	125 kg	400 kg	400 kg	
Fibre <sup>1, 2, 3</sup>	50 kg	plastics (1H1, 1H2)	125 kg	400 kg	400 kg	
		plywood (1D)	125 kg	400 kg	400 kg	
		fibre (1G)	125 kg	400 kg	400 kg	
		<b>Boxes</b>				
		steel (4A)	125 kg	400 kg	400 kg	
		aluminium (4B)	125 kg	400 kg	400 kg	
		other metal (4N)	125 kg	400 kg	400 kg	
		natural wood (4C1)	125 kg	400 kg	400 kg	
		natural wood with sift-proof walls (4C2)	250 kg	400 kg	400 kg	
		plywood (4D)	125 kg	400 kg	400 kg	
		reconstituted wood (4F)	125 kg	400 kg	400 kg	
		fibreboard (4G)	75 kg	400 kg	400 kg	
		expanded plastics (4H1)	40 kg	60 kg	60 kg	
		solid plastics (4H2)	125 kg	400 kg	400 kg	
		<b>Jerricans</b>				
		steel (3A1, 3A2)	75 kg	120 kg	120 kg	
		aluminium (3B1, 3B2)	75 kg	120 kg	120 kg	
		plastics (3H1, 3H2)	75 kg	120 kg	120 kg	
<b>Single packagings</b>						
<b>Drums</b>						
		steel (1A1 or 1A2 <sup>4</sup> )	400 kg	400 kg	400 kg	
		aluminium (1B1 or 1B2 <sup>4</sup> )	400 kg	400 kg	400 kg	
		metal, other than steel or aluminium (1N1 or 1N2 <sup>4</sup> )	400 kg	400 kg	400 kg	
		plastics (1H1 or 1H2 <sup>4</sup> )	400 kg	400 kg	400 kg	
		fibre (1G <sup>5</sup> )	400 kg	400 kg	400 kg	
		plywood (1D <sup>5</sup> )	400 kg	400 kg	400 kg	
<sup>4</sup> These packagings shall not be used for substances of packing group I that may become liquid during transport (see 4.1.3.4).						
<sup>5</sup> These packagings shall not be used when the substances being transported may become liquid during transport (see 4.1.3.4).						



Chapter 4.1 – Use of packagings, including IBCs and large packagings

P002	PACKING INSTRUCTION (SOLIDS) (continued)			P002
The following packagings are authorized provided the general provisions of 4.1.1 and 4.1.3 are met.				
		Maximum net mass (see 4.1.3.3)		
Single packagings (continued)	Packing group I	Packing group II	Packing group III	
<b>Jerricans</b>				
steel (3A1 or 3A2 <sup>4</sup> )	120 kg	120 kg	120 kg	
aluminium (3B1 or 3B2 <sup>4</sup> )	120 kg	120 kg	120 kg	
plastics (3H1 or 3H2 <sup>4</sup> )	120 kg	120 kg	120 kg	
<b>Boxes</b>				
steel (4A) <sup>5</sup>	Not allowed	400 kg	400 kg	
aluminium (4B) <sup>5</sup>	Not allowed	400 kg	400 kg	
other metal (4N) <sup>5</sup>	Not allowed	400 kg	400 kg	
natural wood (4C1) <sup>5</sup>	Not allowed	400 kg	400 kg	
natural wood with sift-proof walls (4C2) <sup>5</sup>	Not allowed	400 kg	400 kg	
plywood (4D) <sup>5</sup>	Not allowed	400 kg	400 kg	
reconstituted wood (4F) <sup>5</sup>	Not allowed	400 kg	400 kg	
fibreboard (4G) <sup>5</sup>	Not allowed	400 kg	400 kg	
solid plastics (4H2) <sup>5</sup>	Not allowed	400 kg	400 kg	
<b>Bags</b>				
bags (5H3, 5H4, 5L3, 5M2) <sup>5</sup>	Not allowed	50 kg	50 kg	
<b>Composite packagings</b>				
Plastics receptacle in steel, aluminium, plywood, fibre or plastics drum (6HA1, 6HB1, 6HG1 <sup>5</sup> , 6HD1 <sup>5</sup> , or 6HH1)	400 kg	400 kg	400 kg	
Plastics receptacle in steel or aluminium crate or box, wooden box, plywood box, fibreboard box or solid plastics box (6HA2, 6HB2, 6HC, 6HD2 <sup>5</sup> , 6HG2 <sup>5</sup> or 6HH2)	75 kg	75 kg	75 kg	
Glass receptacle in steel, aluminium, plywood or fibre drum (6PA1, 6PB1, 6PD1 <sup>5</sup> or 6PG1 <sup>5</sup> ) or in steel, aluminium, wood, or fibreboard box or in wickerwork hamper (6PA2, 6PB2, 6PC, 6PG2 <sup>5</sup> or 6PD2 <sup>5</sup> ) or in solid or expanded plastics packaging (6PH2 or 6PH1 <sup>5</sup> )	75 kg	75 kg	75 kg	
<sup>4</sup> These packagings shall not be used for substances of packing group I that may become liquid during transport (see 4.1.3.4).				
<sup>5</sup> These packagings shall not be used when the substances being transported may become liquid during transport (see 4.1.3.4).				
<b>Pressure receptacles, provided that the general provisions of 4.1.3.6 are met</b>				

## Part 4 – Packing and tank provisions

<i>Special packing provisions:</i>	
PP7	For UN 2000, celluloid may be transported unpacked on pallets, wrapped in plastic film and secured by appropriate means, such as steel bands, as a single commodity in closed cargo transport units. Each pallet shall not exceed 1000 kg.
PP8	For UN 2002, packagings shall be so constructed that explosion is not possible by reason of increased internal pressure. Gas cylinders and gas receptacles shall not be used for these substances.
PP9	For UN 3175, UN 3243 and UN 3244, packagings shall conform to a design type that has passed a leakproofness test at the packing group II performance level. For UN 3175 the leakproofness test is not required when the liquids are fully absorbed in solid material contained in sealed bags.
PP11	For UN 1309, packing group III, and UN 1361 and UN 1362, 5M1 bags are allowed if they are overpacked in plastic bags and are wrapped in shrink or stretch wrap on pallets.
PP12	For UN 1361, UN 2213 and UN 3077, 5H1, 5L1 and 5M1 bags are allowed when transported in closed cargo transport units.
PP13	For articles classified under UN 2870, only combination packagings meeting the packing group I performance level are authorized.
PP14	For UN 2211, UN 2698 and UN 3314, packagings are not required to meet the performance tests in chapter 6.1.
PP15	For UN 1324 and UN 2623, packagings shall meet the packing group III performance level.
PP20	For UN 2217, any sift-proof, tearproof receptacle may be used.
PP30	For UN 2471, paper or fibre inner packagings are not permitted.
PP31	For UN Nos. 1362, 1463, 1565, 1575, 1626, 1680, 1689, 1698, 1868, 1889, 1932, 2471, 2545, 2546, 2881, 3048, 3088, 3170, 3174, 3181, 3182, 3189, 3190, 3205, 3206, 3341, 3342, 3448, 3449 and 3450, packagings shall be hermetically sealed.
PP34	For UN 2969 (as whole beans), 5H1, 5L1 and 5M1 bags are permitted.
PP37	For UN 2590 and UN 2212, 5M1 bags are permitted. All bags of any type shall be transported in closed cargo transport units or be placed in closed rigid overpacks.
PP38	For UN 1309, bags are permitted only in closed cargo transport units or as unit loads.
PP84	For UN 1057, rigid outer packagings meeting the packing group II performance level shall be used. The packagings shall be designed and constructed and arranged to prevent movement, inadvertent ignition of the devices or inadvertent release of flammable gas or liquid.
PP85	For UN Nos. 1748, 2208, 2880, 3485, 3486 and 3487, bags are not allowed.

P003	PACKING INSTRUCTION	P003
Dangerous goods shall be placed in suitable outer packagings. The packagings shall meet the provisions of 4.1.1.1, 4.1.1.2, 4.1.1.4, 4.1.1.8 and 4.1.3 and be so designed that they meet the construction provisions of 6.1.4. Outer packagings constructed of suitable material, and of adequate strength and design in relation to the packaging capacity and its intended use, shall be used. Where this packing instruction is used for the transport of articles or inner packagings of combination packagings, the packaging shall be designed and constructed to prevent inadvertent discharge of articles during normal conditions of transport.		
<i>Special packing provisions:</i>		
PP16 For UN 2800, batteries shall be protected from short circuit within the packagings.		
PP17 For UN Nos. 2037, packages shall not exceed 55 kg net mass for fibreboard packagings or 125 kg net mass for other packagings.		
PP18 For UN 1845, packagings shall be designed and constructed to permit the release of carbon dioxide gas to prevent a build-up of pressure that could rupture the packagings.		
PP19 For UN Nos. 1327, 1364, 1365, 1856 and 3360, transport as bales is authorized.		
PP20 For UN Nos. 1363, 1386, 1408 and 2793, any sift-proof, tearproof receptacle may be used.		
PP32 UN Nos. 2857 and 3358 may be transported unpackaged, in crates or in appropriate overpacks.		
PP90 For UN 3506, sealed inner liners or bags of strong leak-proof and puncture resistant material impervious to mercury which will prevent escape of the substance from the package irrespective of the position of the package shall be used.		

P004	PACKING INSTRUCTION	P004
This instruction applies to UN Nos. 3473, 3476, 3477, 3478 and 3479		

**Chapter 4.1 – Use of packagings, including IBCs and large packagings**

<p>The following packagings are authorized:</p> <p>(1) For fuel cell cartridges, provided that the general provisions of 4.1.1.1, 4.1.1.2, 4.1.1.3, 4.1.1.6 and 4.1.3 are met: Drums (1A2, 1B2, 1N2, 1H2, 1D, 1G); Boxes (4A, 4B, 4N, 4C1, 4C2, 4D, 4F, 4G, 4H1, 4H2); Jerricans (3A2, 3B2, 3H2). Packagings shall conform to the packing group II performance level.</p> <p>(2) For fuel cell cartridges packed with equipment: strong outer packagings which meet the general provisions of 4.1.1.1, 4.1.1.2, 4.1.1.6 and 4.1.3. When fuel cell cartridges are packed with equipment, they shall be packed in inner packagings or placed in the outer packaging with cushioning material or divider(s) so that the fuel cell cartridges are protected against damage that may be caused by the movement or placement of the contents within the outer packaging. The equipment shall be secured against movement within the outer packaging. For the purpose of this packing instruction, "equipment" means apparatus requiring the fuel cell cartridges with which it is packed for its operation.</p> <p>(3) For fuel cell cartridges contained in equipment: strong outer packagings which meet the general provisions of 4.1.1.1, 4.1.1.2, 4.1.1.6 and 4.1.3. Large robust equipment (see 4.1.3.8) containing fuel cell cartridges may be transported unpackaged. For fuel cell cartridges contained in equipment, the entire system shall be protected against short circuit and inadvertent operation.</p>
--

P010		PACKING INSTRUCTION		P010
The following packagings are authorized, provided that the general provisions of 4.1.1 and 4.1.3 are met.				
Combination packagings			Maximum net mass (see 4.1.3.3)	
Inner packagings	Outer packagings			
Glass 1 ℓ Steel 40 ℓ	<b>Drums</b> steel (1A1, 1A2) 400 kg plastics (1H1, 1H2) 400 kg plywood (1D) 400 kg fibre (1G) 400 kg <b>Boxes</b> steel (4A) 400 kg natural wood (4C1, 4C2) 400 kg plywood (4D) 400 kg reconstituted wood (4F) 400 kg fibreboard (4G) 400 kg expanded plastics (4H1) 60 kg solid plastics (4H2) 400 kg			
Single packagings			Maximum capacity (see 4.1.3.3)	
<b>Drums</b> steel, non-removable head (1A1) 450 ℓ <b>Jerricans</b> steel, non-removable head (3A1) 60 ℓ <b>Composite packagings</b> plastics receptacle in steel drums (6HA1) 250 ℓ <b>Steel pressure receptacles</b> provided that the general provisions of 4.1.3.6 are met.				

Part 4 – Packing and tank provisions

P099	PACKING INSTRUCTION	P099
<p>Only packagings which are approved for these goods by the competent authority may be used (see 4.1.3.7). A copy of the competent authority approval shall accompany each consignment or the transport document shall include an indication that the packaging was approved by the competent authority.</p>		

P101	PACKING INSTRUCTION	P101
<p>Only packagings which are approved by the competent authority may be used. The State's distinguishing sign for motor vehicles in international traffic of the country for which the authority acts shall be marked on the transport documents as follows: "Packaging approved by the competent authority of ..."</p>		

P110(a)	PACKING INSTRUCTION	P110(a)
<p>The following packagings are authorized, provided the general packing provisions of 4.1.1, 4.1.3 and special packing provisions of 4.1.5 are met.</p>		
Inner packagings	Intermediate packagings	Outer packagings
<p><b>Bags</b> plastics textile, plastic coated or lined rubber textile, rubberized textile</p> <p><b>Receptacles</b> wood</p>	<p><b>Bags</b> plastics textile, plastic coated or lined rubber textile, rubberized</p> <p><b>Receptacles</b> plastics metal wood</p>	<p><b>Drums</b> steel (1A1, 1A2) metal, other than steel or aluminium (1N1, 1N2) plastics (1H1, 1H2)</p>
<p><b>Additional provisions:</b></p> <ol style="list-style-type: none"> <li>The intermediate packagings shall be filled with water-saturated material such as an anti-freeze solution or wetted cushioning.</li> <li>Outer packagings shall be filled with water-saturated material such as an anti-freeze solution or wetted cushioning. Outer packagings shall be constructed and sealed to prevent evaporation of the wetting solution, except for UN 0224 when transported dry.</li> </ol>		

P110(b)	PACKING INSTRUCTION	P110(b)
<p>The following packagings are authorized, provided the general packing provisions of 4.1.1, 4.1.3 and special packing provisions of 4.1.5 are met.</p>		
Inner packagings	Intermediate packagings	Outer packagings
<p><b>Receptacles</b> metal wood rubber, conductive plastics, conductive</p> <p><b>Bags</b> rubber, conductive plastics, conductive</p>	<p><b>Dividing partitions</b> metal wood plastics fibreboard</p>	<p><b>Boxes</b> natural wood, sift-proof wall (4C2) plywood (4D) reconstituted wood (4F)</p>
<p><b>Special packing provisions:</b></p> <p>PP42 For UN Nos. 0074, 0113, 0114, 0129, 0130, 0135 and 0224, the following conditions shall be met:</p> <ol style="list-style-type: none"> <li>inner packagings shall not contain more than 50 g of explosive substance (quantity corresponding to dry substance);</li> <li>compartments between dividing partitions shall not contain more than one inner packaging, firmly fitted; and</li> <li>the outer packaging may be partitioned into up to 25 compartments.</li> </ol>		

Chapter 4.1 – Use of packagings, including IBCs and large packagings

P111 PACKING INSTRUCTION P111		
The following packagings are authorized, provided the general packing provisions of 4.1.1, 4.1.3 and special packing provisions of 4.1.5 are met.		
Inner packagings	Intermediate packagings	Outer packagings
<b>Bags</b> paper, waterproofed plastics textile, rubberized  <b>Sheets</b> plastics textile, rubberized  <b>Receptacles</b> wood	<i>Not necessary</i>	<b>Boxes</b> steel (4A) aluminium (4B) other metal (4N) natural wood, ordinary (4C1) natural wood, sift-proof (4C2) plywood (4D) reconstituted wood (4F) fibreboard (4G) plastics, expanded (4H1) plastics, solid (4H2)  <b>Drums</b> steel (1A1, 1A2) aluminium (1B1, 1B2) other metal (1N1, 1N2) plywood (1D) fibre (1G) plastics (1H1, 1H2)
<b>Special packing provisions:</b> PP43 For UN 0159, inner packagings are not required when metal (1A1, 1A2, 1B1, 1B2, 1N1 or 1N2) or plastics (1H1 or 1H2) drums are used as outer packagings.		

P112(a) PACKING INSTRUCTION P112(a) (Solid wetted, 1.1D)		
The following packagings are authorized, provided the general packing provisions of 4.1.1, 4.1.3 and special packing provisions of 4.1.5 are met.		
Inner packagings	Intermediate packagings	Outer packagings
<b>Bags</b> paper, multiwall, water-resistant plastics textile textile, rubberized woven plastics  <b>Receptacles</b> metal plastics wood	<b>Bags</b> plastics textile, plastic coated or lined  <b>Receptacles</b> metal plastics wood	<b>Boxes</b> steel (4A) aluminium (4B) other metal (4N) natural wood, ordinary (4C1) natural wood, sift-proof (4C2) plywood (4D) reconstituted wood (4F) fibreboard (4G) plastics, expanded (4H1) plastics, solid (4H2)  <b>Drums</b> steel (1A1, 1A2) aluminium (1B1, 1B2) other metal (1N1, 1N2) plywood (1D) fibre (1G) plastics (1H1, 1H2)
<b>Additional provision:</b> Intermediate packagings are not required if leakproof removable head drums are used as the outer packaging.		
<b>Special packing provisions:</b> PP26 For UN Nos. 0004, 0076, 0078, 0154, 0219 and 0394, packagings shall be lead-free. PP45 For UN 0072 and UN 0226, intermediate packagings are not required.		

Part 4 – Packing and tank provisions

PACKING INSTRUCTION (Solid dry, other than powder 1.1D)		
P112(b)		
The following packagings are authorized, provided the general packing provisions of 4.1.1, 4.1.3 and special packing provisions of 4.1.5 are met.		
Inner packagings	Intermediate packagings	Outer packagings
<b>Bags</b> paper, kraft paper, multiwall, water-resistant plastics textile textile, rubberized woven plastics	<b>Bags (for UN 0150 only)</b> plastics textile, plastic coated or lined	<b>Bags</b> woven plastics, sift-proof (5H2) woven plastics, water-resistant (5H3) plastics, film (5H4) textile, sift-proof (5L2) textile, water-resistant (5L3) paper, multiwall, water-resistant (5M2)  <b>Boxes</b> steel (4A) aluminium (4B) other metal (4N) natural wood, ordinary (4C1) natural wood, sift-proof (4C2) plywood (4D) reconstituted wood (4F) fibreboard (4G) plastics, expanded (4H1) plastics, solid (4H2)  <b>Drums</b> steel (1A1, 1A2) aluminium (1B1, 1B2) other metal (1N1, 1N2) plywood (1D) fibre (1G) plastics (1H1, 1H2)
<b>Special packing provisions:</b> PP26 For UN Nos. 0004, 0076, 0078, 0154, 0216, 0219 and 0386, packagings shall be lead-free. PP46 For UN 0209, bags, sift-proof (5H2) are recommended for flake or prilled TNT in the dry state and a maximum net mass of 30 kg. PP47 For UN 0222, inner packagings are not required when the outer packaging is a bag.		

Chapter 4.1 – Use of packagings, including IBCs and large packagings

P112(c) PACKING INSTRUCTION (Solid dry powder 1.1D) P112(c)		
The following packagings are authorized, provided the general packing provisions of 4.1.1, 4.1.3 and special packing provisions of 4.1.5 are met.		
Inner packagings	Intermediate packagings	Outer packagings
<b>Bags</b> paper, multiwall, water-resistant plastics woven plastics  <b>Receptacles</b> fibreboard metal plastics wood	<b>Bags</b> paper, multiwall, water-resistant with inner lining plastics  <b>Receptacles</b> metal plastics wood	<b>Boxes</b> steel (4A) aluminium (4B) other metal (4N) natural wood, ordinary (4C1) natural wood, sift-proof (4C2) plywood (4D) reconstituted wood (4F) fibreboard (4G) plastics, solid (4H2)  <b>Drums</b> steel (1A1, 1A2) aluminium (1B1, 1B2) other metal (1N1, 1N2) plywood (1D) fibre (1G) plastics (1H1, 1H2)
<b>Additional provisions:</b> 1 Inner packagings are not required if drums are used as the outer packaging. 2 The packaging shall be sift-proof.		
<b>Special packing provisions:</b> PP26 For UN Nos. 0004, 0076, 0078, 0154, 0216, 0219 and 0386, packagings shall be lead-free. PP46 For UN 0209, bags, sift-proof (5H2) are recommended for flake or prilled TNT in the dry state and a maximum net mass of 30 kg. PP48 For UN 0504, metal packagings shall not be used.		

P113 PACKING INSTRUCTION P113		
The following packagings are authorized, provided the general packing provisions of 4.1.1, 4.1.3 and special packing provisions of 4.1.5 are met.		
Inner packagings	Intermediate packagings	Outer packagings
<b>Bags</b> paper plastics textile, rubberized  <b>Receptacles</b> fibreboard metal plastics wood	<i>Not necessary</i>	<b>Boxes</b> steel (4A) aluminium (4B) other metal (4N) natural wood, ordinary (4C1) natural wood, sift-proof walls (4C2) plywood (4D) reconstituted wood (4F) fibreboard (4G) plastics, solid (4H2)  <b>Drums</b> steel (1A1, 1A2) aluminium (1B1, 1B2) other metal (1N1, 1N2) plywood (1D) fibre (1G) plastics (1H1, 1H2)
<b>Additional provision:</b> The packaging shall be sift-proof.		
<b>Special packing provisions:</b> PP49 For UN 0094 and UN 0305, no more than 50 g of substance shall be packed in an inner packaging. PP50 For UN 0027, inner packagings are not necessary when drums are used as the outer packaging. PP51 For UN 0028, paper kraft or waxed paper sheets may be used as inner packagings.		

Part 4 – Packing and tank provisions

P114(a) PACKING INSTRUCTION (Solid wetted) P114(a)		
The following packagings are authorized, provided the general packing provisions of 4.1.1, 4.1.3 and special packing provisions of 4.1.5 are met.		
Inner packagings	Intermediate packagings	Outer packagings
<b>Bags</b> plastics textile woven plastics  <b>Receptacles</b> metal plastics wood	<b>Bags</b> plastics textile, plastic coated or lined  <b>Receptacles</b> metal plastics  <b>Dividing partitions</b> wood	<b>Boxes</b> steel (4A) metal, other than steel or aluminium (4N) natural wood, ordinary (4C1) natural wood, sift-proof walls (4C2) plywood (4D) reconstituted wood (4F) fibreboard (4G) plastics, solid (4H2)  <b>Drums</b> steel (1A1, 1A2) aluminium (1B1, 1B2) other metal (1N1, 1N2) fibre (1G) plastics (1H1, 1H2)
<b>Additional provision:</b> Intermediate packagings are not required if leakproof removable head drums are used as the outer packaging.		
<b>Special packing provisions:</b> PP26 For UN Nos. 0077, 0132, 0234, 0235 and 0236, packagings shall be lead-free. PP43 For UN 0342, inner packagings are not required when metal (1A1, 1A2, 1B1, 1B2, 1N1 or 1N2) or plastics (1H1 or 1H2) drums are used as outer packagings.		

P114(b) PACKING INSTRUCTION (Solid dry) P114(b)		
The following packagings are authorized, provided the general packing provisions of 4.1.1, 4.1.3 and special packing provisions of 4.1.5 are met.		
Inner packagings	Intermediate packagings	Outer packagings
<b>Bags</b> paper, kraft plastics textile, sift-proof woven plastics, sift-proof  <b>Receptacles</b> fibreboard metal paper plastics woven plastics, sift-proof wood	<i>Not necessary</i>	<b>Boxes</b> natural wood, ordinary (4C1) natural wood, sift-proof walls (4C2) plywood (4D) reconstituted wood (4F) fibreboard (4G)  <b>Drums</b> steel (1A1, 1A2) aluminium (1B1, 1B2) other metal (1N1, 1N2) plywood (1D) fibre (1G) plastics (1H1, 1H2)
<b>Special packing provisions:</b> PP26 For UN Nos. 0077, 0132, 0234, 0235 and 0236, packagings shall be lead-free. PP48 For UN 0508 and UN 0509, metal packagings shall not be used. PP50 For UN Nos. 0160, 0161 and 0508, inner packagings are not necessary when drums are used as the outer packaging. PP52 For UN 0160 and UN 0161, when metal drums (1A1, 1A2, 1B1, 1B2, 1N1 or 1N2) are used as the outer packaging, metal packagings shall be so constructed that the risk of explosion, by reason of increase in internal pressure from internal or external causes, is prevented.		



Chapter 4.1 – Use of packagings, including IBCs and large packagings

P115	PACKING INSTRUCTION		P115
The following packagings are authorized, provided the general packing provisions of 4.1.1, 4.1.3 and special packing provisions of 4.1.5 are met.			
Inner packagings	Intermediate packagings	Outer packagings	
<b>Receptacles</b> plastics wood	<b>Bags</b> plastics in metal receptacles  <b>Drums</b> metal  <b>Receptacles</b> wood	<b>Boxes</b> natural wood, ordinary (4C1) natural wood, sift-proof walls (4C2) plywood (4D) reconstituted wood (4F)  <b>Drums</b> steel (1A1, 1A2) aluminium (1B1, 1B2) other metal (1N1, 1N2) plywood (1D) fibre (1G) plastics (1H1, 1H2)	
<p><b>Special packing provisions:</b></p> <p><b>PP45</b> For UN 0144, intermediate packagings are not required.</p> <p><b>PP53</b> For UN Nos. 0075, 0143, 0495 and 0497, when boxes are used as the outer packaging, inner packagings shall have taped screw-cap closures and be not more than 5 ℓ capacity each. Inner packagings shall be surrounded with non-combustible absorbent cushioning materials. The amount of absorbent cushioning material shall be sufficient to absorb the liquid contents. Metal receptacles shall be cushioned from each other. Net mass of propellant is limited to 30 kg for each package when outer packagings are boxes.</p> <p><b>PP54</b> For UN Nos. 0075, 0143, 0495 and 0497, when drums are used as the outer packaging and when intermediate packagings are drums, they shall be surrounded with non-combustible cushioning material in a quantity sufficient to absorb the liquid contents. A composite packaging consisting of a plastics receptacle in a metal drum may be used instead of the inner and intermediate packagings. The net volume of propellant in each package shall not exceed 120 ℓ.</p> <p><b>PP55</b> For UN 0144, absorbent cushioning material shall be inserted.</p> <p><b>PP56</b> For UN 0144, metal receptacles may be used as inner packagings.</p> <p><b>PP57</b> For UN Nos. 0075, 0143, 0495 and 0497, bags shall be used as intermediate packagings when boxes are used as outer packagings.</p> <p><b>PP58</b> For UN Nos. 0075, 0143, 0495 and 0497, drums shall be used as intermediate packagings when drums are used as outer packagings.</p> <p><b>PP59</b> For UN 0144, fibreboard boxes (4G) may be used as outer packagings.</p> <p><b>PP60</b> For UN 0144, aluminium drums (1B1 or 1B2) and metal, other than steel or aluminium, drums (1N1 or 1N2) shall not be used.</p>			

Part 4 – Packing and tank provisions

P116	PACKING INSTRUCTION	P116
The following packagings are authorized, provided the general packing provisions of 4.1.1, 4.1.3 and special packing provisions of 4.1.5 are met.		
Inner packagings	Intermediate packagings	Outer packagings
<b>Bags</b> paper, water- and oil-resistant plastics textile, plastic coated or lined woven plastics, sift-proof  <b>Receptacles</b> fibreboard, water-resistant metal plastics wood, sift-proof  <b>Sheets</b> paper, water-resistant paper, waxed plastics	<i>Not necessary</i>	<b>Bags</b> woven plastics (5H1) paper, multiwall, water-resistant (5M2) plastics, film (5H4) textile, sift-proof (5L2) textile, water-resistant (5L3)  <b>Boxes</b> steel (4A) aluminium (4B) other metal (4N) natural wood, ordinary (4C1) natural wood, sift-proof walls (4C2) plywood (4D) reconstituted wood (4F) fibreboard (4G) plastics, solid (4H2)  <b>Drums</b> steel (1A1, 1A2) aluminium (1B1, 1B2) other metal (1N1, 1N2) fibre (1G) plastics (1H1, 1H2) plywood (1D)  <b>Jerricans</b> steel (3A1, 3A2) plastics (3H1, 3H2)
<b>Special packing provisions:</b> PP61 For UN Nos. 0082, 0241, 0331 and 0332, inner packagings are not required if leakproof removable head drums are used as the outer packaging. PP62 For UN Nos. 0082, 0241, 0331 and 0332, inner packagings are not required when the explosive is contained in a material impervious to liquid. PP63 For UN 0081, inner packagings are not required when contained in rigid plastic which is impervious to nitric esters. PP64 For UN 0331, inner packagings are not required when bags (5H2, 5H3 or 5H4) are used as outer packagings. PP65 For UN Nos. 0082, 0241, 0331 and 0332, bags (5H2 or 5H3) may be used as outer packagings. PP66 For UN 0081, bags shall not be used as outer packagings.		

Chapter 4.1 – Use of packagings, including IBCs and large packagings

P130 PACKING INSTRUCTION P130		
The following packagings are authorized, provided the general packing provisions of 4.1.1, 4.1.3 and special packing provisions of 4.1.5 are met.		
Inner packagings	Intermediate packagings	Outer packagings
<i>Not necessary</i>	<i>Not necessary</i>	<b>Boxes</b> steel (4A) aluminium (4B) other metal (4N) natural wood, ordinary (4C1) natural wood, sift-proof walls (4C2) plywood (4D) reconstituted wood (4F) fibreboard (4G) plastics, expanded (4H1) plastics, solid (4H2)  <b>Drums</b> steel (1A1, 1A2) aluminium (1B1, 1B2) other metal (1N1, 1N2) plywood (1D) fibre (1G) plastics (1H1, 1H2)
<b>Special packing provision:</b> <b>PP67</b> The following applies to UN Nos. 0006, 0009, 0010, 0015, 0016, 0018, 0019, 0034, 0035, 0038, 0039, 0048, 0056, 0137, 0138, 0168, 0169, 0171, 0181, 0182, 0183, 0186, 0221, 0243, 0244, 0245, 0246, 0254, 0280, 0281, 0286, 0287, 0297, 0299, 0300, 0301, 0303, 0321, 0328, 0329, 0344, 0345, 0346, 0347, 0362, 0363, 0370, 0412, 0424, 0425, 0434, 0435, 0436, 0437, 0438, 0451, 0488, and 0502: large and robust explosives articles, normally intended for military use, without their means of initiation or with their means of initiation containing at least two effective protective features, may be transported unpackaged. When such articles have propelling charges or are self-propelled, their ignition systems shall be protected against stimuli encountered during normal conditions of transport. A negative result in Test Series 4 on an unpackaged article indicates that the article can be considered for transport unpackaged. Such unpackaged articles may be fixed to cradles or contained in crates or other suitable handling devices.		

P131 PACKING INSTRUCTION P131		
The following packagings are authorized, provided the general packing provisions of 4.1.1, 4.1.3 and special packing provisions of 4.1.5 are met.		
Inner packagings	Intermediate packagings	Outer packagings
<b>Bags</b> paper plastics  <b>Receptacles</b> fibreboard metal plastics wood  <b>Reels</b>	<i>Not necessary</i>	<b>Boxes</b> steel (4A) aluminium (4B) other metal (4N) natural wood, ordinary (4C1) natural wood, sift-proof walls (4C2) plywood (4D) reconstituted wood (4F) fibreboard (4G)  <b>Drums</b> steel (1A1, 1A2) aluminium (1B1, 1B2) other metal (1N1, 1N2) plywood (1D) fibre (1G) plastics (1H1, 1H2)
<b>Special packing provision:</b> <b>PP68</b> For UN Nos. 0029, 0267 and 0455, bags and reels shall not be used as inner packagings.		

Part 4 – Packing and tank provisions

P132(a) PACKING INSTRUCTION P132(a) (Articles consisting of closed metal, plastics or fibreboard casings that contain a detonating explosive, or consisting of plastics-bonded detonating explosives)		
The following packagings are authorized, provided the general packing provisions of 4.1.1, 4.1.3 and special packing provisions of 4.1.5 are met.		
Inner packagings	Intermediate packagings	Outer packagings
<i>Not necessary</i>	<i>Not necessary</i>	<b>Boxes</b> steel (4A) aluminium (4B) other metal (4N) natural wood, ordinary (4C1) natural wood, sift-proof walls (4C2) plywood (4D) reconstituted wood (4F) fibreboard (4G) plastics, solid (4H2)
P132(b) PACKING INSTRUCTION P132(b) (Articles without closed casings)		
The following packagings are authorized, provided the general packing provisions of 4.1.1, 4.1.3 and special packing provisions of 4.1.5 are met.		
Inner packagings	Intermediate packagings	Outer packagings
<b>Receptacles</b> fibreboard metal plastics wood  <b>Sheets</b> paper plastics	<i>Not necessary</i>	<b>Boxes</b> steel (4A) aluminium (4B) other metal (4N) natural wood, ordinary (4C1) natural wood, sift-proof walls (4C2) plywood (4D) reconstituted wood (4F) fibreboard (4G) plastics, solid (4H2)
P133 PACKING INSTRUCTION P133		
The following packagings are authorized, provided the general packing provisions of 4.1.1, 4.1.3 and special packing provisions of 4.1.5 are met.		
Inner packagings	Intermediate packagings	Outer packagings
<b>Receptacles</b> fibreboard metal plastics wood  <b>Trays, fitted with dividing partitions</b> fibreboard plastics wood	<b>Receptacles</b> fibreboard metal plastics wood	<b>Boxes</b> steel (4A) aluminium (4B) other metal (4N) natural wood, ordinary (4C1) natural wood, sift-proof walls (4C2) plywood (4D) reconstituted wood (4F) fibreboard (4G) plastics, solid (4H2)
<b>Additional provision:</b> Receptacles are only required as intermediate packagings when the inner packagings are trays.		
<b>Special packing provision:</b> PP69 For UN Nos. 0043, 0212, 0225, 0268 and 0306, trays shall not be used as inner packagings.		

Chapter 4.1 – Use of packagings, including IBCs and large packagings

P134 PACKING INSTRUCTION P134		
The following packagings are authorized, provided the general packing provisions of 4.1.1, 4.1.3 and special packing provisions of 4.1.5 are met.		
Inner packagings	Intermediate packagings	Outer packagings
<b>Bags</b> water-resistant  <b>Receptacles</b> fibreboard metal plastics wood  <b>Sheets</b> fibreboard, corrugated  <b>Tubes</b> fibreboard	<i>Not necessary</i>	<b>Boxes</b> steel (4A) aluminium (4B) other metal (4N) natural wood, ordinary (4C1) natural wood, sift-proof walls (4C2) plywood (4D) reconstituted wood (4F) fibreboard (4G) plastics, expanded (4H1) plastics, solid (4H2)  <b>Drums</b> steel (1A1, 1A2) aluminium (1B1, 1B2) other metal (1N1, 1N2) plywood (1D) fibre (1G) plastics (1H1, 1H2)

P135 PACKING INSTRUCTION P135		
The following packagings are authorized, provided the general packing provisions of 4.1.1, 4.1.3 and special packing provisions of 4.1.5 are met.		
Inner packagings	Intermediate packagings	Outer packagings
<b>Bags</b> paper plastics  <b>Receptacles</b> fibreboard metal plastics wood  <b>Sheets</b> paper plastics	<i>Not necessary</i>	<b>Boxes</b> steel (4A) aluminium (4B) other metal (4N) natural wood, ordinary (4C1) natural wood, sift-proof walls (4C2) plywood (4D) reconstituted wood (4F) fibreboard (4G) plastics, expanded (4H1) plastics, solid (4H2)  <b>Drums</b> steel (1A1, 1A2) aluminium (1B1, 1B2) other metal (1N1, 1N2) plywood (1D) fibre (1G) plastics (1H1, 1H2)

P136 PACKING INSTRUCTION P136		
The following packagings are authorized, provided the general packing provisions of 4.1.1, 4.1.3 and special packing provisions of 4.1.5 are met.		
Inner packagings	Intermediate packagings	Outer packagings
<b>Bags</b> plastics textile  <b>Boxes</b> fibreboard plastics wood  <b>Dividing partitions in the outer packagings</b>	<i>Not necessary</i>	<b>Boxes</b> steel (4A) aluminium (4B) other metal (4N) natural wood, ordinary (4C1) natural wood, sift-proof walls (4C2) plywood (4D) reconstituted wood (4F) fibreboard (4G) plastics, solid (4H2)  <b>Drums</b> steel (1A1, 1A2) aluminium (1B1, 1B2) other metal (1N1, 1N2) plywood (1D) fibre (1G) plastics (1H1, 1H2)

Part 4 – Packing and tank provisions

P137 PACKING INSTRUCTION P137		
The following packagings are authorized, provided the general packing provisions of 4.1.1, 4.1.3 and special packing provisions of 4.1.5 are met.		
Inner packagings	Intermediate packagings	Outer packagings
<b>Bags</b> plastics  <b>Boxes</b> fibreboard wood  <b>Tubes</b> fibreboard metal plastics  Dividing partitions in the outer packagings	<i>Not necessary</i>	<b>Boxes</b> steel (4A) aluminium (4B) other metal (4N) natural wood, ordinary (4C1) natural wood, sift-proof walls (4C2) plywood (4D) reconstituted wood (4F) fibreboard (4G)  <b>Drums</b> steel (1A1, 1A2) aluminium (1B1, 1B2) other metal (1N1, 1N2) plywood (1D) fibre (1G) plastics (1H1, 1H2)
<b>Special packing provision:</b> PP70 For UN Nos. 0059, 0439, 0440 and 0441, when the shaped charges are packed singly, the conical cavity shall face downwards and the package shall be marked "THIS SIDE UP". When the shaped charges are packed in pairs, the conical cavities shall face inwards to minimize the jetting effect in the event of accidental initiation.		

P138 PACKING INSTRUCTION P138		
The following packagings are authorized, provided the general packing provisions of 4.1.1, 4.1.3 and special packing provisions of 4.1.5 are met.		
Inner packagings	Intermediate packagings	Outer packagings
<b>Bags</b> plastics	<i>Not necessary</i>	<b>Boxes</b> steel (4A) aluminium (4B) other metal (4N) natural wood, ordinary (4C1) natural wood, sift-proof walls (4C2) plywood (4D) reconstituted wood (4F) fibreboard (4G) plastics, solid (4H2)  <b>Drums</b> steel (1A1, 1A2) aluminium (1B1, 1B2) other metal (1N1, 1N2) plywood (1D) fibre (1G) plastics (1H1, 1H2)
<b>Additional provision:</b> If the ends of the articles are sealed, inner packagings are not necessary.		

Chapter 4.1 – Use of packagings, including IBCs and large packagings

P139 PACKING INSTRUCTION P139		
The following packagings are authorized, provided the general packing provisions of 4.1.1, 4.1.3 and special packing provisions of 4.1.5 are met.		
Inner packagings	Intermediate packagings	Outer packagings
<b>Bags</b> plastics  <b>Receptacles</b> fibreboard metal plastics wood  <b>Reels</b>  <b>Sheets</b> paper plastics	<i>Not necessary</i>	<b>Boxes</b> steel (4A) aluminium (4B) other metal (4N) natural wood, ordinary (4C1) natural wood, sift-proof walls (4C2) plywood (4D) reconstituted wood (4F) fibreboard (4G) plastics, solid (4H2)  <b>Drums</b> steel (1A1, 1A2) aluminium (1B1, 1B2) other metal (1N1, 1N2) plywood (1D) fibre (1G) plastics (1H1, 1H2)
<b>Special packing provisions:</b> <b>PP71</b> For UN Nos. 0065, 0102, 0104, 0289 and 0290, the ends of the detonating cord shall be sealed; for example, by a plug firmly fixed so that the explosive cannot escape. The ends of flexible detonating cord shall be fastened securely. <b>PP72</b> For UN 0065 and UN 0289, inner packagings are not required when they are in coils.		

P140 PACKING INSTRUCTION P140		
The following packagings are authorized, provided the general packing provisions of 4.1.1, 4.1.3 and special packing provisions of 4.1.5 are met.		
Inner packagings	Intermediate packagings	Outer packagings
<b>Bags</b> plastics  <b>Reels</b>  <b>Sheets</b> paper, kraft plastics  <b>Receptacles</b> wood	<i>Not necessary</i>	<b>Boxes</b> steel (4A) aluminium (4B) other metal (4N) natural wood, ordinary (4C1) natural wood, sift-proof walls (4C2) plywood (4D) reconstituted wood (4F) fibreboard (4G) plastics, solid (4H2)  <b>Drums</b> steel (1A1, 1A2) aluminium (1B1, 1B2) other metal (1N1, 1N2) plywood (1D) fibre (1G) plastics (1H1, 1H2)
<b>Special packing provisions:</b> <b>PP73</b> For UN 0105, no inner packagings are required if the ends are sealed. <b>PP74</b> For UN 0101, the packaging shall be sift-proof except when the fuse is covered by a paper tube and both ends of the tube are covered with removable caps. <b>PP75</b> For UN 0101, steel, aluminium or other metal boxes or drums shall not be used.		

Part 4 – Packing and tank provisions

P141 PACKING INSTRUCTION P141		
The following packagings are authorized, provided the general packing provisions of 4.1.1, 4.1.3 and special packing provisions of 4.1.5 are met.		
Inner packagings	Intermediate packagings	Outer packagings
<b>Receptacles</b> fibreboard metal plastics wood  <b>Trays, fitted with dividing partitions</b> plastics wood  <b>Dividing partitions in the outer packagings</b>	<i>Not necessary</i>	<b>Boxes</b> steel (4A) aluminium (4B) other metal (4N) natural wood, ordinary (4C1) natural wood, sift-proof walls (4C2) plywood (4D) reconstituted wood (4F) fibreboard (4G) plastics, solid (4H2)  <b>Drums</b> steel (1A1, 1A2) aluminium (1B1, 1B2) other metal (1N1, 1N2) plywood (1D) fibre (1G) plastics (1H1, 1H2)

P142 PACKING INSTRUCTION P142		
The following packagings are authorized, provided the general packing provisions of 4.1.1, 4.1.3 and special packing provisions of 4.1.5 are met.		
Inner packagings	Intermediate packagings	Outer packagings
<b>Bags</b> paper plastics  <b>Receptacles</b> fibreboard metal plastics wood  <b>Sheets</b> paper  <b>Trays, fitted with dividing partitions</b> plastics	<i>Not necessary</i>	<b>Boxes</b> steel (4A) aluminium (4B) other metal (4N) natural wood, ordinary (4C1) natural wood, sift-proof walls (4C2) plywood (4D) reconstituted wood (4F) fibreboard (4G) plastics, solid (4H2)  <b>Drums</b> steel (1A1, 1A2) aluminium (1B1, 1B2) other metal (1N1, 1N2) plywood (1D) fibre (1G) plastics (1H1, 1H2)



Chapter 4.1 – Use of packagings, including IBCs and large packagings

P143 PACKING INSTRUCTION P143		
The following packagings are authorized, provided the general packing provisions of 4.1.1, 4.1.3 and special packing provisions of 4.1.5 are met.		
Inner packagings	Intermediate packagings	Outer packagings
<b>Bags</b> paper, kraft plastics textile textile, rubberized  <b>Receptacles</b> fibreboard metal plastics wood  <b>Trays, fitted with dividing partitions</b> plastics wood	<i>Not necessary</i>	<b>Boxes</b> steel (4A) aluminium (4B) other metal (4N) natural wood, ordinary (4C1) natural wood, sift-proof walls (4C2) plywood (4D) reconstituted wood (4F) fibreboard (4G) plastics, solid (4H2)  <b>Drums</b> steel (1A1, 1A2) aluminium (1B1, 1B2) other metal (1N1, 1N2) plywood (1D) fibre (1G) plastics (1H1, 1H2)
<b>Additional provision:</b> Instead of the above inner and outer packagings, composite packagings (6HH2) (plastics receptacle with outer solid box) may be used.		
<b>Special packing provision:</b> PP76 For UN Nos. 0271, 0272, 0415 and 0491, when metal packagings are used, metal packagings shall be so constructed that the risk of explosion, by reason of increase in internal pressure from internal or external causes, is prevented.		

P144 PACKING INSTRUCTION P144		
The following packagings are authorized, provided the general packing provisions of 4.1.1, 4.1.3 and special packing provisions of 4.1.5 are met.		
Inner packagings	Intermediate packagings	Outer packagings
<b>Receptacles</b> fibreboard metal plastics wood  <b>Dividing partitions in the outer packagings</b>	<i>Not necessary</i>	<b>Boxes</b> steel (4A) aluminium (4B) other metal (4N) natural wood, ordinary with metal liner (4C1) plywood (4D) with metal liner reconstituted wood with metal liner (4F) plastics, expanded (4H1) plastics, solid (4H2)  <b>Drums</b> steel (1A1, 1A2) aluminium (1B1, 1B2) other metal (1N1, 1N2) plastics (1H1, 1H2)
<b>Special packing provision:</b> PP 77 For UN 0248 and UN 0249, packagings shall be protected against the ingress of water. When water-activated contrivances are transported unpackaged, they shall be provided with at least two independent protective features which prevent the ingress of water.		

Part 4 – Packing and tank provisions

P200	PACKING INSTRUCTION	P200
<p>For pressure receptacles, the general packing provisions of 4.1.6.1 shall be met. In addition, for MEGCs, the general requirements of 4.2.4 shall be met.</p> <p>Cylinders, tubes, pressure drums, bundles of cylinders constructed as specified in 6.2 and MEGCs constructed as specified in 6.7.5 are authorized for the transport of a specific substance when specified in the following tables. For some substances, the special packing provisions may prohibit a particular type of cylinder, tube, pressure drum or bundle of cylinders.</p>		
<p>(1) Pressure receptacles containing toxic substances with an <math>LC_{50}</math> less than or equal to <math>200 \text{ mL/m}^3</math> (ppm) as specified in the table shall not be equipped with any pressure relief device. Pressure relief devices shall be fitted on pressure receptacles used for the transport of UN 1013 carbon dioxide and UN 1070 nitrous oxide. Other pressure receptacles shall be fitted with a pressure relief device if specified by the competent authority of the country of use. The type of pressure relief device, the set-to-discharge pressure and relief capacity of pressure relief devices, if required, shall be specified by the competent authority of the country of use.</p>		
<p>(2) The following three tables cover compressed gases (table 1), liquefied and dissolved gases (table 2) and substances not in class 2 (table 3). They provide:</p> <p>(a) the UN Number, Proper Shipping Name and description, and classification of the substance;</p> <p>(b) the <math>LC_{50}</math> for toxic substances;</p> <p>(c) the types of pressure receptacles authorized for the substance, shown by the letter "X";</p> <p>(d) the maximum test period for periodic inspection of the pressure receptacles;</p> <p><b>Note:</b> For pressure receptacles which make use of composite materials, the periodic inspection frequencies shall be as determined by the competent authority which approved the receptacles.</p> <p>(e) the minimum test pressure of the pressure receptacles;</p> <p>(f) the maximum working pressure of the pressure receptacles for compressed gases (where no value is given, the working pressure shall not exceed two thirds of the test pressure) or the maximum filling ratio(s) dependent on the test pressure(s) for liquefied and dissolved gases;</p> <p>(g) special packing provisions that are specific to a substance.</p>		
<p>(3) In no case shall pressure receptacles be filled in excess of the limit permitted in the following requirements.</p> <p>(a) For compressed gases, the working pressure shall be not more than two thirds of the test pressure of the pressure receptacles. Restrictions to this upper limit on working pressure are imposed by special packing provision "o" in (4) below. In no case shall the internal pressure at <math>65^\circ\text{C}</math> exceed the test pressure.</p> <p>(b) For high pressure liquefied gases, the filling ratio shall be such that the settled pressure at <math>65^\circ\text{C}</math> does not exceed the test pressure of the pressure receptacles.</p> <p>The use of test pressures and filling ratios other than those in the table is permitted, except where (4), special packing provision "o" applies, provided that:</p> <p>(i) the criterion of (4), special packing provision "r" is met when applicable; or</p> <p>(ii) the above criterion is met in all other cases.</p> <p>For high pressure liquefied gases and gas mixtures for which relevant data are not available, the maximum filling ratio (<i>FR</i>) shall be determined as follows:</p> $FR = 8.5 \times 10^{-4} \times d_g \times P_h$ <p>where <math>FR</math> = maximum filling ratio  <math>d_g</math> = gas density (at <math>15^\circ\text{C}</math>, 1 bar) (in <math>\text{g/l}</math>)  <math>P_h</math> = minimum test pressure (in bar)</p> <p>If the density of the gas is unknown, the maximum filling ratio shall be determined as follows:</p> $FR = \frac{P_h \times MM \times 10^{-3}}{R \times 338}$ <p>where <math>FR</math> = maximum filling ratio  <math>P_h</math> = minimum test pressure (in bar)  <math>MM</math> = molecular mass (in <math>\text{g/mol}</math>)  <math>R</math> = <math>8.31451 \times 10^{-2} \text{ bar}\cdot\text{l/mol}\cdot\text{K}</math> (gas constant)</p> <p>For gas mixtures, the average molecular mass is to be taken, taking into account the volumetric concentrations of the various components.</p>		
<p>(c) For low pressure liquefied gases, the maximum mass of contents per litre of water capacity (filling factor) shall equal 0.95 times the density of the liquid phase at <math>50^\circ\text{C}</math>; in addition, the liquid phase shall not fill the pressure receptacle at any temperature up to <math>60^\circ\text{C}</math>. The test pressure of the pressure receptacle shall be at least equal to the vapour pressure (absolute) of the liquid at <math>65^\circ\text{C}</math>, minus 100 kPa (1 bar).</p> <p>For low pressure liquefied gases and gas mixtures for which relevant data are not available, the maximum filling ratio shall be determined as follows:</p> $FR = (0.0032 \times BP - 0.24) \times d_l$ <p>where <math>FR</math> = maximum filling ratio  <math>BP</math> = boiling point (in kelvin)  <math>d_l</math> = density of the liquid at boiling point (in <math>\text{kg/l}</math>)</p>		
<p>(d) For UN 1001, acetylene, dissolved, and UN 3374 acetylene, solvent free, see (4), special packing provision "p".</p>		

P200	PACKING INSTRUCTION (continued)	P200
(4)	<p>Special packing provisions:</p> <p><i>Material compatibility</i></p> <p>a: Aluminium alloy pressure receptacles shall not be used.</p> <p>b: Copper valves shall not be used.</p> <p>c: Metal parts in contact with the contents shall not contain more than 65% copper.</p> <p>d: When steel pressure receptacles are used, only those bearing the "H" mark in accordance with 6.2.2.7.4 (p) are permitted.</p> <p><i>Requirements for toxic substances with an LC<sub>50</sub> less than or equal to 200 ml/m<sup>3</sup> (ppm)</i></p> <p>k: Valve outlets shall be fitted with pressure-retaining gas-tight plugs or caps having threads that match those of the valve outlets.</p> <p>Each cylinder within a bundle shall be fitted with an individual valve that shall be closed during transport. After filling, the manifold shall be evacuated, purged and plugged.</p> <p>Bundles containing UN 1045 fluorine, compressed, may be constructed with isolation valves on groups of cylinders not exceeding 150 litres total water capacity instead of isolation valves on every cylinder.</p> <p>Cylinders and individual cylinders in a bundle shall have a test pressure greater than or equal to 200 bar and a minimum wall thickness of 3.5 mm for aluminium alloy or 2 mm for steel. Individual cylinders not complying with this requirement shall be transported in a rigid outer packaging that will adequately protect the cylinder and its fittings and meeting the packing group I performance level. Pressure drums shall have a minimum wall thickness as specified by the competent authority.</p> <p>Pressure receptacles shall not be fitted with a pressure relief device.</p> <p>Cylinders and individual cylinders in a bundle shall be limited to a maximum water capacity of 85 ℓ.</p> <p>Each valve shall be capable of withstanding the test pressure of the pressure receptacle and be connected directly to the pressure receptacle by either a taper thread or other means which meets the requirements of ISO 10692-2:2001.</p> <p>Each valve shall either be of the packless type with non-perforated diaphragm, or be of a type which prevents leakage through or past the packing.</p> <p>Each pressure receptacle shall be tested for leakage after filling.</p> <p><i>Gas specific provisions</i></p> <p>l: UN 1040 ethylene oxide may also be packed in hermetically sealed glass or metal inner packagings suitably cushioned in fibreboard, wooden or metal boxes meeting the packing group I performance level. The maximum quantity permitted in any glass inner packaging is 30 g, and the maximum quantity permitted in any metal inner packaging is 200 g. After filling, each inner packaging shall be determined to be leaktight by placing the inner packaging in a hot water bath at a temperature, and for a period of time, sufficient to ensure that an internal pressure equal to the vapour pressure of ethylene oxide at 55°C is achieved. The maximum net mass in any outer packaging shall not exceed 2.5 kg.</p> <p>m: Pressure receptacles shall be filled to a working pressure not exceeding 5 bar.</p> <p>n: Cylinders and individual cylinders in a bundle shall contain not more than 5 kg of the gas. When bundles containing UN 1045 fluorine, compressed are divided into groups of cylinders in accordance with special packing provision "k" each group shall contain not more than 5 kg of the gas.</p> <p>o: In no case shall the working pressure or filling ratio shown in the table be exceeded.</p> <p>p: For UN 1001 acetylene, dissolved and UN 3374 acetylene, solvent free: cylinders shall be filled with a homogeneous monolithic porous material; the working pressure and the quantity of acetylene shall not exceed the values prescribed in the approval or in ISO 3807-1:2000 or ISO 3807-2:2000, as applicable. For UN 1001 acetylene, dissolved: cylinders shall contain a quantity of acetone or suitable solvent as specified in the approval (see ISO 3807-1:2000 or ISO 3807-2:2000, as applicable); cylinders fitted with pressure relief devices or manifolded together shall be transported vertically. The test pressure of 52 bar applies only to cylinders conforming to ISO 3807-2:2000.</p> <p>q: Valve outlets of pressure receptacles for pyrophoric gases or flammable mixtures of gases containing more than 1% of pyrophoric compounds shall be fitted with gas-tight plugs or caps. When these pressure receptacles are manifolded in a bundle, each of the pressure receptacles shall be fitted with an individual valve that shall be closed during transport, and the outlet of the manifold valve shall be fitted with a pressure-retaining gas-tight plug or cap. Gas-tight plugs or caps shall have threads that match those of the valve outlets.</p> <p>r: The filling ratio of this gas shall be limited such that, if complete decomposition occurs, the pressure does not exceed two thirds of the test pressure of the pressure receptacle.</p> <p>ra: This gas may also be packed in capsules under the following conditions:</p> <p>(i) The mass of gas shall not exceed 150 g per capsule;</p> <p>(ii) The capsules shall be free from faults liable to impair the strength;</p> <p>(iii) The leakproofness of the closure shall be ensured by an additional device (cap, crown, seal, binding, etc.) capable of preventing any leakage of the closure during transport;</p> <p>(iv) The capsules shall be placed in an outer packaging of sufficient strength. A package shall not weigh more than 75 kg.</p>	

P200	PACKING INSTRUCTION (continued)	P200
	<p>s: Aluminium alloy pressure receptacles shall be:</p> <ul style="list-style-type: none"> <li>– equipped only with brass or stainless steel valves; and</li> <li>– cleaned in accordance with ISO 11621:1997 and not contaminated with oil.</li> </ul> <p>t: (i) The wall thickness of pressure receptacles shall be not less than 3 mm. (ii) Prior to transport, it shall be ensured that the pressure has not risen due to potential hydrogen generation.</p> <p><i>Periodic inspection</i></p> <p>u: The interval between periodic tests may be extended to 10 years for aluminium alloy pressure receptacles when the alloy of the pressure receptacle has been subjected to stress corrosion testing as specified in ISO 7866:1999.</p> <p>v: The interval between periodic inspections for steel cylinders may be extended to 15 years if approved by the competent authority of the country of use.</p> <p><i>Requirements for N.O.S. descriptions and for mixtures</i></p> <p>z: The construction materials of the pressure receptacles and their accessories shall be compatible with the contents and shall not react to form harmful or dangerous compounds therewith. The test pressure and filling ratio shall be calculated in accordance with the relevant requirements of (3). Toxic substances with an LC<sub>50</sub> less than or equal to 200 ml/m<sup>3</sup> shall not be transported in tubes, pressure drums or MEGCs and shall meet the requirements of special packing provision "k". However, UN 1975 nitric oxide and dinitrogen tetroxide mixtures may be transported in pressure drums. For pressure receptacles containing pyrophoric gases or flammable mixtures of gases containing more than 1% pyrophoric compounds, the requirements of special packing provision "q" shall be met. The necessary steps shall be taken to prevent dangerous reactions (i.e. polymerization or decomposition) during transport. If necessary, stabilization or addition of an inhibitor shall be required. Mixtures containing UN 1911 diborane shall be filled to a pressure such that, if complete decomposition of the diborane occurs, two thirds of the test pressure of the pressure receptacle shall not be exceeded. Mixtures containing UN 2192 germane, other than mixtures of up to 35% germane in hydrogen or nitrogen or up to 28% germane in helium or argon, shall be filled to a pressure such that, if complete decomposition of the germane occurs, two thirds of the test pressure of the pressure receptacle shall not be exceeded.</p>	

Chapter 4.1 – Use of packagings, including IBCs and large packagings

P200 PACKING INSTRUCTION (continued) P200													
Table 1: COMPRESSED GASES													
UN No.	Proper Shipping Name	Class	Subsidiary risk	LC <sub>50</sub> , ml/m <sup>3</sup>	Cylinders	Tubes	Pressure drums	Bundles of cylinders	MEGCs	Test period, years	Test pressure, bar <sup>a</sup>	Maximum working pressure, bar <sup>a</sup>	Special packing provisions
1002	AIR, COMPRESSED	2.2			X	X	X	X	X	10			
1006	ARGON, COMPRESSED	2.2			X	X	X	X	X	10			
1016	CARBON MONOXIDE, COMPRESSED	2.3	2.1	3760	X	X	X	X	X	5			u
1023	COAL GAS, COMPRESSED	2.3	2.1		X	X	X	X	X	5			
1045	FLUORINE, COMPRESSED	2.3	5.1, 8	185	X			X		5	200	30	a, k, n, o
1046	HELIUM, COMPRESSED	2.2			X	X	X	X	X	10			
1049	HYDROGEN, COMPRESSED	2.1			X	X	X	X	X	10			d
1056	KRYPTON, COMPRESSED	2.2			X	X	X	X	X	10			
1065	NEON, COMPRESSED	2.2			X	X	X	X	X	10			
1066	NITROGEN, COMPRESSED	2.2			X	X	X	X	X	10			
1071	OIL GAS, COMPRESSED	2.3	2.1		X	X	X	X	X	5			
1072	OXYGEN, COMPRESSED	2.2	5.1		X	X	X	X		10			s
1612	HEXAETHYL TETRAPHOSPHATE AND COMPRESSED GAS MIXTURE	2.3			X	X	X	X		5			z
1660	NITRIC OXIDE, COMPRESSED	2.3	5.1, 8	115	X			X		5	225	33	k, o
1953	COMPRESSED GAS, TOXIC, FLAMMABLE, N.O.S.	2.3	2.1	≤ 5000	X	X	X	X	X	5			z
1954	COMPRESSED GAS, FLAMMABLE, N.O.S	2.1			X	X	X	X	X	10			z
1955	COMPRESSED GAS, TOXIC, N.O.S.	2.3		≤ 5000	X	X	X	X	X	5			z
1956	COMPRESSED GAS, N.O.S.	2.2			X	X	X	X	X	10			z
1957	DEUTERIUM, COMPRESSED	2.1			X	X	X	X	X	10			d
1964	HYDROCARBON GAS MIXTURE, COMPRESSED, N.O.S.	2.1			X	X	X	X	X	10			z
1971	METHANE, COMPRESSED or NATURAL GAS, COMPRESSED with high methane content	2.1			X	X	X	X	X	10			
2034	HYDROGEN AND METHANE MIXTURE, COMPRESSED	2.1			X	X	X	X	X	10			d
2190	OXYGEN DIFLUORIDE, COMPRESSED	2.3	5.1, 8	2.6	X			X		5	200	30	a, k, n, o
3156	COMPRESSED GAS, OXIDIZING, N.O.S.	2.2	5.1		X	X	X	X	X	10			z
3303	COMPRESSED GAS, TOXIC, OXIDIZING, N.O.S.	2.3	5.1	≤ 5000	X	X	X	X	X	5			z
3304	COMPRESSED GAS, TOXIC, CORROSIVE, N.O.S.	2.3	8	≤ 5000	X	X	X	X	X	5			z
3305	COMPRESSED GAS, TOXIC, FLAMMABLE, CORROSIVE, N.O.S.	2.3	2.1, 8	≤ 5000	X	X	X	X	X	5			z
3306	COMPRESSED GAS, TOXIC, OXIDIZING, CORROSIVE, N.O.S.	2.3	5.1, 8	≤ 5000	X	X	X	X	X	5			z

<sup>a</sup> Where the entries are blank, the maximum working pressure shall not exceed two thirds of the test pressure.

Part 4 – Packing and tank provisions

P200	PACKING INSTRUCTION (continued)											P200	
Table 2: LIQUEFIED GASES AND DISSOLVED GASES													
UN No.	Proper Shipping Name	Class	Subsidiary risk	LC <sub>50</sub> , ml/m <sup>3</sup>	Cylinders	Tubes	Pressure drums	Bundles of cylinders	MEGCs	Test period, years	Test pressure, bar*	Filling ratio	Special packing provisions
1001	ACETYLENE, DISSOLVED	2.1			X			X		10	60 52		c, p
1005	AMMONIA, ANHYDROUS	2.3	8	4000	X	X	X	X	X	5	29	0.54	b
1008	BORON TRIFLUORIDE	2.3	8	387	X	X	X	X	X	5	225 300	0.715 0.86	a
1009	BROMOTRIFLUOROMETHANE (REFRIGERANT GAS R 13B1)	2.2			X	X	X	X	X	10	42 120 250	1.13 1.44 1.60	
1010	BUTADIENES, STABILIZED (1,2-butadiene), or	2.1			X	X	X	X	X	10	10	0.59	
1010	BUTADIENES, STABILIZED (1,3-butadiene), or	2.1			X	X	X	X	X	10	10	0.55	
1010	BUTADIENES AND HYDROCARBON MIXTURE, STABILIZED with more than 40% butadienes	2.1			X	X	X	X	X	10			v, z
1011	BUTANE	2.1			X	X	X	X	X	10	10	0.52	v
1012	BUTYLENE (butylenes mixture) or	2.1			X	X	X	X	X	10	10	0.50	z
1012	BUTYLENE (1-butylene) or	2.1			X	X	X	X	X	10	10	0.53	
1012	BUTYLENE (cis-2-butylene) or	2.1			X	X	X	X	X	10	10	0.55	
1012	BUTYLENE (trans-2-butylene)	2.1			X	X	X	X	X	10	10	0.54	
1013	CARBON DIOXIDE	2.2			X	X	X	X	X	10	190 250	0.68 0.76	
1017	CHLORINE	2.3	5.1, 8	293	X	X	X	X	X	5	22	1.25	a
1018	CHLORODIFLUOROMETHANE (REFRIGERANT GAS R 22)	2.2			X	X	X	X	X	10	27	1.03	
1020	CHLOROPENTAFLUOROETHANE (REFRIGERANT GAS R 115)	2.2			X	X	X	X	X	10	25	1.05	
1021	1-CHLORO-1,2,2,2-TETRAFLUOROETHANE (REFRIGERANT GAS R 124)	2.2			X	X	X	X	X	10	11	1.20	
1022	CHLOROTRIFLUOROMETHANE (REFRIGERANT GAS R 13)	2.2			X	X	X	X	X	10	100 120 190 250	0.83 0.90 1.04 1.11	
1026	CYANOGEN	2.3	2.1	350	X	X	X	X	X	5	100	0.70	u
1027	CYCLOPROPANE	2.1			X	X	X	X	X	10	18	0.55	
1028	DICHLORODIFLUOROMETHANE (REFRIGERANT GAS R 12)	2.2			X	X	X	X	X	10	16	1.15	
1029	DICHLOROFLUOROMETHANE (REFRIGERANT GAS R 21)	2.2			X	X	X	X	X	10	10	1.23	
1030	1,1-DIFLUOROETHANE (REFRIGERANT GAS R 152a)	2.1			X	X	X	X	X	10	16	0.79	
1032	DIMETHYLAMINE, ANHYDROUS	2.1			X	X	X	X	X	10	10	0.59	b
1033	DIMETHYL ETHER	2.1			X	X	X	X	X	10	18	0.58	
1035	ETHANE	2.1			X	X	X	X	X	10	95 120 300	0.25 0.30 0.40	
1036	ETHYLAMINE	2.1			X	X	X	X	X	10	10	0.61	b
1037	ETHYL CHLORIDE	2.1			X	X	X	X	X	10	10	0.80	a, ra
1039	ETHYL METHYL ETHER	2.1			X	X	X	X	X	10	10	0.64	
1040	ETHYLENE OXIDE or ETHYLENE OXIDE WITH NITROGEN up to a total pressure of 1 MPa (10 bar) at 50°C	2.3	2.1	2900	X	X	X	X	X	5	15	0.78	l

\* Where the entries are blank, the maximum working pressure shall not exceed two thirds of the test pressure.

Chapter 4.1 – Use of packagings, including IBCs and large packagings

P200		PACKING INSTRUCTION (continued)										P200	
Table 2: LIQUEFIED GASES AND DISSOLVED GASES (continued)													
UN No.	Proper Shipping Name	Class	Subsidiary risk	LC <sub>50</sub> , ml/m <sup>3</sup>	Cylinders	Tubes	Pressure drums	Bundles of cylinders	MEGCs	Test period, years	Test pressure, bar <sup>a</sup>	Filling ratio	Special packing provisions
1041	ETHYLENE OXIDE AND CARBON DIOXIDE MIXTURE with more than 9% ethylene oxide but not more than 87%	2.1			X	X	X	X	X	10	190 250	0.66 0.75	
1043	FERTILIZER AMMONIATING SOLUTION with free ammonia	2.2			X		X	X		5			b, z
1048	HYDROGEN BROMIDE, ANHYDROUS	2.3	8	2860	X	X	X	X	X	5	60	1.51	a, d
1050	HYDROGEN CHLORIDE, ANHYDROUS	2.3	8	2810	X	X	X	X	X	5	100 120 150 200	0.30 0.56 0.67 0.74	a, d a, d a, d
1053	HYDROGEN SULPHIDE	2.3	2.1	712	X	X	X	X	X	5	48	0.67	d, u
1055	ISOBUTYLENE	2.1			X	X	X	X	X	10	10	0.52	
1058	LIQUEFIED GASES, non-flammable, charged with nitrogen, carbon dioxide or air	2.2			X	X	X	X	X	10	Test pressure = 1.5 × working pressure		
1060	METHYLACETYLENE AND PROPADIENE MIXTURE, STABILIZED or	2.1			X	X	X	X	X	10			c, z
1060	METHYLACETYLENE AND PROPADIENE MIXTURE, STABILIZED (Propadiene with 1% to 4% methylacetylene)	2.1			X	X	X	X	X	10	22	0.52	c
1061	METHYLAMINE, ANHYDROUS	2.1			X	X	X	X	X	10	13	0.58	b
1062	METHYL BROMIDE with not more than 2% chloropicrin	2.3		850	X	X	X	X	X	5	10	1.51	a
1063	METHYL CHLORIDE (REFRIGERANT GAS R 40)	2.1			X	X	X	X	X	10	17	0.81	a
1064	METHYL MERCAPTAN	2.3	2.1	1350	X	X	X	X	X	5	10	0.78	d, u
1067	DINITROGEN TETROXIDE (NITROGEN DIOXIDE)	2.3	5.1, 8	115	X		X	X		5	10	1.30	k
1069	NITROSYL CHLORIDE	2.3	8	35	X			X		5	13	1.10	k
1070	NITROUS OXIDE	2.2	5.1		X	X	X	X	X	10	180 225 250	0.68 0.74 0.75	
1075	PETROLEUM GASES, LIQUEFIED	2.1			X	X	X	X	X	10			v, z
1076	PHOSGENE	2.3	8	5	X		X	X		5	20	1.23	k, a
1077	PROPYLENE	2.1			X	X	X	X	X	10	27	0.43	
1078	REFRIGERANT GAS, N.O.S.	2.2			X	X	X	X	X	10			z
1079	SULPHUR DIOXIDE	2.3	8	2520	X	X	X	X	X	5	12	1.23	
1080	SULPHUR HEXAFLUORIDE	2.2			X	X	X	X	X	10	70 140 160	1.06 1.34 1.38	
1081	TETRAFLUROETHYLENE, STABILIZED	2.1			X	X	X	X	X	10	200		m, o
1082	TRIFLUOROCHLOROETHYLENE, STABILIZED	2.3	2.1	2000	X	X	X	X	X	5	19	1.13	u
1083	TRIMETHYLAMINE, ANHYDROUS	2.1			X	X	X	X	X	10	10	0.56	b
1085	VINYL BROMIDE, STABILIZED	2.1			X	X	X	X	X	10	10	1.37	a
1086	VINYL CHLORIDE, STABILIZED	2.1			X	X	X	X	X	10	12	0.81	a
1087	VINYL METHYL ETHER, STABILIZED	2.1			X	X	X	X	X	10	10	0.67	
1581	CHLOROPICRIN AND METHYL BROMIDE MIXTURE with more than 2% chloropicrin	2.3		850	X	X	X	X	X	5	10	1.51	a
1582	CHLOROPICRIN AND METHYL CHLORIDE MIXTURE	2.3			X	X	X	X	X	5	17	0.81	a

<sup>a</sup>Where the entries are blank, the maximum working pressure shall not exceed two thirds of the test pressure.

Part 4 – Packing and tank provisions

P200 PACKING INSTRUCTION (continued) P200													
Table 2: LIQUEFIED GASES AND DISSOLVED GASES (continued)													
UN No.	Proper Shipping Name	Class	Subsidiary risk	LC <sub>50</sub> , ml/m <sup>3</sup>	Cylinders	Tubes	Pressure drums	Bundles of cylinders	MEGCs	Test period, years	Test pressure, bar*	Filling ratio	Special packing provisions
1589	CYANOGEN CHLORIDE, STABILIZED	2.3	8	80	X			X		5	20	1.03	k
1741	BORON TRICHLORIDE	2.3	8	2541	X	X	X	X	X	5	10	1.19	a
1749	CHLORINE TRIFLUORIDE	2.3	5.1, 8	299	X	X	X	X	X	5	30	1.40	a
1858	HEXAFLUOROPROPYLENE (REFRIGERANT GAS R 1216)	2.2			X	X	X	X	X	10	22	1.11	
1859	SILICON TETRAFLUORIDE	2.3	8	450	X	X	X	X	X	5	200 300	0.74 1.10	a
1860	VINYL FLUORIDE, STABILIZED	2.1			X	X	X	X	X	10	250	0.64	a
1911	DIBORANE	2.3	2.1	80	X			X		5	250	0.07	d, k, o
1912	METHYL CHLORIDE AND METHYLENE CHLORIDE MIXTURE	2.1			X	X	X	X	X	10	17	0.81	a
1952	ETHYLENE OXIDE AND CARBON DIOXIDE MIXTURE with not more than 9% ethylene oxide	2.2			X	X	X	X	X	10	190 250	0.66 0.75	
1958	1,2-DICHLORO-1,1,2,2-TETRAFLUOROETHANE (REFRIGERANT GAS R 114)	2.2			X	X	X	X	X	10	10	1.30	
1959	1,1-DIFLUOROETHYLENE (REFRIGERANT GAS R 1132a)	2.1			X	X	X	X	X	10	250	0.77	
1962	ETHYLENE	2.1			X	X	X	X	X	10	225 300	0.34 0.38	
1965	HYDROCARBON GAS MIXTURE, LIQUEFIED, N.O.S.	2.1			X	X	X	X	X	10			v, z
1967	INSECTICIDE GAS, TOXIC, N.O.S.	2.3			X	X	X	X	X	5			z
1968	INSECTICIDE GAS, N.O.S.	2.2			X	X	X	X	X	10			z
1969	ISOBUTANE	2.1			X	X	X	X	X	10	10	0.49	v
1973	CHLORODIFLUOROMETHANE AND CHLOROPENTAFLUROETHANE MIXTURE with fixed boiling point, with approximately 49% chlorodifluoromethane (REFRIGERANT GAS R 502)	2.2			X	X	X	X	X	10	31	1.01	
1974	CHLORODIFLUOROBROMOMETHANE (REFRIGERANT GAS R 12B1)	2.2			X	X	X	X		10	10	1.61	
1975	NITRIC OXIDE AND DINITROGEN TETROXIDE MIXTURE (NITRIC OXIDE AND NITROGEN DIOXIDE MIXTURE)	2.3	5.1, 8	115	X		X	X		5			k, z
1976	OCTAFLUOROCYCLOBUTANE (REFRIGERANT GAS RC 318)	2.2			X	X	X	X	X	10	11	1.32	
1978	PROPANE	2.1			X	X	X	X	X	10	23	0.43	v
1982	TETRAFLUOROMETHANE (REFRIGERANT GAS R 14)	2.2			X	X	X	X	X	10	200 300	0.71 0.90	
1983	1-CHLORO-2,2,2-TRIFLUOROETHANE (REFRIGERANT GAS R 133a)	2.2			X	X	X	X	X	10	10	1.18	
1984	TRIFLUOROMETHANE (REFRIGERANT GAS R 23)	2.2			X	X	X	X	X	10	190 250	0.88 0.96	
2035	1,1,1-TRIFLUOROETHANE (REFRIGERANT GAS R 143a)	2.1			X	X	X	X	X	10	35	0.73	
2036	XENON	2.2			X	X	X	X	X	10	130	1.28	
2044	2,2-DIMETHYLPROPANE	2.1			X	X	X	X	X	10	10	0.53	

\* Where the entries are blank, the maximum working pressure shall not exceed two thirds of the test pressure.



Chapter 4.1 – Use of packagings, including IBCs and large packagings

P200 PACKING INSTRUCTION (continued) P200													
Table 2: LIQUEFIED GASES AND DISSOLVED GASES (continued)													
UN No.	Proper Shipping Name	Class	Subsidiary risk	LC <sub>50</sub> , ml/m <sup>3</sup>	Cylinders	Tubes	Pressure drums	Bundles of cylinders	MEGCs	Test period, years	Test pressure, bar <sup>a</sup>	Filling ratio	Special packing provisions
2073	AMMONIA SOLUTION, relative density less than 0.880 at 15°C in water, with more than 35% but not more than 40% ammonia with more than 40% but not more than 50% ammonia	2.2			X	X	X	X	X	5	10	0.80	b
					X	X	X	X	X	5	12	0.77	b
2188	ARSINE	2.3	2.1	20	X			X		5	42	1.10	d, k
2189	DICHLOROSILANE	2.3	2.1, 8	314	X	X	X	X	X	5	10	0.90	a
										200	1.08		
2191	SULPHURYL FLUORIDE	2.3		3020	X	X	X	X	X	5	50	1.10	u
2192	GERMANE	2.3	2.1	620	X	X	X	X	X	5	250	0.064	d, q, r
2193	HEXAFLUOROETHANE (REFRIGERANT GAS R 116)	2.2			X	X	X	X	X	10	200	1.13	
2194	SELENIUM HEXAFLUORIDE	2.3	8	50	X			X		5	36	1.46	k
2195	TELLURIUM HEXAFLUORIDE	2.3	8	25	X			X		5	20	1.00	k
2196	TUNGSTEN HEXAFLUORIDE	2.3	8	160	X			X		5	10	3.08	a, k
2197	HYDROGEN IODIDE, ANHYDROUS	2.3	8	2860	X	X	X	X	X	5	23	2.25	a, d
2198	PHOSPHORUS PENTAFLUORIDE	2.3	8	190	X			X		5	200	0.90	k
										300	1.25	k	
2199	PHOSPHINE	2.3	2.1	20	X			X		5	225	0.30	d, k, q
										250	0.45	d, k, q	
2200	PROPADIENE, STABILIZED	2.1			X	X	X	X	X	10	22	0.50	
2202	HYDROGEN SELENIDE, ANHYDROUS	2.3	2.1	2	X			X		5	31	1.60	k
2203	SILANE	2.1			X	X	X	X	X	10	225	0.32	q
										250	0.36	q	
2204	CARBONYL SULPHIDE	2.3	2.1	1700	X	X	X	X	X	5	30	0.87	u
2417	CARBONYL FLUORIDE	2.3	8	360	X	X	X	X	X	5	200	0.47	
										300	0.70		
2418	SULPHUR TETRAFLUORIDE	2.3	8	40	X			X		5	30	0.91	k, a
2419	BROMOTRIFLUOROETHYLENE	2.1			X	X	X	X	X	10	10	1.19	
2420	HEXAFLUOROACETONE	2.3	8	470	X	X	X	X	X	5	22	1.08	
2421	NITROGEN TRIOXIDE	2.3	5.1, 8	57	X			X		5			k
2422	OCTAFLUOROBUT-2-ENE (REFRIGERANT GAS R 1318)	2.2			X	X	X	X	X	10	12	1.34	
2424	OCTAFLUOROPROPANE (REFRIGERANT GAS R 218)	2.2			X	X	X	X	X	10	25	1.04	
2451	NITROGEN TRIFLUORIDE	2.2	5.1		X	X	X	X	X	10	200	0.50	
2452	ETHYLACETYLENE, STABILIZED	2.1			X	X	X	X	X	10	10	0.57	c
2453	ETHYL FLUORIDE (REFRIGERANT GAS R 161)	2.1			X	X	X	X	X	10	30	0.57	
2454	METHYL FLUORIDE (REFRIGERANT GAS R 41)	2.1			X	X	X	X	X	10	300	0.63	
2455	METHYL NITRITE	2.2			(see special provision 900)								
2517	1-CHLORO-1,1-DIFLUOROETHANE (REFRIGERANT GAS R 142b)	2.1			X	X	X	X	X	10	10	0.99	
2534	METHYLCHLOROSILANE	2.3	2.1, 8	600	X	X	X	X	X	5			z
2548	CHLORINE PENTAFLUORIDE	2.3	5.1, 8	122	X			X		5	13	1.49	a, k

<sup>a</sup> Where the entries are blank, the maximum working pressure shall not exceed two thirds of the test pressure.

Part 4 – Packing and tank provisions

P200		PACKING INSTRUCTION (continued)										P200	
Table 2: LIQUEFIED GASES AND DISSOLVED GASES (continued)													
UN No.	Proper Shipping Name	Class	Subsidiary risk	LC <sub>50</sub> , ml/m <sup>3</sup>	Cylinders	Tubes	Pressure drums	Bundles of cylinders	MEGCs	Test period, years	Test pressure, bar <sup>a</sup>	Filling ratio	Special packing provisions
2599	CHLOROTRIFLUOROMETHANE AND TRIFLUOROMETHANE AZEOTROPIC MIXTURE with approximately 60% chlorotrifluoromethane (REFRIGERANT GAS R 503)	2.2			X	X	X	X	X	10	31 42 100	0.12 0.17 0.64	
2601	CYCLOBUTANE	2.1			X	X	X	X	X	10	10	0.63	
2602	DICHLORODIFLUOROMETHANE AND DIFLUOROETHANE AZEOTROPIC MIXTURE with approximately 74% dichlorodifluoromethane (REFRIGERANT GAS R 500)	2.2			X	X	X	X	X	10	22	1.01	
2676	STIBINE	2.3	2.1	20	X			X		5	200	0.49	k, r
2901	BROMINE CHLORIDE	2.3	5.1, 8	290	X	X	X	X	X	5	10	1.50	a
3057	TRIFLUOROACETYL CHLORIDE	2.3	8	10	X		X	X		5	17	1.17	k
3070	ETHYLENE OXIDE AND DICHLORODIFLUOROMETHANE MIXTURE with not more than 12.5% ethylene oxide	2.2			X	X	X	X	X	10	18	1.09	
3083	PERCHLORYL FLUORIDE	2.3	5.1	770	X	X	X	X	X	5	33	1.21	u
3153	PERFLUORO(METHYL VINYL ETHER)	2.1			X	X	X	X	X	10	20	0.75	
3154	PERFLUORO(ETHYL VINYL ETHER)	2.1			X	X	X	X	X	10	10	0.98	
3157	LIQUEFIED GAS, OXIDIZING, N.O.S.	2.2	5.1		X	X	X	X	X	10			z
3159	1,1,1,2-TETRAFLUOROETHANE (REFRIGERANT GAS R 134a)	2.2			X	X	X	X	X	10	18	1.05	
3160	LIQUEFIED GAS, TOXIC, FLAMMABLE, N.O.S.	2.3	2.1	≤ 5000	X	X	X	X	X	5			z
3161	LIQUEFIED GAS, FLAMMABLE, N.O.S.	2.1			X	X	X	X	X	10			z
3162	LIQUEFIED GAS, TOXIC, N.O.S.	2.3		≤ 5000	X	X	X	X	X	5			z
3163	LIQUEFIED GAS, N.O.S.	2.2			X	X	X	X	X	10			z
3220	PENTAFLUOROETHANE (REFRIGERANT GAS R 125)	2.2			X	X	X	X	X	10	49 35	0.95 0.87	
3252	DIFLUOROMETHANE (REFRIGERANT GAS R 32)	2.1			X	X	X	X	X	10	48	0.78	
3296	HEPTAFLUOROPROPANE (REFRIGERANT GAS R 227)	2.2			X	X	X	X	X	10	13	1.21	
3297	ETHYLENE OXIDE AND CHLOROTETRAFLUOROETHANE MIXTURE with not more than 8.8% ethylene oxide	2.2			X	X	X	X	X	10	10	1.16	
3298	ETHYLENE OXIDE AND PENTAFLUOROETHANE MIXTURE with not more than 7.9% ethylene oxide	2.2			X	X	X	X	X	10	26	1.02	
3299	ETHYLENE OXIDE AND TETRAFLUOROETHANE MIXTURE with not more than 5.6% ethylene oxide	2.2			X	X	X	X	X	10	17	1.03	
3300	ETHYLENE OXIDE AND CARBON DIOXIDE MIXTURE with more than 87% ethylene oxide	2.3	2.1	More than 2900	X	X	X	X	X	5	28	0.73	
3307	LIQUEFIED GAS, TOXIC, OXIDIZING, N.O.S.	2.3	5.1	≤ 5000	X	X	X	X	X	5			z
3308	LIQUEFIED GAS, TOXIC, CORROSIVE, N.O.S.	2.3	8	≤ 5000	X	X	X	X	X	5			z
3309	LIQUEFIED GAS, TOXIC, FLAMMABLE, CORROSIVE, N.O.S.	2.3	2.1, 8	≤ 5000	X	X	X	X	X	5			z
3310	LIQUEFIED GAS, TOXIC, OXIDIZING, CORROSIVE, N.O.S.	2.3	5.1, 8	≤ 5000	X	X	X	X	X	5			z
3318	AMMONIA SOLUTION, relative density less than 0.880 at 15°C in water, with more than 50% ammonia	2.3	8		X	X	X	X		5			b
3337	REFRIGERANT GAS R 404A	2.2			X	X	X	X	X	10	36	0.82	

<sup>a</sup> Where the entries are blank, the maximum working pressure shall not exceed two thirds of the test pressure.

Chapter 4.1 – Use of packagings, including IBCs and large packagings

P200		PACKING INSTRUCTION (continued)										P200	
Table 2: LIQUEFIED GASES AND DISSOLVED GASES (continued)													
UN No.	Proper Shipping Name	Class	Subsidiary risk	LC <sub>50</sub> , m <sup>3</sup> /m <sup>3</sup>	Cylinders	Tubes	Pressure drums	Bundles of cylinders	MEGCs	Test period, years	Test pressure, bar <sup>a</sup>	Filling ratio	Special packing provisions
3338	REFRIGERANT GAS R 407A	2.2			X	X	X	X	X	10	32	0.94	
3339	REFRIGERANT GAS R 407B	2.2			X	X	X	X	X	10	33	0.93	
3340	REFRIGERANT GAS R 407C	2.2			X	X	X	X	X	10	30	0.95	
3354	INSECTICIDE GAS, FLAMMABLE, N.O.S.	2.1			X	X	X	X	X	10			z
3355	INSECTICIDE GAS, TOXIC, FLAMMABLE, N.O.S.	2.3	2.1		X	X	X	X	X	5			z
3374	ACETYLENE, SOLVENT FREE	2.1			X			X		5	60 52		c, p

<sup>a</sup> Where the entries are blank, the maximum working pressure shall not exceed two thirds of the test pressure.

P200		PACKING INSTRUCTION (continued)										P200	
Table 3: SUBSTANCES NOT IN CLASS 2													
UN No.	Proper Shipping Name	Class	Subsidiary risk	LC <sub>50</sub> , m <sup>3</sup> /m <sup>3</sup>	Cylinders	Tubes	Pressure drums	Bundles of cylinders	MEGCs	Test period, years	Test pressure, bar <sup>a</sup>	Filling ratio	Special packing provisions
1051	HYDROGEN CYANIDE, STABILIZED containing less than 3% water	6.1	3	40	X			X		5	100	0.55	k
1052	HYDROGEN FLUORIDE, ANHYDROUS	8	6.1	966	X		X	X		5	10	0.84	t, a
1745	BROMINE PENTAFLUORIDE	5.1	6.1, 8	25	X		X	X		5	10	†	k
1746	BROMINE TRIFLUORIDE	5.1	6.1, 8	50	X		X	X		5	10	†	k
2495	IODINE PENTAFLUORIDE	5.1	6.1, 8	120	X		X	X		5	10	†	k
2983	ETHYLENE OXIDE AND PROPYLENE OXIDE MIXTURE with not more than 30% ethylene oxide	3	6.1		X		X	X		5	10		z

<sup>a</sup> Where the entries are blank, the maximum working pressure shall not exceed two thirds of the test pressure.

† A minimum ullage of 8% by volume is required.

P201		PACKING INSTRUCTION										P201	
This instruction applies to UN 3167, UN 3168 and UN 3169.													
The following packagings are authorized:													
(1) Cylinders and gas receptacles conforming to the construction, testing and filling requirements approved by the competent authority.													
(2) The following combination packagings provided that the general provisions of 4.1.1 and 4.1.3 are met:													
Outer packagings:													
Drums (1A1, 1A2, 1B1, 1B2, 1N1, 1N2, 1H1, 1H2, 1D, 1G);													
Boxes (4A, 4B, 4N, 4C1, 4C2, 4D, 4F, 4G, 4H1, 4H2);													
Jerricans (3A1, 3A2, 3B1, 3B2, 3H1, 3H2).													
Inner packagings:													
(a) For non-toxic gases, hermetically sealed inner packagings of glass or metal with a maximum capacity of 5ℓ per package;													
(b) For toxic gases, hermetically sealed inner packagings of glass or metal with a maximum capacity of 1ℓ per package.													
Packagings shall conform to the packing group III performance level.													

Part 4 – Packing and tank provisions

P202	PACKING INSTRUCTION	P202
[Reserved]		
P203	PACKING INSTRUCTION	P203
This instruction applies to class 2 refrigerated liquefied gases.		
<p><b>Requirements for closed cryogenic receptacles:</b></p> <p>(1) The general requirements of 4.1.6.1 shall be met.</p> <p>(2) The requirements of chapter 6.2 shall be met.</p> <p>(3) The closed cryogenic receptacles shall be so insulated that they do not become coated with frost.</p> <p>(4) Test pressure Refrigerated liquids shall be filled in closed cryogenic receptacles with the following minimum test pressures:</p> <p>(a) For closed cryogenic receptacles with vacuum insulation, the test pressure shall not be less than 1.3 times the sum of the maximum internal pressure of the filled receptacle, including during filling and discharge, plus 100 kPa (1 bar);</p> <p>(b) For other closed cryogenic receptacles, the test pressure shall be not less than 1.3 times the maximum internal pressure of the filled receptacle, taking into account the pressure developed during filling and discharge.</p> <p>(5) Degree of filling For non-flammable, non-toxic refrigerated liquefied gases the volume of liquid phase at the filling temperature and at a pressure of 100 kPa (1 bar) shall not exceed 98% of the water capacity of the pressure receptacle. For flammable refrigerated liquefied gases the degree of filling shall remain below the level at which, if the contents were raised to the temperature at which the vapour pressure equalled the opening pressure of the relief valve, the volume of the liquid phase would reach 98% of the water capacity at that temperature.</p> <p>(6) Pressure-relief devices Closed cryogenic receptacles shall be fitted with at least one pressure-relief device.</p> <p>(7) Compatibility Materials used to ensure the leakproofness of the joints or for the maintenance of the closures shall be compatible with the contents. In the case of receptacles intended for the transport of oxidizing gases (i.e. with a subsidiary risk of 5.1), these materials shall not react with these gases in a dangerous manner.</p> <p>(8) Periodic inspection The periodic inspection and test frequencies of pressure relief valves in accordance with 6.2.1.6.3 shall not exceed five years.</p> <p><b>Requirements for open cryogenic receptacles:</b></p> <p>Only the following non-oxidizing refrigerated liquefied gases of class 2.2 may be transported in open cryogenic receptacles: UN 1913, 1951, 1963, 1970, 1977, 2591, 3136 and 3158. Open cryogenic receptacles shall be constructed to meet the following requirements:</p> <p>(1) The receptacles shall be designed, manufactured, tested and equipped in such a way as to withstand all conditions, including fatigue, to which they will be subjected during their normal use and during normal conditions of transport.</p> <p>(2) The capacity shall be not more than 450 litres.</p> <p>(3) The receptacle shall have a double wall construction with the space between the inner and outer wall being evacuated (vacuum insulation). The insulation shall prevent the formation of hoar frost on the exterior of the receptacle.</p> <p>(4) The materials of construction shall have suitable mechanical properties at the service temperature.</p> <p>(5) Materials which are in direct contact with the dangerous goods shall not be affected or weakened by the dangerous goods intended to be transported and shall not cause a dangerous effect, e.g., catalysing a reaction or reacting with the dangerous goods.</p> <p>(6) Receptacles of glass double wall construction shall have an outer packaging with suitable cushioning or absorbent materials which withstand the pressures and impacts liable to occur under normal conditions of transport.</p> <p>(7) The receptacle shall be designed to remain in an upright position during transport, e.g., have a base whose smaller horizontal dimension is greater than the height of the centre of gravity when filled to capacity or be mounted on gimbals.</p> <p>(8) The openings of the receptacles shall be fitted with devices allowing gases to escape, preventing any splashing out of liquid, and so configured that they remain in place during transport.</p> <p>(9) Open cryogenic receptacles shall bear the following marks permanently affixed, e.g., by stamping, engraving or etching:</p> <ul style="list-style-type: none"> <li>– The manufacturer's name and address;</li> <li>– The model number or name;</li> <li>– The serial or batch number;</li> <li>– The UN Number and Proper Shipping Name of gases for which the receptacle is intended;</li> <li>– The capacity of the receptacle in litres.</li> </ul>		

P205	PACKING INSTRUCTION	P205				
This instruction applies to UN 3468.						
<p>(1) For metal hydride storage systems, the general packing requirements of 4.1.6.1 shall be met.</p> <p>(2) Only pressure receptacles not exceeding 150 litres in water capacity and having a maximum developed pressure not exceeding 25 MPa are covered by this packing instruction.</p> <p>(3) Metal hydride storage systems meeting the applicable requirements for the construction and testing of pressure receptacles containing gas of chapter 6.2 are authorized for the transport of hydrogen only.</p> <p>(4) When steel pressure receptacles or composite pressure receptacles with steel liners are used, only those bearing the "H" mark, in accordance with 6.2.2.9.2(j), shall be used.</p> <p>(5) Metal hydride storage systems shall meet the service conditions, design criteria, rated capacity, type tests, batch tests, routine tests, test pressure, rated charging pressure and provisions for pressure relief devices for transportable metal hydride storage systems specified in ISO 16111:2008 and their conformity and approval shall be assessed in accordance with 6.2.2.5.</p> <p>(6) Metal hydride storage systems shall be filled with hydrogen at a pressure not exceeding the rated charging pressure shown in the permanent markings on the system as specified by ISO 16111:2008.</p> <p>(7) The periodic test requirements for a metal hydride storage system shall be in accordance with ISO 16111:2008 and carried out in accordance with 6.2.2.6, and the interval between periodic inspections shall not exceed five years.</p>						
P206	PACKING INSTRUCTION	P206				
This instruction applies to UN Nos. 3500, 3501, 3502, 3503, 3504 and 3505.						
<p>Unless otherwise indicated in these provisions, cylinders and pressure drums conforming to the applicable requirements of Chapter 6.2 are authorized.</p> <p>(1) The general packing requirements of 4.1.6.1 shall be met.</p> <p>(2) The maximum test period for periodic inspection shall be 5 years.</p> <p>(3) Cylinders and pressure drums shall be so filled that at 50 °C the non-gaseous phase does not exceed 95% of their water capacity and they are not completely filled at 60 °C. When filled, the internal pressure at 65 °C shall not exceed the test pressure of the cylinders and pressure drums. The vapour pressures and volumetric expansion of all substances in the cylinders and pressure drums shall be taken into account.</p> <p>(4) The minimum test pressure shall be in accordance with P200 for the propellant but shall not be less than 20 bar.</p> <p><i>Additional requirement:</i> Cylinders and pressure drums shall not be offered for transport when connected with spray application equipment such as a hose and wand assembly.</p> <p><i>Special packing provision:</i> PP89 For UN 3501, 3502, 3503, 3504 and 3505, notwithstanding 4.1.6.1.9.2, non-refillable cylinders used may have a water capacity in ℓ not exceeding 1 000 litres divided by the test pressure expressed in bars provided capacity and pressure restrictions of the construction standard comply with ISO 11118:1999, which limits the maximum capacity to 50 ℓ.</p>						
P207	PACKING INSTRUCTION	P207				
This instruction applies to UN No. 1950..						
<p>The following packagings are authorized, provided that the general provisions of 4.1.1 and 4.1.3 are met:</p> <p>(a) Drums (1A1, 1A2, 1B1, 1B2, 1N1, 1N2, 1H1, 1H2, 1D, 1G); Boxes (4A, 4B, 4N, 4C1, 4C2, 4D, 4F, 4G, 4H1, 4H2). Packagings shall conform to the packing group II performance level.</p> <p>(b) Rigid outer packagings with a maximum net mass as follows:</p> <table style="margin-left: 20px;"> <tr> <td>Fibreboard</td> <td>55 kg</td> </tr> <tr> <td>Other than fibreboard</td> <td>125 kg</td> </tr> </table> <p>The provisions of 4.1.1.3 need not be met.</p> <p>The packagings shall be designed and constructed to prevent movement of the aerosols and inadvertent discharge during normal conditions of transport.</p> <p><i>Special packing provision:</i> PP87 For UN 1950 waste aerosols transported in accordance with special provision 327, the packagings shall have a means of retaining any free liquid that might escape during transport, e.g., absorbent material. The packaging shall be adequately ventilated to prevent the creation of flammable atmosphere and the build-up of pressure.</p>			Fibreboard	55 kg	Other than fibreboard	125 kg
Fibreboard	55 kg					
Other than fibreboard	125 kg					

Part 4 – Packing and tank provisions

P300	PACKING INSTRUCTION	P300
This instruction applies to UN 3064.		
The following packagings are authorized, provided that the general provisions of 4.1.1 and 4.1.3 are met: Combination packagings consisting of inner metal cans of not more than 1 ℓ capacity each and outer wooden boxes (4C1, 4C2, 4D or 4F) containing not more than 5 ℓ of solution.		
<b>Additional provisions:</b>		
<ol style="list-style-type: none"> <li>1 Metal cans shall be completely surrounded with absorbent cushioning material.</li> <li>2 Wooden boxes shall be completely lined with suitable material impervious to water and nitroglycerin.</li> </ol>		

P301	PACKING INSTRUCTION	P301
This instruction applies to UN 3165.		
The following packagings are authorized, provided that the general provisions of 4.1.1 and 4.1.3 are met:		
(1) Aluminium pressure receptacle made from tubing and having welded heads Primary containment of the fuel within this receptacle shall consist of a welded aluminium bladder having a maximum internal volume of 46 ℓ. The outer receptacle shall have a minimum design gauge pressure of 1,275 kPa and a minimum burst gauge pressure of 2,755 kPa. Each receptacle shall be leak-checked during manufacture and before shipment and shall be found leakproof. The complete inner unit shall be securely packed in non-combustible cushioning material, such as vermiculite, in a strong outer tightly closed metal packaging which will adequately protect all fittings. Maximum quantity of fuel per unit and package is 42 ℓ.		
(2) Aluminium pressure receptacle Primary containment of the fuel within this receptacle shall consist of a welded vapourtight fuel compartment with an elastomeric bladder having a maximum internal volume of 46 ℓ. The pressure receptacle shall have a minimum design gauge pressure of 2,680 kPa and a minimum burst pressure of 5,170 kPa. Each receptacle shall be leak-checked during manufacture and before shipment and shall be securely packed in non-combustible cushioning material such as vermiculite, in a strong outer tightly closed metal packaging which will adequately protect all fittings. Maximum quantity of fuel per unit and package is 42 ℓ.		

P302	PACKING INSTRUCTION	P302
This instruction applies to UN 3269.		
The following combination packagings are authorized, provided that the general provisions of 4.1.1 and 4.1.3 are met:		
Outer packagings:		
Drums (1A1, 1A2, 1B1, 1B2, 1N1, 1N2, 1H1, 1H2, 1D, 1G).		
Boxes (4A, 4B, 4N, 4C1, 4C2, 4D, 4F, 4G, 4H1, 4H2).		
Jerricans (3A1, 3A2, 3B1, 3B2, 3H1, 3H2).		
Inner packagings:		
The activator (organic peroxide) shall have a maximum quantity of 125 ml per inner packaging if liquid, and 500 g per inner packaging if solid.		
The base material and the activator shall be each separately packed in inner packagings.		
The components may be placed in the same outer packaging provided that they will not interact dangerously in the event of a leakage.		
Packagings shall conform to the packing group II or III performance level according to the criteria for Class 3 applied to the base material.		

Chapter 4.1 – Use of packagings, including IBCs and large packagings

P400	PACKING INSTRUCTION	P400
<p>The following packagings are authorized, provided that the general provisions of 4.1.1 and 4.1.3 are met:</p> <p>(1) Pressure receptacles, provided that the general provisions of 4.1.3.6 are met. They shall be made of steel and shall be subjected to an initial test and periodic tests every 10 years at a pressure of not less than 1 MPa (10 bar, gauge pressure). During carriage, the liquid shall be under a layer of inert gas with a gauge pressure of not less than 20 kPa (0.2 bar).</p> <p>(2) Boxes (4A, 4B, 4N, 4C1, 4C2, 4D, 4F or 4G), drums (1A1, 1A2, 1B1, 1B2, 1N1, 1N2, 1D or 1G) or jerricans (3A1, 3A2, 3B1 or 3B2) enclosing hermetically sealed metal cans with inner packagings of glass or metal, with a capacity of not more than 1 ℓ each, having threaded closures with gaskets. Inner packagings shall be cushioned on all sides with dry, absorbent, non-combustible material in a quantity sufficient to absorb the entire contents. Inner packagings shall not be filled to more than 90% of their capacity. Outer packagings shall have a maximum net mass of 125 kg.</p> <p>(3) Steel, aluminium or metal drums (1A1, 1A2, 1B1, 1B2, 1N1 or 1N2), jerricans (3A1, 3A2, 3B1 or 3B2) or boxes (4A, 4B or 4N) with a maximum net mass of 150 kg each with hermetically sealed inner metal cans of not more than 4 ℓ capacity each, with threaded closures fitted with gaskets. Inner packagings shall be cushioned on all sides with dry, absorbent, non-combustible material in a quantity sufficient to absorb the entire contents. Each layer of inner packagings shall be separated by a dividing partition in addition to cushioning material. Inner packagings shall not be filled to more than 90% of their capacity.</p>		
<p><b>Special packing provision:</b>  <b>PP86</b> For UN 3392 and UN 3394, air shall be eliminated from the vapour space by nitrogen or other means.</p>		

P401	PACKING INSTRUCTION	P401
<p>The following packagings are authorized, provided that the general provisions of 4.1.1 and 4.1.3 are met:</p> <p>(1) Pressure receptacles, provided that the general provisions of 4.1.3.6 are met. They shall be made of steel and subjected to an initial test and periodic tests every 10 years at a pressure of not less than 0.6 MPa (6 bar, gauge pressure). During carriage, the liquid shall be under a layer of inert gas with a gauge pressure of not less than 20 kPa (0.2 bar).</p> <p>(2) Combination packagings            Outer packagings:                Drums (1A1, 1A2, 1B1, 1B2, 1N1, 1N2, 1H1, 1H2, 1D, 1G);                Boxes (4A, 4B, 4N, 4C1, 4C2, 4D, 4F, 4G, 4H1,4H2);                Jerricans (3A1, 3A2, 3B1, 3B2, 3H1, 3H2).            Inner packagings:                Glass, metal or plastics which have threaded closures with a maximum capacity of 1 ℓ.            Each inner packaging shall be surrounded by inert cushioning and absorbent material in a quantity sufficient to absorb the entire contents.            The maximum net mass per outer packaging shall not exceed 30 kg.</p>		
<p><b>Special packing provision:</b>  <b>PP31</b> For UN Nos. 1183, 1242, 1295, 2965 and 2988, packagings shall be hermetically sealed.</p>		

## Part 4 – Packing and tank provisions

P402	PACKING INSTRUCTION	P402
<p>The following packagings are authorized, provided that the general provisions of 4.1.1 and 4.1.3 are met:</p> <p>(1) Pressure receptacles, provided that the general provisions of 4.1.3.6 are met. They shall be made of steel and subjected to an initial test and periodic tests every 10 years at a pressure of not less than 0.6 MPa (6 bar, gauge pressure). During carriage, the liquid shall be under a layer of inert gas with a gauge pressure of not less than 20 kPa (0.2 bar).</p> <p>(2) Combination packagings</p> <p>Outer packagings:</p> <p>Drums (1A1, 1A2, 1B1, 1B2, 1N1, 1N2, 1H1, 1H2, 1D, 1G); Boxes (4A, 4B, 4N, 4C1, 4C2, 4D, 4F, 4G, 4H1, 4H2); Jerricans (3A1, 3A2, 3B1, 3B2, 3H1, 3H2).</p> <p>Inner packagings with a maximum net mass as follows:</p> <p>Glass 10 kg Metal or plastics 15 kg</p> <p>Each inner packaging shall be fitted with threaded closures. Each inner packaging shall be surrounded by inert cushioning and absorbent material in a quantity sufficient to absorb the entire contents. The maximum net mass per outer packaging shall not exceed 125 kg.</p> <p>(3) Steel drums (1A1) with a maximum capacity of 250 ℓ.</p> <p>(4) Composite packagings consisting of plastics receptacle in a steel or aluminium drum (6HA1 or 6HB1) with a maximum capacity of 250 ℓ.</p>		
<p><b>Special packing provision:</b> <b>PP31</b> For UN Nos.1389, 1391, 1392, 1420, 1421, 1422, 3148, 3184 (PG II), 3185 (PG II), 3187 (PG II), 3188 (PG II), 3398 (PG I), 3399 (PG I) and 3482, packagings shall be hermetically sealed.</p>		



Chapter 4.1 – Use of packagings, including IBCs and large packagings

P403		PACKING INSTRUCTION		P403
The following packagings are authorized, provided that the general provisions of 4.1.1 and 4.1.3 are met:				
Combination packagings			Maximum net mass	
Inner packagings	Outer packagings			
Glass	2 kg	<b>Drums</b>		
Plastic	15 kg	steel (1A1, 1A2)		400 kg
Metal	20 kg	aluminium (1B1, 1B2)		400 kg
		other metal (1N1, 1N2)		400 kg
Inner packagings shall be hermetically sealed (e.g., by taping or by threaded closures).		plastics (1H1, 1H2)		400 kg
		plywood (1D)		400 kg
		fibre (1G)		400 kg
		<b>Boxes</b>		
		steel (4A)		400 kg
		aluminium (4B)		400 kg
		other metal (4N)		400 kg
		natural wood (4C1)		250 kg
		natural wood with sift-proof walls (4C2)		250 kg
		plywood (4D)		250 kg
		reconstituted wood (4F)		125 kg
		fibreboard (4G)		125 kg
		expanded plastics (4H1)		60 kg
		solid plastics (4H2)		250 kg
		<b>Jerricans</b>		
		steel (3A1, 3A2)		120 kg
		aluminium (3B1, 3B2)		120 kg
		plastics (3H1, 3H2)		120 kg
Single packagings				
<b>Drums</b>				
		steel (1A1, 1A2)		250 kg
		aluminium (1B1, 1B2)		250 kg
		metal other than steel or aluminium (1N1, 1N2)		250 kg
		plastics (1H1, 1H2)		250 kg
<b>Jerricans</b>				
		steel (3A1, 3A2)		120 kg
		aluminium (3B1, 3B2)		120 kg
		plastics (3H1, 3H2)		120 kg
<b>Composite packagings</b>				
		Plastics receptacle in steel or aluminium drum (6HA1 or 6HB1)		250 kg
		Plastics receptacle in fibre, plastics or plywood drum (6HG1, 6HH1 or 6HD1)		75 kg
		Plastics receptacle in steel, aluminium, wood, plywood, fibreboard or solid plastics box (6HA2, 6HB2, 6HC, 6HD2, 6HG2 or 6HH2)		75 kg
<b>Pressure receptacles</b> , provided that the general provisions of 4.1.3.6 are met				
<i>Special packing provisions:</i>				
<b>PP31</b> For UN Nos. 1360, 1397, 1402 (PG I), 1404, 1407, 1409, 1410, 1413, 1414, 1415, 1418 (PG I), 1419, 1423, 1426, 1427, 1428, 1432, 1433, 1714, 1870, 2010, 2011, 2012, 2013, 2257, 2463, 2806, 2813 (PG I), 3208, 3209, 3401, 3402, 3403 and 3404, packagings shall be hermetically sealed, except for solid fused material.				
<b>PP83</b> For UN 2813, waterproof bags containing not more than 20 g of substance for the purposes of heat formation may be packaged for transport. Each waterproof bag shall be sealed in a plastics bag and placed within an intermediate packaging. No outer packaging shall contain more than 400 g of substance. Water or liquid which may react with the water-reactive substance shall not be included in the packaging.				

## Part 4 – Packing and tank provisions

P404	PACKING INSTRUCTION	P404
This instruction applies to pyrophoric solids: UN Nos. 1383, 1854, 1855, 2008, 2441, 2545, 2546, 2846, 2881, 3200, 3391 and 3393.		
The following packagings are authorized, provided that the general provisions of 4.1.1 and 4.1.3 are met:		
(1) Combination packagings		
Outer packagings: (1A1, 1A2, 1B1, 1B2, 1N1, 1N2, 1H1, 1H2, 1D, 4A, 4B, 4N, 4C1, 4C2, 4D, 4F or 4H2)		
Inner packagings: Metal packagings with a maximum net mass of 15 kg each. Inner packagings shall be hermetically sealed and have threaded closures.		
(2) Metal packagings: (1A1, 1A2, 1B1, 1N1, 1N2, 3A1, 3A2, 3B1 and 3B2)		
Maximum gross mass: 150 kg		
(3) Composite packagings: Plastics receptacles in a steel or aluminium drum (6HA1 or 6HB1)		
Maximum gross mass: 150 kg		
Pressure receptacles may be used provided that the general provisions of 4.1.3.6 are met.		
<b>Special packing provisions:</b>		
<b>PP31</b> For UN Nos. 1383, 1854, 1855, 2008, 2441, 2545, 2546, 2846, 2881 and 3200, packagings shall be hermetically sealed.		
<b>PP86</b> For UN 3391 and UN 3393, air shall be eliminated from the vapour space by nitrogen or other means.		

P405	PACKING INSTRUCTION	P405
This instruction applies to UN 1381.		
The following packagings are authorized, provided that the general provisions of 4.1.1 and 4.1.3 are met:		
(1) For UN 1381, wet phosphorus:		
.1 Combination packagings		
Outer packagings: (4A, 4B, 4N, 4C1, 4C2, 4D or 4F); maximum net mass: 75 kg		
Inner packagings:		
(i) hermetically sealed metal cans, with a maximum net mass of 15 kg; or		
(ii) glass inner packagings cushioned on all sides with dry, absorbent, non-combustible material in a quantity sufficient to absorb the entire contents with a maximum net mass of 2 kg; or		
.2 Drums (1A1, 1A2, 1B1, 1B2, 1N1 or 1N2); maximum net mass: 400 kg		
Jerricans (3A1 or 3B1); maximum net mass: 120 kg.		
These packagings shall be capable of passing the leakproofness test specified in 6.1.5.4 at the packing group II performance level.		
(2) For UN 1381, dry phosphorus:		
.1 When fused, drums (1A2, 1B2 or 1N2) with a maximum net mass of 400 kg; or		
.2 In projectiles or hard-cased articles when transported without class 1 components, as specified by the competent authority.		
<b>Special packing provision:</b>		
<b>PP31</b> For UN 1381, packagings shall be hermetically sealed.		

Chapter 4.1 – Use of packagings, including IBCs and large packagings

P406	PACKING INSTRUCTION	P406
<p>The following packagings are authorized, provided that the general provisions of 4.1.1 and 4.1.3 are met:</p> <p>(1) Combination packagings Outer packagings: (4C1, 4C2, 4D, 4F, 4G, 4H1, 4H2, 1G, 1D, 1H1, 1H2, 3H1 or 3H2) Inner packagings shall be water-resistant.</p> <p>(2) Plastics, plywood or fibreboard drums (1H2, 1D or 1G) or boxes (4A, 4B, 4N, 4C1, 4D, 4F, 4C2, 4G and 4H2) with a water-resistant inner bag, plastics film lining or water-resistant coating.</p> <p>(3) Metal drums (1A1, 1A2, 1B1, 1B2, 1N1 or 1N2), plastics drums (1H1 or 1H2), metal jerricans (3A1, 3A2, 3B1 or 3B2), plastics jerricans (3H1 or 3H2), plastics receptacle in steel or aluminium drums (6HA1 or 6HB1), plastics receptacle in fibre, plastics or plywood drums (6HG1, 6HH1 or 6HD1), plastics receptacle in steel, aluminium, wood, plywood, fibreboard or solid plastics boxes (6HA2, 6HB2, 6HC, 6HD2, 6HG2 or 6HH2).</p>		
<p><b>Additional provisions:</b></p> <p>1 Packagings shall be designed and constructed to prevent the loss of water or alcohol content or the content of the phlegmatizer.</p> <p>2 Packagings shall be so constructed and closed as to avoid an explosive overpressure or pressure build-up of more than 300 kPa (3 bar).</p> <p>3 The type of packaging and maximum permitted quantity per packaging are limited by the provisions of 2.1.3.4.</p>		
<p><b>Special packing provisions:</b></p> <p>PP24 UN Nos. 2852, 3364, 3365, 3366, 3367, 3368 and 3369 shall not be transported in quantities of more than 500 g per package.</p> <p>PP25 UN 1347 shall not be transported in quantities of more than 15 kg per package.</p> <p>PP26 For UN Nos. 1310, 1320, 1321, 1322, 1344, 1347, 1348, 1349, 1517, 2907, 3317, 3344 and 3376, packagings shall be lead-free.</p> <p>PP31 For UN Nos. 1310, 1320, 1321, 1322, 1336, 1337, 1344, 1347, 1348, 1349, 1354, 1355, 1356, 1357, 1517, 1571, 2555, 2556, 2557, 2852, 3317, 3364, 3365, 3366, 3367, 3368, 3369, 3370 and 3376, packagings shall be hermetically sealed.</p> <p>PP48 For UN 3474, metal packagings shall not be used.</p> <p>PP78 UN 3370 shall not be transported in quantities of more than 11.5 kg per package.</p> <p>PP80 For UN 2907 and UN 3344, packagings shall meet the packing group II performance level. Packagings meeting the test criteria of packing group I shall not be used.</p>		
P407	PACKING INSTRUCTION	P407
<p>This instruction applies to UN Nos. 1331, 1944, 1945 and 2254.</p>		
<p>The following packagings are authorized, provided that the general provisions of 4.1.1 and 4.1.3 are met:</p> <p>Outer packagings: Drums (1A1, 1A2, 1B1, 1B2, 1N1, 1N2, 1H1, 1H2, 1D, 1G); Boxes (4A, 4B, 4N, 4C1, 4C2, 4D, 4F, 4G, 4H1,4 H2); Jerricans (3A1, 3A2, 3B1, 3B2, 3H1, 3H2).</p> <p>Inner packagings: Matches shall be tightly packed in securely closed inner packagings to prevent accidental ignition under normal conditions of transport.</p> <p>The maximum gross mass of the package shall not exceed 45 kg except for fibreboard boxes which shall not exceed 30 kg.</p> <p>Packagings shall conform to the packing group III performance level.</p>		
<p><b>Special packing provision:</b></p> <p>PP27 UN 1331, Strike-anywhere matches, shall not be packed in the same outer packaging with any other dangerous goods other than safety matches or wax Vesta matches, which shall be packed in separate inner packagings. Inner packagings shall not contain more than 700 strike-anywhere matches.</p>		

Part 4 – Packing and tank provisions

P408	PACKING INSTRUCTION	P408
This instruction applies to UN 3292.		
<p>The following packagings are authorized, provided that the general provisions of 4.1.1 and 4.1.3 are met:</p> <p>(1) For cells:                  Drums (1A2, 1B2, 1N2, 1H2, 1D, 1G);                  Boxes (4A, 4B, 4N, 4C1, 4C2, 4D, 4F, 4G, 4H1, 4H2);                  Jerricans (3A2, 3B2, 3H2).</p> <p>There shall be sufficient cushioning material to prevent contact between cells and between cells and the internal surfaces of the outer packaging and to ensure that no dangerous movement of the cells within the outer packaging occurs in transport.  Packagings shall conform to the packing group II performance level.</p> <p>(2) Batteries may be transported unpacked or in protective enclosures (e.g., fully enclosed or wooden slatted crates).  The terminals shall not support the weight of other batteries or materials packed with the batteries.  Packagings need not meet the requirements of 4.1.1.3.</p>		
<b>Additional requirement:</b> Cells and batteries shall be protected against short circuit and shall be isolated in such a manner as to prevent short circuits.		
P409	PACKING INSTRUCTION	P409
This instruction applies to UN Nos. 2956, 3242 and 3251.		
<p>The following packagings are authorized, provided that the general provisions of 4.1.1 and 4.1.3 are met:</p> <p>(1) Fibre drum (1G) which may be fitted with a liner or coating; maximum net mass: 50 kg.  (2) Combination packagings: Fibreboard box (4G) with a single inner plastic bag; maximum net mass: 50 kg.  (3) Combination packagings: Fibreboard box (4G) or fibre drum (1G) with inner plastic packagings each containing a maximum of 5 kg; maximum net mass: 25 kg.</p>		

Chapter 4.1 – Use of packagings, including IBCs and large packagings

P410		PACKING INSTRUCTION		P410
The following packagings are authorized, provided that the general provisions of 4.1.1 and 4.1.3 are met.				
Combination packagings			Maximum net mass	
Inner packagings		Outer packagings	Packing group II	Packing group III
Glass	10 kg	<b>Drums</b>		
Plastics <sup>1</sup>	30 kg	steel (1A1, 1A2)	400 kg	400 kg
Metal	40 kg	aluminium (1B1, 1B2)	400 kg	400 kg
Paper <sup>1, 2</sup>	10 kg	other metal (1N1, 1N2)	400 kg	400 kg
Fibre <sup>1, 2</sup>	10 kg	plastics (1H1, 1H2)	400 kg	400 kg
		plywood (1D)	400 kg	400 kg
		fibre (1G) <sup>1</sup>	400 kg	400 kg
		<b>Boxes</b>		
		steel (4A)	400 kg	400 kg
		aluminium (4B)	400 kg	400 kg
		other metal (4N)	400 kg	400 kg
		natural wood (4C1)	400 kg	400 kg
		natural wood with sift-proof walls (4C2)	400 kg	400 kg
		plywood (4D)	400 kg	400 kg
		reconstituted wood (4F)	400 kg	400 kg
		fibreboard (4G) <sup>1</sup>	400 kg	400 kg
		expanded plastics (4H1)	60 kg	60 kg
		solid plastics (4H2)	400 kg	400 kg
		<b>Jerricans</b>		
		steel (3A1, 3A2)	120 kg	120 kg
		aluminium (3B1, 3B2)	120 kg	120 kg
		plastics (3H1, 3H2)	120 kg	120 kg
<sup>1</sup> Packagings shall be sift-proof.				
<sup>2</sup> These inner packagings shall not be used when the substances being transported may become liquid during transport.				
Single packagings				
<b>Drums</b>				
steel (1A1 or 1A2)			400 kg	400 kg
aluminium (1B1 or 1B2)			400 kg	400 kg
metal other than steel or aluminium (1N1 or 1N2)			400 kg	400 kg
plastics (1H1 or 1H2)			400 kg	400 kg
<b>Jerricans</b>				
steel (3A1 or 3A2)			120 kg	120 kg
aluminium (3B1 or 3B2)			120 kg	120 kg
plastics (3H1 or 3H2)			120 kg	120 kg
<b>Boxes</b>				
steel (4A) <sup>3</sup>			400 kg	400 kg
aluminium (4B) <sup>3</sup>			400 kg	400 kg
other metal (4N) <sup>3</sup>			400 kg	400 kg
natural wood (4C1) <sup>3</sup>			400 kg	400 kg
natural wood with sift-proof walls (4C2) <sup>3</sup>			400 kg	400 kg
plywood (4D) <sup>3</sup>			400 kg	400 kg
reconstituted wood (4F) <sup>3</sup>			400 kg	400 kg
fibreboard (4G) <sup>3</sup>			400 kg	400 kg
solid plastics (4H2) <sup>3</sup>			400 kg	400 kg
<b>Bags</b>				
Bags (5H3, 5H4, 5L3, 5M2) <sup>3, 4</sup>			50 kg	50 kg
<b>Composite packagings</b>				
Plastics receptacle in steel, aluminium, plywood, fibre or plastics drum (6HA1, 6HB1, 6HG1, 6HD1 or 6HH1)			400 kg	400 kg
Plastics receptacle in steel or aluminium crate or box, wooden box, plywood box, fibreboard box or solid plastics box (6HA2, 6HB2, 6HC, 6HD2, 6HG2 or 6HH2)			75 kg	75 kg
Glass receptacle in steel, aluminium, plywood or fibre drum (6PA1, 6PB1, 6PD1 or 6PG1) or in steel, aluminium, wooden, wickerwork hamper or fibreboard box (6PA2, 6PB2, 6PC, 6PD2 or 6PG2) or in solid or expanded plastics packaging (6PH1 or 6PH2)			75 kg	75 kg
<sup>3</sup> These packagings shall not be used when the substances being transported may become liquid during transport.				
<sup>4</sup> These packagings shall only be used for packing group II substances when transported in a closed cargo transport unit.				
<b>Pressure receptacles</b> , provided that the general provisions of 4.1.3.6 are met				

Part 4 – Packing and tank provisions

P410	PACKING INSTRUCTION <i>(continued)</i>	P410
<p><b>Special packing provisions:</b></p> <p><b>PP31</b> For UN Nos. 1326, 1339, 1340, 1341, 1343, 1352, 1358, 1373, 1374, 1378, 1379, 1382, 1384, 1385, 1390, 1393, 1394, 1400, 1401, 1405, 1417, 1431, 1437, 1871, 1923, 1929, 2004, 2008, 2318, 2545, 2546, 2624, 2805, 2813, 2830, 2835, 2844, 2881, 2940, 3078, 3088, 3170 (PG II), 3182, 3189, 3190, 3205, 3206, 3208 and 3209, packagings shall be hermetically sealed.</p> <p><b>PP39</b> For UN 1378, for metal packagings a venting device is required.</p> <p><b>PP40</b> For the following UN Nos., falling in PG II, bags are not allowed: 1326, 1340, 1352, 1358, 1374, 1378, 1382, 1390, 1393, 1394, 1396, 1400, 1401, 1402, 1405, 1409, 1417, 1418, 1436, 1437, 1871, 2624, 2805, 2813, 2830, 2835, 3078, 3131, 3132, 3134, 3170, 3182, 3208 and 3209.</p> <p><b>PP83</b> For UN 2813, waterproof bags containing not more than 20 g of substance for the purposes of heat formation may be packaged for transport. Each waterproof bag shall be sealed in a plastics bag and placed within an intermediate packaging. No outer packaging shall contain more than 400 g of substance. Water or liquid which may react with the water-reactive substance shall not be included in the packaging.</p>		
P411	PACKING INSTRUCTION	P411
<p>This instruction applies to UN 3270.</p> <p>The following packagings are authorized, provided that the general provisions of 4.1.1 and 4.1.3 are met:            Drums (1A2, 1B2, 1N2, 1H2, 1D, 1G);            Boxes (4A, 4B, 4N, 4C1, 4C2, 4D, 4F, 4G, 4H1, 4H2);            Jerricans (3A2, 3B2, 3H2).</p> <p>provided that explosion is not possible by reason of increased internal pressure.            The maximum net mass shall not exceed 30 kg.</p>		
P500	PACKING INSTRUCTION	P500
<p>This instruction applies to UN 3356.</p> <p>The following packagings are authorized, provided that the general provisions of 4.1.1 and 4.1.3 are met:            Drums (1A2, 1B2, 1N2, 1H2, 1D, 1G);            Boxes (4A, 4B, 4N, 4C1, 4C2, 4D, 4F, 4G, 4H1, 4H2);            Jerricans (3A2, 3B2, 3H2).</p> <p>Packagings shall conform to the packing group II performance level.            The generator(s) shall be transported in a package which meets the following requirements when one generator in the package is actuated:</p> <ol style="list-style-type: none"> <li>(a) Other generators in the package will not be actuated;</li> <li>(b) Packaging material will not ignite; and</li> <li>(c) The outside surface temperature of the completed package shall not exceed 100 °C.</li> </ol>		

Chapter 4.1 – Use of packagings, including IBCs and large packagings

P501		PACKING INSTRUCTION	P501
This instruction applies to UN 2015.			
The following packagings are authorized, provided that the general provisions of 4.1.1 and 4.1.3 are met:			
Combination packagings	Inner packagings maximum capacity	Outer packagings maximum net mass	
(1) Boxes (4A, 4B, 4N, 4C1, 4C2, 4D, 4H2) or drums (1A1, 1A2, 1B1, 1B2, 1N1, 1N2, 1H1, 1H2, 1D) or jerricans (3A1, 3A2, 3B1, 3B2, 3H1, 3H2) with glass, plastics or metal inner packagings	5 ℓ	125 kg	
(2) Fibreboard box (4G) or fibre drum (1G), with plastics or metal inner packagings each in a plastics bag	2 ℓ	50 kg	
Single packagings		Maximum capacity	
<b>Drums</b>			
steel (1A1)		250 ℓ	
aluminium (1B1)		250 ℓ	
metal other than steel or aluminium (1N1)		250 ℓ	
plastics (1H1)		250 ℓ	
<b>Jerricans</b>			
steel (3A1)		60 ℓ	
aluminium (3B1)		60 ℓ	
plastics (3H1)		60 ℓ	
<b>Composite packagings</b>			
Plastics receptacle in steel or aluminium drum (6HA1, 6HB1)		250 ℓ	
Plastics receptacle in fibre, plastics or plywood drum (6HG1, 6HH1, 6HD1)		250 ℓ	
Plastics receptacle in steel or aluminium crate or box or plastics receptacle in wood, plywood, fibreboard or solid plastics box (6HA2, 6HB2, 6HC, 6HD2, 6HG2 or 6HH2)		60 ℓ	
Glass receptacle in steel, aluminium, fibre, plywood, solid plastics or expanded plastics drum (6PA1, 6PB1, 6PG1, 6PD1, 6PH1 or 6PH2) or in a steel, aluminium, wood, fibreboard or plywood box (6PA2, 6PB2, 6PC, 6PG2 or 6PD2)		60 ℓ	
<b>Additional provisions:</b>			
1 Packagings shall have a minimum ullage of 10%.			
2 Packagings shall be vented.			

## Part 4 – Packing and tank provisions

P502		PACKING INSTRUCTION		P502
The following packagings are authorized, provided that the general provisions of 4.1.1 and 4.1.3 are met:				
Combination packagings			Maximum net mass	
Inner packagings	Outer packagings			
Glass	5 ℓ	<b>Drums</b> steel (1A1, 1A2) aluminium (1B1, 1B2) other metal (1N1, 1N2) plywood (1D) fibre (1G) plastics (1H1, 1H2)	125 kg	
Metal	5 ℓ		125 kg	
Plastic	5 ℓ		125 kg	
			125 kg	
			125 kg	
			125 kg	
<b>Boxes</b>				
		steel (4A)	125 kg	
		aluminium (4B)	125 kg	
		other metal (4N)	125 kg	
		natural wood (4C1)	125 kg	
		natural wood with sift-proof walls (4C2)	125 kg	
		plywood (4D)	125 kg	
		reconstituted wood (4F)	125 kg	
		fibreboard (4G)	125 kg	
		expanded plastics (4H1)	60 kg	
		solid plastics (4H2)	125 kg	
Single packagings			Maximum capacity	
<b>Drums</b>				
steel (1A1)			250 ℓ	
aluminium (1B1)			250 ℓ	
plastics (1H1)			250 ℓ	
<b>Jerricans</b>				
steel (3A1)			60 ℓ	
aluminium (3B1)			60 ℓ	
plastics (3H1)			60 ℓ	
<b>Composite packagings</b>				
Plastics receptacle in steel or aluminium drum (6HA1, 6HB1)			250 ℓ	
Plastics receptacle in fibre, plastics or plywood drum (6HG1, 6HH1, 6HD1)			250 ℓ	
Plastics receptacle in steel or aluminium crate or box or plastics receptacle in wood, plywood, fibreboard or solid plastics box (6HA2, 6HB2, 6HC, 6HD2, 6HG2 or 6HH2)			60 ℓ	
Glass receptacle in steel, aluminium, fibre, plywood, solid plastics or expanded plastics drum (6PA1, 6PB1, 6PG1, 6PD1, 6PH1 or 6PH2) or in a steel, aluminium, wood, fibreboard or plywood box (6PA2, 6PB2, 6PC, 6PG2 or 6PD2)			60 ℓ	
<b>Special packing provision:</b>				
PP28 For UN 1873, only glass inner packagings or receptacles are authorized for combination and composite packagings.				



Chapter 4.1 – Use of packagings, including IBCs and large packagings

P503		PACKING INSTRUCTION		P503
The following packagings are authorized, provided that the general provisions of 4.1.1 and 4.1.3 are met:				
Combination packagings			Maximum net mass	
Inner packagings		Outer packagings		
Glass	5 kg	<b>Drums</b>		
Metal	5 kg	steel (1A1, 1A2)		125 kg
Plastic	5 kg	aluminium (1B1, 1B2)		125 kg
		other metal (1N1, 1N2)		125 kg
		fibre (1G)		125 kg
		plywood (1D)		125 kg
		plastics (1H1, 1H2)		125 kg
		<b>Boxes</b>		
		steel (4A)		125 kg
		aluminium (4B)		125 kg
		other metal (4N)		125 kg
		natural wood (4C1)		125 kg
		natural wood with sift-proof walls (4C2)		125 kg
		plywood (4D)		125 kg
		reconstituted wood (4F)		125 kg
		fibreboard (4G)		40 kg
		expanded plastics (4H1)		60 kg
		solid plastics (4H2)		125 kg
Single packagings			Maximum net mass	
Metal drums (1A1, 1A2, 1B1, 1B2, 1N1 or 1N2) with a maximum net mass.			250 kg	
Fibreboard (1G) or plywood drums (1D) fitted with inner liners.			200 kg	

P504		PACKING INSTRUCTION		P504
The following packagings are authorized, provided that the general provisions of 4.1.1 and 4.1.3 are met:				
Combination packagings			Maximum net mass	
(1)	Outer packagings: (1A1, 1A2, 1B1, 1B2, 1N1, 1N2, 1H1, 1H2, 1D, 1G, 4A, 4B, 4N, 4C1, 4C2, 4D, 4F, 4G, 4H2) Inner packagings: Glass receptacles with a maximum capacity of 5 ℓ		75 kg	
(2)	Outer packagings: 1A1, 1A2, 1B1, 1B2, 1N1, 1N2, 1H1, 1H2, 1D, 1G, 4A, 4B, 4N, 4C1, 4C2, 4D, 4F, 4G, 4H2 Inner packagings: Plastics receptacles with a maximum capacity of 30 ℓ		75 kg	
(3)	Outer packagings: 1G, 4F or 4G Inner packagings: Metal receptacles with a maximum capacity of 40 ℓ		125 kg	
(4)	Outer packagings: (1A1, 1A2, 1B2, 1N1, 1N2, 1H1, 1H2, 1D, 4A, 4B, 4N, 4C1, 4C2, 4D, 4H2) Inner packagings: Metal receptacles with a maximum capacity of 40 ℓ		225 kg	
Single packagings			Maximum capacity	
<b>Drums</b>				
	steel, non-removable head (1A1)		250 ℓ	
	aluminium, non-removable head (1B1)		250 ℓ	
	metal, other than steel or aluminium, non-removable head (1N1)		250 ℓ	
	plastics, non-removable head (1H1)		250 ℓ	
<b>Jerricans</b>				
	steel, non-removable head (3A1)		60 ℓ	
	aluminium, non-removable head (3B1)		60 ℓ	
	plastics, non-removable head (3H1)		60 ℓ	
<b>Composite packagings</b>				
	Plastics receptacle in steel or aluminium drum (6HA1, 6HB1)		250 ℓ	
	Plastics receptacle in fibre, plastics or plywood drum (6HG1, 6HH1, 6HD1)		120 ℓ	
	Plastics receptacle in steel or aluminium crate or box or plastics receptacle in wood, plywood, fibreboard or solid plastics box (6HA2, 6HB2, 6HC, 6HD2, 6HG2 or 6HH2)		60 ℓ	
	Glass receptacle in steel, aluminium, fibre, plywood, solid plastics or expanded plastics drum (6PA1, 6PB1, 6PG1, 6PD1, 6PH1 or 6PH2) or in steel, aluminium, wood, fibreboard or plywood box (6PA2, 6PB2, 6PC, 6PG2 or 6PD2)		60 ℓ	
<b>Special packing provisions:</b>				
PP10 For UN 2014 and UN 3149, the packaging shall be vented.				
PP31 For UN 2626, packagings shall be hermetically sealed.				

Part 4 – Packing and tank provisions

P520	PACKING INSTRUCTION								P520
This instruction applies to organic peroxides of class 5.2 and self-reactive substances of class 4.1.									
<p>The packagings listed below are authorized provided the general provisions of 4.1.1 and 4.1.3 and special provisions of 4.1.7 are met.</p> <p>The packing methods are designated OP1 to OP8. The packing methods appropriate for the individual currently assigned organic peroxides and self-reactive substances are listed in 2.4.2.3.2.3 and 2.5.3.2.4. The quantities specified for each packing method are the maximum quantities authorized per package. The following packagings are authorized:</p> <ol style="list-style-type: none"> <li>(1) Combination packagings with outer packagings comprising boxes (4A, 4B, 4N, 4C1, 4C2, 4D, 4F, 4G, 4H1 and 4H2), drums (1A1, 1A2, 1B1, 1B2, 1G, 1H1, 1H2 and 1D), jerricans (3A1, 3A2, 3B1, 3B2, 3H1 and 3H2);</li> <li>(2) Single packagings consisting of drums (1A1, 1A2, 1B1, 1B2, 1G, 1H1, 1H2 and 1D) and jerricans (3A1, 3A2, 3B1, 3B2, 3H1 and 3H2);</li> <li>(3) Composite packagings with plastics inner receptacles (6HA1, 6HA2, 6HB1, 6HB2, 6HC, 6HD1, 6HD2, 6HG1, 6HG2, 6HH1 and 6HH2).</li> </ol>									
<b>Maximum quantity per packaging/package<sup>1</sup> for packing methods OP1 to OP8</b>									
<b>Packing method</b>	<b>OP1</b>	<b>OP2<sup>1</sup></b>	<b>OP3</b>	<b>OP4<sup>1</sup></b>	<b>OP5</b>	<b>OP6</b>	<b>OP7</b>	<b>OP8</b>	
<b>Maximum quantity</b>									
Maximum mass (kg) for solids and for combination packagings (liquid and solid)	0.5	0.5/10	5	5/25	25	50	50	400 <sup>2</sup>	
Maximum contents in litres for liquids <sup>3</sup>	0.5	–	5	–	30	60	60	225 <sup>4</sup>	
<p><sup>1</sup> If two values are given, the first applies to the maximum net mass per inner packaging and the second to the maximum net mass of the complete package.</p> <p><sup>2</sup> 60 kg for jerricans/200 kg for boxes and, for solids, 400 kg in combination packagings with outer packagings comprising boxes (4C1, 4C2, 4D, 4F, 4G, 4H1 and 4H2) and with inner packagings of plastics or fibre with a maximum net mass of 25 kg.</p> <p><sup>3</sup> Viscous liquids shall be treated as solids when they do not meet the criteria provided in the definition for liquids presented in 1.2.1.</p> <p><sup>4</sup> 60 ℓ for jerricans.</p>									
<b>Additional provisions:</b>									
<ol style="list-style-type: none"> <li>1 Metal packagings, including inner packagings of combination packagings and outer packagings of combination or composite packagings, may only be used for packing methods OP7 and OP8.</li> <li>2 In combination packagings, glass receptacles may only be used as inner packagings with a maximum content of 0.5 kg for solids or 0.5 ℓ for liquids.</li> <li>3 In combination packagings, cushioning materials shall not be readily combustible.</li> <li>4 The packaging of an organic peroxide or self-reactive substance required to bear an EXPLOSIVE subsidiary risk label (Model No. 1, see 5.2.2.2.2) shall also comply with the provisions given in 4.1.5.10 and 4.1.5.11.</li> </ol>									
<b>Special packing provisions:</b>									
<p><b>PP21</b> For certain self-reactive substances of types B or C, UN Nos. 3221, 3222, 3223, 3224, 3231, 3232, 3233 and 3234, a smaller packaging than that allowed by packing methods OP5 or OP6 respectively shall be used (see 4.1.7 and 2.4.2.3.2.3).</p> <p><b>PP22</b> UN 3241, 2-bromo-2-nitropropane-1,3-diol, shall be packed in accordance with packing method OP6.</p>									
P600	PACKING INSTRUCTION								P600
This instruction applies to UN Nos. 1700, 2016 and 2017.									
<p>The following packagings are authorized, provided the general provisions of 4.1.1 and 4.1.3 are met:</p> <p>Outer packagings: (1A1, 1A2, 1B1, 1B2, 1N1, 1N2, 1H1, 1H2, 1D, 1G, 4A, 4B, 4N, 4C1, 4C2, 4D, 4F, 4G, 4H2) meeting the packing group II performance level. The articles shall be individually packaged and separated from each other using partitions, dividers, inner packagings or cushioning material to prevent inadvertent discharge during normal conditions of transport.</p> <p>Maximum net mass: 75 kg</p>									

P601	PACKING INSTRUCTION	P601
<p>The following packagings are authorized provided the general provisions of 4.1.1 and 4.1.3 are met and the packagings are hermetically sealed:</p> <p>(1) Combination packagings with a maximum gross mass of 15 kg, consisting of:</p> <ul style="list-style-type: none"> <li>– one or more glass inner packaging(s) with a maximum net quantity of 1 litre each and filled to not more than 90% of their capacity; the closure(s) of which shall be physically held in place by any means capable of preventing back-off or loosening by impact or vibration during transport, individually placed in</li> <li>– metal receptacles together with cushioning and absorbent material sufficient to absorb the entire contents of the glass inner packaging(s), further packed in</li> <li>– 1A1, 1A2, 1B1, 1B2, 1N1, 1N2, 1H1, 1H2, 1D, 1G, 4A, 4B, 4N, 4C1, 4C2, 4D, 4F, 4G or 4H2 outer packagings.</li> </ul> <p>(2) Combination packagings consisting of metal inner packagings not exceeding 5 l in capacity individually packed with absorbent material sufficient to absorb the contents and inert cushioning material in 1A1, 1A2, 1B1, 1B2, 1N1, 1N2, 1H1, 1H2, 1D, 1G, 4A, 4B, 4N, 4C1, 4C2, 4D, 4F, 4G or 4H2 outer packagings with a maximum gross mass of 75 kg. Inner packagings shall not be filled to more than 90% of their capacity. The closure of each inner packaging shall be physically held in place by any means capable of preventing back-off or loosening of the closure by impact or vibration during transport.</p> <p>(3) Packagings consisting of:</p> <p>Outer packagings: Steel or plastics drums, (1A1, 1A2, 1H1 or 1H2), tested in accordance with the test provisions in 6.1.5 at a mass corresponding to the mass of the assembled package either as a packaging intended to contain inner packagings, or as a single packaging intended to contain solids or liquids, and marked accordingly.</p> <p>Inner packagings: Drums and composite packagings (1A1, 1B1, 1N1, 1H1 or 6HA1), meeting the provisions of chapter 6.1 for single packagings, subject to the following conditions:</p> <ol style="list-style-type: none"> <li>.1 the hydraulic pressure test shall be conducted at a pressure of at least 3 bar (gauge pressure);</li> <li>.2 the design and production leakproofness tests shall be conducted at a test pressure of 0.30 bar;</li> <li>.3 they shall be isolated from the outer drum by the use of inert shock-mitigating cushioning material which surrounds the inner packaging on all sides;</li> <li>.4 their capacity shall not exceed 125 l;</li> <li>.5 closures shall be of a screw-cap type that are:             <ol style="list-style-type: none"> <li>(i) physically held in place by any means capable of preventing back-off or loosening of the closure by impact or vibration during transport; and</li> <li>(ii) provided with a cap seal.</li> </ol> </li> <li>.6 The outer and inner packagings shall be subjected periodically to a leakproofness test according to .2 at intervals of not more than two and a half years; and</li> <li>.7 The outer and inner packagings shall bear in clearly legible and durable characters:             <ol style="list-style-type: none"> <li>(i) the date (month, year) of the initial testing and the latest periodic test;</li> <li>(ii) the name or authorized symbol of the party performing the tests and inspections.</li> </ol> </li> </ol> <p>(4) Pressure receptacles, provided that the general provisions of 4.1.3.6 are met. They shall be subjected to an initial test and periodic tests every 10 years at a pressure of not less than 1 MPa (10 bar) (gauge pressure). Pressure receptacles may not be equipped with any pressure relief device. Each pressure receptacle containing a toxic by inhalation liquid with an LC<sub>50</sub> less than or equal to 200 ml/m<sup>3</sup> (ppm) shall be closed with a plug or valve conforming to the following:</p> <ol style="list-style-type: none"> <li>(a) Each plug or valve shall have a taper-threaded connection directly to the pressure receptacle and be capable of withstanding the test pressure of the pressure receptacle without damage or leakage;</li> <li>(b) Each valve shall be of the packless type with non-perforated diaphragm, except that, for corrosive materials, a valve may be of the packed type with an assembly made gas-tight by means of a seal cap with gasket joint attached to the valve body or the pressure receptacle to prevent loss of material through or past the packing;</li> <li>(c) Each valve outlet shall be sealed by a threaded cap or threaded solid plug and inert gasket material;</li> <li>(d) The materials of construction for the pressure receptacle, valves, plugs, outlet caps, luting and gaskets shall be compatible with each other and with the lading.</li> </ol> <p>Each pressure receptacle with a wall thickness at any point of less than 2.0 mm and each pressure receptacle that does not have fitted valve protection shall be transported in an outer packaging. Pressure receptacles shall not be manifolded or interconnected.</p>		

Part 4 – Packing and tank provisions

P602	PACKING INSTRUCTION	P602
<p>The following packagings are authorized, provided the general provisions of 4.1.1 and 4.1.3 are met and the packagings are hermetically sealed:</p> <p>(1) Combination packagings with a maximum gross mass of 15 kg, consisting of:</p> <ul style="list-style-type: none"> <li>– one or more glass inner packaging(s) with a maximum net quantity of 1 litre each and filled to not more than 90% of their capacity, the closure(s) of which shall be physically held in place by any means capable of preventing back-off or loosening by impact or vibration during transport, individually placed in</li> <li>– metal receptacles together with cushioning and absorbent material sufficient to absorb the entire contents of the glass inner packaging(s), further packed in</li> <li>– 1A1, 1A2, 1B1, 1B2, 1N1, 1N2, 1H1, 1H2, 1D, 1G, 4A, 4B, 4N, 4C1, 4C2, 4D, 4F, 4G or 4H2 outer packagings.</li> </ul> <p>(2) Combination packagings consisting of metal inner packagings individually packed with absorbent material sufficient to absorb the contents and inert cushioning material in 1A1, 1A2, 1B1, 1B2, 1N1, 1N2, 1H1, 1H2, 1D, 1G, 4A, 4B, 4N, 4C1, 4C2, 4D, 4F, 4G or 4H2 outer packagings with a maximum gross mass of 75 kg. Inner packagings shall not be filled to more than 90% of their capacity. The closure of each inner packaging shall be physically held in place by any means capable of preventing back-off or loosening of the closure by impact or vibration during transport. Inner packagings shall not exceed 5 l in capacity.</p> <p>(3) Drums and composite packagings (1A1, 1B1, 1N1, 1H1, 6HA1 or 6HH1), subject to the following conditions:</p> <ol style="list-style-type: none"> <li>.1 the hydraulic pressure test shall be conducted at a pressure of at least 3 bar (gauge pressure);</li> <li>.2 the design and production leakproofness tests shall be conducted at a test pressure of 0.30 bar; and</li> <li>.3 closures shall be of a screw-cap type that are: <ul style="list-style-type: none"> <li>(i) physically held in place by any means capable of preventing back-off or loosening of the closure by impact or vibration during transport; and</li> <li>(ii) provided with a cap seal.</li> </ul> </li> </ol> <p>(4) Pressure receptacles, provided that the general provisions of 4.1.3.6 are met. They shall be subjected to an initial test and periodic tests every 10 years at a pressure of not less than 1 MPa (10 bar) (gauge pressure). Pressure receptacles may not be equipped with any pressure relief device. Each pressure receptacle containing a toxic by inhalation liquid with an LC<sub>50</sub> less than or equal to 200 ml/m<sup>3</sup> (ppm) shall be closed with a plug or valve conforming to the following:</p> <ol style="list-style-type: none"> <li>(a) Each plug or valve shall have a taper-threaded connection directly to the pressure receptacle and be capable of withstanding the test pressure of the pressure receptacle without damage or leakage;</li> <li>(b) Each valve shall be of the packless type with non-perforated diaphragm, except that, for corrosive materials, a valve may be of the packed type with an assembly made gas-tight by means of a seal cap with gasket joint attached to the valve body or the pressure receptacle to prevent loss of material through or past the packing;</li> <li>(c) Each valve outlet shall be sealed by a threaded cap or threaded solid plug and inert gasket material;</li> <li>(d) The materials of construction for the pressure receptacle, valves, plugs, outlet caps, luting and gaskets shall be compatible with each other and with the lading.</li> </ol> <p>Each pressure receptacle with a wall thickness at any point of less than 2.0 mm and each pressure receptacle that does not have fitted valve protection shall be transported in an outer packaging. Pressure receptacles shall not be manifolded or interconnected.</p>		

P620	PACKING INSTRUCTION	P620
This instruction applies to UN 2814 and UN 2900.		
<p>The following packagings are authorized, provided the special packing provisions of 4.1.8 are met:</p> <p>Packagings meeting the provisions of chapter 6.3 and approved accordingly consisting of:</p> <p>.1 Inner packagings comprising:</p> <ul style="list-style-type: none"> <li>(i) leakproof primary receptacle(s);</li> <li>(ii) a leakproof secondary packaging;</li> <li>(iii) other than for solid infectious substances, an absorbent material in sufficient quantity to absorb the entire contents placed between the primary receptacle(s) and the secondary packaging; if multiple primary receptacles are placed in a single secondary packaging, they shall be either individually wrapped or separated so as to prevent contact between them;</li> </ul> <p>.2 A rigid outer packaging:</p> <p>Drums (1A1, 1A2, 1B1, 1B2, 1N1, 1N2, 1H1, 1H2, 1D, 1G);</p> <p>Boxes (4A, 4B, 4N, 4C1, 4C2, 4D, 4F, 4G, 4H1, 4H2);</p> <p>Jerricans (3A1, 3A2, 3B1, 3B2, 3H1, 3H2).</p> <p>The smallest external dimension shall be not less than 100 mm.</p>		
<p><b>Additional provisions:</b></p> <ol style="list-style-type: none"> <li>1 Inner packagings containing infectious substances shall not be consolidated with inner packagings containing unrelated types of goods. Complete packages may be overpacked in accordance with the provisions of 1.2.1 and 5.1.2: such an overpack may contain dry ice.</li> <li>2 Other than for exceptional consignments, such as whole organs which require special packaging, the following additional provisions shall apply: <ul style="list-style-type: none"> <li>(a) <i>Substances consigned at ambient temperatures or at a higher temperature.</i> Primary receptacles shall be of glass, metal or plastics. Positive means of ensuring a leakproof seal shall be provided, e.g., a heat seal, a skirted stopper or a metal crimp seal. If screw caps are used, they shall be secured by positive means, e.g., tape, paraffin sealing tape or a manufactured locking closure;</li> <li>(b) <i>Substances consigned refrigerated or frozen.</i> Ice, dry ice or other refrigerant shall be placed around the secondary packaging(s) or alternatively in an overpack with one or more complete packages marked in accordance with 6.3.3. Interior supports shall be provided to secure secondary packaging(s) or packages in position after the ice or dry ice has dissipated. If ice is used, the outer packaging or overpack shall be leakproof. If dry ice is used, the outer packaging or overpack shall permit the release of carbon dioxide gas. The primary receptacle and the secondary packaging shall maintain their integrity at the temperature of the refrigerant used;</li> <li>(c) <i>Substances consigned in liquid nitrogen.</i> Plastics primary receptacles capable of withstanding very low temperature shall be used. The secondary packaging shall also be capable of withstanding very low temperatures, and in most cases will need to be fitted over the primary receptacle individually. Provisions for the consignment of liquid nitrogen shall also be fulfilled. The primary receptacle and the secondary packaging shall maintain their integrity at the temperature of the liquid nitrogen.</li> <li>(d) Lyophilized substances may also be transported in primary receptacles that are flame-sealed glass ampoules or rubber-stoppered glass vials fitted with metal seals.</li> </ul> </li> <li>3 Whatever the intended temperature of the consignment, the primary receptacle or the secondary packaging shall be capable of withstanding, without leakage, an internal pressure producing a pressure differential of not less than 95 kPa and temperatures in the range -40°C to +55°C.</li> <li>4 Other dangerous goods shall not be packed in the same packaging as class 6.2 infectious substances unless they are necessary for maintaining the viability, stabilizing or preventing degradation or neutralizing the hazards of the infectious substances. A quantity of 30 ml or less of dangerous goods included in classes 3, 8 or 9 may be packed in each primary receptacle containing infectious substances. These small quantities of dangerous goods of classes 3, 8 or 9 are not subject to any additional provisions of this Code when packed in accordance with this packing instruction.</li> <li>5 Alternative packagings for the transport of animal material may be authorized by the competent authority in accordance with the provisions of 4.1.3.7.</li> </ol>		

Part 4 – Packing and tank provisions

P621	PACKING INSTRUCTION	P621
This instruction applies to UN 3291.		
<p>The following packagings are authorized provided that the general provisions of 4.1.1 except 4.1.1.15 and 4.1.3 are met:</p> <p>(1) Provided that there is sufficient absorbent material to absorb the entire amount of liquid present and the packaging is capable of retaining liquids:            Drums (1A2, 1B2, 1N2, 1H2, 1D, 1G);            Boxes (4A, 4B, 4N, 4C1, 4C2, 4D, 4F, 4G, 4H1, 4H2);            Jerricans (3A2, 3B2, 3H2).</p> <p>Packagings shall conform to the packing group II performance level for solids.</p> <p>(2) For packages containing larger quantities of liquid:            Drums (1A1, 1A2, 1B1, 1B2, 1N1, 1N2, 1H1, 1H2, 1D, 1G);            Jerricans (3A1, 3A2, 3B1, 3B2, 3H1, 3H2);</p> <p>Composite packagings (6HA1, 6HB1, 6HG1, 6HH1, 6HD1, 6HA2, 6HB2, 6HC, 6HD2, 6HG2, 6HH2, 6PA1, 6PB1, 6PG1, 6PD1, 6PH1, 6PH2, 6PA2, 6PB2, 6PC, 6PG2 or 6PD2).</p> <p>Packagings shall conform to the packing group II performance level for liquids.</p>		
<p><b>Additional requirement:</b>            Packagings intended to contain sharp objects such as broken glass and needles shall be resistant to puncture and retain liquids under the performance test conditions in Chapter 6.1.</p>		

P650	PACKING INSTRUCTION	P650
This instruction applies to UN 3373.		
<p>(1) The packaging shall be of good quality, strong enough to withstand the shocks and loadings normally encountered during transport, including transshipment between cargo transport units and between cargo transport units and warehouses as well as any removal from a pallet or overpack for subsequent manual or mechanical handling. Packagings shall be constructed and closed to prevent any loss of contents that might be caused under normal conditions of transport by vibration or by changes in temperature, humidity or pressure.</p> <p>(2) The packaging shall consist of at least three components:</p> <ul style="list-style-type: none"> <li>(a) a primary receptacle;</li> <li>(b) a secondary packaging; and</li> <li>(c) an outer packaging.</li> </ul> <p>of which either the secondary or the outer packaging shall be rigid.</p> <p>(3) Primary receptacles shall be packed in secondary packagings in such a way that, under normal conditions of transport, they cannot break, be punctured or leak their contents into the secondary packaging. Secondary packagings shall be secured in outer packagings with suitable cushioning material. Any leakage of the contents shall not compromise the integrity of the cushioning material or of the outer packaging.</p> <p>(4) For transport, the mark illustrated below shall be displayed on the external surface of the outer packaging on a background of a contrasting colour and shall be clearly visible and legible. The mark shall be in the form of a square set at an angle of 45° (diamond-shaped) with each side having a length of at least 50 mm, the width of the line shall be at least 2 mm and the letters and numbers shall be at least 6 mm high. The proper shipping name "BIOLOGICAL SUBSTANCE, CATEGORY B" in letters at least 6 mm high shall be marked on the outer packaging adjacent to the diamond-shaped mark.</p>		
		
<p>(5) At least one surface of the outer packaging shall have a minimum dimension of 100 mm × 100 mm.</p> <p>(6) The completed package shall be capable of successfully passing the drop test in 6.3.5.3 as specified in 6.3.5.2 of this Code at a height of 1.2 m. Following the appropriate drop sequence, there shall be no leakage from the primary receptacle(s) which shall remain protected by absorbent material, when required, in the secondary packaging.</p> <p>(7) For liquid substances</p> <ul style="list-style-type: none"> <li>(a) The primary receptacle(s) shall be leakproof;</li> <li>(b) The secondary packaging shall be leakproof;</li> <li>(c) If multiple fragile primary receptacles are placed in a single secondary packaging, they shall either be individually wrapped or separated to prevent contact between them;</li> <li>(d) Absorbent material shall be placed between the primary receptacle(s) and the secondary packaging. The absorbent material shall be in a quantity sufficient to absorb the entire contents of the primary receptacle(s) so that any release of the liquid substance will not compromise the integrity of the cushioning material or of the outer packaging;</li> <li>(e) The primary receptacle or the secondary packaging shall be capable of withstanding, without leakage, an internal pressure of 95 kPa (0.95 bar).</li> </ul> <p>(8) For solid substances</p> <ul style="list-style-type: none"> <li>(a) The primary receptacle(s) shall be siftproof;</li> <li>(b) The secondary packaging shall be siftproof;</li> <li>(c) If multiple fragile primary receptacles are placed in a single secondary packaging, they shall either be individually wrapped or separated to prevent contact between them.</li> <li>(d) If there is any doubt as to whether or not residual liquid may be present in the primary receptacle during transport then a packaging suitable for liquids, including absorbent materials, shall be used.</li> </ul>		

## Part 4 – Packing and tank provisions

P650	PACKING INSTRUCTION (continued)	P650
<p>(9) Refrigerated or frozen specimens: Ice, dry ice and liquid nitrogen</p> <p>(a) When dry ice or liquid nitrogen is used as a coolant, the requirements of 5.5.3 shall apply. When used, ice shall be placed outside the secondary packagings or in the outer packaging or an overpack. Interior supports shall be provided to secure the secondary packagings in the original position. If ice is used, the outside packaging or overpack shall be leakproof.</p> <p>(b) The primary receptacle and the secondary packaging shall maintain their integrity at the temperature of the refrigerant used as well as the temperatures and the pressures which could result if refrigeration were lost.</p> <p>(10) When packages are placed in an overpack, the package markings required by this packing instruction shall either be clearly visible or be reproduced on the outside of the overpack.</p> <p>(11) Infectious substances assigned to UN 3373 which are packed and marked in accordance with this packing instruction are not subject to any other provisions of this Code.</p> <p>(12) Clear instructions on filling and closing such packages shall be provided by packaging manufacturers and subsequent distributors to the consignor or to the person who prepares the package (e.g., patient) to enable the package to be correctly prepared for transport.</p> <p>(13) Other dangerous goods shall not be packed in the same packaging as class 6.2 infectious substances unless they are necessary for maintaining the viability, stabilizing or preventing degradation or neutralizing the hazards of the infectious substances. A quantity of 30 ml or less of dangerous goods included in classes 3, 8 or 9 may be packed in each primary receptacle containing infectious substances. When these small quantities of dangerous goods are packed with infectious substances in accordance with this packing instruction, no other provisions of the Code need be met.</p>		
<p><b>Additional provision:</b> Alternative packagings for the transport of animal material may be authorized by the competent authority in accordance with the provisions of 4.1.3.7.</p>		
P800	PACKING INSTRUCTION	P800
This instruction applies to UN 2803 and UN 2809.		
The following packagings are authorized, provided the general provisions of 4.1.1 and 4.1.3 are met:		
<p>(1) Pressure receptacles, provided that the general provisions of 4.1.3.6 are met.</p> <p>(2) Steel flasks or bottles with threaded closures with a capacity not exceeding 3.0 l; or</p> <p>(3) Combination packagings which conform to the following provisions:</p> <p>(a) Inner packagings shall comprise glass, metal or rigid plastics intended to contain liquids with a maximum net mass of 15 kg each.</p> <p>(b) The inner packagings shall be packed with sufficient cushioning material to prevent breakage.</p> <p>(c) Either the inner packagings or the outer packagings shall have inner liners or bags of strong leakproof and puncture-resistant material impervious to the contents and completely surrounding the contents to prevent it from escaping from the package irrespective of its position or orientation.</p> <p>(d) The following outer packagings and maximum net masses are authorized:</p>		
	<b>Outer packaging</b>	<b>Maximum net mass</b>
<b>Drums</b>		
steel ((1A1, 1A2)		400 kg
metal, other than steel or aluminium (1N1, 1N2)		400 kg
plastics (1H1, 1H2)		400 kg
plywood (1D)		400 kg
fibre (1G)		400 kg
<b>Boxes</b>		
steel (4A)		400 kg
metal, other than steel or aluminium (4N)		400 kg
natural wood (4C1)		250 kg
natural wood with sift-proof walls (4C2)		250 kg
plywood (4D)		250 kg
reconstituted wood (4F)		125 kg
fibreboard (4G)		125 kg
expanded plastics (4H1)		60 kg
solid plastics (4H2)		125 kg
<p><b>Special packing provision:</b> PP41 For UN 2803, when it is necessary to transport gallium at low temperatures in order to maintain it in a completely solid state, the above packagings may be overpacked in a strong, water-resistant outer packaging which contains dry ice or other means of refrigeration. If a refrigerant is used, all of the above materials used in the packaging of gallium shall be chemically and physically resistant to the refrigerant and shall have impact resistance at the low temperatures of the refrigerant employed. If dry ice is used, the outer packaging shall permit the release of carbon dioxide gas.</p>		



P801	PACKING INSTRUCTION	P801
This instruction applies to new and used batteries assigned to UN Nos. 2794, 2795 or 3028.		
<p>The following packagings are authorized, provided the general provisions of 4.1.1, except 4.1.1.3, and 4.1.3 are met, except that packagings need not conform to the provisions of part 6:</p> <ol style="list-style-type: none"> <li>(1) Rigid outer packagings;</li> <li>(2) Wooden slatted crates;</li> <li>(3) Pallets.</li> </ol> <p>Used storage batteries may also be transported loose in stainless steel or plastics battery boxes capable of containing any free liquid.</p>		
<p><b>Additional provisions:</b></p> <ol style="list-style-type: none"> <li>1 Batteries shall be protected against short circuits.</li> <li>2 Batteries stacked shall be adequately secured in tiers separated by a layer of non-conductive material.</li> <li>3 Battery terminals shall not support the mass of other superimposed elements.</li> <li>4 Batteries shall be packaged or secured to prevent inadvertent movement.</li> <li>5 For UN 2794 and UN 2795, batteries shall be capable of passing a tilt test at an angle of 45° with no spillage of liquid.</li> </ol>		

P802	PACKING INSTRUCTION	P802
The following packagings are authorized, provided the general provisions of 4.1.1 and 4.1.3 are met:		
<ol style="list-style-type: none"> <li>(1) Combination packagings            Outer packagings: 1A1, 1A2, 1B1, 1B2, 1N1, 1N2, 1H1, 1H2, 1D, 1G, 4A, 4B, 4N, 4C1, 4C2, 4D, 4F, 4G or 4H2;            maximum net mass: 75 kg.            Inner packagings: glass or plastics; maximum capacity: 10 ℓ.</li> <li>(2) Combination packagings            Outer packagings: 1A1, 1A2, 1B1, 1B2, 1N1, 1N2, 1H1, 1H2, 1D, 1G, 4A, 4B, 4N, 4C1, 4C2, 4D, 4F, 4G or 4H2;            maximum net mass: 125 kg.            Inner packagings: metal; maximum capacity: 40 ℓ</li> <li>(3) Composite packagings: Glass receptacle in steel, aluminium, plywood or solid plastics drum (6PA1, 6PB1, 6PD1 or 6PH2) or in a steel, aluminium, wood or plywood box (6PA2, 6PB2, 6PC or 6PD2); maximum capacity: 60 ℓ.</li> <li>(4) Steel drums (1A1) with a maximum capacity of 250 ℓ.</li> <li>(5) Pressure receptacles may be used provided that the general provisions of 4.1.3.6 are met.</li> </ol>		
<p><b>Special packing provisions:</b></p> <p><b>PP79</b> For UN 1790 with more than 60% but not more than 85% hydrofluoric acid, see P001.</p> <p><b>PP81</b> For UN 1790 with not more than 85% hydrogen fluoride and UN 2031 with more than 55% nitric acid, the permitted use of plastics drums and jerricans as single packagings shall be two years from their date of manufacture.</p>		

P803	PACKING INSTRUCTION	P803
This instruction applies to UN 2028.		
<p>The following packagings are authorized, provided the general provisions of 4.1.1 and 4.1.3 are met:</p> <ol style="list-style-type: none"> <li>(1) Drums (1A2, 1B2, 1N2, 1H2, 1D, 1G);</li> <li>(2) Boxes (4A, 4B, 4N, 4C1, 4C2, 4D, 4F, 4G, 4H2);</li> </ol> <p>Maximum net mass: 75 kg.</p> <p>The articles shall be individually packaged and separated from each other, using partitions, dividers, inner packagings or cushioning material to prevent inadvertent discharge during normal conditions of transport.</p>		

## Part 4 – Packing and tank provisions

P804	PACKING INSTRUCTION	P804
This instruction applies to UN 1744.		
The following packagings are authorized provided the general provisions of 4.1.1 and 4.1.3 are met and the packagings are hermetically sealed:		
<p>(1) Combination packagings with a maximum gross mass of 25 kg, consisting of one or more glass inner packaging(s) with a maximum capacity of 1.3 litres each and filled to no more than 90% of their capacity; the closure(s) of which shall be physically held in place by any means capable of preventing back-off or loosening by impact or vibration during transport, individually placed in:</p> <ul style="list-style-type: none"> <li>– metal or rigid plastics receptacles together with cushioning and absorbent material sufficient to absorb the entire contents of the glass inner packaging(s), further packed in:</li> <li>– 1A1, 1A2, 1B1, 1B2, 1N1, 1N2, 1H1, 1H2, 1D, 1G, 4A, 4B, 4N, 4C1, 4C2, 4D, 4F, 4G or 4H2 outer packagings.</li> </ul> <p>(2) Combination packagings consisting of metal or polyvinylidene fluoride (PVDF) inner packagings, not exceeding 5 litres in capacity individually packed with absorbent material sufficient to absorb the contents and inert cushioning material in 1A1, 1A2, 1B1, 1B2, 1N1, 1N2, 1H1, 1H2, 1D, 1G, 4A, 4B, 4N, 4C1, 4C2, 4D, 4F, 4G or 4H2 outer packagings with a maximum gross mass of 75 kg. Inner packagings shall not be filled to more than 90% of their capacity. The closure of each inner packaging shall be physically held in place by any means capable of preventing back-off or loosening of the closure by impact or vibration during transport.</p> <p>(3) Packagings consisting of:</p> <p>Outer packagings:</p> <p>Steel or plastics drums (1A1, 1A2, 1H1 or 1H2) tested in accordance with the test requirements in 6.1.5 at a mass corresponding to the mass of the assembled package either as a packaging intended to contain inner packagings, or as a single packaging intended to contain solids or liquids, and marked accordingly;</p> <p>Inner packagings:</p> <p>Drums and composite packagings (1A1, 1B1, 1N1, 1H1 or 6HA1) meeting the requirements of chapter 6.1 for single packagings, subject to the following conditions:</p> <ul style="list-style-type: none"> <li>(a) The hydraulic pressure test shall be conducted at a pressure of at least 300 kPa (3 bar) (gauge pressure);</li> <li>(b) The design and production leakproofness tests shall be conducted at a test pressure of 30 kPa (0.3 bar);</li> <li>(c) They shall be isolated from the outer drum by the use of inert shock-mitigating cushioning material which surrounds the inner packaging on all sides;</li> <li>(d) Their capacity shall not exceed 125 litres;</li> <li>(e) Closures shall be of a screw type that are: <ul style="list-style-type: none"> <li>(i) Physically held in place by any means capable of preventing back-off or loosening of the closure by impact or vibration during transport;</li> <li>(ii) Provided with a cap seal;</li> </ul> </li> <li>(f) The outer and inner packagings shall be subjected periodically to an internal inspection and leakproofness test according to (b) at intervals of not more than two and a half years; and</li> <li>(g) The outer and inner packagings shall bear in clearly legible and durable characters: <ul style="list-style-type: none"> <li>(i) the date (month, year) of the initial test and the latest periodic test and inspection of the inner packaging; and</li> <li>(ii) the name or authorized symbol of the expert performing the tests and inspections.</li> </ul> </li> </ul> <p>(4) Pressure receptacles, provided that the general provisions of 4.1.3.6 are met.</p> <ul style="list-style-type: none"> <li>(a) They shall be subjected to an initial test and periodic tests every 10 years at a pressure of not less than 1 MPa (10 bar) (gauge pressure);</li> <li>(b) They shall be subjected periodically to an internal inspection and leakproofness test at intervals of not more than two and a half years;</li> <li>(c) They may not be equipped with any pressure relief device;</li> <li>(d) Each pressure receptacle shall be closed with a plug or valve(s) fitted with a secondary closure device; and</li> <li>(e) The materials of construction for the pressure receptacle, valves, plugs, outlet caps, luting and gaskets shall be compatible with each other and with the contents.</li> </ul>		

Chapter 4.1 – Use of packagings, including IBCs and large packagings

P900	PACKING INSTRUCTION	P900
This instruction applies to UN 2216.		
<p>The following packagings are authorized, provided the general provisions of 4.1.1 and 4.1.3 are met:</p> <p>(1) Packagings according to P002; or</p> <p>(2) Bags (5H1, 5H2, 5H3, 5H4, 5L1, 5L2, 5L3, 5M1 or 5M2) with a maximum net mass of 50 kg.</p> <p>Fish meal may also be transported unpackaged when it is packed in closed cargo transport units and the free air space has been restricted to a minimum.</p>		
P901	PACKING INSTRUCTION	P901
This instruction applies to UN 3316.		
<p>The following combination packagings are authorized provided the general provisions of 4.1.1 and 4.1.3 are met:</p> <p>Drums (1A1, 1A2, 1B1, 1B2, 1N1, 1N2, 1H1, 1H2, 1D, 1G);</p> <p>Boxes (4A, 4B, 4N, 4C1, 4C2, 4D, 4F, 4G, 4H1, 4H2);</p> <p>Jerricans (3A1, 3A2, 3B1, 3B2, 3H1, 3H2).</p> <p>Packagings shall conform to the performance level consistent with the packing group assigned to the kit as a whole (see 3.3.1, special provision 251).</p> <p>Maximum quantity of dangerous goods per outer packaging: 10 kg excluding the mass of any carbon dioxide, solid (dry ice) used as a refrigerant</p> <p><b>Additional requirement:</b></p> <p>Dangerous goods in kits shall be packed in inner packagings which shall not exceed either 250 ml or 250 g and shall be protected from other materials in the kit..</p>		
P902	PACKING INSTRUCTION	P902
This instruction applies to UN 3268.		
<p>Packaged articles:</p> <p>The following packagings are authorized provided the general provisions of 4.1.1 and 4.1.3 are met:</p> <p>Drums (1A2, 1B2, 1N2, 1H2, 1D, 1G);</p> <p>Boxes (4A, 4B, 4N, 4C1, 4C2, 4D, 4F, 4G, 4H1, 4H2);</p> <p>Jerricans (3A2, 3B2, 3H2).</p> <p>Packagings shall conform to the packing group III performance level.</p> <p>The packagings shall be designed and constructed so as to prevent movement of the articles and inadvertent operation during normal conditions of transport.</p> <p>Unpackaged articles:</p> <p>The articles may also be transported unpackaged in dedicated handling devices, vehicles or containers when moved from where they are manufactured to an assembly plant.</p> <p><b>Additional requirement:</b></p> <p>Any pressure receptable shall be in accordance with the requirements of the competent authority for the substance(s) contained therein.</p>		

Part 4 – Packing and tank provisions

P903	PACKING INSTRUCTION	P903
This instruction applies to UN Nos. 3090, 3091, 3480 and 3481.		
The following packagings are authorized provided that the general provisions of 4.1.1 and 4.1.3 are met:		
<p>(1) For cells and batteries:</p> <p style="padding-left: 40px;">Drums (1A2, 1B2, 1N2, 1H2, 1D, 1G);</p> <p style="padding-left: 40px;">Boxes (4A, 4B, 4N, 4C1, 4C2, 4D, 4F, 4G, 4H1, 4H2);</p> <p style="padding-left: 40px;">Jerricans (3A2, 3B2, 3H2).</p> <p>Cells or batteries shall be packed in packagings so that the cells or batteries are protected against damage that may be caused by the movement or placement of the cells or batteries within the packaging.</p> <p>Packagings shall conform to the packing group II performance level.</p>		
<p>(2) In addition for cells or batteries with a gross mass of 12 kg or more employing a strong, impact resistant outer casing, and assemblies of such cells or batteries:</p> <p>(a) Strong outer packagings, in protective enclosures (e.g., in fully enclosed or wooden slatted crates); or</p> <p>(b) Pallets or other handling devices.</p> <p>Cells or batteries shall be secured to prevent inadvertent movement, and the terminals shall not support the weight of other superimposed elements.</p> <p>Packagings need not meet the requirements of 4.1.1.3.</p>		
<p>(3) For cells or batteries packed with equipment:</p> <p>Packagings conforming to the requirements in paragraph (1) of this packing instruction, then placed with the equipment in an outer packaging; or</p> <p>Packagings that completely enclose the cells or batteries, then placed with equipment in a packaging conforming to the requirements in paragraph (1) of this packing instruction.</p> <p>The equipment shall be secured against movement within the outer packaging.</p> <p>For the purpose of this packing instruction, "equipment" means apparatus requiring the lithium metal or lithium ion cells or batteries with which it is packed for its operation.</p>		
<p>(4) For cells or batteries contained in equipment:</p> <p>Strong outer packagings constructed of suitable material, and of adequate strength and design in relation to the packaging capacity and its intended use. They shall be constructed in such a manner as to prevent accidental operation during transport. Packagings need not meet the requirements of 4.1.1.3.</p> <p>Large equipment can be offered for transport unpackaged or on pallets when the cells or batteries are afforded equivalent protection by the equipment in which they are contained.</p> <p>Devices such as radio frequency identification (RFID) tags, watches and temperature loggers, which are not capable of generating a dangerous evolution of heat, may be transported when intentionally active in strong outer packagings. When active, these devices shall meet defined standards for electromagnetic radiation to ensure that the operation of the device does not interfere with aircraft systems.</p>		
<p><b>Additional requirement:</b></p> <p>Cells or batteries shall be protected against short circuit.</p>		

P904	PACKING INSTRUCTION	P904
This instruction applies to UN 3245.		
<p>The following packagings are authorized:</p> <p>(1) Packagings meeting the provisions of 4.1.1.1, 4.1.1.2, 4.1.1.4, 4.1.1.8 and 4.1.3 and so designed that they meet the construction requirements of 6.1.4. Outer packagings constructed of suitable material, and of adequate strength and design in relation to the packaging capacity and its intended use, shall be used. Where this packing instruction is used for the transport of inner packagings of combination packagings the packaging shall be designed and constructed to prevent inadvertent discharge during normal conditions of transport.</p> <p>(2) Packagings, which need not conform to the packaging test requirements of part 6, but conforming to the following:</p> <p>(a) An inner packaging comprising:</p> <ul style="list-style-type: none"> <li>(i) primary receptacle(s) and a secondary packaging, the primary receptacle(s) or the secondary packaging shall be leakproof for liquids or siftproof for solids;</li> <li>(ii) for liquids, absorbent material placed between the primary receptacle(s) and the secondary packaging. The absorbent material shall be in a quantity sufficient to absorb the entire contents of the primary receptacle(s) so that any release of the liquid substance will not compromise the integrity of the cushioning material or of the outer packaging;</li> <li>(iii) if multiple fragile primary receptacles are placed in a single secondary packaging they shall be individually wrapped or separated to prevent contact between them;</li> </ul> <p>(b) An outer packaging shall be strong enough for its capacity, mass and intended use, and with a smallest external dimension of at least 100 mm.</p> <p>For transport, the mark illustrated below shall be displayed on the external surface of the outer packaging on a background of a contrasting colour and shall be clearly visible and legible. The mark shall be in the form of a square set at an angle of 45° (diamond-shaped) with each side having a length of at least 50 mm; the width of the line shall be at least 2 mm and the letters and numbers shall be at least 6 mm high.</p> <div style="text-align: center; margin: 20px 0;">  </div>		
<p><b>Additional requirement:</b> <i>Ice, dry ice and liquid nitrogen</i></p> <p>When dry ice or liquid nitrogen is used as a coolant, the requirements of 5.5.3 shall apply. When used, ice shall be placed outside the secondary packagings or in the outer packaging or an overpack. Interior supports shall be provided to secure the secondary packaging in the original position. If ice is used, the outside packaging or overpack shall be leakproof.</p>		

## Part 4 – Packing and tank provisions

P905	PACKING INSTRUCTION	P905
This instruction applies to UN 2990 and UN 3072.		
Any suitable packaging is authorized, provided the general provisions of 4.1.1 and 4.1.3 are met, except that packagings need not conform to the provisions of part 6. When the life-saving appliances are constructed to incorporate or are contained in rigid outer weatherproof casings (such as for lifeboats), they may be transported unpackaged.		
<b>Additional provisions:</b>		
1 All dangerous substances and articles contained as equipment within the appliances shall be secured to prevent inadvertent movement and in addition:		
(a) signal devices of class 1 shall be packed in plastics or fibreboard inner packagings;		
(b) gases (class 2.2) shall be contained in cylinders as specified by the competent authority, which may be connected to the appliance;		
(c) electric storage batteries (class 8) and lithium batteries (class 9) shall be disconnected or electrically isolated and secured to prevent any spillage of liquid; and		
(d) small quantities of other dangerous substances (for example in classes 3, 4.1 and 5.2) shall be packed in strong inner packagings.		
2 Preparation for transport and packaging shall include provisions to prevent any accidental inflation of the appliance.		

P906	PACKING INSTRUCTION	P906
This instruction applies to UN Nos. 2315, 3151, 3152 and 3432.		
The following packagings are authorized, provided the general provisions of 4.1.1 and 4.1.3 are met:		
(1) For liquids and solids containing or contaminated with PCBs or polyhalogenated biphenyls or terphenyls: Packagings in accordance with P001 or P002, as appropriate.		
(2) For transformers and condensers and other devices: Leakproof containment system which is capable of containing, in addition to the devices, at least 1.25 times the volume of the liquid PCBs, polyhalogenated biphenyls or terphenyls present in them. There shall be sufficient absorbent material in the packagings to absorb at least 1.1 times the volume of liquid which is contained in the devices. In general, transformers and condensers shall be transported in leakproof metal packagings which are capable of holding, in addition to the transformers and condensers, at least 1.25 times the volume of the liquid present in them.		
Notwithstanding the above, liquids and solids not packaged in accordance with P001 and P002 and unpackaged transformers and condensers may be transported in cargo transport units fitted with a leakproof metal tray to a height of at least 800 mm, containing sufficient inert absorbent material to absorb at least 1.1 times the volume of any free liquid.		
<b>Additional provision:</b>		
Adequate provisions shall be taken to seal the transformers and condensers to prevent leakage during normal conditions of transport.		

P907	PACKING INSTRUCTION	P907
If the machinery or apparatus is constructed and designed so that the receptacles containing the dangerous goods are afforded adequate protection, an outer packaging is not required. Dangerous goods in machinery or apparatus shall otherwise be packed in outer packagings constructed of suitable material, and of adequate strength and design in relation to the packaging capacity and its intended use, and meeting the applicable requirements of 4.1.1.1.		
Receptacles containing dangerous goods shall conform to the general provisions in 4.1.1, except that 4.1.1.3, 4.1.1.4, 4.1.1.12 and 4.1.1.14 do not apply. For class 2.2 gases, the inner cylinder or receptacle, its contents and filling density shall be to the satisfaction of the competent authority of the country in which the cylinder or receptacle is filled.		
In addition, the manner in which receptacles are contained within the machinery or apparatus shall be such that, under normal conditions of transport, damage to receptacles containing the dangerous goods is unlikely; and in the event of damage to the receptacles containing solid or liquid dangerous goods, no leakage of the dangerous goods from the machinery or apparatus is possible (a leakproof liner may be used to satisfy this requirement). Receptacles containing dangerous goods shall be so installed, secured or cushioned as to prevent their breakage or leakage and so as to control their movement within the machinery or apparatus during normal conditions of transport. Cushioning material shall not react dangerously with the content of the receptacles. Any leakage of the contents shall not substantially impair the protective properties of the cushioning material.		

## 4.1.4.2 Packing instructions concerning the use of IBCs

IBC01	PACKING INSTRUCTION	IBC01
The following IBCs are authorized, provided the general provisions of 4.1.1, 4.1.2 and 4.1.3 are met: Metal (31A, 31B and 31N).		

Chapter 4.1 – Use of packagings, including IBCs and large packagings

IBC02	PACKING INSTRUCTION	IBC02
The following IBCs are authorized, provided the general provisions of 4.1.1, 4.1.2 and 4.1.3 are met:		
<ul style="list-style-type: none"> <li>(1) Metal (31A, 31B and 31N);</li> <li>(2) Rigid plastics (31H1 and 31H2);</li> <li>(3) Composite (31HZ1).</li> </ul>		
<b>Special packing provisions:</b>		
<b>B5</b>	For UN Nos. 1791, 2014, 2984 and 3149, IBCs shall be provided with a device to allow venting during transport. The inlet to the venting device shall be sited in the vapour space of the IBC under maximum filling conditions during transport.	
<b>B8</b>	The pure form of this substance shall not be transported in IBCs since it is known to have a vapour pressure of more than 110 kPa at 50°C or 130 kPa at 55°C.	
<b>B15</b>	For UN 2031 with more than 55% nitric acid, the permitted use of rigid plastics IBCs and of composite IBCs with a rigid plastics inner receptacle shall be two years from their date of manufacture.	
<b>B20</b>	For UN Nos. 1716, 1717, 1736, 1737, 1738, 1742, 1743, 1755, 1764, 1768, 1776, 1778, 1782, 1789, 1790, 1796, 1826, 1830, 1832, 2031, 2308, 2353, 2513, 2584, 2796 and 2817 coming under PG II, IBCs shall be fitted with two shut-off devices.	

IBC03	PACKING INSTRUCTION	IBC03
The following IBCs are authorized, provided the general provisions of 4.1.1, 4.1.2 and 4.1.3 are met:		
<ul style="list-style-type: none"> <li>(1) Metal (31A, 31B and 31N);</li> <li>(2) Rigid plastics (31H1 and 31H2);</li> <li>(3) Composite (31HZ1 and 31HA2, 31HB2, 31HN2, 31HD2 and 31HZ2).</li> </ul>		
<b>Special packing provisions:</b>		
<b>B8</b>	The pure form of this substance shall not be transported in IBCs since it is known to have a vapour pressure of more than 110 kPa at 50°C or 130 kPa at 55°C.	
<b>B11</b>	Notwithstanding the provisions of 4.1.1.10, UN 2672 ammonia solution in concentrations not exceeding 25% may be transported in rigid or composite plastics IBCs (31H1, 31H2 and 31HZ1).	

IBC04	PACKING INSTRUCTION	IBC04
The following IBCs are authorized, provided the general provisions of 4.1.1, 4.1.2 and 4.1.3 are met:		
Metal (11A, 11B, 11N, 21A, 21B and 21N).		
<b>Special packing provision:</b>		
<b>B1</b>	For packing group I substances, IBCs shall be carried in closed cargo transport units or in freight containers/vehicles, which shall have rigid sides or fences at least to the height of the IBC.	

IBC05	PACKING INSTRUCTION	IBC05
The following IBCs are authorized, provided the general provisions of 4.1.1, 4.1.2 and 4.1.3 are met:		
<ul style="list-style-type: none"> <li>(1) Metal (11A, 11B, 11N, 21A, 21B and 21N);</li> <li>(2) Rigid plastics (11H1, 11H2, 21H1 and 21H2);</li> <li>(3) Composite (11HZ1 and 21HZ1).</li> </ul>		
<b>Special packing provisions:</b>		
<b>B1</b>	For packing group I substances, IBCs shall be carried in closed cargo transport units or in freight containers/vehicles, which shall have rigid sides or fences at least to the height of the IBC.	
<b>B2</b>	For solid substances in IBCs other than metal or rigid plastics IBCs, the IBCs shall be carried in closed cargo transport units or in freight containers/vehicles, which shall have rigid sides or fences at least to the height of the IBC.	

IBC06	PACKING INSTRUCTION	IBC06
The following IBCs are authorized, provided the general provisions of 4.1.1, 4.1.2 and 4.1.3 are met:		
<ul style="list-style-type: none"> <li>(1) Metal (11A, 11B, 11N, 21A, 21B and 21N);</li> <li>(2) Rigid plastics (11H1, 11H2, 21H1 and 21H2);</li> <li>(3) Composite (11HZ1, 11HZ2, 21HZ1 and 21HZ2).</li> </ul>		
<b>Additional provision:</b>		
Where the solid may become liquid during transport see 4.1.3.4.		
<b>Special packing provisions:</b>		
<b>B1</b>	For packing group I substances, IBCs shall be carried in closed cargo transport units or in freight containers/vehicles, which shall have rigid sides or fences at least to the height of the IBC.	
<b>B2</b>	For solid substances in IBCs other than metal or rigid plastics IBCs, the IBCs shall be carried in closed cargo transport units or in freight containers/vehicles, which shall have rigid sides or fences at least to the height of the IBC.	
<b>B12</b>	For UN 2907, IBCs shall meet the packing group II performance level. IBCs meeting the test criteria of packing group I shall not be used.	

Part 4 – Packing and tank provisions

IBC07	PACKING INSTRUCTION	IBC07
The following IBCs are authorized, provided the general provisions of 4.1.1, 4.1.2 and 4.1.3 are met:		
(1) Metal (11A, 11B, 11N, 21A, 21B and 21N); (2) Rigid plastics (11H1, 11H2, 21H1 and 21H2); (3) Composite (11HZ1, 11HZ2, 21HZ1 and 21HZ2); (4) Wooden (11C, 11D and 11F).		
<b>Additional provision:</b>		
1 Where the solid may become liquid during transport see 4.1.3.4.		
2 Liners of wooden IBCs shall be sift-proof.		
<b>Special packing provisions:</b>		
<b>B1</b>	For packing group I substances, IBCs shall be carried in closed cargo transport units or in freight containers/vehicles, which shall have rigid sides or fences at least to the height of the IBC.	
<b>B2</b>	For solid substances in IBCs other than metal or rigid plastics IBCs, the IBCs shall be carried in closed cargo transport units or in freight containers/vehicles, which shall have rigid sides or fences at least to the height of the IBC.	
<b>B4</b>	Flexible, fibreboard or wooden IBCs shall be sift-proof and water-resistant or shall be fitted with a sift-proof and water-resistant liner.	

IBC08	PACKING INSTRUCTION	IBC08
The following IBCs are authorized, provided the general provisions of 4.1.1, 4.1.2 and 4.1.3 are met:		
(1) Metal (11A, 11B, 11N, 21A, 21B and 21N); (2) Rigid plastics (11H1, 11H2, 21H1 and 21H2); (3) Composite (11HZ1, 11HZ2, 21HZ1 and 21HZ2); (4) Fibreboard (11G); (5) Wooden (11C, 11D and 11F); (6) Flexible (13H1, 13H2, 13H3, 13H4, 13H5, 13L1, 13L2, 13L3, 13L4, 13M1 or 13M2).		
<b>Additional provision:</b>		
Where the solid may become liquid during transport see 4.1.3.4.		
<b>Special packing provisions:</b>		
<b>B2</b>	For substances, UN 1374 and UN 2590 in IBCs other than metal or rigid plastics IBCs, the IBCs shall be carried in closed cargo transport units or in freight containers/vehicles, which shall have rigid sides or fences at least to the height of the IBC.	
<b>B3</b>	Flexible IBCs shall be sift-proof and water-resistant or shall be fitted with a sift-proof and water-resistant liner.	
<b>B4</b>	Flexible, fibreboard or wooden IBCs shall be sift-proof and water-resistant or shall be fitted with a sift-proof and water-resistant liner.	
<b>B6</b>	For UN Nos. 1327, 1363, 1364, 1365, 1386, 1408, 1841, 2211, 2217, 2793 and 3314, IBCs are not required to meet the IBC testing provisions of chapter 6.5.	

IBC99	PACKING INSTRUCTION	IBC99
Only IBCs which are approved for these goods by the competent authority may be used (see 4.1.3.7). A copy of the competent authority approval shall accompany each consignment or the transport document shall include an indication that the packaging was approved by the competent authority.		

IBC100	PACKING INSTRUCTION	IBC100
This instruction applies to UN Nos. 0082, 0241, 0331 and 0332.		
The following IBCs are authorized, provided the general provisions of 4.1.1, 4.1.2 and 4.1.3 and special provisions of 4.1.5 are met:		
(1) Metal (11A, 11B, 11N, 21A, 21B, 21N, 31A, 31B and 31N); (2) Flexible (13H2, 13H3, 13H4, 13L2, 13L3, 13L4 and 13M2); (3) Rigid plastics (11H1, 11H2, 21H1, 21H2, 31H1 and 31H2); (4) Composite (11HZ1, 11HZ2, 21HZ1, 21HZ2, 31HZ1 and 31HZ2).		
<b>Additional provisions:</b>		
1 IBCs shall only be used for free-flowing substances.		
2 Flexible IBCs shall only be used for solids.		
<b>Special packing provisions:</b>		
<b>B9</b>	For UN 0082, this packing instruction may only be used when the substances are mixtures of ammonium nitrate or other inorganic nitrates with other combustible substances which are not explosive ingredients. Such explosives shall not contain nitroglycerin, similar liquid organic nitrates, or chlorates. Metal IBCs are not authorized.	
<b>B10</b>	For UN 0241, this packing instruction may only be used for substances which consist of water as an essential ingredient and high proportions of ammonium nitrate or other oxidizing substances, some or all of which are in solution. The other constituents may include hydrocarbons or aluminium powder, but shall not include nitro-derivatives such as trinitrotoluene. Metal IBCs are not authorized.	



Chapter 4.1 – Use of packagings, including IBCs and large packagings

IBC520		PACKING INSTRUCTION			IBC520	
This instruction applies to organic peroxides and self-reactive substances of type F.						
The IBCs listed below are authorized for the formulations listed, provided the general provisions of 4.1.1, 4.1.2 and 4.1.3 and special provisions of 4.1.7.2 are met.						
For formulations not listed below, only IBCs which are approved by the competent authority may be used (see 4.1.7.2.2).						
UN No.	Organic peroxide	Type of IBC	Maximum quantity (litres)	Control temperature	Emergency temperature	
3109	<b>ORGANIC PEROXIDE TYPE F, LIQUID</b>					
	<i>tert</i> -Butyl hydroperoxide, not more than 72% with water	31A	1250			
	<i>tert</i> -Butyl peroxyacetate, not more than 32% in diluent type A	31HA1	1000			
	<i>tert</i> -Butyl peroxybenzoate, not more than 32% in diluent type A	31A	1250			
	<i>tert</i> -Butyl peroxy-3,5,5-trimethylhexanoate, not more than 37% in diluent type A	31A 31HA1	1250 1000			
	Cumyl hydroperoxide, not more than 90% in diluent type A	31HA1	1250			
	Dibenzoyl peroxide, not more than 42% as a stable dispersion	31H1	1000			
	Di- <i>tert</i> -butyl peroxide, not more than 52% in diluent type A	31A 31HA1	1250 1000			
	1,1-Di-( <i>tert</i> -butylperoxy)cyclohexane, not more than 37% in diluent type A	31A	1250			
	1,1-Di-( <i>tert</i> -butylperoxy)cyclohexane, not more than 42% in diluent type A	31H1	1000			
	Dilauroyl peroxide, not more than 42%, stable dispersion, in water	31HA1	1000			
	Isopropylcumyl hydroperoxide, not more than 72% in diluent type A	31HA1	1250			
	<i>p</i> -Menthyl hydroperoxide, not more than 72% in diluent type A	31HA1	1250			
Peroxyacetic acid, stabilized, not more than 17%	31H1 31H2 31HA1 31A	1500 1500 1500 1500				
3110	<b>ORGANIC PEROXIDE TYPE F, SOLID</b> Dicumyl peroxide	31A 31H1 31HA1	2000			
3119	<b>ORGANIC PEROXIDE TYPE F, LIQUID, TEMPERATURE CONTROLLED</b>					
	<i>tert</i> -Amyl peroxy-pivalate, not more than 32% in diluent type A	31A	1250	+10°C	+15°C	
	<i>tert</i> -Butyl peroxy-2-ethylhexanoate, not more than 32% in diluent type B	31HA1 31A	1000 1250	+30°C +30°C	+35°C +35°C	
	<i>tert</i> -Butyl peroxyneodecanoate, not more than 32% in diluent type A	31A	1250	0°C	+10°C	
	<i>tert</i> -Butyl peroxyneodecanoate, not more than 42%, stable dispersion, in water	31A	1250	-5°C	+5°C	
	<i>tert</i> -Butyl peroxyneodecanoate, not more than 52%, stable dispersion, in water	31A	1250	-5°C	+5°C	
	<i>tert</i> -Butyl peroxy-pivalate, not more than 27% in diluent type B	31HA1 31A	1000 1250	+10°C +10°C	+15°C +15°C	
	Di-(2-neodecanoylperoxyisopropyl)benzene, not more than 42%, stable dispersion, in water	31A	1250	-15°C	-5°C	
	3-Hydroxy-1,1-dimethylbutyl peroxyneodecanoate, not more than 52%, stable dispersion, in water	31A	1250	-15°C	-5°C	
	Cumyl peroxyneodecanoate, not more than 52%, stable dispersion, in water	31A	1250	-15°C	-5°C	
	Di-(4- <i>tert</i> -butylcyclohexyl) peroxydicarbonate, not more than 42%, stable dispersion, in water	31HA1	1000	+30°C	+35°C	
	Dicetyl peroxydicarbonate, not more than 42%, stable dispersion, in water	31HA1	1000	+30°C	+35°C	
	Dicyclohexyl peroxydicarbonate, not more than 42% as a stable dispersion, in water	31A	1250	+10°C	+15°C	
Di-(2-ethylhexyl) peroxydicarbonate, not more than 62%, stable dispersion, in water	31A	1250	-20°C	-10°C		

Part 4 – Packing and tank provisions

IBC520		PACKING INSTRUCTION (continued)				IBC520
UN No.	Organic peroxide	Type of IBC	Maximum quantity (litres)	Control temperature	Emergency temperature	
3119 (cont.)	<b>ORGANIC PEROXIDE TYPE F, LIQUID, TEMPERATURE CONTROLLED (continued)</b>					
	Dimyristyl peroxydicarbonate, not more than 42%, stable dispersion, in water	31HA1	1000	+15°C	+20°C	
	Di-(3,5,5-trimethylhexanoyl) peroxide, not more than 52% in diluent type A	31HA1 31A	1000 1250	+10°C +10°C	+15°C +15°C	
	Di-(3,5,5-trimethylhexanoyl) peroxide, not more than 52%, stable dispersion, in water	31A	1250	+10°C	+15°C	
	<i>Diisobutyryl peroxide, not more than 28% as a stable dispersion in water</i>	31HA1 31A	1 000 1 250	-20°C -20 °C	-10°C -10 °C	
	<i>Diisobutyryl peroxide, not more than 42% as a stable dispersion in water</i>	31HA1 31A	1 000 1 250	-25°C -25 °C	-15°C -15 °C	
	1,1,3,3-Tetramethylbutyl peroxyneodecanoate, not more than 52%, stable dispersion, in water	31A 31HA1	1250 1000	-5°C -5°C	+5°C +5°C	
3120	<b>ORGANIC PEROXIDE, TYPE F, SOLID, TEMPERATURE CONTROLLED</b>					
<b>Additional provisions:</b>						
1 IBCs shall be provided with a device to allow venting during transport. The inlet to the pressure relief device shall be sited in the vapour space of the IBC under maximum filling conditions during transport.						
2 To prevent explosive rupture of metal IBCs or composite IBCs with complete metal casing, the emergency relief devices shall be designed to vent all the decomposition products and vapours evolved during self-accelerating decomposition or during a period of not less than one hour of fire-engulfment as calculated by the formula in 4.2.1.13.8. The control and emergency temperatures specified in this packing instruction are based on a non-insulated IBC. When consigning an organic peroxide in an IBC in accordance with this instruction, it is the responsibility of the consignor to ensure that:						
(a) the pressure and emergency relief devices installed on the IBC are designed to take appropriate account of the self-accelerating decomposition of the organic peroxide and of fire engulfment; and						
(b) when applicable, the control and emergency temperatures indicated are appropriate, taking into account the design (such as insulation) of the IBC to be used.						

IBC620		PACKING INSTRUCTION		IBC620
This instruction applies to UN 3291.				
The following IBCs are authorized, provided that the general provisions of 4.1.1, except 4.1.1.15, 4.1.2 and 4.1.3 are met: Rigid, leakproof IBCs conforming to the packing group II performance level.				
<b>Additional provisions:</b>				
1 There shall be sufficient absorbent material to absorb the entire amount of liquid present in the IBC.				
2 IBCs shall be capable of retaining liquids.				
3 IBCs intended to contain sharp objects such as broken glass and needles shall be resistant to puncture.				

4.1.4.3 Packing instructions concerning the use of large packagings

LP01		PACKING INSTRUCTION (LIQUIDS)			LP01
The following large packagings are authorized, provided the general provisions of 4.1.1 and 4.1.3 are met.					
Inner packagings	Large outer packagings	Packing group I	Packing group II	Packing group III	
Glass 10 ℓ	Steel (50A)	Not allowed	Not allowed	3 m <sup>3</sup>	
Plastics 30 ℓ	Aluminium (50B)				
Metal 40 ℓ	Metal other than steel or aluminium (50N)				
	Rigid plastics (50H)				
	Natural wood (50C)				
	Plywood (50D)				
	Reconstituted wood (50F)				
	Rigid fibreboard (50G)				

Chapter 4.1 – Use of packagings, including IBCs and large packagings

LP02 PACKING INSTRUCTION (SOLIDS) LP02				
The following large packagings are authorized, provided the general provisions of 4.1.1 and 4.1.3 are met.				
Inner packagings	Large outer packagings	Packing group I	Packing group II	Packing group III
Glass 10 kg Plastics <sup>2</sup> 50 kg Metal 50 kg Paper <sup>1, 2</sup> 50 kg Fibre <sup>1, 2</sup> 50 kg	Steel (50A) Aluminium (50B) Metal other than steel or aluminium (50N) Rigid plastics (50H) Natural wood (50C) Plywood (50D) Reconstituted wood (50F) Rigid fibreboard (50G) Flexible plastics (51H) <sup>3</sup>	Not allowed	Not allowed	3 m <sup>3</sup>
<sup>1</sup> These packagings shall not be used when the substances being transported may become liquid during transport.				
<sup>2</sup> Packagings shall be sift-proof.				
<sup>3</sup> To be used with flexible inner packagings only.				
<b>Special packing provision:</b>				
<b>L2</b> For UN 1950 aerosols, the large packaging shall meet the packing group III performance level. Large packagings for waste aerosols transported in accordance with special provision 327 shall have in addition a means of retaining any free liquid that might escape during transport, e.g., absorbent material.				

LP99 PACKING INSTRUCTION LP99	
Only packagings which are approved for these goods by the competent authority may be used (see 4.1.3.7). A copy of the competent authority approval shall accompany each consignment or the transport document shall include an indication that the packaging was approved by the competent authority.	

LP101 PACKING INSTRUCTION LP101		
The following packagings are authorized, provided the general provisions of 4.1.1 and 4.1.3 and special provisions of 4.1.5 are met.		
Inner packagings	Intermediate packagings	Large packagings
<i>Not necessary</i>	<i>Not necessary</i>	Steel (50A) Aluminium (50B) Metal other than steel or aluminium (50N) Rigid plastics (50H) Natural wood (50C) Plywood (50D) Reconstituted wood (50F) Rigid fibreboard (50G)
<b>Special packing provision:</b>		
<b>L1</b> For UN Nos. 0006, 0009, 0010, 0015, 0016, 0018, 0019, 0034, 0035, 0038, 0039, 0048, 0056, 0137, 0138, 0168, 0169, 0171, 0181, 0182, 0183, 0186, 0221, 0243, 0244, 0245, 0246, 0254, 0280, 0281, 0286, 0287, 0297, 0299, 0300, 0301, 0303, 0321, 0328, 0329, 0344, 0345, 0346, 0347, 0362, 0363, 0370, 0412, 0424, 0425, 0434, 0435, 0436, 0437, 0438, 0451, 0488 and 0502: Large and robust explosives articles, normally intended for military use, without their means of initiation or with their means of initiation containing at least two effective protective features, may be transported unpackaged. When such articles have propelling charges or are self-propelled, their ignition systems shall be protected against stimuli encountered during normal conditions of transport. A negative result in Test Series 4 on an unpackaged article indicates that the article can be considered for transport unpackaged. Such unpackaged articles may be fixed to cradles or contained in crates or other suitable handling devices.		

Part 4 – Packing and tank provisions

LP102	PACKING INSTRUCTION		LP102
The following packagings are authorized, provided the general provisions of 4.1.1 and 4.1.3 and special provisions of 4.1.5 are met.			
	Inner packagings	Intermediate packagings	Outer packagings
	<b>Bags</b> water-resistant  <b>Receptacles</b> fibreboard metal plastics wood  <b>Sheets</b> fibreboard, corrugated  <b>Tubes</b> fibreboard	<i>Not necessary</i>	Steel (50A) Aluminium (50B) Metal other than steel or aluminium (50N) Rigid plastics (50H) Natural wood (50C) Plywood (50D) Reconstituted wood (50F) Rigid fibreboard (50G)

LP621	PACKING INSTRUCTION	LP621
This instruction applies to UN 3291.		
The following large packagings are authorized, provided the general provisions of 4.1.1 and 4.1.3 are met:		
(1) For clinical waste placed in inner packagings: Rigid, leakproof large packagings conforming to the provisions of chapter 6.6 for solids, at the packing group II performance level, provided there is sufficient absorbent material to absorb the entire amount of liquid present and the large packaging is capable of retaining liquids. (2) For packages containing larger quantities of liquid: Large rigid packagings conforming to the provisions of chapter 6.6, at the packing group II performance level, for liquids.		
<b>Additional provision:</b>		
Large packagings intended to contain sharp objects such as broken glass and needles shall be resistant to puncture and retain liquids under the performance test conditions in chapter 6.6.		

LP902	PACKING INSTRUCTION	LP902
This instruction applies to UN 3268.		
Packaged articles:		
The following packagings are authorized, provided the general provisions of 4.1.1 and 4.1.3 are met:		
Packagings conforming to the packing group III performance level. The packagings shall be designed and constructed to prevent movement of the articles and inadvertent operation during normal conditions of transport.		
Unpackaged articles:		
The articles may also be transported unpackaged in dedicated handling devices, vehicles, containers or wagons when moved from where they are manufactured to an assembly plant.		
<b>Additional provision:</b>		
Any pressure receptacle shall be in accordance with the requirements of the competent authority for the substance(s) contained in the pressure receptacle(s).		

## 4.1.5 Special packing provisions for goods of class 1

4.1.5.1 The general provisions of 4.1.1 shall be met.

4.1.5.2 All packagings for class 1 goods shall be so designed and constructed that:

- .1 they will protect the explosives, prevent them escaping and cause no increase in the risk of unintended ignition or initiation when subjected to normal conditions of transport, including foreseeable changes in temperature, humidity and pressure;
- .2 the complete package can be handled safely in normal conditions of transport; and
- .3 the packages will withstand any loading imposed on them by foreseeable stacking to which they will be subject during transport so that they do not add to the risk presented by the explosives, the containment function of the packagings is not harmed, and they are not distorted in a way or to an extent which will reduce their strength or cause instability of a stack.

4.1.5.3 All explosive substances and articles, as prepared for transport, shall have been classified in accordance with the procedures detailed in 2.1.3.

4.1.5.4 Class 1 goods shall be packed in accordance with the appropriate packing instruction shown in columns 8 and 9 of the Dangerous Goods List, as detailed in 4.1.4.

- 4.1.5.5 Unless otherwise specified in this Code, packagings, including IBCs and large packagings, shall conform to the requirements of chapters 6.1, 6.5 or 6.6, as appropriate, and shall meet their test provisions for packing group II.
- 4.1.5.6 The closure device of packagings containing liquid explosives shall ensure a double protection against leakage.
- 4.1.5.7 The closure device of metal drums shall include a suitable gasket; if a closure device includes a screw-thread, the ingress of explosive substances into the screw-thread shall be prevented.
- 4.1.5.8 Packagings for water-soluble substances shall be water-resistant. Packagings for desensitized or phlegmatized substances shall be closed to prevent changes in concentration during transport.
- 4.1.5.9 When the packaging includes a double envelope filled with water which may freeze during transport, a sufficient quantity of an anti-freeze agent shall be added to the water to prevent freezing. Anti-freeze that could create a fire hazard because of its inherent flammability shall not be used.
- 4.1.5.10 Nails, staples and other closure devices made of metal without protective covering shall not penetrate to the inside of the outer packaging unless the inner packaging adequately protects the explosives against contact with the metal.
- 4.1.5.11 Inner packagings, fittings and cushioning materials and the placing of explosive substances or articles in packages shall be accomplished in a manner which prevents the explosive substances or articles from becoming loose in the outer packaging under normal conditions of transport. Metallic components of articles shall be prevented from making contact with metal packagings. Articles containing explosive substances not enclosed in an outer casing shall be separated from each other in order to prevent friction and impact. Padding, trays, partitioning in the inner or outer packaging, mouldings or receptacles may be used for this purpose.
- 4.1.5.12 Packagings shall be made of materials compatible with, and impermeable to, the explosives contained in the package, so that neither interaction between the explosives and the packaging materials nor leakage causes the explosive to become unsafe to transport, or the hazard division or compatibility group to change.
- 4.1.5.13 The ingress of explosive substances into the recesses of seamed metal packagings shall be prevented.
- 4.1.5.14 Plastics packagings shall not be liable to generate or accumulate sufficient static electricity so that a discharge could cause the packaged explosive substances or articles to initiate, ignite or function.
- 4.1.5.15 Large and robust explosives articles, normally intended for military use, without their means of initiation or with their means of initiation containing at least two effective protective features may be transported unpackaged. When such articles have propelling charges or are self-propelled, their ignition systems shall be protected against stimuli encountered during normal conditions of transport. A negative result in Test Series 4 on an unpackaged article indicates that the article can be considered for transport unpackaged. Such unpackaged articles may be fixed to cradles or contained in crates or other suitable handling, storage or launching devices in such a way that they will not become loose during normal conditions of transport. Where such large explosive articles are, as part of their operational safety and suitability tests, subjected to test regimes that meet the provisions of this Code and such tests have been successfully undertaken, the competent authority may approve such articles to be transported under this Code.
- 4.1.5.16 Explosive substances shall not be packed in inner or outer packagings where the differences in internal and external pressures, due to thermal or other effects, could cause an explosion or rupture of the package.
- 4.1.5.17 Whenever loose explosive substances or the explosive substance of an uncased or partly cased article may come into contact with the inner surface of metal packagings (1A1, 1A2, 1B1, 1B2, 4A, 4B and metal receptacles), the metal packaging shall be provided with an inner liner or coating (see 4.1.1.2).
- 4.1.5.18 Packing instruction P101 may be used for any explosive provided the package has been approved by a competent authority regardless of whether the packaging complies with the packing instruction assignment in the Dangerous Goods List.
- 4.1.5.19 Government-owned military dangerous goods, packaged prior to 1 January 1990 in accordance with the provisions of the IMDG Code in effect at that time, may be transported provided the packagings maintain their integrity and the goods are declared as government-owned goods packaged prior to 1 January 1990.
- 4.1.6 Special packing provisions for goods of class 2**
- 4.1.6.1 General provisions**
- 4.1.6.1.1 This section provides general requirements applicable to the use of pressure receptacles for the transport of class 2 gases and other dangerous goods in pressure receptacles (e.g. UN 1051 Hydrogen cyanide, stabilized). Pressure receptacles shall be constructed and closed so as to prevent any loss of contents which might be caused under normal conditions of transport, including by vibration, or by changes in temperature, humidity or pressure (resulting from change in altitude, for example).

## Part 4 – Packing and tank provisions

- 4.1.6.1.2 Parts of pressure receptacles which are in direct contact with dangerous goods shall not be affected or weakened by those dangerous goods and shall not cause a dangerous effect (e.g. catalysing a reaction or reacting with the dangerous goods). The provisions of ISO 11114-1:1997 and ISO 11114-2:2000 shall be met as applicable.
- 4.1.6.1.3 Pressure receptacles, including their closures, shall be selected to contain a gas or a mixture of gases according to the requirements of 6.2.1.2 and the requirements of the specific packing instructions of 4.1.4.1. This section also applies to pressure receptacles which are elements of MEGCs.
- 4.1.6.1.4 Refillable pressure receptacles shall not be filled with a gas or gas mixture different from that previously contained unless the necessary operations for change of gas service have been performed. The change of service for compressed and liquefied gases shall be in accordance with ISO 11621:1997, as applicable. In addition, a pressure receptacle that previously contained a class 8 corrosive substance or a substance of another class with a corrosive subsidiary risk shall not be authorized for the transport of a class 2 substance unless the necessary inspection and testing as specified in 6.2.1.6 have been performed.
- 4.1.6.1.5 Prior to filling, the filler shall perform an inspection of the pressure receptacle and ensure that the pressure receptacle is authorized for the gas and, in case of a chemical under pressure, for the propellant to be transported and that the provisions of this Code have been met. Shut-off valves shall be closed after filling and remain closed during transport. The consignor shall verify that the closures and equipment are not leaking.
- 4.1.6.1.6 Pressure receptacles shall be filled according to the working pressures, filling ratios and provisions specified in the appropriate packing instruction for the specific substance being filled. Reactive gases and gas mixtures shall be filled to a pressure such that if complete decomposition of the gas occurs, the working pressure of the pressure receptacle shall not be exceeded. Bundles of cylinders shall not be filled in excess of the lowest working pressure of any given cylinder in the bundle.
- 4.1.6.1.7 Pressure receptacles, including their closures, shall conform to the design, construction, inspection and testing requirements detailed in chapter 6.2. When outer packagings are prescribed, the pressure receptacles shall be firmly secured therein. Unless otherwise specified in the detailed packing instructions, one or more inner packagings may be enclosed in an outer packaging.
- 4.1.6.1.8 Valves shall be designed and constructed in such a way that they are inherently able to withstand damage without release of the contents or shall be protected from damage which could cause inadvertent release of the contents of the pressure receptacle, by one of the following methods:
- .1 Valves are placed inside the neck of the pressure receptacle and protected by a threaded plug or cap;
  - .2 Valves are protected by caps. Caps shall possess vent-holes of sufficient cross-sectional area to evacuate the gas if leakage occurs at the valves;
  - .3 Valves are protected by shrouds or guards;
  - .4 Pressure receptacles are transported in frames (e.g. bundles); or
  - .5 Pressure receptacles are transported in an outer packaging. The packaging as prepared for transport shall be capable of meeting the drop test specified in 6.1.5.3 at the packing group I performance level.
- For pressure receptacles with valves as described in .2 and .3, the requirements of either ISO 11117:1998 or ISO 11117:2008 + Cor 1:2009 shall be met; for valves with inherent protection, the provisions of annex A of ISO 10297:2006 shall be met.
- For metal hydride storage systems, the valve protection requirements specified in ISO 16111:2008 shall be met.
- 4.1.6.1.9 Non-refillable pressure receptacles shall:
- .1 be transported in an outer packaging, such as a box, or crate, or in shrink-wrapped trays or stretch-wrapped trays;
  - .2 be of a water capacity less than or equal to 1.25 ℓ when filled with flammable or toxic gas;
  - .3 not be used for toxic gases with an LC<sub>50</sub> less than or equal to 200 ml/m<sup>3</sup>; and
  - .4 not be repaired after being put into service.
- 4.1.6.1.10 Refillable pressure receptacles, other than cryogenic receptacles, shall be periodically inspected in accordance with 6.2.1.6 and packing instruction P200, P205 or P206, as applicable. Pressure relief valves for closed cryogenic receptacles shall be subject to periodic inspections and tests according to the provisions of 6.2.1.6.3 and packing instruction P203. Pressure receptacles shall not be filled after they become due for periodic inspection but may be transported after the expiry of the time limit.
- 4.1.6.1.11 Repairs shall be consistent with the manufacture and testing requirements of the applicable design and construction standards and are only permitted as indicated in the relevant periodic inspection standards specified in 6.2.2.4. Pressure receptacles, other than the jacket of closed cryogenic receptacles, shall not be subjected to repairs of any of the following:
- .1 weld cracks or other weld defects;

- .2 cracks in walls;
  - .3 leaks or defects in the material of the wall, head or bottom.
- 4.1.6.1.12** Pressure receptacles shall not be offered for filling:
- .1 when damaged to such an extent that the integrity of the pressure receptacle or its service equipment may be affected;
  - .2 unless the pressure receptacle and its service equipment has been examined and found to be in good working order; or
  - .3 unless the required certification, retest, and filling markings are legible.
- 4.1.6.1.13** Filled pressure receptacles shall not be offered for transport:
- .1 when leaking;
  - .2 when damaged to such an extent that the integrity of the pressure receptacle or its service equipment may be affected;
  - .3 unless the pressure receptacle and its service equipment has been examined and found to be in good working order; or
  - .4 unless the required certification, retest, and filling markings are legible.
- 4.1.6.1.14** Where in packing instruction P200 cylinders and other pressure receptacles for gases conforming to the requirements of this sub-section and chapter 6.2 are authorized, use is also authorized of cylinders and pressure receptacles which conform to the requirements of the competent authority of the country in which the cylinder or pressure receptacle is filled. Valves shall be suitably protected. Pressure receptacles with capacities of 1 ℓ or less shall be packed in outer packagings constructed of suitable material of adequate strength and design in relation to the capacity of the packaging and its intended use and secured or cushioned so as to prevent significant movement within the outer packaging during normal conditions of transport.
- 4.1.7 Special packing provisions for organic peroxides (class 5.2) and self-reactive substances of class 4.1**
- 4.1.7.0 General**
- 4.1.7.0.1** For organic peroxides, all receptacles shall be “effectively closed”. Where significant internal pressure may develop in a package by the evolution of gas, a vent may be fitted, provided the gas emitted will not cause danger, otherwise the degree of filling shall be limited. Any venting device shall be so constructed that liquid will not escape when the package is in an upright position and it shall be able to prevent ingress of impurities. The outer packaging, if any, shall be so designed as not to interfere with the operation of the venting device.
- 4.1.7.1 Use of packagings (except IBCs)**
- 4.1.7.1.1** Packagings for organic peroxides and self-reactive substances shall conform to the provisions of chapter 6.1 and shall meet its test provisions for packing group II.
- 4.1.7.1.2** The packing methods for organic peroxides and self-reactive substances are listed in packing instruction P520 and are designated OP1 to OP8. The quantities specified for each packing method are the maximum quantities authorized per package.
- 4.1.7.1.3** The packing methods appropriate for the individual currently assigned self-reactive substances and organic peroxides are listed in 2.4.2.3.2.3 and 2.5.3.2.4.
- 4.1.7.1.4** For new organic peroxides, new self-reactive substances or new formulations of currently assigned organic peroxides or self-reactive substances, the following procedure shall be used to assign the appropriate packing method:
- .1 **ORGANIC PEROXIDE TYPE B or SELF-REACTIVE SUBSTANCE TYPE B:**  
Packing method OP5 shall be assigned, provided that the organic peroxide (or self-reactive substance) satisfies the criteria of 2.5.3.3.2.2 (resp. 2.4.2.3.3.2.2) in a packaging authorized by the packing method. If the organic peroxide (or self-reactive substance) can only satisfy these criteria in a smaller packaging than those authorized by packing method OP5 (viz. one of the packagings listed for OP1 to OP4), then the corresponding packing method with the lower OP number is assigned;
  - .2 **ORGANIC PEROXIDE TYPE C or SELF-REACTIVE SUBSTANCE TYPE C:**  
Packing method OP6 shall be assigned, provided that the organic peroxide (or self-reactive substance) satisfies the criteria of 2.5.3.3.2.3 (resp. 2.4.2.3.3.2.3) in packaging authorized by the packing method. If the organic peroxide (or self-reactive substance) can only satisfy these criteria in a smaller packaging than those authorized by packing method OP6, then the corresponding packing method with the lower OP number is assigned;

## Part 4 – Packing and tank provisions

- .3 ORGANIC PEROXIDE TYPE D or SELF-REACTIVE SUBSTANCE TYPE D:  
Packing method OP7 shall be assigned to this type of organic peroxide or self-reactive substance;
- .4 ORGANIC PEROXIDE TYPE E or SELF-REACTIVE SUBSTANCE TYPE E:  
Packing method OP8 shall be assigned to this type of organic peroxide or self-reactive substance;
- .5 ORGANIC PEROXIDE TYPE F or SELF-REACTIVE SUBSTANCE TYPE F:  
Packing method OP8 shall be assigned to this type of organic peroxide or self-reactive substance.

## 4.1.7.2 Use of intermediate bulk containers

4.1.7.2.1 The currently assigned organic peroxides specifically listed in packing instruction IBC520 may be transported in IBCs in accordance with this packing instruction. IBCs shall conform to the requirements of chapter 6.5 and shall meet its test provisions for packing group II.

4.1.7.2.2 Other organic peroxides and self-reactive substances of type F may be transported in IBCs under conditions established by the competent authority of the country of origin when, on the basis of the appropriate tests, that competent authority is satisfied that such transport may be safely conducted. The tests undertaken shall include those necessary:

- .1 to prove that the organic peroxide (or self-reactive substance) complies with the principles for classification;
- .2 to prove the compatibility of all materials normally in contact with the substance during the transport;
- .3 to determine, when applicable, the control and emergency temperatures associated with the transport of the product in the IBC concerned as derived from the SADT;
- .4 to design, when applicable, pressure and emergency relief devices; and
- .5 to determine if any special provisions are necessary for safe transport of the substance.

4.1.7.2.3 For self-reactive substances, temperature control is required according to 2.4.2.3.4. For organic peroxides, temperature control is required according to 2.5.3.4.1. Temperature control provisions are given in 7.3.7.

4.1.7.2.4 Emergencies to be taken into account are self-accelerating decomposition and fire engulfment. To prevent explosive rupture of metal or composite IBCs with a complete metal casing, the emergency relief devices shall be designed to vent all the decomposition products and vapours evolved during self-accelerating decomposition or during a period of not less than one hour of complete fire engulfment calculated by the equations given in 4.2.1.13.8.

## 4.1.8 Special packing provisions for infectious substances of category A (class 6.2, UN 2814 and UN 2900)

4.1.8.1 Consignors of infectious substances shall ensure that packages are prepared in such a manner that they arrive at their destination in good condition and present no hazard to persons or animals during transport.

4.1.8.2 The definitions in 1.2.1 and the general packing provisions of 4.1.1.1 to 4.1.1.14, except 4.1.1.10 to 4.1.1.12, apply to infectious substances packages. However, liquids shall only be filled into packagings which have an appropriate resistance to the internal pressure that may develop under normal conditions of transport.

4.1.8.3 An itemized list of contents shall be enclosed between the secondary packaging and the outer packaging. When the infectious substances to be transported are unknown, but suspected of meeting the criteria for inclusion in category A, the words "suspected category A infectious substance" shall be shown, in parentheses, following the Proper Shipping Name on the document inside the outer packaging.

4.1.8.4 Before an empty packaging is returned to the consignor, or sent elsewhere, it shall be disinfected or sterilized to nullify any hazard and any label or marking indicating that it had contained an infectious substance shall be removed or obliterated.

4.1.8.5 Provided an equivalent level of performance is maintained, the following variations in the primary receptacles placed within an intermediate packaging are allowed without further testing of the completed package:

- .1 Primary receptacles of equivalent or smaller size as compared to the tested primary receptacles may be used provided:
  - (a) the primary receptacles are of similar design to the tested primary receptacle (such as shape: round, rectangular, etc.);
  - (b) the material of construction of the primary receptacle (glass, plastics, metal, etc.) offers resistance to impact and stacking forces equal to or greater than that of the originally tested primary receptacle;
  - (c) the primary receptacles have the same or smaller openings and the closure is of similar design (such as screw cap, friction lid, etc.);
  - (d) sufficient additional cushioning material is used to take up void spaces and to prevent significant movement of the primary receptacles; and
  - (e) primary receptacles are oriented within the intermediate packaging in the same manner as in the tested package.



- .2 A lesser number of the tested primary receptacles, or of the alternative types of primary receptacles identified in .1 above, may be used provided sufficient cushioning is added to fill the void space(s) and to prevent significant movement of the primary receptacles.

## **4.1.9 Special packing provisions for class 7**

### **4.1.9.1 General**

- 4.1.9.1.1** Radioactive material, packagings and packages shall meet the provisions of chapter 6.4. The quantity of radioactive material in a package shall not exceed the limits specified in 2.7.2.2, 2.7.2.4.1, 2.7.2.4.4, 2.7.2.4.5, 2.7.2.4.6 and 4.1.9.3.

The types of packages for radioactive materials covered by the provisions of this Code are:

- .1 Excepted package (see 1.5.1.5);
- .2 Industrial package Type 1 (Type IP-1 package);
- .3 Industrial package Type 2 (Type IP-2 package);
- .4 Industrial package Type 3 (Type IP-3 package);
- .5 Type A package;
- .6 Type B(U) package;
- .7 Type B(M) package;
- .8 Type C package.

Packages containing fissile material or uranium hexafluoride are subject to additional requirements.

- 4.1.9.1.2** The non-fixed contamination on the external surfaces of any package shall be kept as low as practicable and, under routine conditions of transport, shall not exceed the following limits:

- (a) 4 Bq/cm<sup>2</sup> for beta and gamma emitters and low-toxicity alpha emitters, and
- (b) 0.4 Bq/cm<sup>2</sup> for all other alpha emitters.

These limits are applicable when averaged over any area of 300 cm<sup>2</sup> of any part of the surface.

- 4.1.9.1.3** A package, other than an excepted package, shall not contain any items other than those that are necessary for the use of the radioactive material. The interaction between these items and the package under the conditions of transport applicable to the design shall not reduce the safety of the package.

- 4.1.9.1.4** Except as provided in 7.1.4.5.11, the level of non-fixed contamination on the external and internal surfaces of overpacks, cargo transport units, tanks, IBCs and conveyances shall not exceed the limits specified in 4.1.9.1.2.

- 4.1.9.1.5** For radioactive material having other dangerous properties the package design shall take into account those properties. Radioactive material with a subsidiary risk, packaged in packages that do not require competent authority approval, shall be transported in packagings, IBCs, tanks or bulk containers fully complying with the provisions of the relevant chapters of part 6 as appropriate, as well as applicable provisions of chapters 4.1, 4.2 or 4.3 for that subsidiary risk.

- 4.1.9.1.6** Before the first shipment of any package, the following provisions shall be fulfilled:

- .1 If the design pressure of the containment system exceeds 35 kPa (gauge), it shall be ensured that the containment system of each package conforms to the approved design requirements relating to the capability of that system to maintain its integrity under that pressure;
- .2 For each Type B(U), Type B(M) and Type C package and for each package containing fissile material, it shall be ensured that the effectiveness of its shielding and containment and, where necessary, the heat transfer characteristics and the effectiveness of the confinement system are within the limits applicable to or specified for the approved design;
- .3 For packages containing fissile material, where, in order to comply with the requirements of 6.4.11.1, neutron poisons are specifically included as components of the package, checks shall be performed to confirm the presence and distribution of those neutron poisons.

- 4.1.9.1.7** Before each shipment of any package, the following provisions shall be fulfilled:

- .1 For any package, it shall be ensured that all provisions specified in the relevant provisions of this Code have been satisfied;
- .2 It shall be ensured that lifting attachments which do not meet the requirements of 6.4.2.2 have been removed or otherwise rendered incapable of being used for lifting the package, in accordance with 6.4.2.3;
- .3 For each package requiring competent authority approval, it shall be ensured that all the requirements specified in the approval certificates have been satisfied;

## Part 4 – Packing and tank provisions

- .4 Each Type B(U), Type B(M) and Type C package shall be held until equilibrium conditions have been approached closely enough to demonstrate compliance with the requirements for temperature and pressure unless an exemption from these requirements has received unilateral approval;
  - .5 For each Type B(U), Type B(M) and Type C package, it shall be ensured by inspection and/or appropriate tests that all closures, valves, and other openings of the containment system through which the radioactive contents might escape are properly closed and, where appropriate, sealed in the manner for which the demonstrations of compliance with the requirements of 6.4.8.8 and 6.4.10.3 were made;
  - .6 For each special form radioactive material, it shall be ensured that all the provisions specified in the approval certificate and the relevant provisions of this Code have been satisfied;
  - .7 For packages containing fissile material, the measurement specified in 6.4.11.4(b) and the tests to demonstrate closure of each package as specified in 6.4.11.7 shall be performed where applicable;
  - .8 For each low dispersible radioactive material, it shall be ensured that all the requirements specified in the approval certificate and the relevant provisions of this Code have been satisfied.
- 4.1.9.1.8 The consignor shall also have a copy of any instructions with regard to the proper closing of the package and any preparation for shipment before making any shipment under the terms of the certificates.
- 4.1.9.1.9 Except for consignments under exclusive use, the transport index of any package or overpack shall not exceed 10, nor shall the criticality safety index of any package or overpack exceed 50.
- 4.1.9.1.10 Except for packages or overpacks transported under exclusive use by rail or by road under the conditions specified in 7.1.4.5.5.1, or under exclusive use and special arrangement by ship under the conditions specified in 7.1.4.5.7, the maximum radiation level at any point on any external surface of a package or overpack shall not exceed 2 mSv/h.
- 4.1.9.1.11 The maximum radiation level at any point on any external surface of a package or overpack under exclusive use shall not exceed 10 mSv/h.
- 4.1.9.1.12 Pyrophoric radioactive material shall be packaged in Type A, Type B(U), Type B(M) or Type C packages and shall also be suitably inerted.
- 4.1.9.2 Provisions and controls for transport of LSA material and SCO**
- 4.1.9.2.1 The quantity of LSA material or SCO in a single Type IP-1 package, Type IP-2 package, Type IP-3 package, or object or collection of objects, whichever is appropriate, shall be so restricted that the external radiation level at 3 m from the unshielded material or object or collection of objects does not exceed 10 mSv/h.
- 4.1.9.2.2 For LSA material and SCO which is or contains fissile material, the applicable provisions of 6.4.11.1, 7.1.4.5.15 and 7.1.4.5.16 shall be met.
- 4.1.9.2.3 LSA material and SCO in groups LSA-I and SCO-I may be transported unpackaged under the following conditions:
- .1 all unpackaged material other than ores containing only naturally occurring radionuclides shall be transported in such a manner that, under routine conditions of transport, there will be no escape of the radioactive contents from the conveyance nor will there be any loss of shielding;
  - .2 each conveyance shall be under exclusive use, except when only transporting SCO-I on which the contamination on the accessible and the inaccessible surfaces is not greater than ten times the applicable level specified in 2.7.1.2; and
  - .3 for SCO-I where it is suspected that non-fixed contamination exists on inaccessible surfaces in excess of the values specified in 2.7.2.3.2.1(i), measures shall be taken to ensure that the radioactive material is not released into the conveyance.
- 4.1.9.2.4 LSA material and SCO, except as otherwise specified in 4.1.9.2.3, shall be packaged in accordance with table 4.1.9.2.4.

Table 4.1.9.2.4 – Industrial package provisions for LSA material and SCO

Radioactive contents	Industrial package type	
	Exclusive use	Not under exclusive use
LSA-I		
Solid <sup>a</sup>	Type IP-1	Type IP-1
Liquid	Type IP-1	Type IP-2
LSA-II		
Solid	Type IP-2	Type IP-2
Liquid and gas	Type IP-2	Type IP-3
LSA-III	Type IP-2	Type IP-3
SCO-I <sup>a</sup>	Type IP-1	Type IP-1
SCO-II	Type IP-2	Type IP-2

<sup>a</sup> Under the conditions specified in 4.1.9.2.3, LSA-I material and SCO-I may be transported unpackaged.

#### 4.1.9.3 Packages containing fissile material

Unless not classified as fissile in accordance with 2.7.2.3.5, packages containing fissile material shall not contain:

- .1 A mass of fissile material (or mass of each fissile nuclide for mixtures when appropriate) different from that authorized for the package design;
- .2 Any radionuclide or fissile material different from those authorized for the package design; or
- .3 Contents in a form or physical or chemical state, or in a spatial arrangement, different from those authorized for the package design,

as specified in their certificates of approval where appropriate.

## Chapter 4.2

---

### *Use of portable tanks and multiple-element gas containers (MEGCs)*

The provisions of this chapter also apply to road tank vehicles to the extent indicated in chapter 6.8.

#### 4.2.0 Transitional provisions

4.2.0.1 The provisions for the use and construction of portable tanks in this chapter and chapter 6.7 are based on the United Nations Recommendations on the transport of dangerous goods. IMO type portable tanks and road tank vehicles certified and approved prior to 1 January 2003 in accordance with the provisions of the IMDG Code in force on 1 July 1999 (amendment 29) may continue to be used provided that they are found to meet the applicable periodic inspections and test provisions. They shall meet the provisions set out in columns (13) and (14) of chapter 3.2. Detailed explanation and construction provisions may be found in DSC/Circ.12 (Guidance on the continued use of existing IMO type portable tanks and road tank vehicles for the transport of dangerous goods).

**Note:** For ease of reference, the following descriptions of existing IMO type tanks are included:

*IMO type 1 tank* means a portable tank for the transport of substances of classes 3 to 9 fitted with pressure-relief devices, having a maximum allowable working pressure of 1.75 bar and above.

*IMO type 2 tank* means a portable tank fitted with pressure-relief devices, having a maximum allowable working pressure equal to or above 1.0 bar but below 1.75 bar, intended for the transport of certain dangerous liquids of low hazard and certain solids.

*IMO type 4 tank* means a road tank vehicle for the transport of dangerous goods of classes 3 to 9 and includes a semi-trailer with a permanently attached tank or a tank attached to a chassis, with at least four twist locks which comply with ISO standards, (e.g. ISO International Standard 1161:1984).

*IMO type 5 tank* means a portable tank fitted with pressure-relief devices which is used for non-refrigerated gases of class 2.

*IMO type 6 tank* means a road tank vehicle for the transport of non-refrigerated liquefied gases of class 2 and includes a semi-trailer with a permanently attached tank or a tank attached to a chassis which is fitted with items of service equipment and structural equipment necessary for the transport of gases.

*IMO type 7 tank* means a thermally insulated portable tank fitted with items of service and structural equipment necessary for the transport of refrigerated liquefied gases. The portable tank shall be capable of being transported, loaded and discharged without the need of removal of its structural equipment, and shall be capable of being lifted when full. It shall not be permanently secured on board the ship.

*IMO type 8 tank* means a road tank vehicle for the transport of refrigerated liquefied gases of class 2 and includes a semi-trailer with a permanently attached thermally insulated tank fitted with items of service equipment and structural equipment necessary for the transport of refrigerated liquefied gases.

**Note:** IMO type 4, 6 and 8 road tank vehicles may be constructed after 1 January 2003 in accordance with the provisions of chapter 6.8.

4.2.0.2 UN portable tanks and MEGCs constructed according to a design approval certificate which has been issued before 1 January 2008 may continue to be used provided that they are found to meet the applicable periodic inspection and test provisions.

4.2.0.3 Portable tanks and MEGCs manufactured before 1 January 2012, that conform to the marking provisions of 6.7.2.20.1, 6.7.3.16.1, 6.7.4.15.1 or 6.7.5.13.1 of the IMDG Code in force on 1 January 2010 (amendment 34-08), as relevant, may continue to be used if they comply with all other relevant provisions of the current edition of the Code including, when applicable, the requirement of 6.7.2.20.1 (g) for marking the symbol "S" on the plate when the shell or the compartment is divided by surge plates into sections of not more than 7500 litres capacity. When the shell, or the compartment, was already divided by surge plates into sections of not more than 7500 litres capacity before 1 January 2012, the capacity of the shell, or respectively of the compartment, need not be supplemented with the symbol "S" until the next periodic inspection or test according to 6.7.2.19.5 is performed.

Portable tanks manufactured before 1 January 2014 need not be marked with the portable tank instruction as required in 6.7.2.20.2, 6.7.3.16.2 and 6.7.4.15.2 until the next periodic inspection and test.

Portable tanks and MEGCs manufactured before 1 January 2014 need not comply with the requirements of 6.7.2.13.1.6, 6.7.3.9.1.5, 6.7.4.8.1.5 and 6.7.5.6.1 (d) concerning the marking of the pressure relief devices.

#### 4.2.1 General provisions for the use of portable tanks for the transport of substances of class 1 and classes 3 to 9

4.2.1.1 This section provides general provisions applicable to the use of portable tanks for the transport of substances of classes 1, 3, 4, 5, 6, 7, 8 and 9. In addition to these general provisions, portable tanks shall conform to the design, construction, inspection and testing provisions detailed in 6.7.2. Substances shall be transported in portable tanks conforming to the applicable portable tank instruction and the portable tank special provisions assigned to each substance in the Dangerous Goods List.

4.2.1.2 During transport, portable tanks shall be adequately protected against damage to the shell and service equipment resulting from lateral and longitudinal impact and overturning. If the shell and service equipment are so constructed as to withstand impact or overturning, it need not be protected in this way. Examples of such protection are given in 6.7.2.17.5.

4.2.1.3 Certain substances are chemically unstable. They are accepted for transport only when the necessary steps have been taken to prevent their dangerous decomposition, transformation or polymerization during transport. To this end, care shall in particular be taken to ensure that shells do not contain any substances liable to promote these reactions.

4.2.1.4 The temperature of the outer surface of the shell, excluding openings and their closures, or of the thermal insulation shall not exceed 70°C during transport. When necessary, the shell shall be thermally insulated.

4.2.1.5 Empty portable tanks not cleaned and not gas-free shall comply with the same provisions as portable tanks filled with the previous substance.

4.2.1.6 Substances shall not be transported in adjoining compartments of shells when they may react dangerously with each other and cause:

- .1 combustion and/or evolution of considerable heat;
- .2 evolution of flammable, toxic or asphyxiant gases;
- .3 the formation of corrosive substances;
- .4 the formation of unstable substances;
- .5 dangerous rise in pressure.

4.2.1.7 The design approval certificate, the test report and the certificate showing the results of the initial inspection and test for each portable tank issued by the competent authority or its authorized body shall be retained by the authority or body and the owner. Owners shall be able to provide this documentation upon the request of any competent authority.

4.2.1.8 Unless the name of the substance(s) being transported appears on the metal plate described in 6.7.2.20.2, a copy of the certificate specified in 6.7.2.18.1 shall be made available upon the request of a competent authority or its authorized body and readily provided by the consignor, consignee or agent, as appropriate.

##### 4.2.1.9 Degree of filling

4.2.1.9.1 Prior to filling, the shipper shall ensure that the appropriate portable tank is used and that the portable tank is not loaded with substances which, in contact with the materials of the shell, gaskets, service equipment and any protective linings, are likely to react dangerously with them to form dangerous products or appreciably weaken these materials. The shipper may need to consult the manufacturer of the substance in conjunction with the competent authority for guidance on the compatibility of the substance with the portable tank materials.

4.2.1.9.1.1 Portable tanks shall not be filled in excess of the maximum degree of filling specified in 4.2.1.9.2 to 4.2.1.9.6. The applicability of 4.2.1.9.2, 4.2.1.9.3 or 4.2.1.9.5.1 to individual substances is specified in the applicable portable tank instructions or special provisions in 4.2.5.2.6 or 4.2.5.3 and columns 13 and 14 of the Dangerous Goods List.

4.2.1.9.2 The maximum degree of filling (in %) for general use is determined by the formula:

$$\text{Degree of filling} = \frac{97}{1 + \alpha(t_r - t_i)}$$

4.2.1.9.3 The maximum degree of filling (in %) for liquids of class 6.1 and class 8, in packing groups I and II, and liquids with an absolute vapour pressure of more than 175 kPa (1.75 bar) at 65°C, or for liquids identified as marine pollutants is determined by the formula:

$$\text{Degree of filling} = \frac{95}{1 + \alpha(t_r - t_i)}$$

Part 4 – Packing and tank provisions

4.2.1.9.4 In these formulae,  $\alpha$  is the mean coefficient of cubical expansion of the liquid between the mean temperature of the liquid during filling ( $t_f$ ) and the maximum mean bulk temperature during transport ( $t_r$ ) (both in °C). For liquids transported under ambient conditions,  $\alpha$  could be calculated by the formula:

$$\alpha = \frac{d_{15} - d_{50}}{35 d_{50}}$$

in which  $d_{15}$  and  $d_{50}$  are the densities of the liquid at 15°C and 50°C, respectively.

4.2.1.9.4.1 The maximum mean bulk temperature ( $t_r$ ) shall be taken as 50°C except that, for journeys under temperate or extreme climatic conditions, the competent authorities concerned may agree to a lower or require a higher temperature, as appropriate.

4.2.1.9.5 The provisions of 4.2.1.9.2 to 4.2.1.9.4.1 do not apply to portable tanks which contain substances maintained at a temperature above 50°C during transport (such as by means of a heating device). For portable tanks equipped with a heating device, a temperature regulator shall be used to ensure the maximum degree of filling is not more than 95% full at any time during transport.

4.2.1.9.5.1 The maximum degree of filling (in %) for solids transported above their melting points and for elevated temperature liquids shall be determined by the following formula:

$$\text{Degree of filling} = 95 \frac{d_f}{d_r}$$

in which  $d_f$  and  $d_r$  are the densities of the liquid at the mean temperature of the liquid during filling and the maximum mean bulk temperature during transport respectively.

4.2.1.9.6 Portable tanks shall not be offered for transport:

- .1 with a degree of filling, for liquids having a viscosity less than 2,680 mm<sup>2</sup>/s at 20°C or at the maximum temperature of the substance during transport in the case of a heated substance, of more than 20% but less than 80% unless the shells of portable tanks are divided, by partitions or surge plates, into sections of not more than 7,500 l capacity;
- .2 with residue of substances previously transported adhering to the outside of the shell or service equipment;
- .3 when leaking or damaged to such an extent that the integrity of the portable tank or its lifting or securing arrangements may be affected; and
- .4 unless the service equipment has been examined and found to be in good working order.

For certain dangerous substances, a lower degree of filling may be required.

4.2.1.9.7 Forklift pockets of portable tanks shall be closed off where the tank is filled. This provision does not apply to portable tanks which, according to 6.7.2.17.4, need not be provided with a means of closing off the forklift pockets.

4.2.1.9.8 Portable tanks shall not be filled or discharged while they remain on board.

4.2.1.10 Additional provisions applicable to the transport of class 3 substances in portable tanks

All portable tanks intended for the transport of flammable liquids shall be closed and be fitted with relief devices in accordance with 6.7.2.8 to 6.7.2.15.

4.2.1.11 Additional provisions applicable to the transport of class 4 substances (other than class 4.1 self-reactive substances) in portable tanks

[Reserved]

**Note:** For class 4.1 self-reactive substances, see 4.2.1.13.

4.2.1.12 Additional provisions applicable to the transport of class 5.1 substances in portable tanks

[Reserved]

4.2.1.13 Additional provisions applicable to the transport of class 5.2 substances and class 4.1 self-reactive substances in portable tanks

4.2.1.13.1 Each substance shall have been tested and a report submitted to the competent authority of the country of origin for approval. Notification thereof shall be sent to the competent authority of the country of destination. The notification shall contain relevant transport information and the report with test results. The tests undertaken shall include those necessary:

- .1 to prove the compatibility of all materials normally in contact with the substance during transport;

.2 to provide data for the design of the pressure and emergency relief devices, taking into account the design characteristics of the portable tank.

Any additional provisions necessary for safe transport of the substance shall be clearly described in the report.

- 4.2.1.13.2 The following provisions apply to portable tanks intended for the transport of type F organic peroxides or type F self-reactive substances with a self-accelerating decomposition temperature (SADT) of 55°C or more. In case of conflict, these provisions prevail over those specified in 6.7.2. Emergencies to be taken into account are self-accelerating decomposition of the substance and fire-engulfment as described in 4.2.1.13.8.
- 4.2.1.13.3 The additional provisions for transport of organic peroxides or self-reactive substances with an SADT less than 55°C in portable tanks shall be specified by the competent authority of the country of origin. Notification thereof shall be sent to the competent authority of the country of destination.
- 4.2.1.13.4 The portable tank shall be designed for a test pressure of at least 0.4 MPa (4 bar).
- 4.2.1.13.5 Portable tanks shall be fitted with temperature-sensing devices.
- 4.2.1.13.6 Portable tanks shall be fitted with pressure-relief devices and emergency relief devices. Vacuum-relief devices may also be used. Pressure-relief devices shall operate at pressures determined according to both the properties of the substance and the construction characteristics of the portable tank. Fusible elements are not allowed in the shell.
- 4.2.1.13.7 The pressure-relief devices shall consist of spring-loaded valves fitted to prevent significant build-up within the portable tank of the decomposition products and vapours released at a temperature of 50°C. The capacity and start-to-discharge pressure of the relief valves shall be based on the results of the tests specified in 4.2.1.13.1. The start-to-discharge pressure shall, however, in no case be such that liquid would escape from the valve(s) if the portable tank were overturned.
- 4.2.1.13.8 The emergency relief devices may be of the spring-loaded or frangible types, or a combination of the two, designed to vent all the decomposition products and vapours evolved during a period of not less than one hour of complete fire-engulfment as calculated by the following formula:

$$q = 70961FA^{0.82}$$

where:

- $q$  = heat absorption (W)  
 $A$  = wetted area (m<sup>2</sup>)  
 $F$  = insulation factor;

$F = 1$  for non-insulated vessels, or

$$F = \frac{U(923 - T)}{47032} \text{ for insulated shells}$$

where:

- $K$  = heat conductivity of insulation layer (W·m<sup>-1</sup>·K<sup>-1</sup>)  
 $L$  = thickness of insulation layer (m)  
 $U$  =  $K/L$  = heat transfer coefficient of the insulation (W·m<sup>-2</sup>·K<sup>-1</sup>)  
 $T$  = temperature of substance at relieving conditions (K)

The start-to-discharge pressure of the emergency relief device(s) shall be higher than that specified in 4.2.1.13.7 and based on the results of the tests referred to in 4.2.1.13.1. The emergency relief devices shall be dimensioned in such a way that the maximum pressure in the tank never exceeds the test pressure of the portable tank.

**Note:** An example of a method to determine the size of emergency relief devices is given in Appendix 5 of the *Manual of Tests and Criteria*.

- 4.2.1.13.9 For insulated portable tanks, the capacity and setting of emergency relief device(s) shall be determined assuming a loss of insulation from 1% of the surface area.
- 4.2.1.13.10 Vacuum-relief devices and spring-loaded valves shall be provided with flame arresters. Due attention shall be paid to the reduction of the relief capacity caused by the flame arrester.
- 4.2.1.13.11 Service equipment such as valves and external piping shall be so arranged that no substance remains in them after filling the portable tank.
- 4.2.1.13.12 Portable tanks may be either insulated or protected by a sunshield. If the SADT of the substance in the portable tank is 55°C or less, or the portable tank is constructed of aluminium, the portable tank shall be completely insulated. The outer surface shall be finished in white or bright metal.

## Part 4 – Packing and tank provisions

- 4.2.1.13.13 The degree of filling shall not exceed 90% at 15°C.
- 4.2.1.13.14 The marking as required in 6.7.2.20.2 shall include the UN Number and the technical name with the approved concentration of the substance concerned.
- 4.2.1.13.15 Organic peroxides and self-reactive substances specifically listed in portable tank instruction T23 in 4.2.5.2.6 may be transported in portable tanks.
- 4.2.1.14 **Additional provisions applicable to the transport of class 6.1 substances in portable tanks**  
[Reserved]
- 4.2.1.15 **Additional provisions applicable to the transport of class 6.2 substances in portable tanks**  
[Reserved]
- 4.2.1.16 **Additional provisions applicable to the transport of class 7 substances in portable tanks**
- 4.2.1.16.1 Portable tanks used for the transport of radioactive material shall not be used for the transport of other goods.
- 4.2.1.16.2 The degree of filling for portable tanks shall not exceed 90% or, alternatively, any other value approved by the competent authority.
- 4.2.1.17 **Additional provisions applicable to the transport of class 8 substances in portable tanks**
- 4.2.1.17.1 Pressure-relief devices of portable tanks used for the transport of class 8 substances shall be inspected at intervals not exceeding one year.
- 4.2.1.18 **Additional provisions applicable to the transport of class 9 substances in portable tanks**  
[Reserved]
- 4.2.1.19 **Additional provisions applicable to the transport of solid substances transported above their melting point**
- 4.2.1.19.1 Solid substances transported or offered for transport above their melting point which are not assigned a portable tank instruction in column 13 of the Dangerous Goods List of chapter 3.2 or when the assigned portable tank instruction does not apply to transport at temperatures above their melting point may be transported in portable tanks provided that the solid substances are classified in classes 4.1, 4.2, 4.3, 5.1, 6.1, 8 or 9 and have no subsidiary risk other than that of class 6.1 or class 8 and are in packing group II or III.
- 4.2.1.19.2 Unless otherwise indicated in the Dangerous Goods List, portable tanks used for the transport of these solid substances above their melting point shall conform to the provisions of portable tank instruction T4 for solid substances of packing group III or T7 for solid substances of packing group II. A portable tank that affords an equivalent or greater level of safety may be selected in accordance with 4.2.5.2.5. The maximum degree of filling (in %) shall be determined according to 4.2.1.9.5 (TP3).
- 4.2.2 **General provisions for the use of portable tanks for the transport of non-refrigerated liquefied gases and chemicals under pressure**
- 4.2.2.1 This section provides general provisions applicable to the use of portable tanks for the transport of non-refrigerated liquefied gases of class 2 and chemicals under pressure.
- 4.2.2.2 Portable tanks shall conform to the design, construction, inspection and testing provisions detailed in 6.7.3. Non-refrigerated liquefied gases and chemicals under pressure shall be transported in portable tanks conforming to portable tank instruction T50 as described in 4.2.5.2.6 and any portable tank special provisions assigned to specific non-refrigerated liquefied gases in the Dangerous Goods List and described in 4.2.5.3.
- 4.2.2.3 During transport, portable tanks shall be adequately protected against damage to the shell and service equipment resulting from lateral and longitudinal impact and overturning. If the shell and service equipment are so constructed as to withstand impact or overturning, it need not be protected in this way. Examples of such protection are given in 6.7.3.13.5.
- 4.2.2.4 Certain non-refrigerated liquefied gases are chemically unstable. They are accepted for transport only when the necessary steps have been taken to prevent their dangerous decomposition, transformation or polymerization during transport. To this end, care shall be taken to ensure that portable tanks do not contain any non-refrigerated liquefied gases liable to promote these reactions.



- 4.2.2.5 Unless the name of the gas(es) being transported appears on the metal plate described in 6.7.3.16.2, a copy of the certificate specified in 6.7.3.14.1 shall be made available upon a competent authority request and readily provided by the consignor, consignee or agent, as appropriate.
- 4.2.2.6 Empty portable tanks not cleaned and not gas-free shall comply with the same provisions as portable tanks filled with the previous non-refrigerated liquefied gas.
- 4.2.2.7 **Filling**
- 4.2.2.7.1 Prior to filling, the shipper shall ensure that the portable tank is approved for the non-refrigerated liquefied gas or the propellant of the chemical under pressure to be transported and that the portable tank is not loaded with non-refrigerated liquefied gases, or with chemicals under pressure which, in contact with the materials of the shell, gaskets and service equipment, are likely to react dangerously with them to form dangerous products or appreciably weaken these materials. During filling, the temperature of the non-refrigerated liquefied gas or propellant of chemicals under pressure shall fall within the limits of the design temperature range.
- 4.2.2.7.2 The maximum mass of non-refrigerated liquefied gas per litre of shell capacity (kg/l) shall not exceed the density of the non-refrigerated liquefied gas at 50°C multiplied by 0.95. Furthermore, the shell shall not be liquid-full at 60°C.
- 4.2.2.7.3 Portable tanks shall not be filled above their maximum permissible gross mass and the maximum permissible load mass specified for each gas to be transported.
- 4.2.2.7.4 Portable tanks shall not be filled or discharged while they remain on board.
- 4.2.2.8 Portable tanks shall not be offered for transport:
- .1 in an ullage condition liable to produce an unacceptable hydraulic force due to surge within the portable tank;
  - .2 when leaking;
  - .3 when damaged to such an extent that the integrity of the tank or its lifting or securing arrangements may be affected; and
  - .4 unless the service equipment has been examined and found to be in good working order.
- 4.2.2.9 Forklift pockets of portable tanks shall be closed off when the tank is filled. This provision does not apply to portable tanks which, according to 6.7.3.13.4, need not be provided with a means of closing off the forklift pockets.
- 4.2.3 **General provisions for the use of portable tanks for the transport of refrigerated liquefied gases of class 2**
- 4.2.3.1 This section provides general provisions applicable to the use of portable tanks for the transport of refrigerated liquefied gases.
- 4.2.3.2 Portable tanks shall conform to the design, construction, inspection and testing provisions detailed in 6.7.4. Refrigerated liquefied gases shall be transported in portable tanks conforming to portable tank instruction T75 as described in 4.2.5.2.6 and the portable tank special provisions assigned to each substance in columns 12 and 14 of the Dangerous Goods List and described in 4.2.5.3.
- 4.2.3.3 During transport, portable tanks shall be adequately protected against damage to the shell and service equipment resulting from lateral and longitudinal impact and overturning. If the shell and service equipment are so constructed as to withstand impact or overturning, it need not be protected in this way. Examples of such protection are provided in 6.7.4.12.5.
- 4.2.3.4 Unless the name of the gas(es) being transported appears on the metal plate described in 6.7.4.15.2, a copy of the certificate specified in 6.7.4.13.1 shall be made available upon a competent authority request and readily provided by the consignor, consignee or agent, as appropriate.
- 4.2.3.5 Empty portable tanks not cleaned and not gas-free shall comply with the same provisions as portable tanks filled with the previous substance.
- 4.2.3.6 **Filling**
- 4.2.3.6.1 Prior to filling, the shipper shall ensure that the portable tank is approved for the refrigerated liquefied gas to be transported and that the portable tank is not loaded with refrigerated liquefied gases which, in contact with the materials of the shell, gaskets and service equipment, are likely to react dangerously with them to form dangerous products or appreciably weaken these materials. During filling, the temperature of the refrigerated liquefied gas shall be within the limits of the design temperature range.

## Part 4 – Packing and tank provisions

- 4.2.3.6.2 In estimating the initial degree of filling, the necessary holding time for the intended journey, including any delays which might be encountered, shall be taken into consideration. The initial degree of filling of the shell, except as provided for in 4.2.3.6.3 and 4.2.3.6.4, shall be such that if the contents, except helium, were to be raised to a temperature at which the vapour pressure is equal to the maximum allowable working pressure (MAWP) the volume occupied by liquid would not exceed 98%.
- 4.2.3.6.3 Shells intended for the transport of helium can be filled up to but not above the inlet of the pressure-relief device.
- 4.2.3.6.4 A higher initial degree of filling may be allowed, subject to approval by the competent authority, when the intended duration of transport is considerably shorter than the holding time.
- 4.2.3.6.5 Portable tanks shall not be filled or discharged while they remain on board.
- 4.2.3.7 **Actual holding time**
- 4.2.3.7.1 The actual holding time shall be calculated for each journey in accordance with a procedure recognized by the competent authority, on the basis of the following:
- .1 the reference holding time for the refrigerated liquefied gas to be transported (see 6.7.4.2.8.1) (as indicated on the plate referred to in 6.7.4.15.1);
  - .2 the actual filling density;
  - .3 the actual filling pressure;
  - .4 the lowest set pressure of the pressure-limiting device(s).
- 4.2.3.7.2 The actual holding time shall be marked either on the portable tank itself or on a metal plate firmly secured to the portable tank, in accordance with 6.7.4.15.2.
- 4.2.3.8 Portable tanks shall not be offered for transport:
- .1 in an ullage condition liable to produce an unacceptable hydraulic force due to surge within the shell;
  - .2 when leaking;
  - .3 when damaged to such an extent that the integrity of the portable tank or its lifting or securing arrangements may be affected;
  - .4 unless the service equipment has been examined and found to be in good working order;
  - .5 unless the actual holding time for the refrigerated liquefied gas being transported has been determined in accordance with 4.2.3.7 and the portable tank is marked in accordance with 6.7.4.15.2; and
  - .6 unless the duration of transport, after taking into consideration any delays which might be encountered, does not exceed the actual holding time.
- 4.2.3.9 Forklift pockets of portable tanks shall be closed off when the tank is filled. This provision does not apply to portable tanks which, according to 6.7.4.12.4, need not be provided with a means of closing off the forklift pockets.
- 4.2.4 **General provisions for the use of multiple-element gas containers (MEGCs)**
- 4.2.4.1 This section provides general requirements applicable to the use of multiple-element gas containers (MEGCs) for the transport of non-refrigerated gases.
- 4.2.4.2 MEGCs shall conform to the design, construction, inspection and testing requirements detailed in 6.7.5. The elements of MEGCs shall be periodically inspected according to the provisions set out in packing instruction P200 and in 6.2.1.6.
- 4.2.4.3 During transport, MEGCs shall be protected against damage to the elements and service equipment resulting from lateral and longitudinal impact and overturning. If the elements and service equipment are so constructed as to withstand impact or overturning, they need not be protected in this way. Examples of such protection are given in 6.7.5.10.4.
- 4.2.4.4 The periodic testing and inspection requirements for MEGCs are specified in 6.7.5.12. MEGCs or their elements shall not be charged or filled after they become due for periodic inspection but may be transported after the expiry of the time limit.
- 4.2.4.5 **Filling**
- 4.2.4.5.1 Prior to filling, the MEGC shall be inspected to ensure that it is authorized for the gas to be transported and that the applicable provisions of this Code have been met.

- 4.2.4.5.2 Elements of MEGCs shall be filled according to the working pressures, filling ratios and filling provisions specified in packing instruction P200 for the specific gas being filled into each element. In no case shall an MEGC or group of elements be filled as a unit in excess of the lowest working pressure of any given element.
- 4.2.4.5.3 MEGCs shall not be filled above their maximum permissible gross mass.
- 4.2.4.5.4 Isolation valves shall be closed after filling and remain closed during transport. Toxic gases of class 2.3 shall only be transported in MEGCs where each element is equipped with an isolation valve.
- 4.2.4.5.5 The opening(s) for filling shall be closed by caps or plugs. The leakproofness of the closures and equipment shall be verified by the shipper after filling.
- 4.2.4.5.6 MEGCs shall not be offered for filling:
- .1 when damaged to such an extent that the integrity of the pressure receptacles or their structural or service equipment may be affected;
  - .2 unless the pressure receptacles and their structural and service equipment have been examined and found to be in good working order; and
  - .3 unless the required certification, retest, and filling markings are legible.
- 4.2.4.6 Filled MEGCs shall not be offered for transport;
- .1 when leaking;
  - .2 when damaged to such an extent that the integrity of the pressure receptacles or their structural or service equipment may be affected;
  - .3 unless the pressure receptacles and their structural and service equipment have been examined and found to be in good working order; and
  - .4 unless the required certification, retest, and filling markings are legible.
- 4.2.4.7 Empty MEGCs that have not been cleaned and purged shall comply with the same requirements as MEGCs filled with the previous substance.

## 4.2.5 Portable tank instructions and special provisions

### 4.2.5.1 General

- 4.2.5.1.1 This section includes the portable tank instructions and special provisions applicable to dangerous goods authorized to be transported in portable tanks. Each portable tank instruction is identified by an alpha-numeric designation (T1 to T75). The Dangerous Goods List in chapter 3.2 indicates the portable tank instruction that shall be used for each substance permitted for transport in a portable tank. When no portable tank instruction appears in the Dangerous Goods List, transport of the substance in portable tanks is not permitted unless a competent authority approval is granted as set out in 6.7.1.3. Portable tank special provisions are assigned to specific dangerous goods in the Dangerous Goods List in chapter 3.2. Each portable tank special provision is identified by an alpha-numeric designation (such as TP1). A listing of the portable tank special provisions is provided in 4.2.5.3.

**Note:** The gases authorized for transport in MEGCs are indicated in the column “MEGC” in Tables 1 and 2 of packing instruction P200 in 4.1.4.1.

### 4.2.5.2 Portable tank instructions

- 4.2.5.2.1 Portable tank instructions apply to dangerous goods of classes 1 to 9. Portable tank instructions provide specific information relevant to portable tank provisions applicable to specific substances. These provisions shall be met in addition to the general provisions in this chapter and chapter 6.7.
- 4.2.5.2.2 For substances of class 1 and classes 3 to 9, the portable tank instructions indicate the applicable minimum test pressure, the minimum shell thickness (in reference steel), bottom opening provisions and pressure-relief provisions. In T23, self-reactive substances of class 4.1 and class 5.2 organic peroxides permitted to be transported in portable tanks are listed along with applicable control and emergency temperatures.
- 4.2.5.2.3 Non-refrigerated liquefied gases are assigned to portable tank instruction T50. T50 provides the maximum allowable working pressures, bottom opening provisions, pressure-relief provisions and degree of filling provisions for non-refrigerated liquefied gases permitted for transport in portable tanks.
- 4.2.5.2.4 Refrigerated liquefied gases are assigned to portable tank instruction T75.

**Part 4 – Packing and tank provisions**

**4.2.5.2.5 Determination of the appropriate portable tank instructions**

When a specific portable tank instruction is specified in the Dangerous Goods List, additional portable tanks which possess higher test pressures, greater shell thicknesses, more stringent bottom opening and pressure-relief device arrangements may be used. The following guidelines apply to determining the appropriate portable tanks which may be used for transport of particular substances:

Portable tank instruction specified	Portable tank instructions also permitted
T1	T2, T3, T4, T5, T6, T7, T8, T9, T10, T11, T12, T13, T14, T15, T16, T17, T18, T19, T20, T21, T22
T2	T4, T5, T7, T8, T9, T10, T11, T12, T13, T14, T15, T16, T17, T18, T19, T20, T21, T22
T3	T4, T5, T6, T7, T8, T9, T10, T11, T12, T13, T14, T15, T16, T17, T18, T19, T20, T21, T22
T4	T5, T7, T8, T9, T10, T11, T12, T13, T14, T15, T16, T17, T18, T19, T20, T21, T22
T5	T10, T14, T19, T20, T22
T6	T7, T8, T9, T10, T11, T12, T13, T14, T15, T16, T17, T18, T19, T20, T21, T22
T7	T8, T9, T10, T11, T12, T13, T14, T15, T16, T17, T18, T19, T20, T21, T22
T8	T9, T10, T13, T14, T19, T20, T21, T22
T9	T10, T13, T14, T19, T20, T21, T22
T10	T14, T19, T20, T22
T11	T12, T13, T14, T15, T16, T17, T18, T19, T20, T21, T22
T12	T14, T16, T18, T19, T20, T22
T13	T14, T19, T20, T21, T22
T14	T19, T20, T22
T15	T16, T17, T18, T19, T20, T21, T22
T16	T18, T19, T20, T22
T17	T18, T19, T20, T21, T22
T18	T19, T20, T22
T19	T20, T22
T20	T22
T21	T22
T22	None
T23	None
T50	None

4.2.5.2.6 *Portable tank instructions*

Portable tank instructions specify the provisions applicable to a portable tank when used for the transport of specific substances. Portable tank instructions T1 to T22 specify the applicable minimum test pressure, the minimum shell thickness (in mm of reference steel), and the pressure relief and bottom-opening provisions.

T1 – T22		PORTABLE TANK INSTRUCTIONS			T1 – T22
These portable tank instructions apply to liquid and solid substances of classes 3 to 9. The general provisions of 6.7.2 shall be met.					
Portable tank instruction	Minimum test pressure (bar)	Minimum shell thickness (in mm – reference steel) (see 6.7.2.4)	Pressure relief provisions <sup>a</sup> (see 6.7.2.8)	Bottom opening provisions <sup>b</sup> (see 6.7.2.6)	
T1	1.5	See 6.7.2.4.2	Normal	See 6.7.2.6.2	
T2	1.5	See 6.7.2.4.2	Normal	See 6.7.2.6.3	
T3	2.65	See 6.7.2.4.2	Normal	See 6.7.2.6.2	
T4	2.65	See 6.7.2.4.2	Normal	See 6.7.2.6.3	
T5	2.65	See 6.7.2.4.2	See 6.7.2.8.3	Not allowed	
T6	4	See 6.7.2.4.2	Normal	See 6.7.2.6.2	
T7	4	See 6.7.2.4.2	Normal	See 6.7.2.6.3	
T8	4	See 6.7.2.4.2	Normal	Not allowed	
T9	4	6 mm	Normal	Not allowed	
T10	4	6 mm	See 6.7.2.8.3	Not allowed	
T11	6	See 6.7.2.4.2	Normal	See 6.7.2.6.3	
T12	6	See 6.7.2.4.2	See 6.7.2.8.3	See 6.7.2.6.3	
T13	6	6 mm	Normal	Not allowed	
T14	6	6 mm	See 6.7.2.8.3	Not allowed	
T15	10	See 6.7.2.4.2	Normal	See 6.7.2.6.3	
T16	10	See 6.7.2.4.2	See 6.7.2.8.3	See 6.7.2.6.3	
T17	10	6 mm	Normal	See 6.7.2.6.3	
T18	10	6 mm	See 6.7.2.8.3	See 6.7.2.6.3	
T19	10	6 mm	See 6.7.2.8.3	Not allowed	
T20	10	8 mm	See 6.7.2.8.3	Not allowed	
T21	10	10 mm	Normal	Not allowed	
T22	10	10 mm	See 6.7.2.8.3	Not allowed	

<sup>a</sup> When the word “Normal” is indicated, all the provisions of 6.7.2.8 apply except for 6.7.2.8.3.

<sup>b</sup> When this column indicates “not allowed”, bottom openings are not permitted when the substance to be transported is a liquid (see 6.7.2.6.1). When the substance to be transported is a solid at all temperatures encountered under normal conditions of transport, bottom openings conforming to the provisions of 6.7.2.6.2 are authorized.

## Part 4 – Packing and tank provisions

T23		PORTABLE TANK INSTRUCTION						T23	
This portable tank instruction applies to substances of class 4.1 and class 5.2, organic peroxides. The general provisions of 4.2.1 and the provisions of 6.7.2 shall be met. The provisions specific to self-reactive substances of class 4.1 and organic peroxides of class 5.2 in 4.2.1.13 shall also be met.									
UN No.	Substance	Minimum test pressure (bar)	Minimum shell thickness (mm – reference steel)	Bottom opening requirements	Pressure relief requirements	Degree of filling	Control temperature	Emergency temperature	
3109	<b>ORGANIC PEROXIDE TYPE F, LIQUID</b> <i>tert</i> -Butyl hydroperoxide,* not more than 72% with water Cumyl hydroperoxide, not more than 90% in diluent type A Di- <i>tert</i> -butyl peroxide, not more than 32% in diluent type A Isopropyl cumyl hydroperoxide, not more than 72% in diluent type A <i>p</i> -Menthyl hydroperoxide, not more than 72% in diluent type A Pinanyl hydroperoxide, not more than 56% in diluent type A	4	See 6.7.2.4.2	See 6.7.2.6.3	See 6.7.2.8.2, 4.2.1.13.6, 4.2.1.13.7, 4.2.1.13.8	See 4.2.1.13.13			
3110	<b>ORGANIC PEROXIDE TYPE F, SOLID</b> Dicumyl peroxide <sup>†</sup>	4	See 6.7.2.4.2	See 6.7.2.6.3	See 6.7.2.8.2, 4.2.1.13.6, 4.2.1.13.7, 4.2.1.13.8	See 4.2.1.13.13			
3119	<b>ORGANIC PEROXIDE TYPE F, LIQUID, TEMPERATURE CONTROLLED</b>  <i>tert</i> -Amyl peroxyneodecanoate, not more than 47% in diluent type A <i>tert</i> -Butyl peroxyacetate, not more than 32% in diluent type B <i>tert</i> -Butyl peroxy-2-ethyl-hexanoate, not more than 32% in diluent type B <i>tert</i> -Butyl peroxy-pivalate, not more than 27% in diluent type B <i>tert</i> -Butyl peroxy-3,5,5-trimethylhexanoate, not more than 32% in diluent type B Di-(3,5,5-trimethylhexanoyl) peroxide, not more than 38% in diluent type A or type B Peroxyacetic acid, distilled, stabilized <sup>§</sup>	4	See 6.7.2.4.2	See 6.7.2.6.3	See 6.7.2.8.2, 4.2.1.13.6, 4.2.1.13.7, 4.2.1.13.8	See 4.2.1.13.13	‡	‡	
3120	<b>ORGANIC PEROXIDE TYPE F, SOLID, TEMPERATURE CONTROLLED</b>	4	See 6.7.2.4.2	See 6.7.2.6.3	See 6.7.2.8.2, 4.2.1.13.6, 4.2.1.13.7, 4.2.1.13.8	See 4.2.1.13.13	‡	‡	

\* Provided that steps have been taken to achieve the safety equivalence of 65% *tert*-butyl hydroperoxide and 35% water.

<sup>†</sup> Maximum quantity per portable tank: 2000 kg.

<sup>‡</sup> As approved by the competent authority.

<sup>§</sup> Formulation derived from distillation of peroxyacetic acid originating from peroxyacetic acid in concentration of not more than 41% with water, total active oxygen (peroxyacetic acid + H<sub>2</sub>O<sub>2</sub>) ≤ 9.5%, which fulfils the criteria of 2.5.3.3.2.6.

T23 PORTABLE TANK INSTRUCTION (continued) T23								
UN No.	Substance	Minimum test pressure (bar)	Minimum shell thickness (mm – reference steel)	Bottom opening requirements	Pressure relief requirements	Degree of filling	Control temperature	Emergency temperature
3229	SELF-REACTIVE LIQUID TYPE F	4	See 6.7.2.4.2	See 6.7.2.6.3	See 6.7.2.8.2, 4.2.1.13.6, 4.2.1.13.7, 4.2.1.13.8	See 4.2.1.13.13		
3230	SELF-REACTIVE SOLID TYPE F	4	See 6.7.2.4.2	See 6.7.2.6.3	See 6.7.2.8.2, 4.2.1.13.6, 4.2.1.13.7, 4.2.1.13.8	See 4.2.1.13.13		
3239	SELF-REACTIVE LIQUID TYPE F, TEMPERATURE CONTROLLED	4	See 6.7.2.4.2	See 6.7.2.6.3	See 6.7.2.8.2, 4.2.1.13.6, 4.2.1.13.7, 4.2.1.13.8	See 4.2.1.13.13	*	*
3240	SELF-REACTIVE SOLID TYPE F, TEMPERATURE CONTROLLED	4	See 6.7.2.4.2	See 6.7.2.6.3	See 6.7.2.8.2, 4.2.1.13.6, 4.2.1.13.7, 4.2.1.13.8	See 4.2.1.13.13	*	*

\* As approved by the competent authority.

T50 PORTABLE TANK INSTRUCTION T50					
This portable tank instruction applies to non-refrigerated liquefied gases and chemicals under pressure (UN Nos. 3500, 3501, 3502, 3503, 3504 and 3505). The general provisions of 4.2.2 and the provisions of 6.7.3 shall be met.					
UN No.	Non-refrigerated liquefied gases	Maximum allowable working pressure (bar) Small; Bare; Sunshield; Insulated respectively <sup>a</sup>	Openings below liquid level	Pressure relief provisions <sup>b</sup> (see 6.7.3.7)	Maximum filling density (kg/l)
1005	Ammonia, anhydrous	29.0 25.7 22.0 19.7	Allowed	See 6.7.3.7.3	0.53
1009	Bromotrifluoromethane (Refrigerant gas R 13B1)	38.0 34.0 30.0 27.5	Allowed	Normal	1.13
1010	Butadienes, stabilized	7.5 7.0 7.0 7.0	Allowed	Normal	0.55
1010	Butadienes and hydrocarbon mixture, stabilized with more than 40% butadienes	See MAWP definition in 6.7.3.1	Allowed	Normal	See 4.2.2.7
1011	Butane	7.0 7.0 7.0 7.0	Allowed	Normal	0.51
1012	Butylene	8.0 7.0 7.0 7.0	Allowed	Normal	0.53

<sup>a</sup> "Small" means tanks having a shell with a diameter of 1.5 metres or less; "Bare" means tanks having a shell with a diameter of more than 1.5 metres without insulation or sun shield (see 6.7.3.2.12); "Sunshield" means tanks having a shell with a diameter of more than 1.5 metres with sun shield (see 6.7.3.2.12); "Insulated" means tanks having a shell with a diameter of more than 1.5 metres with insulation (see 6.7.3.2.12); (See definition of "Design reference temperature" in 6.7.3.1).

<sup>b</sup> The word "Normal" in the pressure relief column indicates that a frangible disc as specified in 6.7.3.7.3 is not required.

## Part 4 – Packing and tank provisions

T50		PORTABLE TANK INSTRUCTION (continued)				T50
UN No.	Non-refrigerated liquefied gases	Maximum allowable working pressure (bar) Small; Bare; Sunshield; Insulated respectively <sup>a</sup>	Openings below liquid level	Pressure relief provisions <sup>b</sup> (see 6.7.3.7)	Maximum filling density (kg/l)	
1017	Chlorine	19.0 17.0 15.0 13.5	Not allowed	See 6.7.3.7.3	1.25	
1018	Chlorodifluoromethane (Refrigerant gas R 22)	26.0 24.0 21.0 19.0	Allowed	Normal	1.03	
1020	Chloropentafluoroethane (Refrigerant gas R 115)	23.0 20.0 18.0 16.0	Allowed	Normal	1.06	
1021	1-Chloro-1,2,2,2-tetrafluoroethane (Refrigerant gas R 124)	10.3 9.8 7.9 7.0	Allowed	Normal	1.20	
1027	Cyclopropane	18.0 16.0 14.5 13.0	Allowed	Normal	0.53	
1028	Dichlorodifluoromethane (Refrigerant gas R 12)	16.0 15.0 13.0 11.5	Allowed	Normal	1.15	
1029	Dichlorofluoromethane (Refrigerant gas R 21)	7.0 7.0 7.0 7.0	Allowed	Normal	1.23	
1030	1,1-Difluoroethane (Refrigerant gas R 152a)	16.0 14.0 12.4 11.0	Allowed	Normal	0.79	
1032	Dimethylamine, anhydrous	7.0 7.0 7.0 7.0	Allowed	Normal	0.59	
1033	Dimethyl ether	15.5 13.8 12.0 10.6	Allowed	Normal	0.58	
1036	Ethylamine	7.0 7.0 7.0 7.0	Allowed	Normal	0.61	
1037	Ethyl chloride	7.0 7.0 7.0 7.0	Allowed	Normal	0.80	
1040	Ethylene oxide with nitrogen up to a total pressure of 1 MPa (10 bar) at 50°C	– – – 10.0	Not allowed	See 6.7.3.7.3	0.78	
1041	Ethylene oxide and carbon dioxide mixture with more than 9% but not more than 87% ethylene oxide	See MAWP definition in 6.7.3.1	Allowed	Normal	See 4.2.2.7	

<sup>a</sup> "Small" means tanks having a shell with a diameter of 1.5 metres or less; "Bare" means tanks having a shell with a diameter of more than 1.5 metres without insulation or sun shield (see 6.7.3.2.12); "Sunshield" means tanks having a shell with a diameter of more than 1.5 metres with sun shield (see 6.7.3.2.12); "Insulated" means tanks having a shell with a diameter of more than 1.5 metres with insulation (see 6.7.3.2.12); (See definition of "Design reference temperature" in 6.7.3.1).

<sup>b</sup> The word "Normal" in the pressure relief column indicates that a frangible disc as specified in 6.7.3.7.3 is not required.



T50		PORTABLE TANK INSTRUCTION (continued)			T50
UN No.	Non-refrigerated liquefied gases	Maximum allowable working pressure (bar) Small; Bare; Sunshield; Insulated respectively <sup>a</sup>	Openings below liquid level	Pressure relief provisions <sup>b</sup> (see 6.7.3.7)	Maximum filling density (kg/l)
1055	Isobutylene	8.1 7.0 7.0 7.0	Allowed	Normal	0.52
1060	Methylacetylene and propadiene mixture, stabilized	28.0 24.5 22.0 20.0	Allowed	Normal	0.43
1061	Methylamine, anhydrous	10.8 9.6 7.8 7.0	Allowed	Normal	0.58
1062	Methyl bromide with not more than 2% chloropicrin	7.0 7.0 7.0 7.0	Not allowed	See 6.7.3.7.3	1.51
1063	Methyl chloride (Refrigerant gas R40)	14.5 12.7 11.3 10.0	Allowed	Normal	0.81
1064	Methyl mercaptan	7.0 7.0 7.0 7.0	Not allowed	See 6.7.3.7.3	0.78
1067	Dinitrogen tetroxide	7.0 7.0 7.0 7.0	Not allowed	See 6.7.3.7.3	1.30
1075	Petroleum gas, liquefied	See MAWP definition in 6.7.3.1	Allowed	Normal	See 4.2.2.7
1077	Propylene	28.0 24.5 22.0 20.0	Allowed	Normal	0.43
1078	Refrigerant gas, N.O.S.	See MAWP definition in 6.7.3.1	Allowed	Normal	See 4.2.2.7
1079	Sulphur dioxide	11.6 10.3 8.5 7.6	Not allowed	See 6.7.3.7.3	1.23
1082	Trifluorochloroethylene, stabilized (Refrigerant gas R 1113)	17.0 15.0 13.1 11.6	Not allowed	See 6.7.3.7.3	1.13
1083	Trimethylamine, anhydrous	7.0 7.0 7.0 7.0	Allowed	Normal	0.56
1085	Vinyl bromide, stabilized	7.0 7.0 7.0 7.0	Allowed	Normal	1.37
1086	Vinyl chloride, stabilized	10.6 9.3 8.0 7.0	Allowed	Normal	0.81

<sup>a</sup> "Small" means tanks having a shell with a diameter of 1.5 metres or less; "Bare" means tanks having a shell with a diameter of more than 1.5 metres without insulation or sun shield (see 6.7.3.2.12); "Sunshield" means tanks having a shell with a diameter of more than 1.5 metres with sun shield (see 6.7.3.2.12); "Insulated" means tanks having a shell with a diameter of more than 1.5 metres with insulation (see 6.7.3.2.12); (See definition of "Design reference temperature" in 6.7.3.1).

<sup>b</sup> The word "Normal" in the pressure relief column indicates that a frangible disc as specified in 6.7.3.7.3 is not required.

## Part 4 – Packing and tank provisions

T50 PORTABLE TANK INSTRUCTION (continued) T50					
UN No.	Non-refrigerated liquefied gases	Maximum allowable working pressure (bar) Small; Bare; Sunshield; Insulated respectively <sup>a</sup>	Openings below liquid level	Pressure relief provisions <sup>b</sup> (see 6.7.3.7)	Maximum filling density (kg/l)
1087	Vinyl methyl ether, stabilized	7.0 7.0 7.0 7.0	Allowed	Normal	0.67
1581	Chloropicrin and methyl bromide mixture with more than 2% chloropicrin	7.0 7.0 7.0 7.0	Not allowed	See 6.7.3.7.3	1.51
1582	Chloropicrin and methyl chloride mixture	19.2 16.9 15.1 13.1	Not allowed	See 6.7.3.7.3	0.81
1858	Hexafluoropropylene (Refrigerant gas R 1216)	19.2 16.9 15.1 13.1	Allowed	Normal	1.11
1912	Methyl chloride and methylene chloride mixture	15.2 13.0 11.6 10.1	Allowed	Normal	0.81
1958	1,2-Dichloro-1,1,2,2-tetrafluoroethane (Refrigerant gas R 114)	7.0 7.0 7.0 7.0	Allowed	Normal	1.30
1965	Hydrocarbon gas, mixture liquefied, N.O.S.	See MAWP definition in 6.7.3.1	Allowed	Normal	See 4.2.2.7
1969	Isobutane	8.5 7.5 7.0 7.0	Allowed	Normal	0.49
1973	Chlorodifluoromethane and chloropentafluoroethane mixture with fixed boiling point, with approximately 49% chlorodifluoromethane (Refrigerant gas R 502)	28.3 25.3 22.8 20.3	Allowed	Normal	1.05
1974	Chlorodifluorobromomethane (Refrigerant gas R 12B1)	7.4 7.0 7.0 7.0	Allowed	Normal	1.61
1976	Octafluorocyclobutane (Refrigerant gas RC 318)	8.8 7.8 7.0 7.0	Allowed	Normal	1.34
1978	Propane	22.5 20.4 18.0 16.5	Allowed	Normal	0.42
1983	1-Chloro-2,2,2-trifluoroethane (Refrigerant gas R 133a)	7.0 7.0 7.0 7.0	Allowed	Normal	1.18
2035	1,1,1-Trifluoroethane (Refrigerant gas R 143a)	31.0 27.5 24.2 21.8	Allowed	Normal	0.76

<sup>a</sup> "Small" means tanks having a shell with a diameter of 1.5 metres or less; "Bare" means tanks having a shell with a diameter of more than 1.5 metres without insulation or sun shield (see 6.7.3.2.12); "Sunshield" means tanks having a shell with a diameter of more than 1.5 metres with sun shield (see 6.7.3.2.12); "Insulated" means tanks having a shell with a diameter of more than 1.5 metres with insulation (see 6.7.3.2.12); (See definition of "Design reference temperature" in 6.7.3.1).

<sup>b</sup> The word "Normal" in the pressure relief column indicates that a frangible disc as specified in 6.7.3.7.3 is not required.

PORTABLE TANK INSTRUCTION (continued)					
UN No.	Non-refrigerated liquefied gases	Maximum allowable working pressure (bar) Small; Bare; Sunshield; Insulated respectively <sup>a</sup>	Openings below liquid level	Pressure relief provisions <sup>b</sup> (see 6.7.3.7)	Maximum filling density (kg/l)
2424	Octafluoropropane (Refrigerant gas R 218)	23.1 20.8 18.6 16.6	Allowed	Normal	1.07
2517	1-Chloro-1,1-difluoroethane (Refrigerant gas R 142b)	8.9 7.8 7.0 7.0	Allowed	Normal	0.99
2602	Dichlorodifluoromethane and difluoroethane azeotropic mixture with approximately 74% dichlorodifluoromethane (Refrigerant gas R 500)	20.0 18.0 16.0 14.5	Allowed	Normal	1.01
3057	Trifluoroacetyl chloride	14.6 12.9 11.3 9.9	Not allowed	See 6.7.3.7.3	1.17
3070	Ethylene oxide and dichlorodifluoromethane mixture, with not more than 12.5% ethylene oxide	14.0 12.0 11.0 9.0	Allowed	See 6.7.3.7.3	1.09
3153	Perfluoro(methyl vinyl ether)	14.3 13.4 11.2 10.2	Allowed	Normal	1.14
3159	1,1,1,2-Tetrafluoroethane (Refrigerant gas R 134a)	17.7 15.7 13.8 12.1	Allowed	Normal	1.04
3161	Liquefied gas, flammable, N.O.S.	See MAWP definition in 6.7.3.1	Allowed	Normal	See 4.2.2.7
3163	Liquefied gas, N.O.S.	See MAWP definition in 6.7.3.1	Allowed	Normal	See 4.2.2.7
3220	Pentafluoroethane (Refrigerant gas R 125)	34.4 30.8 27.5 24.5	Allowed	Normal	0.87
3252	Difluoromethane (Refrigerant gas R 32)	43.0 39.0 34.4 30.5	Allowed	Normal	0.78
3296	Heptafluoropropane (Refrigerant gas R 227)	16.0 14.0 12.5 11.0	Allowed	Normal	1.20
3297	Ethylene oxide and chlorotetrafluoroethane mixture, with not more than 8.8% ethylene oxide	8.1 7.0 7.0 7.0	Allowed	Normal	1.16
3298	Ethylene oxide and pentafluoroethane mixture, with not more than 7.9% ethylene oxide	25.9 23.4 20.9 18.6	Allowed	Normal	1.02
3299	Ethylene oxide and tetrafluoroethane mixture, with not more than 5.6% ethylene oxide	16.7 14.7 12.9 11.2	Allowed	Normal	1.03

<sup>a</sup> "Small" means tanks having a shell with a diameter of 1.5 metres or less; "Bare" means tanks having a shell with a diameter of more than 1.5 metres without insulation or sun shield (see 6.7.3.2.12); "Sunshield" means tanks having a shell with a diameter of more than 1.5 metres with sun shield (see 6.7.3.2.12); "Insulated" means tanks having a shell with a diameter of more than 1.5 metres with insulation (see 6.7.3.2.12); (See definition of "Design reference temperature" in 6.7.3.1).

<sup>b</sup> The word "Normal" in the pressure relief column indicates that a frangible disc as specified in 6.7.3.7.3 is not required.

Part 4 – Packing and tank provisions

T50 PORTABLE TANK INSTRUCTION (continued) T50					
UN No.	Non-refrigerated liquefied gases	Maximum allowable working pressure (bar) Small; Bare; Sunshield; Insulated respectively <sup>a</sup>	Openings below liquid level	Pressure relief provisions <sup>b</sup> (see 6.7.3.7)	Maximum filling density (kg/l)
3318	Ammonia solution, relative density less than 0.880 at 15°C in water, with more than 50% ammonia	See MAWP definition in 6.7.3.1	Allowed	See 6.7.3.7.3	See 4.2.2.7
3337	Refrigerant gas R 404A	31.6 28.3 25.3 22.5	Allowed	Normal	0.82
3338	Refrigerant gas R 407A	31.3 28.1 25.1 22.4	Allowed	Normal	0.94
3339	Refrigerant gas R 407B	33.0 29.6 26.5 23.6	Allowed	Normal	0.93
3340	Refrigerant gas R 407C	29.9 26.8 23.9 21.3	Allowed	Normal	0.95
3500	Chemical under pressure, n.o.s.	See MAWP definition in 6.7.3.1	Allowed	See 6.7.3.7.3	TP4 <sup>c</sup>
3501	Chemical under pressure, flammable, n.o.s.	See MAWP definition in 6.7.3.1	Allowed	See 6.7.3.7.3	TP4 <sup>c</sup>
3502	Chemical under pressure, toxic, n.o.s.	See MAWP definition in 6.7.3.1	Allowed	See 6.7.3.7.3	TP4 <sup>c</sup>
3503	Chemical under pressure, corrosive, n.o.s.	See MAWP definition in 6.7.3.1	Allowed	See 6.7.3.7.3	TP4 <sup>c</sup>
3504	Chemical under pressure, flammable, toxic, n.o.s.	See MAWP definition in 6.7.3.1	Allowed	See 6.7.3.7.3	TP4 <sup>c</sup>
3505	Chemical under pressure, flammable, corrosive, n.o.s.	See MAWP definition in 6.7.3.1	Allowed	See 6.7.3.7.3	TP4 <sup>c</sup>

<sup>a</sup> “Small” means tanks having a shell with a diameter of 1.5 metres or less; “Bare” means tanks having a shell with a diameter of more than 1.5 metres without insulation or sun shield (see 6.7.3.2.12); “Sunshield” means tanks having a shell with a diameter of more than 1.5 metres with sun shield (see 6.7.3.2.12); “Insulated” means tanks having a shell with a diameter of more than 1.5 metres with insulation (see 6.7.3.2.12); (See definition of “Design reference temperature” in 6.7.3.1).

<sup>b</sup> The word “Normal” in the pressure relief column indicates that a frangible disc as specified in 6.7.3.7.3 is not required.

<sup>c</sup> For UN Nos. 3500, 3501, 3502, 3503, 3504 and 3505, the degree of filling shall be considered instead of the maximum filling ratio.

T75 PORTABLE TANK INSTRUCTION T75	
This portable tank instruction applies to refrigerated liquefied gases. The general provisions of 4.2.3 and 6.7.4 shall be met.	

4.2.5.3 Portable tank special provisions

Portable tank special provisions are assigned to certain substances to indicate provisions which are in addition to or in lieu of those provided by the portable tank instructions or the provisions in chapter 6.7. Portable tank special provisions are identified by an alpha-numeric designation beginning with the letters “TP” (tank provision) and are assigned to specific substances in column 14 of the Dangerous Goods List in chapter 3.2. The following is a list of the portable tank special provisions:

- TP1 The degree of filling prescribed in 4.2.1.9.2 shall not be exceeded.
- TP2 The degree of filling prescribed in 4.2.1.9.3 shall not be exceeded.
- TP3 The maximum degree of filling (in %) for solids transported above their melting points and for elevated temperature liquids shall be determined in accordance with 4.2.1.9.5.
- TP4 The degree of filling shall not exceed 90% or, alternatively, any other value approved by the competent authority (see 4.2.1.16.2).
- TP5 The degree of filling prescribed in 4.2.3.6 shall be met.

- TP6 To prevent the tank bursting in any event, including fire engulfment, it shall be provided with pressure-relief devices which are adequate in relation to the capacity of the tank and to the nature of the substance transported. The device shall also be compatible with the substance.
- TP7 Air shall be eliminated from the vapour space by nitrogen or other means.
- TP8 The test pressure for the portable tank may be reduced to 1.5 bar when the flashpoint of the substances transported is greater than 0°C.
- TP9 A substance under this description shall only be transported in a portable tank under an approval granted by the competent authority.
- TP10 A lead lining, not less than 5 mm thick, which shall be tested annually, or another suitable lining material approved by the competent authority is required.
- TP11 [Reserved]
- TP12 [Reserved]
- TP13 Self-contained breathing apparatus shall be provided when this substance is transported, unless no self-contained breathing apparatus, as required by SOLAS regulation II-2/19 (II-2/54), is on board.
- TP14 [Reserved]
- TP15 [Reserved]
- TP16 The tank shall be fitted with a special device to prevent under-pressure and excess pressure during normal transport conditions. This device shall be approved by the competent authority. Pressure-relief provisions are as indicated in 6.7.2.8.3 to prevent crystallization of the product in the pressure-relief valve.
- TP17 Only inorganic non-combustible materials shall be used for thermal insulation of the tank.
- TP18 Temperature shall be maintained between 18°C and 40°C. Portable tanks containing solidified methacrylic acid shall not be reheated during transport.
- TP19 The calculated shell thickness shall be increased by 3 mm. Shell thickness shall be verified ultrasonically at intervals midway between periodic hydraulic tests.
- TP20 This substance shall only be transported in insulated tanks under a nitrogen blanket.
- TP21 The shell thickness shall be not less than 8 mm. Tanks shall be hydraulically tested and internally inspected at intervals not exceeding 2.5 years.
- TP22 Lubricant for joints or other devices shall be oxygen-compatible.
- TP23 Transport permitted under special conditions prescribed by the competent authorities.
- TP24 The portable tank may be fitted with a device located, under maximum filling conditions, in the vapour space of the shell to prevent the build-up of excess pressure due to the slow decomposition of the substance transported. This device shall also prevent an unacceptable amount of leakage of liquid in the case of overturning or entry of foreign matter into the tank. This device shall be approved by the competent authority or its authorized body.
- TP25 Sulphur trioxide 99.95% pure and above may be transported in tanks without an inhibitor provided that it is maintained at a temperature equal to or above 32.5°C.
- TP26 When transported under heated conditions, the heating device shall be fitted outside the shell. For UN 3176, this provision only applies when the substance reacts dangerously with water.
- TP27 A portable tank having a minimum test pressure of 4 bar may be used if it is shown that a test pressure of 4 bar or less is acceptable according to the test pressure definition in 6.7.2.1.
- TP28 A portable tank having a minimum test pressure of 2.65 bar may be used if it is shown that a test pressure of 2.65 bar or less is acceptable according to the test pressure definition in 6.7.2.1.
- TP29 A portable tank having a minimum test pressure of 1.5 bar may be used if it is shown that a test pressure of 1.5 bar or less is acceptable according to the test pressure definition in 6.7.2.1.
- TP30 This substance shall be transported in insulated tanks.
- TP31 This substance shall be transported in tanks in solid state.
- TP32 For UN 0331, UN 0332 and UN 3375, portable tanks may be used subject to the following conditions:
- (a) To avoid unnecessary confinement, each portable tank constructed of metal shall be fitted with a pressure relief device that may be of the re-closing spring-loaded type, a frangible disc or a fusible element. The set-to-discharge or burst pressure, as applicable, shall not be greater than 2.65 bar for portable tanks with minimum test pressures greater than 4 bar.
  - (b) Suitability for transport in tanks shall be demonstrated. One method to evaluate this suitability is test 8 (d) in Test Series 8 (see United Nations *Manual of Tests and Criteria*, Part 1, sub-section 18.7).

## Part 4 – Packing and tank provisions

- (c) Substances shall not be allowed to remain in the portable tank for any period that could result in caking. Appropriate measures shall be taken to avoid accumulation and packing of substances in the tank (e.g. cleaning, etc).
- TP33 The portable tank instruction assigned for this substance applies for granular and powdered solids and for solids which are filled and discharged at temperatures above their melting point and which are cooled and transported as a solid mass. For solids which are transported above their melting point, see 4.2.1.19.
- TP34 Portable tanks need not be subjected to the impact test in 6.7.4.14.1 if the portable tank is marked "NOT FOR RAIL TRANSPORT" on the plate specified in 6.7.4.15.1 and also in letters at least 10 cm high on both sides of the outer jacket.
- TP35 Portable tank instruction T14 may continue to be applied until 31 December 2014.
- TP36 Fusible elements in the vapour space may be used on portable tanks.
- TP37 Portable tank instruction T14 may continue to be applied until 31 December 2016 except that until that date:
- .1 For UN Nos. 1810, 2474 and 2668, T7 may be applied;
  - .2 For UN No. 2486, T8 may be applied; and
  - .3 For UN No. 1838, T10 may be applied.
- TP38 The portable tank instruction T9 may continue to be applied until 31 December 2018.
- TP39 The portable tank instruction T4 may continue to be applied until 31 December 2018
- TP40 Portable tanks shall not be transported when connected with spray application equipment.
- TP90 Tanks with bottom openings may be used on short international voyages.
- TP91 Portable tanks with bottom openings may also be used on long international voyages.

#### 4.2.6 Additional provisions for the use of road tank vehicles

- 4.2.6.1 The tank of a road tank vehicle shall be attached to the vehicle during normal operations of filling, discharge and transport. IMO type 4 tanks shall be attached to the chassis when transported on board ships. Road tank vehicles shall not be filled or discharged while they remain on board. A road tank vehicle shall be driven on board on its own wheels and be fitted with permanent tie-down attachments for securing on board the ship.
- 4.2.6.2 Road tank vehicles shall comply with the provisions of chapter 6.8. IMO type 4, 6 and 8 tanks may be used according to the provisions of chapter 6.8 for short international voyages only.

## Chapter 4.3

### Use of bulk containers

**Note:** Sheeted bulk containers (BK1) shall not be used for sea transport, except as indicated in 4.3.3.

#### 4.3.1 General provisions

**4.3.1.1** This section provides general requirements applicable to the use of containers for the transport of solid substances in bulk. Substances shall be transported in bulk containers conforming to the applicable bulk container instruction identified by the letters BK in column 13 of the dangerous goods list, with the following meaning:

BK1: the transport in sheeted bulk containers is permitted

BK2: the transport in closed bulk containers is permitted

BK3: the transport in flexible bulk containers is permitted

The bulk container used shall conform to the provisions of chapter 6.9

**4.3.1.2** Except as provided in 4.3.1.3, bulk containers shall only be used when a substance is assigned a bulk container code in column 13 of the Dangerous Goods List.

**4.3.1.3** When a substance is not assigned BK2 or BK3 in column 13 of the dangerous goods list, interim approval for transport may be issued by the competent authority of the country of origin. The approval shall be included in the documentation of the consignment and contain, as a minimum, the information normally provided in the bulk container instruction and the conditions under which the substance shall be transported. Appropriate measures should be initiated by the competent authority to have the assignment included in the Dangerous Goods List. When a substance is not permitted in a BK1 bulk container, an exemption may be issued in accordance with 7.9.1.

**4.3.1.4** Substances which may become liquid at temperatures likely to be encountered during transport are not permitted in bulk containers.

**4.3.1.5** Bulk containers shall be siftproof and shall be so closed that none of the contents can escape under normal conditions of transport, including the effect of vibration, or by changes of temperature, humidity or pressure.

**4.3.1.6** Bulk solids shall be loaded into bulk containers and evenly distributed in a manner that minimizes movement that could result in damage to the container or leakage of the dangerous goods.

**4.3.1.7** Where venting devices are fitted, they shall be kept clear and operable.

**4.3.1.8** Bulk solids shall not react dangerously with the material of the bulk container, gaskets, equipment including lids and tarpaulins, or with protective coatings which are in contact with the contents, or significantly weaken them. Bulk containers shall be so constructed or adapted that the goods cannot penetrate between wooden floor coverings or come into contact with those parts of the bulk containers that may be affected by the dangerous goods or residues thereof.

**4.3.1.9** Before being filled and offered for transport, each bulk container shall be inspected and cleaned to ensure that it does not contain any residue on the interior or exterior that could:

- cause a dangerous reaction with the substance intended for transport;
- detrimentally affect the structural integrity of the bulk container; or
- affect the dangerous goods retention capabilities of the bulk container.

**4.3.1.10** During transport, no dangerous residues shall adhere to the outer surfaces of a bulk container.

**4.3.1.11** If several closure systems are fitted in series, the system which is located nearest to the dangerous goods to be transported shall be closed first before filling.

**4.3.1.12** Empty bulk containers that have contained dangerous goods shall be treated in the same manner as is prescribed in this Code for a filled bulk container, unless adequate measures have been taken to nullify any hazard.

## Part 4 – Packing and tank provisions

- 4.3.1.13 If bulk containers are used for the carriage of bulk goods liable to cause a dust explosion, or evolve flammable vapours (e.g., for certain wastes), measures shall be taken to exclude sources of ignition and to prevent dangerous electrostatic discharge during transport, loading or unloading of the goods.
- 4.3.1.14 Substances, for example wastes, which may react dangerously with one another and substances of different classes and goods not subject to this Code, which are liable to react dangerously with one another, shall not be mixed together in the same bulk container. Dangerous reactions are:
- .1 combustion and/or evolution of considerable heat;
  - .2 emission of flammable and/or toxic gases;
  - .3 formation of corrosive liquids; or
  - .4 formation of unstable substances.
- 4.3.1.15 Before a bulk container is filled, it shall be visually examined to ensure it is structurally serviceable, its interior walls, ceiling and floors are free from protrusions or damage and that any inner liners or substance retaining equipment are free from rips, tears or any damage that would compromise its cargo retention capabilities. "Structurally serviceable" means the bulk container does not have major defects in its structural components, such as top and bottom side rails, top and bottom end rails, door sill and header, floor cross members, corner posts, and corner fittings in a freight container. Major defects include:
- .1 bends, cracks or breaks in the structural or supporting members that affect the integrity of the container;
  - .2 more than one splice or an improper splice (such as a lapped splice) in top or bottom end rails or door headers;
  - .3 more than two splices in any one top or bottom side rail;
  - .4 any splice in a door sill or corner post;
  - .5 door hinges and hardware that are seized, twisted, broken, missing, or otherwise inoperative;
  - .6 gaskets and seals that do not seal;
  - .7 any distortion of the overall configuration great enough to prevent proper alignment of handling equipment, mounting and securing chassis or vehicle, or insertion into ships' cargo spaces;
  - .8 any damage to lifting attachments or handling equipment interface features; or
  - .9 any damage to service or operational equipment.
- 4.3.1.16 Before a flexible bulk container is filled it shall be visually examined to ensure it is structurally serviceable, its textile slings, load-bearing structure straps, body fabric, lock device parts including metal and textile parts are free from protrusions or damage and that inner liners are free from rips, tears or any damage.
- 4.3.1.16.1 For flexible bulk containers, the period of use permitted for the transport of dangerous goods shall be two years from the date of manufacture of the flexible bulk container.
- 4.3.1.16.2 A venting device shall be fitted if a dangerous accumulation of gases may develop within the flexible bulk container. The vent shall be so designed that the penetration of foreign substances is prevented under normal conditions of transport.
- 4.3.2 Additional provisions applicable to bulk goods of classes 4.2, 4.3, 5.1, 6.2, 7 and 8**
- 4.3.2.1 **Bulk goods of class 4.2**
- Only closed bulk containers (BK2) may be used. The total mass carried in a bulk container shall be such that its spontaneous ignition temperature is greater than 55°C.
- 4.3.2.2 **Bulk goods of class 4.3**
- Only closed bulk containers (BK2) may be used. These goods shall be transported in bulk containers which are waterproof.
- 4.3.2.3 **Bulk goods of class 5.1**
- Bulk containers shall be so constructed or adapted that the goods cannot come into contact with wood or any other incompatible material.



**4.3.2.4 Bulk goods of class 6.2**

**4.3.2.4.1 Transport in bulk containers of animal material of class 6.2**

Animal material containing infectious substances (UN Nos. 2814, 2900 and 3373) is authorized for transport in bulk containers provided the following conditions are met:

- .1 Closed bulk containers, and their openings, shall be leakproof by design or by the fitting of a suitable liner.
- .2 The animal material shall be thoroughly treated with an appropriate disinfectant before loading prior to transport.
- .3 Closed bulk containers shall not be re-used until they have been thoroughly cleaned and disinfected.

**Note:** Additional provisions may be required by appropriate national health authorities.

**4.3.2.4.2 Bulk wastes of class 6.2 (UN 3291)**

- .1 only closed bulk containers (BK2) shall be permitted;
- .2 closed bulk containers, and their openings, shall be leakproof by design. These bulk containers shall have non-porous interior surfaces and shall be free from cracks or other features that could damage packagings inside, impede disinfection or permit inadvertent release;
- .3 wastes of UN 3291 shall be contained within the closed bulk container in UN type tested and approved sealed leakproof plastics bags tested for solids of packing group II and marked in accordance with 6.1.3.1. Such plastics bags shall be capable of passing the tests for tear and impact resistance according to ISO 7765-1:1988 "Plastics film and sheeting – Determination of impact resistance by the free-falling dart method – Part 1: Staircase methods" and ISO 6383-2:1983 "Plastics – Film and sheeting – Determination of tear resistance – Part 2: Elmendorf method". Each bag shall have an impact resistance of at least 165 g and a tear resistance of at least 480 g in both parallel and perpendicular planes with respect to the length of the bag. The maximum net mass of each plastics bag shall be 30 kg;
- .4 single articles exceeding 30 kg such as soiled mattresses may be transported without the need for a plastics bag when authorized by the competent authority;
- .5 wastes of UN 3291 which contain liquids shall only be transported in plastics bags containing sufficient absorbent material to absorb the entire amount of liquid without it spilling in the bulk container;
- .6 wastes of UN 3291 containing sharp objects shall only be transported in UN type tested and approved rigid packagings meeting the provisions of packing instructions P621, IBC620 or LP621.
- .7 rigid packagings specified in packing instructions P621, IBC620 or LP621 may also be used. They shall be properly secured to prevent damage during normal conditions of transport. Wastes transported in rigid packagings and plastics bags together in the same closed bulk container shall be adequately segregated from each other, e.g., by suitable rigid barriers or dividers, mesh nets or otherwise securing the packagings, such that they prevent damage to the packagings during normal conditions of transport;
- .8 wastes of UN 3291 in plastics bags shall not be compressed in a closed bulk container in such a way that bags may be rendered no longer leakproof;
- .9 the closed bulk container shall be inspected for leakage or spillage after each journey. If any wastes of UN 3291 have leaked or been spilled in the closed bulk container, it shall not be re-used until after it has been thoroughly cleaned and, if necessary, disinfected or decontaminated with an appropriate agent. No other goods shall be transported together with UN 3291 other than medical or veterinary wastes. Any such other wastes transported in the same closed bulk container shall be inspected for possible contamination.

**4.3.2.5 Bulk material of class 7**

For the transport of unpackaged radioactive material, see 4.1.9.2.3.

**4.3.2.6 Bulk goods of class 8**

Only closed bulk containers (BK2) may be used. These goods shall be transported in bulk containers which are watertight.

**4.3.3 Additional provisions for the use of sheeted bulk containers (BK1)**

**4.3.3.1** Sheeted bulk containers (BK1) shall not be used for sea transport, except for UN 3077 not meeting the criteria of 2.9.3 transported on short international voyages.

**4.3.4 Additional provisions for the use of flexible bulk containers (BK3)**

**4.3.4.1** Flexible bulk containers are only allowed in the holds of general cargo ships. They are not allowed to be transported in cargo transport units.





# **PART 5**

## CONSIGNMENT PROCEDURES



## Chapter 5.1

### *General provisions*

#### **5.1.1 Application and general provisions**

**5.1.1.1** This part sets forth the provisions for dangerous goods consignments relative to authorization of consignments and advance notifications, marking, labelling, documentation (by manual, electronic data processing (EDP) or electronic data interchange (EDI) techniques) and placarding.

**5.1.1.2** Except as otherwise provided in this Code, no person may offer dangerous goods for transport unless those goods are properly marked, labelled, placarded, described and certified on a transport document, and otherwise in a condition for transport as required by this part.

**5.1.1.3.1** A carrier shall not accept dangerous goods for transport unless:

- (a) A copy of the dangerous goods transport document and other documents or information as required by the provisions of this Code are provided; or
- (b) The information applicable to the dangerous goods is provided in electronic form.

**5.1.1.3.2** The information applicable to the dangerous goods shall accompany the dangerous goods to final destination. This information may be on the dangerous goods transport document or may be on another document. This information shall be given to the consignee when the dangerous goods are delivered.

**5.1.1.3.3** When the information applicable to the dangerous goods is given to the carrier in electronic form, the information shall be available to the carrier at all times during transport to final destination. The information shall be able to be produced without delay as a paper document.

**5.1.1.4** The purpose of indicating the Proper Shipping Name (see 3.1.2.1 and 3.1.2.2) and the UN Number of a substance, material or article offered for transport and, in the case of a marine pollutant, of the addition of "marine pollutant" on documentation accompanying the consignment, and of marking the Proper Shipping Name in accordance with 5.2.1 on the package, including IBCs containing the goods, is to ensure that the substance, material or article can be readily identified during transport. This ready identification is particularly important in the case of an accident involving these goods, in order to determine what emergency procedures are necessary to deal properly with the situation and, in the case of marine pollutants, for the master to comply with the reporting requirements of Protocol I of MARPOL 73/78.

#### **5.1.2 Use of overpacks and unit loads**

**5.1.2.1** An overpack and unit load shall be marked with the Proper Shipping Name and the UN Number and marked and labelled, as required for packages by chapter 5.2, for each item of dangerous goods contained in the overpack or unit load unless markings and labels representative of all dangerous goods in the overpack or unit load are visible. An overpack, in addition, shall be marked with the word "OVERPACK" unless markings and labels representative of all dangerous goods, as required by chapter 5.2, in the overpack are visible, except as required in 5.2.2.1.12.

**5.1.2.2** The individual packages comprising a unit load or an overpack shall be marked and labelled in accordance with chapter 5.2. Each package of dangerous goods contained in the unit load or overpack shall comply with all applicable provisions of the Code. The "OVERPACK" marking on an overpack is an indication of compliance with this provision. The intended function of each package shall not be impaired by the unit load or overpack.

**5.1.2.3** Each package bearing package orientation markings as prescribed in 5.2.1.7 of this Code and which is overpacked, placed in a unit load or used as an inner packaging in a large packaging shall be oriented in accordance with such markings.

### 5.1.3 Empty uncleaned packagings or units

- 5.1.3.1 Other than for class 7, a packaging, including an IBC, which previously contained dangerous goods shall be identified, marked, labelled and placarded as required for those dangerous goods unless steps such as cleaning, purging of vapours or refilling with a non-dangerous substance are taken to nullify any hazard.
- 5.1.3.2 Packagings, including IBCs, and tanks used for the transport of radioactive material shall not be used for the transport of other goods unless decontaminated below the level of 0.4 Bq/cm<sup>2</sup> for beta and gamma emitters and low-toxicity alpha emitters and 0.04 Bq/cm<sup>2</sup> for all other alpha emitters.
- 5.1.3.3 Empty cargo transport units still containing residues of dangerous goods, or loaded with empty uncleaned packages or empty uncleaned bulk containers, shall comply with the provisions applicable to the goods last contained in the unit, packagings or bulk container.

### 5.1.4 Mixed packing

When two or more dangerous goods are packed within the same outer packaging, the package shall be labelled and marked as required for each substance. Subsidiary risk labels need not be applied if the hazard is already represented by a primary risk label.

### 5.1.5 General provisions for class 7

#### 5.1.5.1 Approval of shipments and notification

##### 5.1.5.1.1 General

In addition to the approval for package designs described in chapter 6.4, multilateral shipment approval is also required in certain circumstances (5.1.5.1.2 and 5.1.5.1.3). In some circumstances it is also necessary to notify competent authorities of a shipment (5.1.5.1.4).

##### 5.1.5.1.2 Shipment approvals

Multilateral approval shall be required for:

- .1 the shipment of Type B(M) packages not conforming with the provisions of 6.4.7.5 or designed to allow controlled intermittent venting;
- .2 the shipment of Type B(M) packages containing radioactive material with an activity greater than 3000A<sub>1</sub> or 3000A<sub>2</sub>, as appropriate, or 1000 TBq, whichever is the lower;
- .3 the shipment of packages containing fissile materials if the sum of the criticality safety indexes of the packages in a single freight container or in a single conveyance exceeds 50. Excluded from this requirement shall be shipments by seagoing vessels, if the sum of the criticality safety indexes does not exceed 50 for any hold, compartment or defined deck area and the distance of 6 m between groups of packages or overpacks as required in table 7.1.4.5.3.4 is met; and
- .4 radiation protection programmes for shipments by special use vessels according to 7.1.4.5.7

except that a competent authority may authorize transport into or through its country without shipment approval, by a specific provision in its design approval (see 5.1.5.2.1).

##### 5.1.5.1.3 Shipment approval by special arrangement

Provisions may be approved by a competent authority under which a consignment which does not satisfy all of the applicable provisions of this Code may be transported under special arrangement (see 1.5.4).

##### 5.1.5.1.4 Notifications

Notification to competent authorities is required as follows:

- .1 Before the first shipment of any package requiring competent authority approval, the consignor shall ensure that copies of each applicable competent authority certificate applying to that package design have been submitted to the competent authority of the country of origin of the shipment and to the competent authority of each country through or into which the consignment is to be transported. The consignor is not required to await an acknowledgement from the competent authority, nor is the competent authority required to make such acknowledgement of receipt of the certificate.
- .2 For each of the following types of shipments:
  - .1 Type C packages containing radioactive material with an activity greater than 3000A<sub>1</sub> or 3000A<sub>2</sub>, as appropriate, or 1000 TBq, whichever is the lower;

- .2 Type B(U) packages containing radioactive material with an activity greater than  $3000A_1$  or  $3000A_2$ , as appropriate, or 1000 TBq, whichever is the lower;
- .3 Type B(M) packages;
- .4 shipment under special arrangement

the consignor shall notify the competent authority of the country of origin of the shipment and the competent authority of each country through or into which the consignment is to be transported. This notification shall be in the hands of each competent authority prior to the commencement of the shipment, and preferably at least 7 days in advance.

- .3 The consignor is not required to send a separate notification if the required information has been included in the application for shipment approval.
- .4 The consignment notification shall include:
  - .1 sufficient information to enable the identification of the package or packages, including all applicable certificate numbers and identification marks;
  - .2 information on the date of shipment, the expected date of arrival and proposed routing;
  - .3 the names of the radioactive material or nuclides;
  - .4 descriptions of the physical and chemical forms of the radioactive material, or whether it is special form radioactive material or low dispersible radioactive material; and
  - .5 the maximum activity of the radioactive contents during transport, expressed in units of becquerels (Bq) with an appropriate SI prefix symbol (see 1.2.2.1). For fissile material, the mass of fissile material (or of each fissile nuclide for mixtures when appropriate) in units of grams (g), or multiples thereof, may be used in place of activity.

#### 5.1.5.2 Certificates issued by competent authority

5.1.5.2.1 Certificates issued by the competent authority are required for the following:

- .1 Designs for:
  - .1 special form radioactive material;
  - .2 low dispersible radioactive material;
  - .3 packages containing 0.1 kg or more of uranium hexafluoride;
  - .4 all packages containing fissile material unless excepted by 6.4.11.2;
  - .5 Type B(U) packages and Type B(M) packages;
  - .6 Type C packages;
- .2 Special arrangements;
- .3 Certain shipments (see 5.1.5.1.2).

The certificates shall confirm that the applicable provisions are met, and for design approvals shall attribute to the design an identification mark.

The package design and shipment approval certificates may be combined into a single certificate.

Certificates and applications for these certificates shall be in accordance with the provisions in 6.4.23.

5.1.5.2.2 The consignor shall be in possession of a copy of each applicable certificate.

5.1.5.2.3 For package designs where a competent authority issued certificate is not required, the consignor shall, on request, make available, for inspection by the relevant competent authority, documentary evidence of the compliance of the package design with all the applicable provisions.

#### 5.1.5.3 Determination of transport index (TI) and criticality safety index (CSI)

5.1.5.3.1 The transport index (TI) for a package, overpack or freight container, or for unpackaged LSA-I or SCO-I, shall be the number derived in accordance with the following procedure:

- .1 Determine the maximum radiation level in units of millisieverts per hour (mSv/h) at a distance of 1 m from the external surfaces of the package, overpack, freight container, or unpackaged LSA-I and SCO-I. The value determined shall be multiplied by 100 and the resulting number is the transport index. For uranium and thorium ores and their concentrates, the maximum radiation level at any point 1 m from the external surface of the load may be taken as:
  - 0.4 mSv/h for ores and physical concentrates of uranium and thorium;
  - 0.3 mSv/h for chemical concentrates of thorium;
  - 0.02 mSv/h for chemical concentrates of uranium, other than uranium hexafluoride;
- .2 For tanks, freight containers and unpackaged LSA-I and SCO-I, the value determined in 5.1.5.3.1.1 above shall be multiplied by the appropriate factor from table 5.1.5.3.1;

Part 5 – Consignment procedures

- .3 The value obtained in 5.1.5.3.1.1 and 5.1.5.3.1.2 above shall be rounded up to the first decimal place (e.g., 1.13 becomes 1.2), except that a value of 0.05 or less may be considered as zero.

Table 5.1.5.3.1 – Multiplication factors for tanks, freight containers and unpackaged LSA-I and SCO-I

Size of load <sup>a</sup>	Multiplication factor
size of load $\leq 1 \text{ m}^2$	1
$1 \text{ m}^2 < \text{size of load} \leq 5 \text{ m}^2$	2
$5 \text{ m}^2 < \text{size of load} \leq 20 \text{ m}^2$	3
$20 \text{ m}^2 < \text{size of load}$	10

<sup>a</sup> Largest cross-sectional area of the load being measured.

- 5.1.5.3.2 The transport index for each overpack, freight container or conveyance shall be determined as either the sum of the TIs of all the packages contained, or by direct measurement of radiation level, except in the case of non-rigid overpacks for which the transport index shall be determined only as the sum of the TIs of all the packages.
- 5.1.5.3.3 The criticality safety index for each overpack or freight container shall be determined as the sum of the CSIs of all the packages contained. The same procedure shall be followed for determining the total sum of the CSIs in a consignment or aboard a conveyance.
- 5.1.5.3.4 Packages and overpacks shall be assigned to either category I – WHITE, II – YELLOW or III – YELLOW in accordance with the conditions specified in table 5.1.5.3.4 and with the following requirements:
- .1 For a package or overpack, both the transport index and the surface radiation level conditions shall be taken into account in determining which is the appropriate category. Where the transport index satisfies the condition for one category but the surface radiation level satisfies the condition for a different category, the package or overpack shall be assigned to the higher category. For this purpose, category I – WHITE shall be regarded as the lowest category;
  - .2 The transport index shall be determined following the procedures specified in 5.1.5.3.1 and 5.1.5.3.2;
  - .3 If the surface radiation level is greater than 2 mSv/h, the package or overpack shall be transported under exclusive use and under the provisions of 7.1.4.5.6 or 7.1.4.5.7, as appropriate;
  - .4 A package transported under a special arrangement shall be assigned to category III – YELLOW except under the provisions of 5.1.5.3.5;
  - .5 An overpack which contains packages transported under special arrangement shall be assigned to category III – YELLOW except under the provisions of 5.1.5.3.5.

Table 5.1.5.3.4 – Categories of packages and overpacks

Transport index	Conditions	
	Maximum radiation level at any point on external surface	Category
0 <sup>a</sup>	Not more than 0.005 mSv/h	I – WHITE
More than 0 but not more than 1 <sup>a</sup>	More than 0.005 mSv/h but not more than 0.5 mSv/h	II – YELLOW
More than 1 but not more than 10	More than 0.5 mSv/h but not more than 2 mSv/h	III – YELLOW
More than 10	More than 2 mSv/h but not more than 10 mSv/h	III – YELLOW <sup>b</sup>

<sup>a</sup> If the measured TI is not greater than 0.05, the value quoted may be zero in accordance with 5.1.5.3.1.3.

<sup>b</sup> Shall also be transported under “exclusive use”.

- 5.1.5.3.5 In all cases of international transport of packages requiring competent authority design or shipment approval, for which different approval types apply in the different countries concerned by the shipment, the categorization shall be in accordance with the certificate of the country of origin of design.
- 5.1.5.4 Specific provisions for excepted packages
- 5.1.5.4.1 Excepted packages shall be legibly and durably marked on the outside of the packaging with:
- .1 The UN Number preceded by the letters “UN”;
  - .2 An identification of either the consignor or consignee, or both; and
  - .3 The permissible gross mass if this exceeds 50 kg.



5.1.5.4.2 The documentation provisions of chapter 5.4 do not apply to excepted packages of radioactive material, except that the UN Number preceded by the letters “UN”, and the name and address of the consignor and the consignee shall be shown on a transport document such as a bill of lading, air waybill or other similar document.

## **5.1.6 Packages packed into a cargo transport unit**

5.1.6.1 Regardless of the placarding and marking provisions for cargo transport units, each package containing dangerous goods packed into a cargo transport unit shall be marked and labelled in accordance with the requirements of chapter 5.2.

## Chapter 5.2

### *Marking and labelling of packages including IBCs*

---

**Note:** These provisions relate essentially to the marking and labelling of dangerous goods according to their properties. However, additional markings or symbols indicating precautions to be taken in handling or storing a package (such as a symbol representing an umbrella, indicating that a package shall be kept dry) may be displayed on a package if appropriate.

#### 5.2.1 Marking of packages including IBCs

5.2.1.1 Unless provided otherwise in this Code, the Proper Shipping Name for the dangerous goods as determined in accordance with 3.1.2 and the corresponding UN Number, preceded by the letters "UN", shall be displayed on each package. The UN number and the letters "UN" shall be at least 12 mm high, except for packagings of 30 ℓ or 30 kg capacity or less and except for cylinders of 60 ℓ water capacity or less, when they shall be at least 6 mm in height and for packagings of 5 ℓ or 5 kg or less when they shall be of an appropriate size. In the case of unpackaged articles, the marking shall be displayed on the article, on its cradle or on its handling, storage or launching device. For goods of division 1.4, compatibility group S, the division and compatibility group letter shall also be marked unless the label for 1.4S is displayed. A typical package marking is:

CORROSIVE LIQUID, ACIDIC, ORGANIC, N.O.S. (caprylyl chloride) UN 3265.

**Note:** Cylinders of 60 ℓ water capacity or less marked with a UN number in accordance with the provisions of the IMDG Code up to 31 December 2013 and which do not conform to the provisions of 5.2.1.1 regarding the size of the UN number and of the letters "UN" applicable as from 1 January 2014 may continue to be used until the next periodic inspection but no later than 1 July 2018.

5.2.1.2 All package markings required by 5.2.1.1:

- .1 shall be readily visible and legible;
- .2 shall be such that this information will still be identifiable on packages surviving at least three months' immersion in the sea. In considering suitable marking methods, account shall be taken of the durability of the packaging materials used and the surface of the package;
- .3 shall be displayed on a background of contrasting colour on the external surface of the package; and
- .4 shall not be located with other package markings that could substantially reduce their effectiveness.

5.2.1.3 Salvage packagings and salvage pressure receptacles shall additionally be marked with the word "SALVAGE".

5.2.1.4 Intermediate bulk containers of more than 450 ℓ capacity and large packagings shall be marked on two opposing sides.

#### 5.2.1.5 Special marking provisions for class 7

5.2.1.5.1 Each package shall be legibly and durably marked on the outside of the packaging with an identification of either the consignor or consignee, or both.

5.2.1.5.2 The marking of excepted packages shall be as required by 5.1.5.4.1.

5.2.1.5.3 Each package of gross mass exceeding 50 kg shall have its permissible gross mass legibly and durably marked on the outside of the packaging.

5.2.1.5.4 Each package which conforms to:

- .1 a Type IP-1 package, a Type IP-2 package or a Type IP-3 package design shall be legibly and durably marked on the outside of the packaging with "TYPE IP-1", "TYPE IP-2" or "TYPE IP-3" as appropriate;
- .2 a Type A package design shall be legibly and durably marked on the outside of the packaging with "TYPE A";
- .3 a Type IP-2 package, a Type IP-3 package or a Type A package design shall be legibly and durably marked on the outside of the packaging with the international vehicle registration code (VRI code) of the country of origin of design and either the name of the manufacturer or other identification of the packaging specified by the competent authority of the country of origin of design.

- 5.2.1.5.5 Each package which conforms to a design approved by the competent authority under 6.4.22.1–6.4.22.5 or 6.4.24.2–6.4.24.3 shall be legibly and durably marked on the outside of the packaging with:
- .1 the identification mark allocated to that design by the competent authority;
  - .2 a serial number to uniquely identify each packaging which conforms to that design;
  - .3 in the case of a Type B(U) or Type B(M) package design, with “TYPE B(U)” or “TYPE B(M)”;
  - .4 in the case of a Type C package design, with “TYPE C”.
- 5.2.1.5.6 Each package which conforms to a Type B(U), Type B(M) or Type C package design shall have the outside of the outermost receptacle which is resistant to the effects of fire and water plainly marked by embossing, stamping or other means resistant to the effects of fire and water with the trefoil symbol shown below.

Basic trefoil symbol with proportions based on a central circle of radius  $X$ .  
 The minimum allowable size of  $X$  shall be 4 mm.

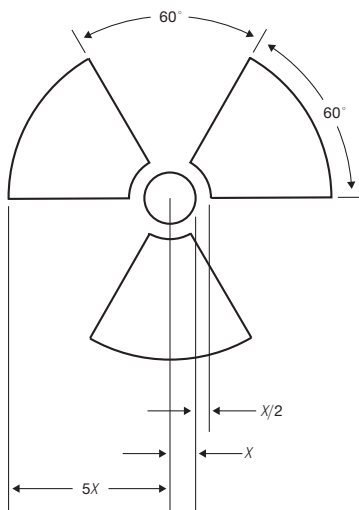

- 5.2.1.5.7 Where LSA-I or SCO-I material is contained in receptacles or wrapping materials and is transported under exclusive use as permitted by 4.1.9.2.3, the outer surface of these receptacles or wrapping materials may bear the marking “RADIOACTIVE LSA-I” or “RADIOACTIVE SCO-I”, as appropriate.
- 5.2.1.5.8 In all cases of international transport of packages requiring competent authority design or shipment approval, for which different approval types apply in the different countries concerned by the shipment, marking shall be in accordance with the certificate of the country of origin of the design.
- 5.2.1.6 **Special marking provisions for marine pollutants**
- 5.2.1.6.1 Packages containing marine pollutants meeting the criteria of 2.9.3 shall be durably marked with the environmentally hazardous substance mark with the exception of single packagings and combination packagings where such single packagings or inner packagings of such combination packagings have:
- a net quantity of 5 ℓ or less for liquids; or
  - a net mass of 5 kg or less for solids.
- 5.2.1.6.2 The marine pollutant mark shall be located adjacent to the markings required by 5.2.1.1. The provisions of 5.2.1.2 and 5.2.1.4 shall be met.

Part 5 – Consignment procedures

5.2.1.6.3 The marine pollutant mark shall be as shown below. For packagings, the dimensions shall be at least 100 mm × 100 mm, except in the case of packages of such dimensions that they can only bear smaller marks.

Marine pollutant mark



Symbol (fish and tree): black on white or suitable contrasting background

**NOTE:** The labelling provisions of 5.2.2 apply in addition to any requirement for packages to bear the environmentally hazardous substance mark

5.2.1.7 Except as provided in 5.2.1.7.1:

- combination packagings having inner packagings containing liquid dangerous goods;
- single packagings fitted with vents; and
- cryogenic receptacles intended for the transport of refrigerated liquefied gases

shall be legibly marked with package orientation arrows which are similar to the illustration shown below or with those meeting the specifications of ISO 780:1997. The orientation arrows shall appear on two opposite vertical sides of the package with the arrows pointing in the correct upright direction. They shall be rectangular and of a size that is clearly visible commensurate with the size of the package. Depicting a rectangular border around the arrows is optional.

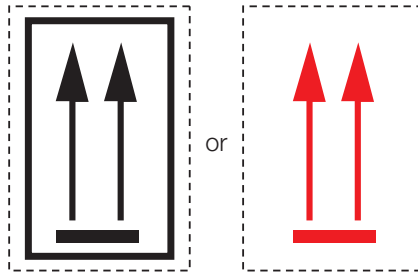

Two black or red arrows on white or suitable contrasting background.  
The rectangular border is optional

5.2.1.7.1 Orientation arrows are not required on:

- (a) Outer packagings containing pressure receptacles except cryogenic receptacles;
- (b) Outer packagings containing dangerous goods in inner packagings each containing not more than 120 ml, with sufficient absorbent material between the inner and outer packagings to completely absorb the liquid contents;
- (c) Outer packagings containing Division 6.2 infectious substances in primary receptacles each containing not more than 50 ml;
- (d) Type IP-2, type IP-3, type A, type B(U), type B(M) or type C packages containing Class 7 radioactive material;
- (e) Outer packagings containing articles which are leak-tight in all orientations (e.g., alcohol or mercury in thermometers, aerosols, etc.); or
- (f) Outer packagings containing dangerous goods in hermetically sealed inner packagings each containing not more than 500 ml.

5.2.1.7.2 Arrows for purposes other than indicating proper package orientation shall not be displayed on a package marked in accordance with this sub-section.

**5.2.1.8 Excepted quantity mark**

5.2.1.8.1 Packages containing excepted quantities of dangerous goods shall be marked according to 3.5.4.

**5.2.1.9 Limited quantity mark**

5.2.1.9.1 Packages containing dangerous goods packed in limited quantities shall be marked according to 3.4.5.

**5.2.2 Labelling of packages including IBCs**

**5.2.2.1 Labelling provisions**

These provisions are related essentially to danger labels. However, additional markings or symbols indicating precautions to be taken in handling or storing a package (such as a symbol representing an umbrella, indicating that a package shall be kept dry) may be displayed on a package if appropriate.

5.2.2.1.1 Labels identifying primary and subsidiary risks shall conform to models Nos. 1 to 9 illustrated in 5.2.2.2.2. The “EXPLOSIVE” subsidiary risk label is model No. 1.

5.2.2.1.2 Where articles or substances are specifically listed in the Dangerous Goods List, a danger class label shall be affixed for the hazard shown in column 3. A subsidiary risk label shall also be affixed for any risk indicated by a class or division number in column 4 of the Dangerous Goods List. However, special provisions indicated in column 6 may also require a subsidiary risk label where no subsidiary risk is indicated in column 4 or may exempt from the requirement for a subsidiary risk label where such a risk is indicated in the Dangerous Goods List.

5.2.2.1.2.1 A package containing a dangerous substance which has a low degree of danger may be exempt from these labelling requirements. In this case, a special provision specifying that no hazard label is required appears in column 6 of the Dangerous Goods List for the relevant substance. However, for certain substances the package shall be marked with the appropriate text as it appears in the special provision, e.g.:

Substance	UN No.	Class	Mark required on bales
Baled hay in cargo transport unit	UN 1327	4.1	None
Baled hay not in cargo transport unit	UN 1327	4.1	Class 4.1
Baled dry vegetable fibres in cargo transport unit	UN 3360	4.1	None

Substance	UN No.	Class	Mark required on packages in addition to the Proper Shipping Name and UN Number
Fishmeal*	UN 1374	4.2	Class 4.2†
Batteries, wet, non-spillable	UN 2800	8	Class 8‡

\* Only applicable to fishmeal in packing group III.

† Exempt from class marking when loaded in a cargo transport unit containing only fishmeal under UN 1374.

‡ Exempt from class marking when loaded in a cargo transport unit containing only batteries under UN 2800.

5.2.2.1.3 Except as provided in 5.2.2.1.3.1, if a substance which meets the definition of more than one class is not specifically listed by name in the Dangerous Goods List in chapter 3.2, the provisions in chapter 2.0 shall be used to determine the primary risk class of the goods. In addition to the label required for that primary risk class, subsidiary risk labels shall also be applied as specified in the Dangerous Goods List.

5.2.2.1.3.1 Packagings containing substances of class 8 need not bear subsidiary risk label model No. 6.1 if the toxicity arises solely from the destructive effect on tissue. Substances of class 4.2 need not bear subsidiary risk label model No. 4.1.

Part 5 – Consignment procedures

5.2.2.1.4 *Labels for class 2 gases with subsidiary risk(s)*

Class	Subsidiary risk(s) shown in chapter 2.2	Primary risk label	Subsidiary risk label(s)
2.1	None	2.1	None
2.2	None	2.2	None
	5.1	2.2	5.1
2.3	None	2.3	None
	2.1	2.3	2.1
	5.1	2.3	5.1
	5.1, 8	2.3	5.1, 8
	8	2.3	8
	2.1, 8	2.3	2.1, 8

5.2.2.1.5 Three separate labels have been provided for class 2, one for flammable gases of class 2.1 (red), one for non-flammable, non-toxic gases of class 2.2 (green) and one for toxic gases of class 2.3 (white). Where the Dangerous Goods List indicates that a class 2 gas possesses single or multiple subsidiary risks, labels shall be used in accordance with the table in 5.2.2.1.4.

5.2.2.1.6 Except as provided in 5.2.2.1.2, each label shall:

- .1 be located on the same surface of the package near the Proper Shipping Name marking, if the package dimensions are adequate;
- .2 be so placed on the packaging that it is not covered or obscured by any part or attachment to the packaging or any other label or marking; and
- .3 when primary and subsidiary risk labels are required, be displayed next to each other.

Where a package is of such an irregular shape or small size that a label cannot be satisfactorily affixed, the label may be attached to the package by a securely affixed tag or other suitable means.

5.2.2.1.7 Intermediate bulk containers of more than 450 ℓ capacity and large packagings shall be labelled on two opposing sides.

5.2.2.1.8 Labels shall be affixed on a surface of contrasting colour.

5.2.2.1.9 *Special provisions for the labelling of self-reactive substances*

An “EXPLOSIVE” subsidiary risk label (No. 1) shall be applied for type B self-reactive substances, unless the competent authority has permitted this label to be dispensed with for a specific packaging because test data have proved that the self-reactive substance in such a packaging does not exhibit explosive behaviour.

5.2.2.1.10 *Special provisions for the labelling of organic peroxides*

The class 5.2 label (model No. 5.2) shall be affixed to packages containing organic peroxides classified as types B, C, D, E or F. This label also implies that the product may be flammable and hence no “FLAMMABLE LIQUID” subsidiary risk label (model No. 3) is required. In addition, the following subsidiary risk labels shall be applied:

- .1 An “EXPLOSIVE” subsidiary risk label (model No. 1) for organic peroxides type B, unless the competent authority has permitted this label to be dispensed with for a specific packaging because test data have proved that the organic peroxide in such a packaging does not exhibit explosive behaviour.
- .2 A “CORROSIVE” subsidiary risk label (model No. 8) is required when packing group I or II criteria of class 8 are met.

5.2.2.1.11 *Special provisions for the labelling of infectious substances packages*

In addition to the primary risk label (model No. 6.2), infectious substances packages shall bear any other label required by the nature of the contents.

5.2.2.1.12 *Special provisions for the labelling of radioactive material*

5.2.2.1.12.1 Except when enlarged labels are used in accordance with 5.3.1.1.5.1, each package, overpack and freight container containing radioactive material shall bear at least two labels which conform to the models Nos. 7A, 7B, and 7C, as appropriate, according to the category (see 5.1.5.3.4) of that package, overpack or freight container. Labels shall be affixed to two opposite sides on the outside of the package or on the outside of all four sides of the freight container. Each overpack containing radioactive material shall bear at least two labels on opposite sides of the outside of the overpack. In addition, each package, overpack and freight container containing fissile material, other than fissile material excepted under the provisions of 6.4.11.2, shall bear labels which conform to model No. 7E; such labels, where applicable, shall be affixed adjacent to the labels

for radioactive material. Labels shall not cover the markings specified in this chapter. Any labels which do not relate to the contents shall be removed or covered.

- 5.2.2.1.12.2 Each label conforming to the models Nos. 7A, 7B and 7C shall be completed with the following information:
- .1 **Contents:**
    - .1 Except for LSA-I material, the name(s) of the radionuclide(s) as taken from the table under 2.7.2.2.1, using the symbols prescribed therein. For mixtures of radionuclides, the most restrictive nuclides must be listed to the extent the space on the line permits. The group of LSA or SCO shall be shown following the name(s) of the radionuclide(s). The terms “LSA-II”, “LSA-III”, “SCO-I” and “SCO-II” shall be used for this purpose.
    - .2 For LSA-I material, the term “LSA-I” is all that is necessary; the name of the radionuclide is not necessary.
  - .2 **Activity:** The maximum activity of the radioactive contents during transport, expressed in units of becquerels (Bq) with the appropriate SI prefix symbol (see 1.2.2.1). For fissile material, the mass of fissile material (or mass of each fissile nuclide for mixtures when appropriate) in units of grams (g), or multiples thereof, may be used in place of activity.
  - .3 For overpacks and freight containers, the “contents” and “activity” entries on the label shall bear the information required in 5.2.2.1.12.2.1 and 5.2.2.1.12.2.2, respectively, totalled together for the entire contents of the overpack or freight container except that, on labels for overpacks or freight containers containing mixed loads of packages containing different radionuclides, such entries may read “See transport documents”.
  - .4 **Transport index:** The number determined in accordance with 5.1.5.3.1 and 5.1.5.3.2. (No transport index entry is required for category I – WHITE.)
- 5.2.2.1.12.3 Each label conforming to the model No. 7E shall be completed with the criticality safety index (CSI) as stated in the certificate of approval for special arrangement or the certificate of approval for the package design issued by the competent authority.
- 5.2.2.1.12.4 For overpacks and freight containers, the criticality safety index (CSI) on the label shall bear the information required in 5.2.2.1.12.3 totalled together for the fissile contents of the overpack or freight container.
- 5.2.2.1.12.5 In all cases of international transport of packages requiring competent authority design or shipment approval, for which different approval types apply in the different countries concerned by the shipment, labelling shall be in accordance with the certificate of the country of origin of design.
- 5.2.2.2 **Provisions for labels**
- 5.2.2.2.1 Labels shall satisfy the provisions of this section and conform, in terms of colour, symbols, numbers and general format, to the specimen labels shown in 5.2.2.2.2.
- Note:** Where appropriate, labels in 5.2.2.2.2 are shown with a dotted outer boundary as provided for in 5.2.2.2.1. This is not required when the label is applied on a background of contrasting colour.
- 5.2.2.2.1.1 Labels shall be in the form of a square set at an angle of 45° (diamond-shaped) with minimum dimensions of 100 mm by 100 mm, except in the case of packages of such dimensions that they can only bear smaller labels and as provided in 5.2.2.2.1.2. They shall have a line 5 mm inside the edge and running parallel with it. In the upper half of a label the line shall have the same colour as the symbol and in the lower half it shall have the same colour as the figure in the bottom corner. Labels shall be displayed on a background of contrasting colour, or shall have either a dotted or solid outer boundary line.
- 5.2.2.2.1.2 Cylinders for class 2 may, on account of their shape, orientation and securing mechanisms for transport, bear labels representative of those specified in this section, which have been reduced in size, according to ISO 7225:2005, for display on the non-cylindrical part (shoulder) of such cylinders. Labels may overlap to the extent provided for by ISO 7225:2005 “Gas cylinders – Precautionary labels”; however, in all cases, the labels representing the primary hazard and the numbers appearing on any label shall remain fully visible and the symbols recognizable.
- 5.2.2.2.1.3 With the exception of labels for divisions 1.4, 1.5 and 1.6 of class 1, the upper half of the label shall contain the pictorial symbol and the lower half shall contain the class number 1, 2, 3, 4, 5.1, 5.2, 6, 7, 8 or 9 as appropriate. The label may include text such as the UN Number, or words describing the hazard class (e.g., “flammable”) in accordance with 5.2.2.2.1.5 provided the text does not obscure or detract from the other required label elements.
- 5.2.2.2.1.4 In addition, except for divisions 1.4, 1.5 and 1.6, labels for class 1 shall show in the lower half, above the class number, the division number and compatibility group letter for the substance or article. Labels for divisions 1.4, 1.5 and 1.6 shall show in the upper half the division number and in the lower half the class number and

**Part 5 – Consignment procedures**

---

the compatibility group letter. For division 1.4, compatibility group S, no label is generally required. However, in cases where a label is considered necessary for such goods, it shall be based on model No. 1.4.

- 5.2.2.2.1.5 On labels other than those for material of class 7, the insertion of any text (other than the class or division number) in the space below the symbol shall be confined to particulars indicating the nature of the risk and precautions to be taken in handling.
- 5.2.2.2.1.6 The symbols, text and numbers shall be shown in black on all labels except for:
- .1 the class 8 label, where the text (if any) and class number shall appear in white;
  - .2 labels with entirely green, red or blue backgrounds, where they may be shown in white;
  - .3 the class 5.2 label, where the symbol may be shown in white; and
  - .4 class 2.1 labels displayed on cylinders and gas cartridges for liquefied petroleum gases, where they may be shown in the background colour of the receptacle if adequate contrast is provided
- 5.2.2.2.1.7 The method of affixing the label(s) or applying stencil(s) of label(s) on packages containing dangerous goods shall be such that the label(s) or stencil(s) will still be identifiable on packages surviving at least three months' immersion in the sea. In considering suitable labelling methods, account shall be taken of the durability of the packaging materials used and the surface of the package.



5.2.2.2.2 Specimen labels

Class 1 – Explosive substances or articles



(No. 1)  
Divisions 1.1, 1.2 and 1.3

Symbol (exploding bomb): black. Background: orange. Figure '1' in bottom corner.



(No. 1.4)  
Division 1.4



(No. 1.5)  
Division 1.5



(No. 1.6)  
Division 1.6

Background: orange. Figures: black. Numerals shall be about 30 mm in height and be about 5 mm thick (for a label measuring 100 mm × 100 mm). Figure '1' in bottom corner.

\*\* Place for division – to be left blank if explosive is the subsidiary risk.

\* Place for compatibility group – to be left blank if explosive is the subsidiary risk.

Class 2 – Gases



(No. 2.1)  
Class 2.1  
Flammable gases

Symbol (flame): black or white  
(except as provided for in 5.2.2.2.1.6.4).  
Background: red. Figure '2' in bottom corner.



(No. 2.2)  
Class 2.2

Non-flammable, non-toxic gases  
Symbol (gas cylinder): black or white.  
Background: green. Figure '2' in bottom corner.



Class 3 – Flammable liquids



(No. 2.3)  
Class 2.3  
Toxic gases

Symbol (skull and crossbones): black.  
Background: white. Figure '2' in bottom corner.



(No. 3)  
Symbol (flame): black or white.  
Background: red. Figure '3' in bottom corner.

Part 5 – Consignment procedures

Class 4



(No. 4.1)  
Class 4.1  
**Flammable solids**  
Symbol (flame): black.  
Background: white with seven vertical red stripes.  
Figure '4' in bottom corner.



(No. 4.2)  
Class 4.2  
**Substances liable to spontaneous combustion**  
Symbol (flame): black.  
Background: upper half white, lower half red.  
Figure '4' in bottom corner.



(No. 4.3)  
Class 4.3  
**Substances which, in contact with water, emit flammable gases**  
Symbol (flame): black or white.  
Background: blue.  
Figure '4' in bottom corner.



Class 5



(No. 5.1)  
Class 5.1  
**Oxidizing substances**  
Symbol (flame over circle): black;  
Background: yellow.  
Figure '5.1' in bottom corner.



(No. 5.2)  
Class 5.2  
**Organic peroxides**  
Symbol (flame): black or white;  
Background: upper half red; lower half yellow;  
Figure '5.2' in bottom corner



Class 6



(No. 6.1)  
Class 6.1  
**Toxic substances**  
Symbol (skull and crossbones): black.  
Background: white. Figure '6' in bottom corner.



(No. 6.2)  
Class 6.2  
**Infectious substances**  
The lower half of the label may bear the inscriptions **INFECTIOUS SUBSTANCE** and **In case of damage or leakage immediately notify Public Health Authority.**  
Symbol (three crescents superimposed on a circle) and inscriptions: black.  
Background: white. Figure '6' in bottom corner.

Class 7 – Radioactive material



(No. 7A)  
Category I – White

Symbol (trefoil): black.  
Background: white.  
Text (mandatory): black in lower half of label:  
RADIOACTIVE  
CONTENTS ...  
ACTIVITY ...  
One red bar shall follow the word RADIOACTIVE.  
Figure '7' in bottom corner.



(No. 7B)  
Category II – Yellow

Symbol (trefoil): black.  
Background: upper half yellow with white border, lower half white.  
Text (mandatory): black in lower half of label:  
RADIOACTIVE  
CONTENTS ...  
ACTIVITY ...  
In a black outlined box: TRANSPORT INDEX ...  
Two red vertical bars shall follow the word RADIOACTIVE.



(No. 7C)  
Category III – Yellow

Symbol (trefoil): black.  
Background: upper half yellow with white border, lower half white.  
Text (mandatory): black in lower half of label:  
RADIOACTIVE  
CONTENTS ...  
ACTIVITY ...  
In a black outlined box: TRANSPORT INDEX ...  
Three red vertical bars shall follow the word RADIOACTIVE.  
Figure '7' in bottom corner.

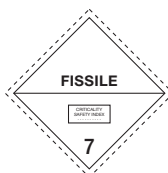

(No. 7E)  
Class 7 fissile material

Background: white.  
Text (mandatory): black in upper half of label: FISSILE.  
In a black outlined box in the lower half of the label: CRITICALITY SAFETY INDEX ...  
Figure '7' in bottom corner.

Class 8 – Corrosive substances



(No. 8)

Symbol (liquids, spilling from two glass vessels and attacking a hand and a metal): black.  
Background: upper half white; lower half black with white border.  
Figure '8' in bottom corner.\*

\* A class 8 label with a shaded hand may also be used.

Class 9 – Miscellaneous dangerous substances and articles

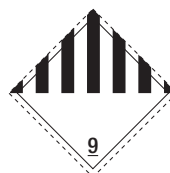

(No. 9)

Symbol (seven vertical stripes in upper half): black.  
Background: white.  
Figure '9' underlined in bottom corner.

## Chapter 5.3

### *Placarding and marking of cargo transport units*

---

#### 5.3.1 Placarding

##### 5.3.1.1 Placarding provisions

###### 5.3.1.1.1 *General provisions*

- .1 Enlarged labels (placards) and marks and signs shall be affixed to the exterior surfaces of a cargo transport unit to provide a warning that the contents of the unit are dangerous goods and present risks, unless the labels and/or marks affixed to the packages are clearly visible from the exterior of the cargo transport unit;
- .2 the methods of placarding and marking as required in 5.3.1.1.4 and 5.3.2 on cargo transport units shall be such that this information will still be identifiable on cargo transport units surviving at least three months' immersion in the sea. In considering suitable marking methods, account shall be taken of the ease with which the surface of the cargo transport unit can be marked; and
- .3 all placards, orange panels, marks and signs shall be removed from cargo transport units or masked as soon as both the dangerous goods or their residues which led to the application of those placards, orange panels, marks or signs are discharged.

###### 5.3.1.1.2 Placards shall be affixed to the exterior surface of cargo transport units to provide a warning that the contents of the unit are dangerous goods and present risks. Placards shall correspond to the primary risk of the goods contained in the cargo transport unit except that:

- .1 placards are not required on cargo transport units carrying any quantity of explosives of division 1.4, compatibility group S; and
- .2 placards indicating the highest risk only need be affixed on cargo transport units carrying substances and articles of more than one division in class 1.

Placards shall be displayed on a background of contrasting colour, or shall have either a dotted or solid outer boundary line.

###### 5.3.1.1.3 Placards shall also be displayed for those subsidiary risks for which a subsidiary risk label is required according to 5.2.2.1.2. However, cargo transport units containing goods of more than one class need not bear a subsidiary risk placard if the hazard represented by that placard is already indicated by a primary risk placard.

###### 5.3.1.1.4 *Placarding requirements*

###### 5.3.1.1.4.1 A cargo transport unit containing dangerous goods or residues of dangerous goods shall clearly display placards as follows:

- .1 *a freight container, semi-trailer or portable tank*: one on each side and one on each end of the unit;
- .2 *a railway wagon*: at least on each side;
- .3 *a multiple-compartment tank containing more than one dangerous substance or their residues*: along each side at the positions of the relevant compartments; and
- .4 *any other cargo transport unit*: at least on both sides and on the back of the unit.

###### 5.3.1.1.5 *Special provisions for class 7*

###### 5.3.1.1.5.1 Large freight containers carrying packages other than excepted packages, and tanks, shall bear four placards which conform with the model No. 7D given in the figure. The placards shall be affixed in a vertical orientation to each side wall and each end wall of the large freight container or tank. Any placards which do not relate to the contents shall be removed. Instead of using both labels and placards, it is permitted as an alternative to use enlarged labels only, as shown in label model Nos. 7A, 7B and 7C, and where appropriate 7E, with dimensions as required for the placard in the figure.

5.3.1.1.5.2 Rail and road vehicles carrying packages, overpacks or freight containers labelled with any of the labels shown in 5.2.2.2.2 as models Nos. 7A, 7B, 7C or 7E, or carrying consignments under exclusive use, shall display the placard shown in the figure (model No. 7D) on each of:

- .1 the two external lateral walls, in the case of a rail vehicle;
- .2 the two external lateral walls and the external rear wall, in the case of a road vehicle.

In the case of a vehicle without sides, the placards may be affixed directly on the cargo-carrying unit provided that they are readily visible; in the case of physically large tanks or freight containers, the placards on the tanks or freight containers shall suffice. In the case of vehicles which have insufficient area to allow the fixing of larger placards, the dimensions of the placard as described in the figure may be reduced to 100 mm. Any placards which do not relate to the contents shall be removed.

### 5.3.1.2 Specifications for placards

5.3.1.2.1 Except as provided in 5.3.1.2.2 for the class 7 placard, a placard shall:

- .1 be not less than 250 mm by 250 mm, with a line running 12.5 mm inside the edge and parallel with it. In the upper half of the placard the line shall have the same colour as the symbol and in the lower half it shall have the same colour as the figure in the bottom corner;
- .2 correspond to the label for the class of the dangerous goods in question with respect to colour and symbol; and
- .3 display the number of the class or division (and, for goods in class 1, the compatibility group letter) of the dangerous goods in question in the manner prescribed in 5.2.2.2 for the corresponding label, in digits not less than 25 mm high.

5.3.1.2.2 For class 7, the placard shall have minimum overall dimensions of 250 mm by 250 mm (except as permitted by 5.3.1.1.5.2) with a black line running 5 mm inside the edge and parallel with it, and shall be otherwise as shown in the figure below. When different dimensions are used, the relative proportions shall be maintained. The number "7" shall not be less than 25 mm high. The background colour of the upper half of the placard shall be yellow and of the lower half white; the colour of the trefoil and the printing shall be black. The use of the word "RADIOACTIVE" in the bottom half is optional to allow the use of this placard to display the appropriate United Nations Number for the consignment.

Placard for radioactive material of class 7

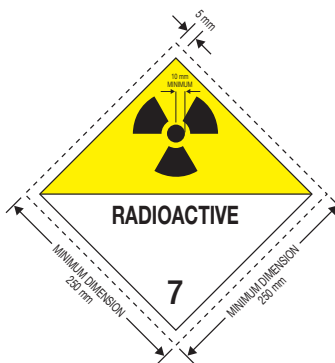

(No. 7D)

Symbol (trefoil): black.

Background: upper half yellow with white border, lower half white.

The lower half shall show the word **RADIOACTIVE** or alternatively, when required (see 5.3.2.1), the appropriate UN Number and the figure '7' in the bottom corner.

### 5.3.2 Marking of cargo transport units

#### 5.3.2.0 Display of Proper Shipping Name

5.3.2.0.1 The Proper Shipping Name of the contents shall be durably marked on at least both sides of:

- .1 tank transport units containing dangerous goods;

Part 5 – Consignment procedures

- .2 bulk containers containing dangerous goods; or
  - .3 any other cargo transport unit containing packaged dangerous goods of a single commodity for which no placard, UN Number or marine pollutant mark is required. Alternatively, the UN Number may be displayed.
- 5.3.2.0.2 The Proper Shipping Name for the goods shall be displayed in characters not less than 65 mm high. The Proper Shipping Name shall be of contrasting colour with the background.
- 5.3.2.1 **Display of UN Numbers**
- 5.3.2.1.1 Except for goods of class 1, the UN Number shall be displayed as required by this chapter on consignments of:
- .1 solids, liquids or gases transported in tank cargo transport units, including on each compartment of a multi-compartment tank cargo transport unit;
  - .2 packaged dangerous goods loaded in excess of 4000 kg gross mass, to which only one UN Number has been assigned and which are the only dangerous goods in the cargo transport unit;
  - .3 unpackaged LSA-I or SCO-I material of class 7 in or on a vehicle, or in a freight container, or in a tank;
  - .4 packaged radioactive material with a single UN Number in or on a vehicle, or in a freight container, when required to be transported under exclusive use;
  - .5 solid dangerous goods in bulk containers.
- 5.3.2.1.2 The UN Number for the goods shall be displayed in black digits not less than 65 mm high, either:
- .1 against a white background in the area below the pictorial symbol and above the class number and the compatibility group letter in a manner that does not obscure or detract from the other required label elements (see 5.3.2.1.3); or
  - .2 on an orange rectangular panel not less than 120 mm high and 300 mm wide, with a 10 mm black border, to be placed immediately adjacent to each placard or marine pollutant mark (see 5.3.2.1.3). When no placard or marine pollutant mark is required, the UN Number shall be displayed immediately adjacent to the Proper Shipping Name.
- 5.3.2.1.3 *Examples of display of UN Numbers*

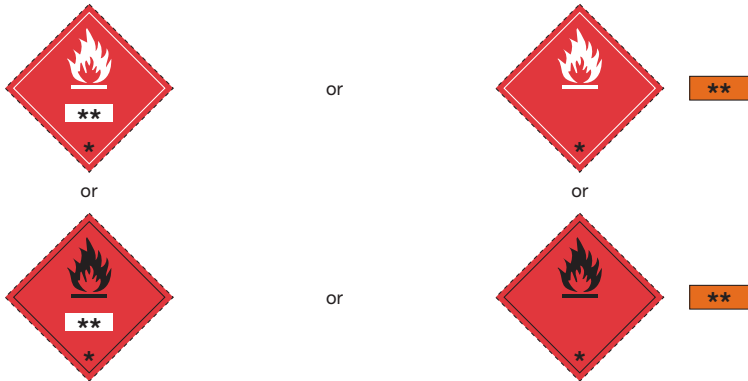

\* location of class or division number  
\*\* location of UN Number

- 5.3.2.2 **Elevated temperature substances**
- 5.3.2.2.1 Cargo transport units containing a substance that is transported or offered for transport in a liquid state at a temperature equal to or exceeding 100°C or in a solid state at a temperature equal to or exceeding 240°C shall bear on each side and on each end the mark shown in the figure. The triangular shaped mark shall have sides of at least 250 mm and shall be shown in red.

Mark for transport at elevated temperature



**5.3.2.2.2** In addition to the elevated temperature mark, the maximum temperature of the substance expected to be reached during transport shall be durably marked on both sides of the portable tank or insulation jacket, immediately adjacent to the elevated temperature mark, in characters at least 100 mm high.

**5.3.2.3 Marine pollutant mark**

Cargo transport units containing marine pollutants shall clearly display the marine pollutant mark in locations indicated in 5.3.1.1.4.1, even if the cargo transport unit contains packages not required to bear the marine pollutant mark. The mark shall conform to the specifications given in 5.2.1.6.3, and shall have minimum dimensions of 250 mm × 250 mm.

**5.3.2.4 Limited quantities**

Cargo transport units containing dangerous goods packed in limited quantities shall be placarded and marked according to 3.4.5.5.

## Chapter 5.4

---

### *Documentation*

- Note 1** The provisions of this Code do not preclude the use of electronic data processing (EDP) and electronic data interchange (EDI) transmission techniques as an alternative to paper documentation. All references to “dangerous goods transport document” in this chapter also include provision of the required information by use of EDP and EDI transmission techniques.
- Note 2** When dangerous goods are offered for transport, similar documents to those required for other categories of goods have to be prepared. The form of these documents, the particulars to be entered on them and the obligations they entail may be fixed by international conventions applying to certain modes of transport and by national legislation.
- Note 3** One of the primary requirements of a transport document for dangerous goods is to convey the fundamental information relative to the hazards of the goods. It is, therefore, necessary to include certain basic information on the document for a consignment of dangerous goods unless otherwise exempted or required in this Code.
- Note 4** In addition to the provisions of this chapter, other elements of information may be required by the competent authority.
- Note 5** In addition to the provisions of this chapter other additional information may be included. However, this information shall not:
- .1 divert attention from the safety information required by this chapter or by the competent authority;
  - .2 contradict the safety information required by this chapter or by the competent authority; or
  - .3 duplicate information already provided.

#### **5.4.1 Dangerous goods transport information**

##### **5.4.1.1 General**

- 5.4.1.1.1** Except as otherwise provided, the consignor who offers dangerous goods for transport shall give to the carrier the information applicable to those dangerous goods, including any additional information and documentation as specified in this Code. This information may be provided on a dangerous goods transport document or, with the agreement of the carrier, by EDP or EDI techniques.
- 5.4.1.1.2** When the dangerous goods transport information is given to the carrier by EDP or EDI techniques, the consignor shall be able to produce the information without delay as a paper document, with the information in the sequence required by this chapter.

##### **5.4.1.2 Form of the transport document**

- 5.4.1.2.1** A dangerous goods transport document may be in any form, provided it contains all of the information required by the provisions of this Code.
- 5.4.1.2.2** If both dangerous and non-dangerous goods are listed in one document, the dangerous goods shall be listed first, or otherwise be emphasized.

##### **5.4.1.2.3 Continuation page**

A dangerous goods transport document may consist of more than one page, provided pages are consecutively numbered.

- 5.4.1.2.4** The information on a dangerous goods transport document shall be easy to identify, legible and durable.



**5.4.1.2.5 Example of a dangerous goods transport document**

The form shown in figure 5.4.5 is an example of a dangerous goods transport document.\*

**5.4.1.3 Consignor, consignee and date**

The name and address of the consignor and the consignee of the dangerous goods shall be included on the dangerous goods transport document. The date the dangerous goods transport document or an electronic copy of it was prepared or given to the initial carrier shall be included.

**5.4.1.4 Information required on the dangerous goods transport document**

**5.4.1.4.1 Dangerous goods description**

The dangerous goods transport document shall contain the following information for each dangerous substance, material or article offered for transport:

- 1 The UN Number preceded by the letters "UN";
- 2 The Proper Shipping Name, as determined according to 3.1.2, including the technical name enclosed in parenthesis, as applicable (see 3.1.2.8);
- 3 The primary hazard class or, when assigned, the division of the goods, including, for class 1, the compatibility group letter. The words "Class" or "Division" may be included preceding the primary hazard class or division numbers;
- 4 Subsidiary hazard class or division number(s) corresponding to the subsidiary risk label(s) required to be applied, when assigned, shall be entered following the primary hazard class or division and shall be enclosed in parenthesis. The words "Class" or "Division" may be included preceding the subsidiary hazard class or division numbers;
- 5 Where assigned, the packing group for the substance or article, which may be preceded by "PG" (e.g. "PG II").

**5.4.1.4.2 Sequence of the dangerous goods description**

The five elements of the dangerous goods description specified in 5.4.1.4.1 shall be shown in the order listed above (i.e. .1, .2, .3, .4, and .5) with no information interspersed, except as provided in this Code. Unless permitted or required by this Code, additional information shall be placed after the dangerous goods description.

**5.4.1.4.3 Information which supplements the Proper Shipping Name in the dangerous goods description**

The Proper Shipping Name (see 3.1.2) in the dangerous goods description shall be supplemented as follows:

- 1 *Technical names for "n.o.s." and other generic descriptions:* Proper Shipping Names that are assigned special provision 274 or 318 in column 6 of the Dangerous Goods List shall be supplemented with their technical or chemical group names as described in 3.1.2.8;
- 2 *Empty uncleaned packagings, bulk containers and tanks:* Empty means of containment (including packagings, IBCs, bulk containers, portable tanks, road tank vehicles and railway tank wagons) which contain the residue of dangerous goods of classes other than class 7 shall be described as such by, for example, placing the words "EMPTY UNCLEANED" or "RESIDUE LAST CONTAINED" before or after the dangerous goods description specified in 5.4.1.4.1.1 to .5;
- 3 *Wastes:* For waste dangerous goods (other than radioactive wastes) which are being transported for disposal, or for processing for disposal, the Proper Shipping Name shall be preceded by the word "WASTE", unless this is already a part of the Proper Shipping Name;
- 4 *Elevated temperature substances:* If the Proper Shipping Name of a substance which is transported or offered for transport in a liquid state at a temperature equal to or exceeding 100°C, or in a solid state at a temperature equal to or exceeding 240°C, does not convey the elevated temperature condition (for example, by using the term "MOLTEN" or "ELEVATED TEMPERATURE" as part of the Proper Shipping Name), the word "HOT" shall immediately precede the Proper Shipping Name.

\* For standardized formats, see also the relevant recommendations of the UNECE United Nations Centre for Trade Facilitation and Electronic Business (UN/CEFACT), in particular Recommendation No. 1 (United Nations Layout Key for Trade Documents) (ECE/TRADE/137, edition 81.3), UN Layout Key for Trade Documents – Guidelines for Applications (ECE/TRADE/270, edition 2002), Revised Recommendation No. 11 (Documentary Aspects of the International Transport of Dangerous Goods) (ECE/TRADE/C/CEFACT/2008/8) and Recommendation No. 22 (Layout Key for Standard Consignment Instructions) (ECE/TRADE/168, edition 1989). Refer also to the UN/CEFACT Summary of Trade Facilitation Recommendations (ECE/TRADE/346, edition 2006) and the United Nations Trade Data Elements Directory (UNTDDED) (ECE/TRADE/362, edition 2005).



- 5.4.1.5.5.2 When organic peroxides and self-reactive substances are transported under conditions where approval is required (for organic peroxides, see 2.5.3.2.5, 4.1.7.2.2, 4.2.1.13.1 and 4.2.1.13.3; for self-reactive substances, see 2.4.2.3.2.4 and 4.1.7.2.2), a statement to this effect shall be included in the dangerous goods transport document. A copy of the classification approval and conditions of transport for non-listed organic peroxides and self-reactive substances shall be attached to the dangerous goods transport document.
- 5.4.1.5.5.3 When a sample of an organic peroxide (see 2.5.3.2.5.1) or a self-reactive substance (see 2.4.2.3.2.4.2) is transported, a statement to this effect shall be included in the dangerous goods transport document.
- 5.4.1.5.6 *Infectious substances*
- The full address of the consignee shall be shown on the document, together with the name of a responsible person and his telephone number.
- 5.4.1.5.7 *Radioactive material*
- 5.4.1.5.7.1 The following information shall be included for each consignment of class 7 material, as applicable, in the order given:
- .1 The name or symbol of each radionuclide or, for mixtures of radionuclides, an appropriate general description or a list of the most restrictive nuclides;
  - .2 A description of the physical and chemical form of the material, or a notation that the material is special form radioactive material or low dispersible radioactive material. A generic chemical description is acceptable for chemical form;
  - .3 The maximum activity of the radioactive contents during transport expressed in units of becquerels (Bq) with an appropriate SI prefix symbol (see 1.2.2.1). For fissile material, the mass of fissile material (or mass of each fissile nuclide for mixtures when appropriate) in units of grams (g), or appropriate multiples thereof, may be used in place of activity;
  - .4 The category of the package, i.e. I – WHITE, II – YELLOW, III – YELLOW;
  - .5 The transport index (categories II – YELLOW and III – YELLOW only);
  - .6 For consignments including fissile material other than consignments excepted under 6.4.11.2, the criticality safety index;
  - .7 The identification mark for each competent authority approval certificate (special form radioactive material, low dispersible radioactive material, special arrangement, package design, or shipment) applicable to the consignment;
  - .8 For consignments of more than one package, the information contained in 5.4.1.4.1.1 to .3 and 5.4.1.5.7.1.1 to .7 shall be given for each package. For packages in an overpack, freight container, or conveyance, a detailed statement of the contents of each package within the overpack, freight container, or conveyance and, where appropriate, of each overpack, freight container, or conveyance shall be included. If packages are to be removed from the overpack, freight container, or conveyance at a point of intermediate unloading, appropriate transport documents shall be made available;
  - .9 Where a consignment is required to be shipped under exclusive use, the statement “EXCLUSIVE USE SHIPMENT”; and
  - .10 For LSA-II, LSA-III, SCO-I and SCO-II, the total activity of the consignment as a multiple of  $A_2$ . For radioactive material for which the  $A_2$  value is unlimited, the multiple of  $A_2$  shall be zero.
- 5.4.1.5.7.2 The transport document shall include a statement regarding actions, if any, that are required to be taken by the carrier. The statement shall be in the languages deemed necessary by the carrier or the authorities concerned, and shall include at least the following points:
- .1 Supplementary requirements for loading, stowage, transport, handling and unloading of the package, overpack or freight container, including any special stowage provisions for the safe dissipation of heat (see 7.1.4.5.2), or a statement that no such requirements are necessary;
  - .2 Restrictions on the mode of transport or conveyance and any necessary routing instructions;
  - .3 Emergency arrangements appropriate to the consignment.
- 5.4.1.5.7.3 In all cases of international transport of packages requiring competent authorities design or shipment approval, for which different approval types apply in the different countries concerned by the shipment, the UN Number and Proper Shipping Name required in 5.4.1.4.1 shall be in accordance with the certificate of the country of origin of design.
- 5.4.1.5.7.4 The applicable competent authority certificates need not necessarily accompany the consignment. The consignor shall make them available to the carrier(s) before loading and unloading.

**Part 5 – Consignment procedures**

---

**5.4.1.5.8 Aerosols**

If the capacity of an aerosol is above 1000 ml, this shall be declared in the transport document.

**5.4.1.5.9 Explosives**

The following information shall be included for each consignment of class 1 goods, as applicable:

- .1 Entries have been included for “SUBSTANCES, EXPLOSIVE, N.O.S.”, “ARTICLES, EXPLOSIVE, N.O.S.”, and “COMPONENTS, EXPLOSIVE TRAIN, N.O.S.”. When a specific entry does not exist, the competent authority of the country of origin shall use the entry appropriate to the hazard division and compatibility group. The transport document shall contain the statement: “Transport under this entry approved by the competent authority of ...” followed by the State’s distinguishing sign for motor vehicles in international traffic of the country of the competent authority.
- .2 The transport of explosive substances for which a minimum water or phlegmatizer content is specified in the individual entry is prohibited when containing less water or phlegmatizer than the specified minimum. Such substances shall only be transported with special authorization granted by the competent authority of the country of origin. The transport document shall contain the statement “Transport under this entry approved by the competent authority of ...” followed by the State’s distinguishing sign for motor vehicles in international traffic of the country of the competent authority.
- .3 When explosive substances or articles are packaged “as approved by the competent authority”, the transport document shall contain the statement “Packaging approved by the competent authority of ...” followed by the State’s distinguishing sign for motor vehicles in international traffic of the country of the competent authority.
- .4 There are some hazards which are not indicated by the hazard division and compatibility group of a substance. The shipper shall provide an indication of any such hazards on the dangerous goods documentation.

**5.4.1.5.10 Viscous substances**

When viscous substances are transported in accordance with 2.3.2.5, the following statement shall be included in the transport document: “Transport in accordance with 2.3.2.5 of the IMDG Code.”.

**5.4.1.5.11 Special provisions for segregation**

- 5.4.1.5.11.1** For substances, mixtures, solutions or preparations classified under N.O.S. entries not included in the segregation groups listed in 3.1.4.4 but belonging, in the opinion of the consignor, to one of these groups (see 3.1.4.2), the appropriate segregation group name preceded by the phrase “IMDG Code segregation group” shall be included in the transport document after the dangerous goods description. For example:

“UN 1760 CORROSIVE LIQUID, N.O.S. (Phosphoric acid, acetic acid) 8 III IMDG Code segregation group 1 – Acids”.

- 5.4.1.5.11.2** When substances are loaded together in a cargo transport unit in accordance with 7.2.6.3, the following statement shall be included in the transport document: “Transport in accordance with 7.2.6.3 of the IMDG Code”.

- 5.4.1.5.11.3** When acid and alkali substances of class 8 are transported in the same cargo transport unit, whether in the same packaging or not, in accordance with 7.2.6.4, the following statement shall be included in the transport document: “Transport in accordance with 7.2.6.4 of the IMDG Code”.

**5.4.1.5.12 Transport of solid dangerous goods in bulk containers**

For bulk containers other than freight containers, the following statement shall be included on the transport document (see 6.9.4.6):

“Bulk container BK2 approved by the competent authority of ...”

**5.4.1.5.13 Transport of IBCs or portable tanks after the date of expiry of the last periodic test or inspection**

For transport in accordance with 4.1.2.2.2.2, 6.7.2.19.6.2, 6.7.3.15.6.2 or 6.7.4.14.6.2, a statement to this effect shall be included in the transport document, as follows: “Transport in accordance with 4.1.2.2.2.2”, “Transport in accordance with 6.7.2.19.6.2”, “Transport in accordance with 6.7.3.15.6.2” or “Transport in accordance with 6.7.4.14.6.2” as appropriate.

**5.4.1.5.14 Dangerous goods in excepted quantities**

- 5.4.1.5.14.1** When dangerous goods are transported according to the exceptions for dangerous goods packed in excepted quantities provided for in column 7b of the Dangerous Goods List and chapter 3.5, the words “dangerous goods in excepted quantities” shall be included.

#### 5.4.1.5.15 *Firework classification reference*

When fireworks of UN Nos. 0333, 0334, 0335, 0336 and 0337 are transported, the dangerous goods transport document shall include a classification reference(s) issued by the competent authority.

The classification reference(s) shall consist of the competent authority's state, indicated by the distinguishing sign for motor vehicles in international traffic, the competent authority identification and a unique serial reference. Examples of such classification references are:

- GB/HSE123456
- D/BAM1234
- USA EX20091234.

#### 5.4.1.6 Certification

5.4.1.6.1 The dangerous goods transport document shall include a certification or declaration that the consignment is acceptable for transport and that the goods are properly packaged, marked and labelled, and in proper condition for transport in accordance with the applicable regulations. The text for this certification is:

"I hereby declare that the contents of this consignment are fully and accurately described above by the Proper Shipping Name, and are classified, packaged, marked and labelled/placarded, and are in all respects in proper condition for transport according to applicable international and national government regulations."

The certification shall be signed and dated by the consignor. Facsimile signatures are acceptable where applicable laws and regulations recognize the legal validity of facsimile signatures.

5.4.1.6.2 If the dangerous goods documentation is presented to the carrier by means of EDP or EDI transmission techniques, the signature(s) may be electronic signature(s) or may be replaced by the name(s) (in capitals) of the person authorized to sign.

5.4.1.6.3 When the dangerous goods transport information is given to a carrier by EDP or EDI techniques and subsequently the dangerous goods are transferred to a carrier that requires a paper dangerous goods transport document, the carrier shall ensure that the paper document indicates "Original received electronically" and the name of the signatory shall be shown in capital letters.

### 5.4.2 Container/vehicle packing certificate

5.4.2.1 When dangerous goods are packed or loaded into any container\* or vehicle, those responsible for packing the container or vehicle shall provide a "container/vehicle packing certificate" specifying the container/vehicle identification number(s) and certifying that the operation has been carried out in accordance with the following conditions:

- .1 The container/vehicle was clean, dry and apparently fit to receive the goods;
- .2 Packages which need to be segregated in accordance with applicable segregation requirements have not been packed together onto or in the container/vehicle (unless approved by the competent authority concerned in accordance with 7.3.4.1);
- .3 All packages have been externally inspected for damage, and only sound packages have been loaded;
- .4 Drums have been stowed in an upright position, unless otherwise authorized by the competent authority, and all goods have been properly loaded and, where necessary, adequately braced with securing material to suit the mode(s)<sup>†</sup> of transport for the intended journey;
- .5 Goods loaded in bulk have been evenly distributed within the container/vehicle;
- .6 For consignments including goods of class 1 other than division 1.4, the container/vehicle is structurally serviceable in accordance with 7.1.2;
- .7 The container/vehicle and packages are properly marked, labelled and placarded, as appropriate;
- .8 When solid carbon dioxide (CO<sub>2</sub> – dry ice) is used for cooling purposes, the container/vehicle is externally marked in accordance with 5.5.3.6; and
- .9 A dangerous goods transport document, as indicated in 5.4.1, has been received for each dangerous goods consignment loaded in the container/vehicle.

**Note:** The container/vehicle packing certificate is not required for portable tanks.

\* See definition of "freight container" in 1.2.1.

† See IMO/ILO/UNECE Guidelines for packing of cargo transport units.

Part 5 – Consignment procedures

---

5.4.2.2 The information required in the dangerous goods transport document and the container/vehicle packing certificate may be incorporated into a single document; if not, these documents shall be attached one to the other. If the information is incorporated into a single document, the document shall include a signed declaration such as "It is declared that the packing of the goods into the container/vehicle has been carried out in accordance with the applicable provisions". This declaration shall be dated and the person signing this declaration shall be identified on the document. Facsimile signatures are acceptable where applicable laws and regulations recognize the legal validity of facsimile signatures.

5.4.2.3 If the container/vehicle packing certificate is presented to the carrier by means of EDP or EDI transmission techniques, the signature(s) may be electronic signature(s) or may be replaced by the name(s) (in capitals) of the person authorized to sign.

5.4.2.4 When the container/vehicle packing certificate is given to a carrier by EDP or EDI techniques and subsequently the dangerous goods are transferred to a carrier that requires a paper dangerous goods transport document, the carrier shall ensure that the paper document indicates "Original received electronically" and the name of the signatory shall be shown in capital letters.

### 5.4.3 Documentation required aboard the ship

5.4.3.1 Each ship carrying dangerous goods and marine pollutants shall have a special list, manifest or stowage plan setting out, in accordance with regulation VII/ 4.2 of SOLAS 1974, as amended, and with regulation 4.2 of Annex III of MARPOL 73/78, the dangerous goods and marine pollutants and the location thereof. This special list or manifest shall be based on the documentation and certification required in this Code. It shall contain in addition to the information in 5.4.1.4, 5.4.1.5 and, for UN 3359, in 5.5.2.4.1.1, the stowage location and the total quantity of dangerous goods and marine pollutants. A detailed stowage plan, which identifies by class and sets out the location of all dangerous goods and marine pollutants, may be used in place of such special list or manifest. A copy of one of these documents shall be made available before departure to the person or organization designated by the port State authority.

#### 5.4.3.2 Emergency response information

5.4.3.2.1 For consignments of dangerous goods, appropriate information shall be immediately available at all times for use in emergency response to accidents and incidents involving dangerous goods in transport. The information shall be available away from packages containing the dangerous goods and immediately accessible in the event of an incident. Methods of compliance include:

- .1 appropriate entries in the special list, manifest or dangerous goods declaration; or
- .2 provision of a separate document such as a safety data sheet; or
- .3 provision of separate documentation, such as the *Emergency Response Procedures for Ships Carrying Dangerous Goods (EmS Guide)* for use in conjunction with the transport document and the *Medical First Aid Guide for Use in Accidents Involving Dangerous Goods (MFAG)*.

### 5.4.4 Other required information and documentation

5.4.4.1 In certain circumstances, special certificates or other documents are required such as:

- .1 a weathering certificate; as required in the individual entries of the Dangerous Goods List;
- .2 a certificate exempting a substance, material or article from the provisions of the IMDG Code (such as, see individual entries for charcoal, fishmeal, seedcake);
- .3 for new self-reactive substances and organic peroxides or new formulation of currently assigned self-reactive substances and organic peroxides, a statement by the competent authority of the country of origin of the approved classification and conditions of transport.

### 5.4.5 Multimodal Dangerous Goods Form

5.4.5.1 This form meets the requirements of SOLAS 74, chapter VII, regulation 4, MARPOL 73/78, Annex III, regulation 4 and the provisions of this chapter. The information required by the provisions of this chapter is mandatory; however, the layout of this form is not mandatory.

**MULTIMODAL DANGEROUS GOODS FORM**

This form may be used as a dangerous goods declaration as it meets the requirements of SOLAS 74, chapter VII, regulation 4; MARPOL 73/78, Annex III, regulation 4.

1 Shipper/Consignor/Sender		2 Transport document number		
		3 Page 1 of      pages	4 Shipper's reference	
			5 Freight forwarder's reference	
6 Consignee		7 Carrier (to be completed by the carrier)		
		<b>SHIPPER'S DECLARATION</b> I hereby declare that the contents of this consignment are fully and accurately described below by the Proper Shipping Name, and are classified, packaged, marked and labelled/placarded and are in all respects in proper condition for transport according to the applicable international and national governmental regulations.		
8 This shipment is within the limitations prescribed for: (Delete non-applicable)		9 Additional handling information		
PASSENGER AND CARGO AIRCRAFT		CARGO AIRCRAFT ONLY		
10 Vessel/flight No. and date	11 Port/place of loading			
12 Port/place of discharge	13 Destination			
14 Shipping marks	* Number and kind of packages; description of goods	Gross mass (kg)	Net mass (kg)	Cube (m <sup>3</sup> )
15 Container identification No./ vehicle registration No.	16 Seal number(s)	17 Container/vehicle size & type	18 Tare mass (kg)	19 Total gross mass (including tare) (kg)
<b>CONTAINER/VEHICLE PACKING CERTIFICATE</b> I hereby declare that the goods described above have been packed/loaded into the container/vehicle identified above in accordance with the applicable provisions. <sup>†</sup> <b>MUST BE COMPLETED AND SIGNED FOR ALL CONTAINER/VEHICLE LOADS BY PERSON RESPONSIBLE FOR PACKING/LOADING</b>		<b>21 RECEIVING ORGANISATION RECEIPT</b> Received the above number of packages/containers/trailers in apparent good order and condition, unless stated hereon: RECEIVING ORGANISATION REMARKS:		
20 Name of company		Haulier's name	22 Name of company (OF SHIPPER PREPARING THIS NOTE)	
		Vehicle reg. no.		
Name/status of declarant		Signature and date	Name/status of declarant	
Place and date			Place and date	
Signature of declarant		DRIVER'S SIGNATURE	Signature of declarant	

<sup>†</sup> **DANGEROUS GOODS:**  
 You must specify: UN No., Proper Shipping Name, hazard class, packing group, (where assigned) marine pollutant and observe the mandatory requirements under applicable national and international governmental regulations. For the purposes of the IMDG Code, see 5.4.1.4.

<sup>†</sup> For the purposes of the IMDG Code, see 5.4.2.

Documentary Aspects of the International Transport of Dangerous Goods  
Container/Vehicle Packing Certificate

The signature given overleaf in Box 20 must be that of the person controlling the container/vehicle operation.

It is certified that:

The container/vehicle was clean, dry and apparently fit to receive the goods.

If the consignments include goods of class 1, other than division 1.4, the container is structurally serviceable.

No incompatible goods have been packed into the container/vehicle unless specially authorized by the Competent Authority.

All packages have been externally inspected for damage and only sound packages packed.

Drums have been stowed in an upright position unless otherwise authorized by the Competent Authority.

All packages have been properly packed and secured in the container/vehicle.

When materials are transported in bulk packagings, the cargo has been evenly distributed in the container/vehicle.

The packages and the container/vehicle have been properly marked, labelled and placarded. Any irrelevant mark, labels and placards have been removed.

When solid carbon dioxide (CO<sub>2</sub> – dry ice) is used for cooling purposes, the vehicle or freight container is externally marked in accordance with 5.5.3.6.

When this Dangerous Goods Form is used as a container/vehicle packing certificate only, not a combined document, a dangerous goods declaration signed by the shipper or supplier must have been issued/received to cover each dangerous goods consignment packed in the container.

**Note:** The container packing certificate is not required for tanks.



1 Shipper/Consignor/Sender	2 Transport document number			
	3 Page	of	pages	4 Shipper's reference
				5 Freight forwarder's reference
14 Shipping marks	* Number and kind of packages; description of goods	Gross mass (kg)	Net mass (kg)	Cube (m <sup>3</sup> )

**5.4.6 Retention of dangerous goods transport information**

- 5.4.6.1 The consignor and the carrier shall retain a copy of the dangerous goods transport document and additional information and documentation as specified in this Code, for a minimum period of three months.
- 5.4.6.2 When the documents are kept electronically or in a computer system, the consignor and the carrier shall be able to reproduce them in a printed form.

## Chapter 5.5

### *Special provisions*

5.5.1 [Reserved]

#### 5.5.2 Special provisions applicable to fumigated cargo transport units (UN 3359)

##### 5.5.2.1 General

5.5.2.1.1 Fumigated cargo transport units (UN 3359) containing no other dangerous goods are not subject to any provisions of this Code other than those of this section.

5.5.2.1.2 When the fumigated cargo transport unit is loaded with dangerous goods in addition to the fumigant, any provision of this Code relevant to these goods (including placarding, marking and documentation) applies in addition to the provisions of this section.

5.5.2.1.3 Only cargo transport units that can be closed in such a way that the escape of gas is reduced to a minimum shall be used for the transport of cargo under fumigation.

5.5.2.1.4 The provisions of 3.2 and 5.4.3 apply to all fumigated cargo transport units (UN 3359).

##### 5.5.2.2 Training

Persons engaged in the handling of fumigated cargo transport units shall be trained commensurate with their responsibilities.

##### 5.5.2.3 Marking and placarding

5.5.2.3.1 A fumigated cargo transport unit shall be marked with a warning mark, as specified in 5.5.2.3.2, affixed at each access point in a location where it will be easily seen by persons opening or entering the cargo transport unit. This mark shall remain on the cargo transport unit until the following provisions are met:

- (a) The fumigated cargo transport unit has been ventilated to remove harmful concentrations of fumigant gas; and
- (b) The fumigated goods or materials have been unloaded.

5.5.2.3.2 The fumigation warning mark shall be rectangular and shall not be less than 300 mm wide and 250 mm high. The markings shall be in black print on a white background with lettering not less than 25 mm high. An illustration of this mark is given below.

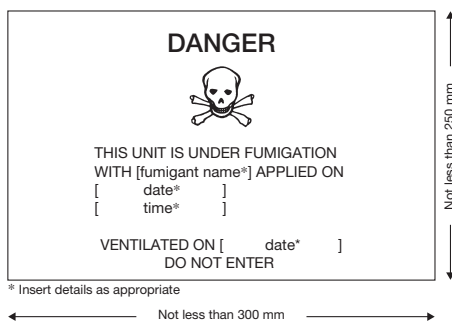

## Part 5 – Consignment procedures

- 5.5.2.3.3 If the fumigated cargo transport unit has been completely ventilated either by opening the doors of the unit or by mechanical ventilation after fumigation, the date of ventilation shall be marked on the fumigation warning mark.
- 5.5.2.3.4 When the fumigated cargo transport unit has been ventilated and unloaded, the fumigation warning mark shall be removed.
- 5.5.2.3.5 Class 9 placards (Model No.9, see 5.2.2.2.2) shall not be affixed to a fumigated cargo transport unit except as required for other class 9 substances or articles packed therein.
- 5.5.2.4 **Documentation**
- 5.5.2.4.1 Documents associated with the transport of cargo transport units that have been fumigated and have not been completely ventilated before transport shall include the following information:
- .1 UN 3359, fumigated cargo transport unit, 9, or UN 3359, fumigated cargo transport unit, class 9;
  - .2 The date and time of fumigation; and
  - .3 The type and amount of the fumigant used.
- 5.5.2.4.2 The transport document may be in any form, provided it contains the information required in 5.5.2.4.1. This information shall be easy to identify, legible and durable.
- 5.5.2.4.3 Instructions for disposal of any residual fumigant including fumigation devices (if used) shall be provided.
- 5.5.2.4.4 A document is not required when the fumigated cargo transport unit has been completely ventilated and the date of ventilation has been marked on the warning mark (see 5.5.2.3.3 and 5.5.2.3.4).
- 5.5.2.5 **Additional provisions**
- 5.5.2.5.1 Cargo transport units shall be fumigated and handled taking into account the provisions of the MSC.1/Circ.1361 on Revised Recommendations on the safe use of pesticides in ships applicable to the fumigation of cargo transport units.
- 5.5.2.5.2 When fumigated cargo transport units are stowed under deck, equipment for detecting fumigant gas(es) shall be carried on the ship with instructions for their use.
- 5.5.2.5.3 Fumigants shall not be applied to the contents of a cargo transport unit once it has been loaded aboard the ship.
- 5.5.2.5.4 A fumigated cargo transport unit shall not be allowed on board until a sufficient period has elapsed to attain a reasonable uniform gas concentration throughout the cargo in it. Because of variations due to types and amounts of fumigants and commodities and temperature levels, the period between fumigant application and loading of the fumigated cargo transport unit on board the ship shall be determined by the competent authority. Twenty-four hours is normally sufficient for this purpose. Unless the doors of a fumigated cargo transport unit have been opened to allow the fumigant gas(es) and residues to be completely ventilated or the unit has been mechanically ventilated, the shipment shall conform to the provisions of this Code concerning UN 3359. Ventilated cargo transport units shall be marked with the date of ventilation on the fumigation warning mark. When the fumigated goods or materials have been unloaded, the fumigation warning mark shall be removed.
- 5.5.2.5.5 The master shall be informed prior to the loading of a fumigated cargo transport unit.
- 5.5.3 **Special provisions applicable to packages and cargo transport units containing substances presenting a risk of asphyxiation when used for cooling or conditioning purposes (such as dry ice (UN 1845) or nitrogen, refrigerated liquid (UN 1977) or argon, refrigerated liquid (UN 1951))**
- Note: See also 1.1.1.7.
- 5.5.3.1 **Scope**
- 5.5.3.1.1 This section is not applicable to substances which may be used for cooling or conditioning purposes when transported as a consignment of dangerous goods. When they are transported as a consignment, these substances shall be transported under the relevant entry of the Dangerous Goods List in Chapter 3.2 in accordance with the associated conditions of transport.
- 5.5.3.1.2 This section is not applicable to gases in cooling cycles.
- 5.5.3.1.3 Dangerous goods used for cooling or conditioning portable tanks or MEGCs during transport are not subject to this section.

**5.5.3.2 General**

5.5.3.2.1 Cargo transport units containing substances used for cooling or conditioning purposes (other than fumigation) during transport are not subject to any provisions of this Code other than those of this section.

5.5.3.2.2 When dangerous goods are loaded in cooled or conditioned cargo transport units any provisions of this Code relevant to these dangerous goods apply in addition to the provisions of this section. For dangerous goods for which temperature control is required see also 7.3.7.

5.5.3.2.3 Reserved.

5.5.3.2.4 Persons engaged in the handling or transport of cooled or conditioned cargo transport units shall be trained commensurate with their responsibilities.

5.5.3.3 Packages containing a coolant or conditioner

5.5.3.3.1 Packaged dangerous goods requiring cooling or conditioning assigned to packing instructions P203, P620, P650, P800, P901 or P904 of 4.1.4.1 shall meet the appropriate requirements of that packing instruction.

5.5.3.3.2 For packaged dangerous goods requiring cooling or conditioning assigned to other packing instructions, the packages shall be capable of withstanding very low temperatures and shall not be affected or significantly weakened by the coolant or conditioner. Packages shall be designed and constructed to permit the release of gas to prevent a build-up of pressure that could rupture the packaging. The dangerous goods shall be packed in such a way to prevent movement after the dissipation of any coolant or conditioner.

5.5.3.3.3 Packages containing a coolant or conditioner shall be transported in well ventilated cargo transport units.

**5.5.3.4 Marking of packages containing a coolant or conditioner**

5.5.3.4.1 Packages containing dangerous goods used for cooling or conditioning shall be marked with the proper shipping name of these dangerous goods followed by the words "AS COOLANT" or "AS CONDITIONER" as appropriate.

5.5.3.4.2 The markings shall be durable, legible and placed in such a location and of such a size relative to the package as to be readily visible.

**5.5.3.5 Cargo transport units containing unpackaged dry ice**

5.5.3.5.1 If dry ice in unpackaged form is used, it shall not come into direct contact with the metal structure of a cargo transport unit to avoid embrittlement of the metal. Measures shall be taken to provide adequate insulation between the dry ice and the cargo transport unit by providing a minimum of 30 mm separation (e.g., by using suitable low heat conducting materials such as timber planks, pallets, etc.).

5.5.3.5.2 Where dry ice is placed around packages, measures shall be taken to ensure that packages remain in the original position during transport after the dry ice has dissipated.

**5.5.3.6 Marking of cargo transport units**

5.5.3.6.1 Cargo transport units containing dangerous goods used for cooling or conditioning shall be marked with a warning mark, as specified in 5.5.3.6.2 affixed at each access point in a location where it will be easily seen by persons opening or entering the cargo transport unit. This mark shall remain on the cargo transport unit until the following provisions are met:

- .1 The cargo transport unit has been ventilated to remove harmful concentrations of coolant or conditioner; and
- .2 The cooled or conditioned goods have been unloaded.

5.5.3.6.2 The warning mark shall be rectangular and shall not be less than 150 mm wide and 250 mm high. The warning mark shall include:

- .1 The word "WARNING" in red or white with lettering not less than 25 mm high; and
- .2 The proper shipping name followed by the words "AS COOLANT" or "AS CONDITIONER" as appropriate, shown below the symbol in black letters on a white background with lettering not less than 25 mm high.

For example: CARBON DIOXIDE, SOLID, AS COOLANT.

An illustration of this mark is given in Figure 5.5.2.

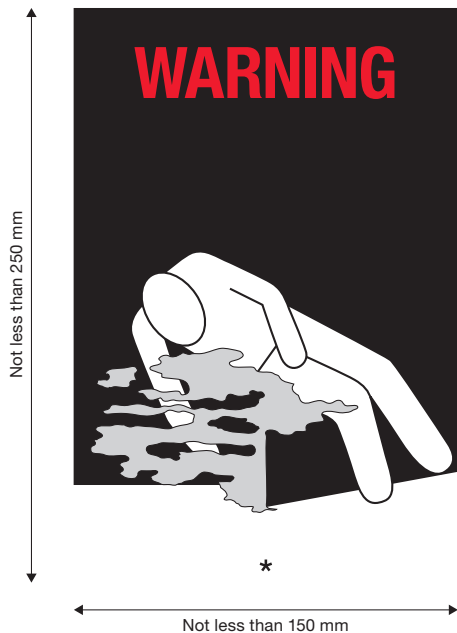

\* insert the proper shipping name followed by the words "AS COOLANT" or "AS CONDITIONER" as appropriate.

Figure 5.5.2

5.5.3.7 Documentation

5.5.3.7.1 Documents associated with the transport of cargo transport units that have been cooled or conditioned and have not been completely ventilated before transport shall include the following information:

- .1 The UN number preceded by the letters "UN"; and
- .2 The proper shipping name followed by the words "AS COOLANT" or "AS CONDITIONER" as appropriate.

For example: UN 1845, CARBON DIOXIDE, SOLID, AS COOLANT".

5.5.3.7.2 The transport document may be in any form, provided it contains the information required in 5.5.3.7.1. This information shall be easy to identify, legible and durable.

## **PART 6**

CONSTRUCTION AND TESTING OF PACKAGINGS,  
INTERMEDIATE BULK CONTAINERS (IBCs),  
LARGE PACKAGINGS, PORTABLE TANKS,  
MULTIPLE-ELEMENT GAS CONTAINERS (MEGCs)  
AND ROAD TANK VEHICLES





## Chapter 6.1

### *Provisions for the construction and testing of packagings (other than for class 6.2 substances)*

#### 6.1.1 Applicability and general provisions

##### 6.1.1.1 Applicability

The provisions in this chapter do not apply to:

- .1 pressure receptacles;
- .2 packages containing radioactive material, which shall comply with the Regulations of the International Atomic Energy Agency (IAEA), except that:
  - (i) radioactive material possessing other dangerous properties (subsidiary risks) shall also comply with special provision 172 in chapter 3.3; and
  - (ii) low specific activity (LSA) material and surface contaminated objects (SCO) may be carried in certain packagings defined in this Code provided that the supplementary provisions set out in the IAEA Regulations are also met;
- .3 packages whose net mass exceeds 400 kg; and
- .4 packages with a capacity exceeding 450 ℓ.

##### 6.1.1.2 General provisions

6.1.1.2.1 The provisions for packagings in 6.1.4 are based on packagings currently used. In order to take into account progress in science and technology, there is no objection to the use of packagings having specifications different from those in 6.1.4, provided that they are equally effective, acceptable to the competent authority and able successfully to withstand the tests described in 6.1.1.2 and 6.1.5. Methods of testing other than those described in this chapter are acceptable, provided that they are equivalent.

6.1.1.2.2 Every packaging intended to contain liquids shall successfully undergo a suitable leakproofness test and be capable of meeting the appropriate test level indicated in 6.1.5.4.4:

- .1 before it is first used for transport;
- .2 after remanufacturing or reconditioning, before it is re-used for transport.

For this test, packagings need not have their own closures fitted.

The inner receptacle of a composite packaging may be tested without the outer packaging provided the test results are not affected. This test is not necessary for an inner packaging of a combination packaging.

6.1.1.2.3 Receptacles, parts of receptacles and closures (stoppers) made of plastics which may be directly in contact with a dangerous substance shall be resistant to it and shall not incorporate materials which may react dangerously or form hazardous compounds or lead to softening, weakening or failure of the receptacle or closure.

6.1.1.2.4 Plastics packagings shall be adequately resistant to ageing and to degradation caused either by the substance contained or by ultraviolet radiation. Any permeation of the substance contained shall not constitute a danger under normal conditions of transport.

6.1.1.3 Packagings shall be manufactured, reconditioned and tested under a quality-assurance programme which satisfies the competent authority in order to ensure that each packaging meets the provisions of this chapter.

**Note:** ISO 16106:2006 "Packaging – Transport packages for dangerous goods – Dangerous goods packagings, intermediate bulk containers (IBCs) and large packagings – Guidelines for the application of ISO 9001" provides acceptable guidance on procedures which may be followed.

6.1.1.4 Manufacturers and subsequent distributors of packagings shall provide information regarding procedures to be followed and a description of the types and dimensions of closures (including required gaskets) and any other components needed to ensure that packages as presented for transport are capable of passing the applicable performance tests of this chapter.

**6.1.2 Code for designating types of packagings**

6.1.2.1 The code consists of:

- .1 an Arabic numeral indicating the kind of packaging, such as drum, jerrican, etc., followed by
- .2 one or more capital letters in Latin characters indicating the nature of the material, such as steel, wood, etc., followed where necessary by
- .3 an Arabic numeral indicating the category of packaging within the type to which the packaging belongs.

6.1.2.2 In the case of composite packagings, two capital letters in Latin characters shall be used in sequence in the second position of the code. The first indicates the material of the inner receptacle and the second that of the outer packaging.

6.1.2.3 In the case of combination packagings, only the code number for the outer packaging shall be used.

6.1.2.4 The letters 'T', 'V' or 'W' may follow the packaging code. The letter 'T' signifies a salvage packaging conforming to the provisions of 6.1.5.1.11. The letter 'V' signifies a special packaging conforming to the provisions of 6.1.5.1.7. The letter 'W' signifies that the packaging, although of the same type as that indicated by the code, is manufactured to a specification different to that in 6.1.4 but is considered equivalent under the provisions of 6.1.1.2.

6.1.2.5 The following numerals shall be used for the kinds of packaging:

- 1 Drum
- 2 [Reserved]
- 3 Jerrican
- 4 Box
- 5 Bag
- 6 Composite packaging

6.1.2.6 The following capital letters shall be used for the types of material:

- A Steel (all types and surface treatments)
- B Aluminium
- C Natural wood
- D Plywood
- F Reconstituted wood
- G Fibreboard
- H Plastics material
- L Textile
- M Paper, multiwall
- N Metal (other than steel or aluminium)
- P Glass, porcelain or stoneware

**Note:** "Plastics material" is taken to include other polymeric materials such as rubber.

6.1.2.7 The following table indicates the codes to be used for designating types of packagings depending on the kind of packagings, the material used for their construction and their category; it also refers to the paragraphs to be consulted for the appropriate provisions:

Kind	Material	Category	Code	Paragraph
1 Drums	A Steel	non-removable head	1A1	6.1.4.1
		removable head	1A2	
	B Aluminium	non-removable head	1B1	6.1.4.2
		removable head	1B2	
	D Plywood	–	1D	6.1.4.5
	G Fibre	–	1G	6.1.4.7
	H Plastics	non-removable head	1H1	6.1.4.8
		removable head	1H2	
	N Metal, other than steel or aluminium	non-removable head	1N1	6.1.4.3
		removable head	1N2	
2 [Reserved]				

**Chapter 6.1 – Provisions for the construction and testing of packagings**

Kind	Material	Category	Code	Paragraph
3 Jerricans	A Steel	non-removable head	3A1	6.1.4.4
		removable head	3A2	
	B Aluminium	non-removable head	3B1	6.1.4.4
		removable head	3B2	
	H Plastics	non-removable head	3H1	6.1.4.8
		removable head	3H2	
4 Boxes	A Steel	–	4A	6.1.4.14
	B Aluminium	–	4B	6.1.4.14
	C Natural wood	ordinary	4C1	6.1.4.9
		with sift-proof walls	4C2	
	D Plywood	–	4D	6.1.4.10
	F Reconstituted wood	–	4F	6.1.4.11
	G Fibreboard	–	4G	6.1.4.12
		–	4G	
	H Plastics	expanded	4H1	6.1.4.13
solid		4H2		
N Metal, other than steel or aluminium	–	4N	6.1.4.14	
5 Bags	H Woven plastics	without inner lining or coating	5H1	6.1.4.16
		sift-proof	5H2	
		water-resistant	5H3	
	H Plastics film	–	5H4	6.1.4.17
	L Textile	without inner lining or coating	5L1	6.1.4.15
		sift-proof	5L2	
		water-resistant	5L3	
	M Paper	multiwall	5M1	6.1.4.18
		multiwall, water-resistant	5M2	
6 Composite packagings	H Plastics receptacle	in steel drum	6HA1	6.1.4.19
		in steel crate or box	6HA2	6.1.4.19
		in aluminium drum	6HB1	6.1.4.19
		in aluminium crate or box	6HB2	6.1.4.19
		in wooden box	6HC	6.1.4.19
		in plywood drum	6HD1	6.1.4.19
		in plywood box	6HD2	6.1.4.19
		in fibre drum	6HG1	6.1.4.19
		in fibreboard box	6HG2	6.1.4.19
		in plastics drum	6HH1	6.1.4.19
		in solid plastics box	6HH2	6.1.4.19
	P Glass, porcelain or stoneware receptacle	in steel drum	6PA1	6.1.4.20
		in steel crate or box	6PA2	6.1.4.20
		in aluminium drum	6PB1	6.1.4.20
		in aluminium crate or box	6PB2	6.1.4.20
		in wooden box	6PC	6.1.4.20
		in plywood drum	6PD1	6.1.4.20
		in wickerwork hamper	6PD2	6.1.4.20
		in fibre drum	6PG1	6.1.4.20
		in fibreboard box	6PG2	6.1.4.20
		in expanded plastics packaging	6PH1	6.1.4.20
in solid plastics packaging	6PH2	6.1.4.20		

### 6.1.3 Marking

**Note 1:** The marking indicates that the packaging which bears it corresponds to a successfully tested design type and that it complies with the provisions of this chapter which are related to the manufacture, but not to the use, of the packaging. In itself, therefore, the mark does not necessarily confirm that the packaging may be used for any substance. The type of packaging (such as steel drum), its maximum capacity or mass, and any special provisions are specified for each substance or article in part 3 of this Code.

**Note 2:** The marking is intended to be of assistance to packaging manufacturers, reconditioners, packaging users, carriers and regulatory authorities. In relation to the use of a new packaging, the original marking is a means for its manufacturer to identify the type and to indicate those performance test provisions that have been met.

**Note 3:** The marking does not always provide full details of the test levels, etc., and these may need to be taken further into account, such as by reference to a test certificate, test reports or register of successfully tested packagings. For example, a packaging having an X or Y marking may be used for substances to which a packing group having a lesser degree of danger has been assigned, with the relevant maximum permissible value of the relative density\* determined by taking into account the factor 1.5 or 2.25 indicated in the packaging test provisions in 6.1.5 as appropriate, i.e., packing group I packaging tested for products of relative density 1.2 could be used as a packing group II packaging for products of relative density 1.8 or packing group III packaging of relative density 2.7, provided, of course, that all the performance criteria can still be met with the product having the higher relative density.

6.1.3.1 Each packaging intended for use according to this Code shall bear markings which are durable, legible and placed in such a location and of such a size relative to the packaging as to be readily visible. For packages with a gross mass of more than 30 kg, the markings or a duplicate thereof shall appear on the top or on a side of the packaging. Letters, numerals and symbols shall be at least 12 mm high, except for packagings of 30 ℓ or 30 kg capacity or less, when they shall be at least 6 mm in height, and for packagings of 5 ℓ or 5 kg or less, when they shall be of an appropriate size.

The marking shall show:

- (a) The United Nations packaging symbol



This symbol shall not be used for any purpose other than certifying that a packaging, a flexible bulk container, a portable tank or a MEGC complies with the relevant requirements in Chapter 6.1, 6.2, 6.3, 6.5, 6.6, 6.7 or 6.9. For embossed metal packagings the capital letters “UN” may be applied as the symbol.

- (b) The code designating the type of packaging according to 6.1.2.
- (c) A code in two parts:
- (i) a letter designating the packing group or groups for which the design type has been successfully tested:
    - “X” for packing groups I, II and III
    - “Y” for packing groups II and III
    - “Z” for packing group III only;
  - (ii) the relative density, rounded off to the first decimal, for which the design type has been tested for packagings, without inner packagings, intended to contain liquids; this may be omitted when the relative density does not exceed 1.2. For packagings intended to contain solids or inner packagings, the maximum gross mass in kilograms.
- (d) Either a letter “S”, denoting that the packaging is intended for the transport of solids or inner packagings, or, for packagings (other than combination packagings) intended to contain liquids, the hydraulic test pressure which the packaging was shown to withstand in kilopascals, rounded down to the nearest 10 kPa.

---

\* Relative density (d) is considered to be synonymous with specific gravity (SG) and will be used throughout this text.

- (e) The last two digits of the year during which the packaging was manufactured. Packagings of types 1H and 3H shall also be appropriately marked with the month of manufacture; this may be marked on the packaging in a different place from the remainder of the marking. An appropriate method is:

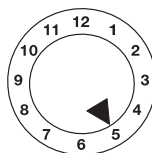

- (f) The State authorizing the allocation of the mark, indicated by the distinguishing sign for motor vehicles in international traffic.
- (g) The name of the manufacturer or other identification of the packaging specified by the competent authority.

**6.1.3.2** In addition to the durable markings prescribed in 6.1.3.1, every new metal drum of a capacity greater than 100 ℓ shall bear the marks described in 6.1.3.1 (a) to (e) on the bottom, with an indication of the nominal thickness of at least the metal used in the body (in millimetres, to 0.1 mm), in permanent form (such as embossed). When the nominal thickness of either head of a metal drum is thinner than that of the body, the nominal thickness of the top head, body and bottom head shall be marked on the bottom in permanent form (such as embossed), for example '1.0 – 1.2 – 1.0' or '0.9 – 1.0 – 1.0'. Nominal thicknesses of metal shall be determined according to the appropriate ISO standard, for example ISO 3574:1999 for steel. The marks indicated in 6.1.3.1 (f) and (g) shall not be applied in a permanent form (such as embossed) except as provided in 6.1.3.5.

**6.1.3.3** Every packaging other than those referred to in 6.1.3.2 liable to undergo a reconditioning process shall bear the marks indicated in 6.1.3.1 (a) to (e) in a permanent form. Marks are permanent if they are able to withstand the reconditioning process (e.g., embossed). For packagings other than metal drums of a capacity greater than 100 ℓ, these permanent marks may replace the corresponding durable markings prescribed in 6.1.3.1.

**6.1.3.4** For remanufactured metal drums, if there is no change to the packaging type and no replacement or removal of integral structural components, the required markings need not be permanent (such as embossed). Every other remanufactured metal drum shall bear the markings in 6.1.3.1 (a) to (e) in a permanent form (such as embossed) on the top head or side.

**6.1.3.5** Metal drums made from materials (such as stainless steel) designed to be re-used repeatedly may bear the markings indicated in 6.1.3.1 (f) and (g) in a permanent (such as embossed) form.

**6.1.3.6** Packagings manufactured with recycled plastics material as defined in 1.2.1 shall be marked "REC". This mark shall be placed near the mark prescribed in 6.1.3.1.

**6.1.3.7** Marking shall be applied in the sequence of the subparagraphs in 6.1.3.1; each element of the marking required in these subparagraphs and when appropriate subparagraphs (h) to (j) of 6.1.3.8 shall be clearly separated, e.g., by a slash or space, so as to be easily identifiable. For examples, see 6.1.3.10. Any additional markings authorized by a competent authority shall still enable the parts of the mark to be correctly identified with reference to 6.1.3.1.

**6.1.3.8** After reconditioning a packaging, the reconditioner shall apply to it, in the following sequence, a durable marking showing:

- (h) the State in which the reconditioning was carried out, indicated by the distinguishing sign for motor vehicles in international traffic;
- (i) the name of the reconditioner or other identification of the packaging specified by the competent authority;
- (j) the year of reconditioning; the letter "R"; and, for every packaging successfully passing the leakproofness test in 6.1.1.2.2, the additional letter "L".

**6.1.3.9** When, after reconditioning, the markings required by 6.1.3.1 (a) to (d) no longer appear on the top head or the side of a metal drum, the reconditioner shall apply them in a durable form followed by those required by 6.1.3.8 (h), (i) and (j). These markings shall not identify a greater performance capability than that for which the original design type has been tested and marked.

Part 6 – Construction and testing of packagings, IBCs, etc.

6.1.3.10 Examples of markings for NEW packagings



4G/Y145/S/02  
NL/VL823

as in 6.1.3.1 (a), (b), (c), (d) and (e)  
as in 6.1.3.1 (f) and (g)

For a new fibreboard box



1A1/Y1.4/150/98  
NL/VL824

as in 6.1.3.1 (a), (b), (c), (d) and (e)  
as in 6.1.3.1 (f) and (g)

For a new steel drum to contain liquids



1A2/Y150/S/01  
NL/VL825

as in 6.1.3.1 (a), (b), (c), (d) and (e)  
as in 6.1.3.1 (f) and (g)

For a new steel drum to contain solids or inner packagings



4HW/Y136/S/98  
NL/VL826

as in 6.1.3.1 (a), (b), (c), (d) and (e)  
as in 6.1.3.1 (f) and (g)

For a new plastics box of a specification equivalent to that indicated by the packaging code



1A2/Y/100/01  
USA/MM5

as in 6.1.3.1 (a), (b), (c), (d) and (e)  
as in 6.1.3.1 (f) and (g)

For a remanufactured steel drum to contain liquids of relative density not exceeding 1.2

**Note:** For liquids, the marking of relative density not exceeding 1.2 is optional; see 6.1.3.1 (c)(ii)

6.1.3.11 Examples of markings for RECONDITIONED packagings



1A1/Y1.4/150/97  
NL/RB/01 RL

as in 6.1.3.1 (a), (b), (c), (d) and (e)  
as in 6.1.3.8 (h), (i) and (j)



1A2/Y150/S/99  
USA/RB/00 R

as in 6.1.3.1 (a), (b), (c), (d) and (e)  
as in 6.1.3.8 (h), (i) and (j)

6.1.3.12 Examples of markings for SALVAGE packagings



1A2T/Y300/S/01  
USA/abc

as in 6.1.3.1 (a), (b), (c), (d) and (e)  
as in 6.1.3.1 (f) and (g)

**Note:** The markings, for which examples are given in 6.1.3.10, 6.1.3.11 and 6.1.3.12, may be applied in a single line or in multiple lines provided the correct sequence is respected.

6.1.4 Provisions for packagings

6.1.4.0 General provisions

Any permeation of the substance contained in the packaging shall not constitute a danger under normal conditions of transport.

6.1.4.1 Steel drums

- 1A1 non-removable head
- 1A2 removable head

- 6.1.4.1.1 Body and heads shall be constructed of steel sheet of suitable type and adequate thickness in relation to the capacity of the drum and the intended use.
- Note:** For carbon steel drums, “suitable” steels are identified in ISO 3573:1999 “Hot rolled carbon steel sheet of commercial and drawing qualities” and ISO 3574:1999 “Cold-reduced carbon steel sheet of commercial and drawing qualities”.
- For carbon steel drums below 100 litres, “suitable” steels in addition to the above standards are also identified in ISO 11949:1995 “Cold-reduced electrolytic tinplate”, ISO 11950:1995 “Cold-reduced electrolytic chromium/chromium oxide-coated steel” and ISO 11951:1995 “Cold-reduced blackplate in coil form for the production of tinplate or electrolytic chromium/chromium-oxide coated steel”.
- 6.1.4.1.2 Body seams of drums intended to contain more than 40 ℓ of liquid shall be welded. Body seams of drums intended to contain solids or 40 ℓ or less of liquids shall be mechanically seamed or welded.
- 6.1.4.1.3 Chimes shall be mechanically seamed or welded. Separate reinforcing rings may be applied.
- 6.1.4.1.4 The body of a drum of a capacity greater than 60 ℓ shall, in general, have at least two expanded rolling hoops or, alternatively, at least two separate rolling hoops. If there are separate rolling hoops, they shall be fitted tightly on the body and so secured that they cannot shift. Rolling hoops shall not be spot-welded.
- 6.1.4.1.5 Openings for filling, emptying and venting in the bodies or heads of drums with a non-removable head (1A1) shall not exceed 7 cm in diameter. Drums with larger openings are considered to be of the removable-head type (1A2). Closures for openings in the bodies and heads of drums shall be so designed and applied that they will remain secure and leakproof under normal conditions of transport. Closure flanges may be mechanically seamed or welded in place. Gaskets or other sealing elements shall be used with closures, unless the closure is inherently leakproof.
- 6.1.4.1.6 Closure devices for removable-head drums shall be so designed and applied that they will remain secure and drums will remain leakproof under normal conditions of transport. Gaskets or other sealing elements shall be used with all removable heads.
- 6.1.4.1.7 If materials used for body, heads, closures and fittings are not in themselves compatible with the contents to be transported, suitable internal protective coatings or treatments shall be applied. These coatings or treatments shall retain their properties under normal conditions of transport.
- 6.1.4.1.8 Maximum capacity of drum: 450 ℓ.
- 6.1.4.1.9 Maximum net mass: 400 kg.
- 6.1.4.2 **Aluminium drums**
- 1B1 non-removable head
- 1B2 removable head
- 6.1.4.2.1 Body and heads shall be constructed of aluminium at least 99% pure or of an aluminium-based alloy. Material shall be of a suitable type and of adequate thickness in relation to the capacity of the drum and the intended use.
- 6.1.4.2.2 All seams shall be welded. Chime seams, if any, shall be reinforced by the application of separate reinforcing rings.
- 6.1.4.2.3 The body of a drum of a capacity greater than 60 ℓ shall, in general, have at least two expanded rolling hoops or, alternatively, at least two separate rolling hoops. If there are separate rolling hoops, they shall be fitted tightly on the body and so secured that they cannot shift. Rolling hoops shall not be spot-welded.
- 6.1.4.2.4 Openings for filling, emptying and venting in the bodies or heads of drums with a non-removable head (1B1) shall not exceed 7 cm in diameter. Drums with larger openings are considered to be of the removable-head type (1B2). Closures for openings in the bodies and heads of drums shall be so designed and applied that they will remain secure and leakproof under normal conditions of transport. Closure flanges shall be welded in place so that the weld provides a leakproof seam. Gaskets or other sealing elements shall be used with closures, unless the closure is inherently leakproof.
- 6.1.4.2.5 Closure devices for removable-head drums shall be so designed and applied that they will remain secure and drums will remain leakproof under normal conditions of transport. Gaskets or other sealing elements shall be used with all removable heads.
- 6.1.4.2.6 Maximum capacity of drum: 450 ℓ.
- 6.1.4.2.7 Maximum net mass: 400 kg.
- 6.1.4.3 **Drums of metal other than aluminium or steel**
- 1N1 non-removable head
- 1N2 removable head

## Part 6 – Construction and testing of packagings, IBCs, etc.

- 6.1.4.3.1 The body and heads shall be constructed of metal or metal alloy other than steel or aluminium. Material shall be of a suitable type and of adequate thickness in relation to the capacity of the drum and to its intended use.
- 6.1.4.3.2 Chime seams, if any, shall be reinforced by the application of separate reinforcing rings. All seams, if any, shall be joined (welded, soldered, etc.) in accordance with the technical state of the art for the used metal or metal alloy.
- 6.1.4.3.3 The body of a drum of a capacity greater than 60 ℓ shall, in general, have at least two expanded rolling hoops or, alternatively, at least two separate rolling hoops. If there are separate rolling hoops, they shall be fitted tightly on the body and so secured that they cannot shift. Rolling hoops shall not be spot-welded.
- 6.1.4.3.4 Openings for filling, emptying and venting in the bodies or heads of non-removable-head (1N1) drums shall not exceed 7 cm in diameter. Drums with larger openings are considered to be of the removable-head type (1N2). Closures for openings in the bodies and heads of drums shall be so designed and applied that they will remain secure and leakproof under normal conditions of transport. Closure flanges shall be joined in place (welded, soldered, etc.) in accordance with the technical state of the art for the used metal or metal alloy so that the seam join is leakproof. Gaskets or other sealing elements shall be used with closures, unless the closure is inherently leakproof.
- 6.1.4.3.5 Closure devices for removable-head drums shall be so designed and applied that they will remain secure and drums will remain leakproof under normal conditions of transport. Gaskets or other sealing elements shall be used with all removable heads.
- 6.1.4.3.6 Maximum capacity of drum: 450 ℓ.
- 6.1.4.3.7 Maximum net mass: 400 kg.
- 6.1.4.4 **Steel or aluminium jerricans**
- 3A1 steel, non-removable head
  - 3A2 steel, removable head
  - 3B1 aluminium, non-removable head
  - 3B2 aluminium, removable head
- 6.1.4.4.1 Body and heads shall be constructed of steel sheet, of aluminium at least 99% pure or of an aluminium-based alloy. Material shall be of a suitable type and of adequate thickness in relation to the capacity of the jerrican and to its intended use.
- 6.1.4.4.2 Chimes of steel jerricans shall be mechanically seamed or welded. Body seams of steel jerricans intended to contain more than 40 ℓ of liquid shall be welded. Body seams of steel jerricans intended to contain 40 ℓ or less shall be mechanically seamed or welded. For aluminium jerricans, all seams shall be welded. Chime seams, if any, shall be reinforced by the application of a separate reinforcing ring.
- 6.1.4.4.3 Openings in jerricans (3A1 and 3B1) shall not exceed 7 cm in diameter. Jerricans with larger openings are considered to be of the removable-head type (3A2 and 3B2). Closures shall be so designed that they will remain secure and leakproof under normal conditions of transport. Gaskets or other sealing elements shall be used with closures, unless the closure is inherently leakproof.
- 6.1.4.4.4 If materials used for body, heads, closures and fittings are not in themselves compatible with the contents to be transported, suitable internal protective coatings or treatments shall be applied. These coatings or treatments shall retain their protective properties under normal conditions of transport.
- 6.1.4.4.5 Maximum capacity of jerrican: 60 ℓ.
- 6.1.4.4.6 Maximum net mass: 120 kg.
- 6.1.4.5 **Plywood drums**
- 1D
- 6.1.4.5.1 The wood used shall be well seasoned, commercially dry and free from any defect likely to lessen the effectiveness of the drum for the purpose intended. If a material other than plywood is used for the manufacture of the heads, it shall be of a quality equivalent to the plywood.
- 6.1.4.5.2 At least two-ply plywood shall be used for the body and at least three-ply plywood for the heads; the plies shall be firmly glued together by a water-resistant adhesive with their grain crosswise.
- 6.1.4.5.3 The body and heads of the drum and their joints shall be of a design appropriate to the capacity of the drum and its intended use.
- 6.1.4.5.4 In order to prevent sifting of the contents, lids shall be lined with kraft paper or some other equivalent material, which shall be securely fastened to the lid and extend to the outside along its full circumference.



- 6.1.4.5.5 Maximum capacity of drum: 250 ℓ.
- 6.1.4.5.6 Maximum net mass: 400 kg.
- 6.1.4.6 [Reserved]
- 6.1.4.7 **Fibre drums**  
1G
- 6.1.4.7.1 The body of the drum shall consist of multiple plies of heavy paper or fibreboard (without corrugations) firmly glued or laminated together and may include one or more protective layers of bitumen, waxed kraft paper, metal foil, plastics material, etc.
- 6.1.4.7.2 Heads shall be of natural wood, fibreboard, metal, plywood, plastics or other suitable material and may include one or more protective layers of bitumen, waxed kraft paper, metal foil, plastics material, etc.
- 6.1.4.7.3 The body and heads of the drum and their joints shall be of a design appropriate to the capacity of the drum and its intended use.
- 6.1.4.7.4 The assembled packaging shall be sufficiently water-resistant so as not to delaminate under normal conditions of transport.
- 6.1.4.7.5 Maximum capacity of drum: 450 ℓ.
- 6.1.4.7.6 Maximum net mass: 400 kg.
- 6.1.4.8 **Plastics drums and jerricans**  
1H1 drums, non-removable head  
1H2 drums, removable head  
3H1 jerricans, non-removable head  
3H2 jerricans, removable head
- 6.1.4.8.1 The packaging shall be manufactured from suitable plastics material and be of adequate strength in relation to its capacity and intended use. Except for *recycled plastics material* as defined in 1.2.1, no used material other than production residues or regrind from the same manufacturing process may be used. The packaging shall be adequately resistant to ageing and to degradation caused by the substance contained or by ultraviolet radiation.
- 6.1.4.8.2 If protection against ultraviolet radiation is required, it shall be provided by the addition of carbon black or other suitable pigments or inhibitors. These additives shall be compatible with the contents and remain effective throughout the life of the packaging. Where use is made of carbon black, pigments or inhibitors other than those used in the manufacture of the tested design type, retesting may be waived if the carbon black content does not exceed 2% by mass or if the pigment content does not exceed 3% by mass; the content of inhibitors of ultraviolet radiation is not limited.
- 6.1.4.8.3 Additives serving purposes other than protection against ultraviolet radiation may be included in the composition of the plastics material, provided that they do not adversely affect the chemical and physical properties of the material of the packaging. In such circumstances, retesting may be waived.
- 6.1.4.8.4 The wall thickness at every point of the packaging shall be appropriate to its capacity and intended use, taking into account the stresses to which each point is liable to be exposed.
- 6.1.4.8.5 Openings for filling, emptying and venting in the bodies or heads of non-removable-head drums (1H1) and jerricans (3H1) shall not exceed 7 cm in diameter. Drums and jerricans with larger openings are considered to be of the removable-head type (1H2 and 3H2). Closures for openings in the bodies or heads of drums and jerricans shall be so designed and applied that they will remain secure and leakproof under normal conditions of transport. Gaskets or other sealing elements shall be used with closures, unless the closure is inherently leakproof.
- 6.1.4.8.6 Closure devices for removable-head drums and jerricans shall be so designed and applied that they will remain secure and leakproof under normal conditions of transport. Gaskets shall be used with all removable heads unless the drum or jerrican design is such that, where the removable head is properly secured, the drum or jerrican is inherently leakproof.
- 6.1.4.8.7 Maximum capacity of drums and jerricans: 1H1, 1H2: 450 ℓ  
3H1, 3H2: 60 ℓ
- 6.1.4.8.8 Maximum net mass: 1H1, 1H2: 400 kg  
3H1, 3H2: 120 kg

## Part 6 – Construction and testing of packagings, IBCs, etc.

- 6.1.4.9 Boxes of natural wood**  
 4C1 ordinary  
 4C2 with sift-proof walls
- 6.1.4.9.1 The wood used shall be well seasoned, commercially dry and free from defects that would materially lessen the strength of any part of the box. The strength of the material used and the method of construction shall be appropriate to the capacity and intended use of the box. The tops and bottoms may be made of water-resistant reconstituted wood such as hardboard, particle board or other suitable type.
- 6.1.4.9.2 Fastenings shall be resistant to vibration experienced under normal conditions of transport. Nailing into the end shall be avoided whenever practicable. Joins which are likely to be highly stressed shall be made using clenched or annular ring nails or equivalent fastenings.
- 6.1.4.9.3 Box 4C2: each part shall consist of one piece or be equivalent thereto. Parts are considered equivalent to one piece when one of the following methods of glued assembly is used: Lindermann joint, tongue and groove joint, ship lap or rabbet joint or butt joint, all with at least two corrugated metal fasteners at each joint.
- 6.1.4.9.4 Maximum net mass: 400 kg.
- 6.1.4.10 Plywood boxes**  
 4D
- 6.1.4.10.1 Plywood used shall be at least three-ply. It shall be made from well-seasoned rotary-cut, sliced or sawn veneer, commercially dry and free from defects that would materially lessen the strength of the box. The strength of the material used and the method of construction shall be appropriate to the capacity and intended use of the box. All adjacent plies shall be glued with water-resistant adhesive. Other suitable materials may be used together with plywood in the construction of boxes. Boxes shall be firmly nailed or secured to corner posts or ends or be assembled by equally suitable devices.
- 6.1.4.10.2 Maximum net mass: 400 kg.
- 6.1.4.11 Reconstituted wood boxes**  
 4F
- 6.1.4.11.1 The walls of boxes shall be made of water-resistant reconstituted wood such as hardboard, particle board or other suitable type. The strength of the material used and the method of construction shall be appropriate to the capacity of the boxes and their intended use.
- 6.1.4.11.2 Other parts of the boxes may be made of other suitable material.
- 6.1.4.11.3 Boxes shall be securely assembled by means of suitable devices.
- 6.1.4.11.4 Maximum net mass: 400 kg.
- 6.1.4.12 Fibreboard boxes**  
 4G
- 6.1.4.12.1 Strong and good-quality solid or double-faced corrugated fibreboard (single or multiwall) shall be used, appropriate to the capacity of the box and to its intended use. The water resistance of the outer surface shall be such that the increase in mass, as determined in a test carried out over a period of 30 minutes by the Cobb method of determining water absorption, is not greater than 155 g/m<sup>2</sup> – see ISO 535:1991. It shall have proper bending qualities. Fibreboard shall be cut, creased without scoring, and slotted so as to permit assembly without cracking, surface breaks or undue bending. The fluting of corrugated fibreboard shall be firmly glued to the facings.
- 6.1.4.12.2 The ends of boxes may have a wooden frame or be entirely of wood or other suitable material. Reinforcements of wooden battens or other suitable material may be used.
- 6.1.4.12.3 Manufacturing joins in the body of boxes shall be taped, lapped and glued or lapped and stitched with metal staples. Lapped joins shall have an appropriate overlap.
- 6.1.4.12.4 Where closing is effected by gluing or taping, a water-resistant adhesive shall be used.
- 6.1.4.12.5 Boxes shall be designed so as to provide a good fit to the contents.
- 6.1.4.12.6 Maximum net mass: 400 kg.
- 6.1.4.13 Plastics boxes**  
 4H1 expanded plastics boxes  
 4H2 solid plastics boxes

- 6.1.4.13.1 The box shall be manufactured from suitable plastics material and be of adequate strength in relation to its capacity and intended use. The box shall be adequately resistant to ageing and to degradation caused either by the substance contained or by ultraviolet radiation.
- 6.1.4.13.2 An expanded plastics box shall comprise two parts made of a moulded expanded plastics material, a bottom section containing cavities for the inner packagings and a top section covering and interlocking with the bottom section. The top and bottom sections shall be designed so that the inner packagings fit snugly. The closure cap for any inner packaging shall not be in contact with the inside of the top section of this box.
- 6.1.4.13.3 For dispatch, an expanded plastics box shall be closed with a self-adhesive tape having sufficient tensile strength to prevent the box from opening. The adhesive tape shall be weather-resistant and its adhesive compatible with the expanded plastics material of the box. Other closing devices at least equally effective may be used.
- 6.1.4.13.4 For solid plastics boxes, protection against ultraviolet radiation, if required, shall be provided by the addition of carbon black or other suitable pigments or inhibitors. These additives shall be compatible with the contents and remain effective throughout the life of the box. Where use is made of carbon black, pigments or inhibitors other than those used in the manufacture of the tested design type, retesting may be waived if the carbon black content does not exceed 2% by mass or if the pigment content does not exceed 3% by mass; the content of inhibitors of ultraviolet radiation is not limited.
- 6.1.4.13.5 Additives serving purposes other than protection against ultraviolet radiation may be included in the composition of the plastics material provided that they do not adversely affect the chemical and physical properties of the material of the box. In such circumstances, retesting may be waived.
- 6.1.4.13.6 Solid plastics boxes shall have closure devices made of a suitable material of adequate strength and be so designed as to prevent the box from unintentional opening.
- 6.1.4.13.7 Maximum net mass: 4H1: 60 kg  
4H2: 400 kg
- 6.1.4.14 **Steel, aluminium or other metal boxes**
- 4A steel boxes
- 4B aluminium boxes
- 4N metal, other than steel or aluminium, boxes
- 6.1.4.14.1 The strength of the metal and the construction of the box shall be appropriate to the capacity of the box and to its intended use.
- 6.1.4.14.2 Boxes shall be lined with fibreboard or felt packing pieces or shall have an inner liner or coating of suitable material, as required. If a double-seamed metal liner is used, steps shall be taken to prevent the ingress of substances, particularly explosives, into the recesses of the seams.
- 6.1.4.14.3 Closures may be of any suitable type; they shall remain secured under normal conditions of transport.
- 6.1.4.14.4 Maximum net mass: 400 kg.
- 6.1.4.15 **Textile bags**
- 5L1 without inner lining or coating
- 5L2 sift-proof
- 5L3 water-resistant
- 6.1.4.15.1 The textiles used shall be of good quality. The strength of the fabric and the construction of the bag shall be appropriate to the capacity of the bag and its intended use.
- 6.1.4.15.2 Bags, sift-proof, 5L2: the bag shall be made sift-proof, for example by the use of:
- .1 paper bonded to the inner surface of the bag by a water-resistant adhesive such as bitumen; or
  - .2 plastics film bonded to the inner surface of the bag; or
  - .3 one or more inner liners made of paper or plastics material.
- 6.1.4.15.3 Bags, water-resistant, 5L3: to prevent the entry of moisture, the bag shall be made waterproof, for example by the use of:
- .1 separate inner liners of water-resistant paper (such as waxed kraft paper, tarred paper or plastics-coated kraft paper); or
  - .2 plastics film bonded to the inner surface of the bag; or
  - .3 one or more inner liners made of plastics material.

## Part 6 – Construction and testing of packagings, IBCs, etc.

- 6.1.4.15.4 Maximum net mass: 50 kg.
- 6.1.4.16 **Woven plastics bags**  
 5H1 without inner liner or coating  
 5H2 sift-proof  
 5H3 water-resistant
- 6.1.4.16.1 Bags shall be made from stretched tapes or monofilaments of a suitable plastics material. The strength of the material used and the construction of the bag shall be appropriate to the capacity of the bag and its intended use.
- 6.1.4.16.2 If the fabric is woven flat, the bags shall be made by sewing or some other method ensuring closure of the bottom and one side. If the fabric is tubular, the bag shall be closed by sewing, weaving or some other equally strong method of closure.
- 6.1.4.16.3 Bags, sift-proof, 5H2: the bag shall be made sift-proof, for example by means of:  
 .1 paper or a plastics film bonded to the inner surface of the bag; or  
 .2 one or more separate inner liners made of paper or plastics material.
- 6.1.4.16.4 Bags, water-resistant, 5H3: to prevent the entry of moisture, the bag shall be made waterproof, for example by means of:  
 .1 separate inner liners of water-resistant paper (such as waxed kraft paper, double-tarred kraft paper or plastics-coated kraft paper); or  
 .2 plastics film bonded to the inner or outer surface of the bag; or  
 .3 one or more inner plastics liners.
- 6.1.4.16.5 Maximum net mass: 50 kg.
- 6.1.4.17 **Plastics film bags**  
 5H4
- 6.1.4.17.1 Bags shall be made of a suitable plastics material. The strength of the material used and the construction of the bag shall be appropriate to the capacity of the bag and its intended use. Joins and closures shall withstand pressures and impacts liable to occur under normal conditions of transport.
- 6.1.4.17.2 Maximum net mass: 50 kg.
- 6.1.4.18 **Paper bags**  
 5M1 multiwall  
 5M2 multiwall, water-resistant
- 6.1.4.18.1 Bags shall be made of a suitable kraft paper or of an equivalent paper with at least three plies, the middle ply of which may be net-cloth with adhesive bonding to the outermost ply. The strength of the paper and the construction of the bags shall be appropriate to the capacity of the bag and its intended use. Joins and closures shall be sift-proof.
- 6.1.4.18.2 Bags 5M2: to prevent the entry of moisture, a bag of four plies or more shall be made waterproof by the use of either a water-resistant ply as one of the two outermost plies or a water-resistant barrier made of a suitable protective material between the two outermost plies; a bag of three plies shall be made waterproof by the use of a water-resistant ply as the outermost ply. Where there is a danger of the substance contained reacting with moisture or where it is packed damp, a waterproof ply or barrier, such as double-tarred kraft paper, plastics-coated kraft paper, plastics film bonded to the inner surface of the bag, or one or more inner plastics liners, shall also be placed next to the substance. Joins and closures shall be waterproof.
- 6.1.4.18.3 Maximum net mass: 50 kg.
- 6.1.4.19 **Composite packagings (plastics material)**  
 6HA1 plastics receptacle with outer steel drum  
 6HA2 plastics receptacle with outer steel crate or box  
 6HB1 plastics receptacle with outer aluminium drum  
 6HB2 plastics receptacle with outer aluminium crate or box  
 6HC plastics receptacle with outer wooden box  
 6HD1 plastics receptacle with outer plywood drum  
 6HD2 plastics receptacle with outer plywood box

6HG1	plastics receptacle with outer fibre drum
6HG2	plastics receptacle with outer fibreboard box
6HH1	plastics receptacle with outer plastics drum
6HH2	plastics receptacle with outer solid plastics box

**6.1.4.19.1 Inner receptacle**

- .1 The provisions of 6.1.4.8.1 and 6.1.4.8.3 to 6.1.4.8.6 shall apply to inner plastics receptacles.
- .2 The inner plastics receptacle shall fit snugly inside the outer packaging, which shall be free of any projection that might abrade the plastics material.
- .3 Maximum capacity of inner receptacle:

6HA1, 6HB1, 6HD1, 6HG1, 6HH1	250 ℓ
6HA2, 6HB2, 6HC, 6HD2, 6HG2, 6HH2	60 ℓ
- .4 Maximum net mass:

6HA1, 6HB1, 6HD1, 6HG1, 6HH1	400 kg
6HA2, 6HB2, 6HC, 6HD2, 6HG2, 6HH2	75 kg

**6.1.4.19.2 Outer packaging**

- .1 Plastics receptacle with outer steel or aluminium drum (6HA1 or 6HB1): the relevant provisions of 6.1.4.1 or 6.1.4.2, as appropriate, shall apply to the construction of the outer packaging.
- .2 Plastics receptacle with outer steel or aluminium crate or box (6HA2 or 6HB2): the relevant provisions of 6.1.4.14 shall apply to the construction of the outer packaging.
- .3 Plastics receptacle with outer wooden box 6HC: the relevant provisions of 6.1.4.9 shall apply to the construction of the outer packaging.
- .4 Plastics receptacle with outer plywood drum 6HD1: the relevant provisions of 6.1.4.5 shall apply to the construction of the outer packaging.
- .5 Plastics receptacle with outer plywood box 6HD2: the relevant provisions of 6.1.4.10 shall apply to the construction of the outer packaging.
- .6 Plastics receptacle with outer fibre drum 6HG1: the provisions of 6.1.4.7.1 to 6.1.4.7.4 shall apply to the construction of the outer packaging.
- .7 Plastics receptacle with outer fibreboard box 6HG2: the relevant provisions of 6.1.4.12 shall apply to the construction of the outer packaging.
- .8 Plastics receptacle with outer plastics drum 6HH1: the provisions of 6.1.4.8.1 and 6.1.4.8.2 to 6.1.4.8.6 shall apply to the construction of the outer packaging.
- .9 Plastics receptacle with outer solid plastics box (including corrugated plastics material) 6HH2: the provisions of 6.1.4.13.1 and 6.1.4.13.4 to 6.1.4.13.6 shall apply to the construction of the outer packaging.

**6.1.4.20 Composite packagings (glass, porcelain or stoneware)**

6PA1	receptacle with outer steel drum
6PA2	receptacle with outer steel crate or box
6PB1	receptacle with outer aluminium drum
6PB2	receptacle with outer aluminium crate or box
6PC	receptacle with outer wooden box
6PD1	receptacle with outer plywood drum
6PD2	receptacle with outer wickerwork hamper
6PG1	receptacle with outer fibre drum
6PG2	receptacle with outer fibreboard box
6PH1	receptacle with outer expanded plastics packaging
6PH2	receptacle with outer solid plastics packaging

**6.1.4.20.1 Inner receptacle**

- .1 Receptacles shall be of a suitable form (cylindrical or pear-shaped) and be made of good-quality material free from any defect that could impair their strength. The walls shall be sufficiently thick at every point.
- .2 Screw-threaded plastics closures, ground glass stoppers or closures at least equally effective shall be used as closures for receptacles. Any part of the closure likely to come into contact with the contents of the receptacle shall be resistant to those contents. Care shall be taken to ensure that the closures are so fitted as to be leakproof and are suitably secured to prevent any loosening during transport. If vented closures are necessary, they shall comply with 4.1.1.8.

- .3 The receptacle shall be firmly secured in the outer packaging by means of cushioning and/or absorbent materials.
- .4 Maximum capacity of receptacle: 60 ℓ.
- .5 Maximum net mass: 75 kg.

6.1.4.20.2 **Outer packaging**

- .1 Receptacle with outer steel drum 6PA1: the relevant provisions of 6.1.4.1 shall apply to the construction of the outer packaging. The removable lid required for this type of packaging may nevertheless be in the form of a cap.
- .2 Receptacle with outer steel crate or box 6PA2: the relevant provisions of 6.1.4.14 shall apply to the construction of the outer packaging. For cylindrical receptacles, the outer packaging shall, when upright, rise above the receptacle and its closure. If the crate surrounds a pear-shaped receptacle and is of matching shape, the outer packaging shall be fitted with a protective cover (cap).
- .3 Receptacle with outer aluminium drum 6PB1: the relevant provisions of 6.1.4.2 shall apply to the construction of the outer packaging.
- .4 Receptacle with outer aluminium crate or box 6PB2: the relevant provisions of 6.1.4.14 shall apply to the construction of the outer packaging.
- .5 Receptacle with outer wooden box 6PC: the relevant provisions of 6.1.4.9 shall apply to the construction of the outer packaging.
- .6 Receptacle with outer plywood drum 6PD1: the relevant provisions of 6.1.4.5 shall apply to the construction of the outer packaging.
- .7 Receptacle with outer wickerwork hamper 6PD2: the wickerwork hamper shall be properly made with material of good quality. It shall be fitted with a protective cover (cap) so as to prevent damage to the receptacle.
- .8 Receptacle with outer fibre drum 6PG1: the relevant provisions of 6.1.4.7.1 to 6.1.4.7.4 shall apply to the body of the outer packaging.
- .9 Receptacle with outer fibreboard box 6PG2: the relevant provisions of 6.1.4.12 shall apply to the construction of the outer packaging.
- .10 Receptacle with outer expanded plastics or solid plastics packaging (6PH1 or 6PH2): the materials of both outer packagings shall meet the relevant provisions of 6.1.4.13. Solid plastics packaging shall be manufactured from high-density polyethylene or some other comparable plastics material. The removable lid for this type of packaging may nevertheless be in the form of a cap.

6.1.5 **Test provisions for packagings**

6.1.5.1 **Performance and frequency of tests**

- 6.1.5.1.1 The design type of each packaging shall be tested as provided in this section, in accordance with procedures established by the competent authority.
- 6.1.5.1.2 Each packaging design type shall successfully pass the tests prescribed in this chapter before being used. A packaging design type is defined by the design, size, material and thickness, manner of construction and packing, but may include various surface treatments. It also includes packagings which differ from the design type only in their lesser design height.
- 6.1.5.1.3 Tests shall be repeated on production samples at intervals established by the competent authority. For such tests on paper or fibreboard packagings, preparation at ambient conditions is considered equivalent to the provisions of 6.1.5.2.3.
- 6.1.5.1.4 Tests shall also be repeated after each modification which alters the design, material or manner of construction of a packaging.
- 6.1.5.1.5 The competent authority may permit the selective testing of packagings that differ only in minor respects from a tested type, such as smaller sizes of inner packagings or inner packagings of lower net mass; and packagings such as drums, bags and boxes which are produced with small reductions in external dimensions.
- 6.1.5.1.6 [Reserved]

**Note:** For the conditions for assembling different inner packagings in an outer packaging and permissible variations in inner packagings, see 4.1.1.5.1.

- 6.1.5.1.7 Articles or inner packagings of any type for solids or liquids may be assembled and transported without testing in an outer packaging under the following conditions:
- .1 The outer packaging shall have been successfully tested in accordance with 6.1.5.3 with fragile (such as glass) inner packagings containing liquids, using the drop height for packing group I.
  - .2 The total combined gross mass of inner packagings shall not exceed one half the gross mass of inner packagings used for the drop test in .1 above.
  - .3 The thickness of the cushioning material between inner packagings and between inner packagings and the outside of the packaging shall not be reduced below the corresponding thicknesses in the originally tested packaging; and when a single inner packaging was used in the original test, the thicknesses of the cushioning between inner packagings shall not be less than the thickness of cushioning between the outside of the packaging and the inner packaging in the original test. When either fewer or smaller inner packagings are used (as compared to the inner packagings used in the drop test), sufficient additional cushioning material shall be used to take up void spaces.
  - .4 The outer packaging shall have successfully passed the stacking test in 6.1.5.6 while empty. The total mass of identical packages shall be based on the combined mass of inner packagings used in the drop test in .1 above.
  - .5 Inner packagings containing liquids shall be completely surrounded with a sufficient quantity of absorbent material to absorb the entire liquid contents of the inner packagings.
  - .6 When the outer packaging is intended to contain inner packagings for liquids and is not leakproof, or is intended to contain inner packagings for solids and is not sift-proof, a means of containing any liquid or solid contents in the event of leakage shall be provided in the form of a leakproof liner, plastics bag or other equally efficient means of containment. For packagings containing liquids, the absorbent material required in .5 above shall be placed inside the means of containing the liquid contents.
  - .7 Packagings shall be marked in accordance with section 6.1.3 as having been tested to packing group I performance for combination packagings. The marked gross mass, in kilograms, shall be the sum of the mass of the outer packaging plus one half of the mass of the inner packaging(s) as used for the drop test referred to in .1 above. Such a packaging mark shall also contain the letter 'V' as described in 6.1.2.4.
- 6.1.5.1.8 The competent authority may at any time require proof, by tests in accordance with this section, that serially produced packagings meet the provisions of the design type tests.
- 6.1.5.1.9 If an inner treatment or coating is required for safety reasons, it shall retain its protective properties after the tests.
- 6.1.5.1.10 Provided the validity of the test results is not affected, and with the approval of the competent authority, several tests may be made on one sample.
- 6.1.5.1.11 **Salvage packagings**
- 6.1.5.1.11.1 Salvage packagings (see 1.2.1) shall be tested and marked in accordance with the provisions applicable to packing group II packagings intended for the transport of solids or inner packagings, except as follows:
- .1 The test substance used in performing the tests shall be water and the packagings shall be filled to not less than 98% of their maximum capacity. It is permissible to use additives, such as bags of lead shot, to achieve the requisite total package mass so long as they are placed in such a way that the test results are not affected. Alternatively, in performing the drop test, the drop height may be varied in accordance with 6.1.5.3.5(b);
  - .2 Packagings shall, in addition, have been successfully subjected to the leakproofness test at 30 kPa, with the results of this test reflected in the test report required by 6.1.5.7; and
  - .3 Packagings shall be marked with the letter 'T' as described in 6.1.2.4.
- 6.1.5.2 **Preparation of packagings for testing**
- 6.1.5.2.1 Tests shall be carried out on packagings prepared as for transport, including, with respect to combination packagings, the inner packagings used. Inner or single receptacles or packagings, other than bags, shall be filled to not less than 98% of their maximum capacity for liquids or 95% for solids. Bags shall be filled to the maximum mass at which they may be used. For combination packagings where the inner packaging is designed to carry liquids and solids, separate testing is required for both solid and liquid contents. The substances or articles to be transported in the packagings may be replaced by other substances or articles except where this would invalidate the results of the tests. For solids, when another substance is used, it shall have the same physical characteristics (mass, grain size, etc.) as the substance to be carried. It is permissible to use additives, such as bags of lead shot, to achieve the requisite total package mass, so long as they are placed so that the test results are not affected.

Part 6 – Construction and testing of packagings, IBCs, etc.

6.1.5.2.2 In the drop tests for liquids, when another substance is used, it shall be of similar relative density and viscosity to those of the substance being transported. Water may also be used for the liquid drop test under the conditions in 6.1.5.3.5.

6.1.5.2.3 Paper or fibreboard packagings shall be conditioned for at least 24 hours in an atmosphere having controlled temperature and relative humidity (r.h.). There are three options, one of which shall be chosen. The preferred atmosphere is 23°C ± 2°C and 50% ± 2% r.h. The two other options are 20°C ± 2°C and 65% ± 2% r.h. or 27°C ± 2°C and 65% ± 2% r.h.

**Note:** Average values shall fall within these limits. Short-term fluctuations and measurement limitations may cause individual measurements to vary by up to ± 5% relative humidity without significant impairment of test reproducibility.

6.1.5.2.4 Additional steps shall be taken to ascertain that the plastics material used in the manufacture of plastics drums, plastics jerricans and composite packagings (plastics material) intended to contain liquids complies with the provisions in 6.1.1.2, 6.1.4.8.1 and 6.1.4.8.3. This may be done, for example, by submitting sample receptacles or packagings to a preliminary test extending over a long period, for example six months, during which the samples would remain filled with the substances they are intended to contain and after which the samples shall be submitted to the applicable tests listed in 6.1.5.3, 6.1.5.4, 6.1.5.5, and 6.1.5.6. For substances which may cause stress cracking or weakening in plastics drums or jerricans, the sample, filled with the substance or another substance that is known to have at least as severe stress cracking influence on the plastics materials in question, shall be subjected to a superimposed load equivalent to the total mass of identical packages which might be stacked on it during transport. The minimum height of the stack including the test sample shall be 3 m.

6.1.5.3 Drop test

6.1.5.3.1 Number of test samples (per design type and manufacturer) and drop orientation

For other than flat drops, the centre of gravity shall be vertically over the point of impact.

Packaging	Number of test samples	Drop orientation
Steel drums Aluminium drums Metal drums, other than steel or aluminium drums Steel jerricans Aluminium jerricans Plywood drums Fibre drums Plastics drums and jerricans Composite packagings which are in the shape of a drum	Six (three for each drop)	<i>First drop</i> (using three samples): the packaging shall strike the target diagonally on the chime or, if the packaging has no chime, on a circumferential seam or an edge <i>Second drop</i> (using the other three samples): the packaging shall strike the target on the weakest part not tested by the first drop, for example a closure or, for some cylindrical drums, the welded longitudinal seam of the body
Boxes of natural wood Plywood boxes Reconstituted wood boxes Fibreboard boxes Plastics boxes Steel or aluminium boxes Composite packagings which are in the shape of a box	Five (one for each drop)	<i>First drop:</i> flat on the bottom <i>Second drop:</i> flat on the top <i>Third drop:</i> flat on the long side <i>Fourth drop:</i> flat on the short side <i>Fifth drop:</i> on a corner
Bags – single-ply with a side seam	Three (three drops per bag)	<i>First drop:</i> flat on a wide face <i>Second drop:</i> flat on a narrow face <i>Third drop:</i> on the end of the bag
Bags – single-ply without a side seam or multi-ply	Three (two drops per bag)	<i>First drop:</i> flat on a wide face <i>Second drop:</i> on an end of the bag

Where more than one orientation is possible for a given drop test, the orientation most likely to result in failure of the packaging shall be used.

6.1.5.3.2 Special preparation of test samples for the drop test

The temperature of the test sample and its contents shall be reduced to -18°C or lower for the following packagings:

- .1 plastics drums (see 6.1.4.8);



- .2 plastics jerricans (see 6.1.4.8);
- .3 plastics boxes other than expanded plastics boxes (see 6.1.4.13);
- .4 composite packagings (plastics material) (see 6.1.4.19); and
- .5 combination packagings with plastics inner packagings, other than plastics bags intended to contain solids or articles.

Where the test samples are prepared in this way, the conditioning in 6.1.5.2.3 may be waived. Test liquids shall be kept in the liquid state by the addition of anti-freeze if necessary.

6.1.5.3.3 Removable head packagings for liquids shall not be dropped until at least 24 hours after filling and closing to allow for any possible gasket relaxation.

6.1.5.3.4 **Target**

The target shall be a non-resilient and horizontal surface and shall be:

- .1 integral and massive enough to be immovable;
- .2 flat with a surface kept free from local defects capable of influencing the test results;
- .3 rigid enough to be non-deformable under test conditions and not liable to become damaged by the tests; and
- .4 sufficiently large to ensure that the test package falls entirely upon the surface.

6.1.5.3.5 **Drop height**

For solids and liquids, if the test is performed with the solid or liquid to be carried or with another substance having essentially the same physical characteristics:

Packing group I	Packing group II	Packing group III
1.8 m	1.2 m	0.8 m

For liquids in single packagings and for inner packagings of combination packagings, if the test is performed with water:

**Note:** The term “water” includes water/antifreeze solutions with a minimum specific gravity of 0.95 for testing at –18°C.

(a) where the substances to be transported have a relative density not exceeding 1.2:

Packing group I	Packing group II	Packing group III
1.8 m	1.2 m	0.8 m

(b) where the substances to be transported have a relative density exceeding 1.2, the drop height shall be calculated on the basis of the relative density (*d*) of the substance to be carried, rounded up to the first decimal, as follows:

Packing group I	Packing group II	Packing group III
$d \times 1.5$ m	$d \times 1.0$ m	$d \times 0.67$ m

6.1.5.3.6 **Criteria for passing the test**

- .1 Each packaging containing liquid shall be leakproof when equilibrium has been reached between the internal and external pressures, except for inner packagings of combination packagings, when it is not necessary that the pressures be equalized.
- .2 Where a packaging for solids undergoes a drop test and its upper face strikes the target, the test sample passes the test if the entire contents are retained by an inner packaging or inner receptacle (such as a plastics bag), even if the closure, while retaining its containment function, is no longer sift-proof.
- .3 The packaging or outer packaging of a composite or combination packaging shall not exhibit any damage liable to affect safety during transport. Inner receptacles, inner packagings, or articles shall remain completely within the outer packaging and there shall be no leakage of the filling substance from the inner receptacles or inner packaging(s).
- .4 Neither the outermost ply of a bag nor an outer packaging shall exhibit any damage liable to affect safety during transport.
- .5 A slight discharge from the closures upon impact shall not be considered to be a failure of the packaging provided that no further leakage occurs.

**Part 6 – Construction and testing of packagings, IBCs, etc.**

- .6 No rupture is permitted in packagings for goods of class 1 which would permit the spillage of loose explosive substances or articles from the outer packaging.

**6.1.5.4 Leakproofness test**

- 6.1.5.4.1 The leakproofness test shall be performed on all design types of packagings intended to contain liquids; however, this test is not required for the inner packagings of combination packagings.
- 6.1.5.4.2 Number of test samples: three test samples per design type and manufacturer.
- 6.1.5.4.3 Special preparation of test samples for the test: vented closures shall either be replaced by similar non-vented closures or the vent shall be sealed.
- 6.1.5.4.4 Test method and pressure to be applied: the packagings, including their closures, shall be restrained under water for 5 minutes while an internal air pressure is applied. The method of restraint shall not affect the results of the test.

The air pressure (gauge) to be applied shall be:

Packing group I	Packing group II	Packing group III
Not less than 30 kPa (0.3 bar)	Not less than 20 kPa (0.2 bar)	Not less than 20 kPa (0.2 bar)

Other methods at least equally as effective may be used.

- 6.1.5.4.5 Criterion for passing the test: there shall be no leakage.

**6.1.5.5 Internal pressure (hydraulic) test**

- 6.1.5.5.1 Packagings to be tested: the internal pressure (hydraulic) test shall be carried out on all design types of metal, plastics and composite packagings intended to contain liquids. This test is not required for inner packagings of combination packagings.
- 6.1.5.5.2 Number of test samples: three test samples per design type and manufacture.
- 6.1.5.5.3 Special preparation of packagings for testing: vented closures shall either be replaced by similar non-vented closures or the vent shall be sealed.
- 6.1.5.5.4 Test method and pressure to be applied: metal packagings and composite packagings (glass, porcelain or stoneware), including their closures, shall be subjected to the test pressure for 5 minutes. Plastics packagings and composite packagings (plastics material), including their closures, shall be subjected to the test pressure for 30 minutes. This pressure is the one to be included in the marking required by 6.1.3.1(d). The manner in which the packagings are supported shall not invalidate the test. The test pressure shall be applied continuously and evenly; it shall be kept constant throughout the test period. The hydraulic pressure (gauge) applied, as determined by any one of the following methods, shall be:
  - .1 not less than the total gauge pressure measured in the packaging (i.e., the vapour pressure of the filling liquid and the partial pressure of the air or other inert gases, minus 100 kPa) at 55°C, multiplied by a safety factor of 1.5; this total gauge pressure shall be determined on the basis of a maximum degree of filling in accordance with 4.1.1.4 and a filling temperature of 15°C;
  - .2 not less than 1.75 times the vapour pressure at 50°C of the liquid to be transported, minus 100 kPa, but with a minimum test pressure of 100 kPa;
  - .3 not less than 1.5 times the vapour pressure at 55°C of the liquid to be transported minus 100 kPa, but with a minimum test pressure of 100 kPa.
- 6.1.5.5.5 In addition, packagings intended to contain liquids of packing group I shall be tested to a minimum test pressure of 250 kPa (gauge) for a test period of 5 or 30 minutes, depending upon the material of construction of the packaging.
- 6.1.5.5.6 Criterion for passing the test: no packaging shall leak.

**6.1.5.6 Stacking test**

All design types of packagings other than bags shall be subjected to a stacking test.

- 6.1.5.6.1 Number of test samples: three test samples per design type and manufacturer.
- 6.1.5.6.2 Test method: the test sample shall be subjected to a force applied to the top surface of the test sample equivalent to the total mass of identical packages which might be stacked on it during transport: where the contents of the test sample are liquids with relative density different from that of the liquid to be transported,

the force shall be calculated in relation to the latter. The minimum height of the stack including the test sample shall be 3 m. The duration of the test shall be 24 hours except that plastics drums, jerricans, and composite packagings 6HH1 and 6HH2 intended for liquids shall be subjected to the stacking test for a period of 28 days at a temperature of not less than 40°C.

**6.1.5.6.3** Criteria for passing the test: no test sample shall leak. In composite packagings or combination packagings, there shall be no leakage of the filling substance from the inner receptacle or inner packaging. No test sample shall show any deterioration which could adversely affect transport safety or any distortion liable to reduce its strength or cause instability in stacks of packages. Plastics packagings shall be cooled to ambient temperature before the assessment.

**6.1.5.7 Test report**

**6.1.5.7.1** A test report containing at least the following particulars shall be drawn up and shall be available to the users of the packaging:

- .1 name and address of the test facility;
- .2 name and address of applicant (where applicable);
- .3 a unique test report identification;
- .4 date of the test report;
- .5 manufacturer of the packaging;
- .6 description of the packaging design type (such as dimensions, materials, closures, thickness, etc.), including method of manufacture (such as blow-moulding), and which may include drawing(s) and/or photograph(s);
- .7 maximum capacity;
- .8 characteristics of test contents, such as viscosity and relative density for liquids and particle size for solids;
- .9 test descriptions and results;
- .10 signature, with the name and status of the signatory.

**6.1.5.7.2** The test report shall contain statements that the packaging prepared as for transport was tested in accordance with the appropriate provisions of this chapter and that the use of other packaging methods or components may render it invalid. A copy of the test report shall be available to the competent authority.

## Chapter 6.2

### *Provisions for the construction and testing of pressure receptacles, aerosol dispensers, small receptacles containing gas (gas cartridges) and fuel cell cartridges containing liquefied flammable gas*

**Note:** Aerosol dispensers, small receptacles containing gas (gas cartridges) and fuel cell cartridges containing liquefied flammable gas are not subject to the provisions of 6.2.1 to 6.2.3.

#### 6.2.1 General provisions

##### 6.2.1.1 Design and construction

6.2.1.1.1 Pressure receptacles and their closures shall be designed, manufactured, tested and equipped in such a way as to withstand all conditions, including fatigue, to which they will be subjected during normal conditions of transport.

6.2.1.1.2 In recognition of scientific and technological advances, and recognizing that pressure receptacles other than those that are marked with a UN certification marking may be used on a national or regional basis, pressure receptacles conforming to requirements other than those specified in this Code may be used if approved by the competent authorities in the countries of transport and use.

6.2.1.1.3 In no case shall the minimum wall thickness be less than that specified in the design and construction technical standards.

6.2.1.1.4 For welded pressure receptacles, only metals of weldable quality shall be used.

6.2.1.1.5 The test pressure of cylinders, tubes, pressure drums and bundles of cylinders shall be in accordance with packing instruction P200, or, for a chemical under pressure, with packing instruction P206. The test pressure for closed cryogenic receptacles shall be in accordance with packing instruction P203. The test pressure of a metal hydride storage system shall be in accordance with packing instruction P205.

6.2.1.1.6 Pressure receptacles assembled in bundles shall be structurally supported and held together as a unit. Pressure receptacles shall be secured in a manner that prevents movement in relation to the structural assembly and movement that would result in the concentration of harmful local stresses. Manifold assemblies (e.g., manifold, valves, and pressure gauges) shall be designed and constructed such that they are protected from impact damage and forces normally encountered in transport. Manifolds shall have at least the same test pressure as the cylinders. For toxic liquefied gases, each pressure receptacle shall have an isolation valve to ensure that each pressure receptacle can be filled separately and that no interchange of pressure receptacle contents can occur during transport.

6.2.1.1.7 Contact between dissimilar metals which could result in damage by galvanic action shall be avoided.

6.2.1.1.8 The following additional provisions apply to the construction of closed cryogenic receptacles for refrigerated liquefied gases:

- .1 The mechanical properties of the metal used shall be established for each pressure receptacle, including the impact strength and the bending coefficient;
- .2 The pressure receptacles shall be thermally insulated. The thermal insulation shall be protected against impact by means of a jacket. If the space between the pressure receptacle and the jacket is evacuated of air (vacuum insulation), the jacket shall be designed to withstand, without permanent deformation, an external pressure of at least 100 kPa (1 bar) calculated in accordance with a recognized technical code or a calculated critical collapsing pressure of not less than 200 kPa (2 bar) gauge pressure. If the jacket is so closed as to be gas-tight (e.g., in the case of vacuum insulation), a device shall be provided to prevent any dangerous pressure from developing in the insulating layer in the event of inadequate gas-tightness of the pressure receptacle or its fittings. The device shall prevent moisture from penetrating into the insulation.

- .3 Closed cryogenic receptacles intended for the transport of refrigerated liquefied gases having a boiling point below  $-182^{\circ}\text{C}$  at atmospheric pressure shall not include materials which may react with oxygen or oxygen-enriched atmospheres in a dangerous manner, when located in parts of the thermal insulation where there is a risk of contact with oxygen or with oxygen-enriched liquid.
- .4 Closed cryogenic receptacles shall be designed and constructed with suitable lifting and securing arrangements.

**6.2.1.1.9 Additional requirements for the construction of pressure receptacle for acetylene**

Pressure receptacle for UN 1001 acetylene, dissolved, and UN 3374 acetylene, solvent free, shall be filled with a porous material, uniformly distributed, of a type that conforms to the requirements and testing specified by the competent authority and which:

- .1 is compatible with the pressure receptacle and does not form harmful or dangerous compounds either with the acetylene or with the solvent in the case of UN 1001; and
- .2 is capable of preventing the spread of decomposition of the acetylene in the porous material.

In the case of UN 1001, the solvent shall be compatible with the pressure receptacle.

**6.2.1.2 Materials**

**6.2.1.2.1** Construction materials of pressure receptacles and their closures which are in direct contact with dangerous goods shall not be affected or weakened by the dangerous goods intended to be transported and shall not cause a dangerous effect, e.g., catalysing a reaction or reacting with the dangerous goods.

**6.2.1.2.2** Pressure receptacles and their closures shall be made of the materials specified in the design and construction technical standards and the applicable packing instruction for the substances intended for transport in the pressure receptacle. The materials shall be resistant to brittle fracture and to stress corrosion cracking as indicated in the design and construction technical standards.

**6.2.1.3 Service equipment**

**6.2.1.3.1** Valves, piping and other fittings subjected to pressure, excluding pressure relief devices, shall be designed and constructed so that the burst pressure is at least 1.5 times the test pressure of the pressure receptacle.

**6.2.1.3.2** Service equipment shall be configured or designed to prevent damage that could result in the release of the pressure receptacle contents during normal conditions of handling and transport. Manifold piping leading to shut-off valves shall be sufficiently flexible to protect the valves and the piping from shearing or releasing the pressure receptacle contents. The filling and discharge valves and any protective caps shall be capable of being secured against unintended opening. Valves shall be protected as specified in 4.1.6.1.8.

**6.2.1.3.3** Pressure receptacles which are not capable of being handled manually or rolled shall be fitted with devices (skids, rings, straps) ensuring that they can be safely handled by mechanical means and so arranged as not to impair the strength of, nor cause undue stresses in, the pressure receptacle.

**6.2.1.3.4** Individual pressure receptacles shall be equipped with pressure relief devices as specified in packing instruction P200(1), P205 or in 6.2.1.3.6.4 and 6.2.1.3.6.5. Pressure relief devices shall be designed to prevent the entry of foreign matter, the leakage of gas and the development of any dangerous excess pressure. When fitted, pressure relief devices on manifolded horizontal pressure receptacles filled with flammable gas shall be arranged to discharge freely to the open air in such a manner as to prevent any impingement of escaping gas upon the pressure receptacle itself under normal conditions of transport.

**6.2.1.3.5** Pressure receptacles where filling is measured by volume shall be provided with a level indicator.

**6.2.1.3.6 Additional provisions for closed cryogenic receptacles**

**6.2.1.3.6.1** Each filling and discharge opening in a closed cryogenic receptacle used for the transport of flammable refrigerated liquefied gases shall be fitted with at least two mutually independent shut-off devices in series, the first being a stop-valve, the second being a cap or equivalent device.

**6.2.1.3.6.2** For sections of piping which can be closed at both ends and where liquid product can be trapped, a method of automatic pressure relief shall be provided to prevent excess pressure build-up within the piping.

**6.2.1.3.6.3** Each connection on a closed cryogenic receptacle shall be clearly marked to indicate its function (e.g., vapour or liquid phase).

**6.2.1.3.6.4 Pressure relief devices**

**6.2.1.3.6.4.1** Each closed cryogenic receptacle shall be provided with at least one pressure relief device. The pressure relief device shall be of the type that will resist dynamic forces, including surge.

## Part 6 – Construction and testing of packagings, IBCs, etc.

- 6.2.1.3.6.4.2 Closed cryogenic receptacles may, in addition, have a frangible disc in parallel with the spring-loaded device(s) in order to meet the provisions of 6.2.1.3.6.5.
- 6.2.1.3.6.4.3 Connections to pressure relief devices shall be of sufficient size to enable the required discharge to pass unrestricted to the pressure relief device.
- 6.2.1.3.6.4.4 All pressure relief device inlets shall, under maximum filling conditions, be situated in the vapour space of the closed cryogenic receptacle and the devices shall be so arranged as to ensure that the escaping vapour is discharged unrestrictedly.
- 6.2.1.3.6.5 *Capacity and setting of pressure relief devices*
- Note:** In relation to pressure relief devices of closed cryogenic receptacles, “MAWP” means the maximum effective gauge pressure permissible at the top of a loaded closed cryogenic receptacle in its operating position, including the highest effective pressure during filling and discharge.
- 6.2.1.3.6.5.1 The pressure relief device shall open automatically at a pressure not less than the MAWP and be fully open at a pressure equal to 110% of the MAWP. It shall, after discharge, close at a pressure not lower than 10% below the pressure at which discharge starts and shall remain closed at all lower pressures.
- 6.2.1.3.6.5.2 Frangible discs shall be set to rupture at a nominal pressure which is the lower of either the test pressure or 150% of the MAWP.
- 6.2.1.3.6.5.3 In the case of the loss of vacuum in a vacuum-insulated closed cryogenic receptacle, the combined capacity of all pressure relief devices installed shall be sufficient so that the pressure (including accumulation) inside the closed cryogenic receptacle does not exceed 120% of the MAWP.
- 6.2.1.3.6.5.4 The required capacity of the pressure relief devices shall be calculated in accordance with an established technical code recognized by the competent authority.\*
- 6.2.1.4 **Approval of pressure receptacles**
- 6.2.1.4.1 The conformity of pressure receptacles shall be assessed at time of manufacture as required by the competent authority. Pressure receptacles shall be inspected, tested and approved by an inspection body. The technical documentation shall include full specifications on design and construction, and full documentation on the manufacturing and testing.
- 6.2.1.4.2 Quality assurance systems shall conform to the requirements of the competent authority.
- 6.2.1.5 **Initial inspection and test**
- 6.2.1.5.1 New pressure receptacles, other than closed cryogenic receptacles and metal hydride storage systems, shall be subjected to testing and inspection during and after manufacture in accordance with the applicable design standards including the following:
- On an adequate sample of pressure receptacles:
- .1 testing of the mechanical characteristics of the material of construction;
  - .2 verification of the minimum wall thickness;
  - .3 verification of the homogeneity of the material for each manufacturing batch;
  - .4 inspection of the external and internal conditions of the pressure receptacles;
  - .5 inspection of the neck threads;
  - .6 verification of the conformance with the design standard;
- For all pressure receptacles:
- .7 a hydraulic pressure test. Pressure receptacles shall withstand the test pressure without expansion greater than that allowed in the design specification;
- Note:** With the agreement of the competent authority, the hydraulic pressure test may be replaced by a test using a gas, where such an operation does not entail any danger.
- .8 inspection and assessment of manufacturing defects and either repairing them or rendering the pressure receptacles unserviceable. In the case of welded pressure receptacles, particular attention shall be paid to the quality of the welds;
  - .9 an inspection of the markings on the pressure receptacles;

\* See, for example, CGA S-1.2-2003 “Pressure Relief Device Standards – Part 2 – Cargo and Portable Tanks for Compressed Gases” and S-1.1-2003 “Pressure Relief Device Standards – Part 1 – Cylinders for Compressed Gases”.

.10 in addition, pressure receptacles intended for the transport of UN 1001 acetylene, dissolved and UN 3374 acetylene, solvent free shall be inspected to ensure proper installation and condition of the porous material and, if applicable, the quantity of solvent.

**6.2.1.5.2** On an adequate sample of closed cryogenic receptacles, the inspections and tests specified in 6.2.1.5.1.1, .2, .4, and .6 shall be performed. In addition, welds shall be inspected by radiographic, ultrasonic or another suitable non-destructive test method on a sample of closed cryogenic receptacles, according to the applicable design and construction standard. This weld inspection does not apply to the jacket.

Additionally, all closed cryogenic receptacles shall undergo the inspections and tests specified in 6.2.1.5.1, .7, .8, and .9, as well as a leakproofness test and a test of the satisfactory operation of the service equipment after assembly.

**6.2.1.5.3** For metal hydride storage systems, it shall be verified that the inspections and tests specified in 6.2.1.5.1.1, .2, .3, .4, .5 if applicable, .6, .7, .8 and .9 have been performed on an adequate sample of the receptacles used in the metal hydride storage system. In addition, on an adequate sample of metal hydride storage systems, the inspections and tests specified in 6.2.1.5.1.3 and .6 shall be performed, as well as 6.2.1.5.1.5, if applicable, and inspection of the external conditions of the metal hydride storage system.

Additionally, all metal hydride storage systems shall undergo the initial inspections and tests specified in 6.2.1.5.1.8 and .9, as well as a leakproofness test and a test of the satisfactory operation of the service equipment.

**6.2.1.6 Periodic inspection and test**

**6.2.1.6.1** Refillable pressure receptacles, other than cryogenic receptacles, shall be subjected to periodic inspections and tests, by a body authorized by the competent authority, in accordance with the following:

- .1 Check of the external conditions of the pressure receptacle and verification of the equipment and the external markings;
- .2 Check of the internal conditions of the pressure receptacle (e.g., internal inspection, verification of minimum wall thickness);
- .3 Check of the threads if there is evidence of corrosion or if the fittings are removed;
- .4 A hydraulic pressure test and, if necessary, verification of the characteristics of the material by suitable tests;

**Note 1:** With the agreement of the competent authority, the hydraulic pressure test may be replaced by a test using a gas, where such an operation does not entail any danger.

**Note 2:** With the agreement of the competent authority, the hydraulic pressure test of cylinders or tubes may be replaced by an equivalent method based on acoustic emission testing or a combination of acoustic emission testing and ultrasonic examination. ISO 16148:2006 may be used as a guide for acoustic emission testing procedures.

**Note 3:** The hydraulic pressure test may be replaced by ultrasonic examination carried out in accordance with ISO 10461:2005+A1:2006 for seamless aluminium alloy gas cylinders and in accordance with ISO 6406:2005 for seamless steel gas cylinders.

- .5 Check of service equipment, other accessories and pressure-relief devices, if to be reintroduced into service.

**Note:** For the periodic inspection and test frequencies, see packing instruction P200 or, for a chemical under pressure, packing instruction P206 of 4.1.4.1.

**6.2.1.6.2** Pressure receptacles intended for the transport of UN 1001 acetylene, dissolved and UN 3374 acetylene, solvent free shall be examined only as specified in 6.2.1.6.1.1, 6.2.1.6.3 and 6.2.1.6.1.5. In addition, the condition of the porous material (e.g., cracks, top clearance, loosening, or settlement) shall be examined.

**6.2.1.6.3** Pressure relief valves for closed cryogenic receptacles shall be subject to periodic inspections and tests.

**6.2.1.7 Requirements for manufacturers**

**6.2.1.7.1** The manufacturer shall be technically able and shall possess all resources required for the satisfactory manufacture of pressure receptacles; this relates in particular to qualified personnel:

- .1 to supervise the entire manufacturing process;
- .2 to carry out joining of materials; and
- .3 to carry out the relevant tests.

**6.2.1.7.2** The proficiency test of a manufacturer shall in all instances be carried out by an inspection body approved by the competent authority of the country of approval.

Part 6 – Construction and testing of packagings, IBCs, etc.

6.2.1.8 Requirements for inspection bodies

6.2.1.8.1 Inspection bodies shall be independent from manufacturing enterprises and competent to perform the tests, inspections and approvals required.

6.2.2 Provisions for UN pressure receptacles

In addition to the general requirements of 6.2.1, UN pressure receptacles shall comply with the provisions of this section, including the standards, as applicable.

**Note:** With the agreement of the competent authority, more recently published versions of the standards, if available, may be used.

6.2.2.1 Design, construction and initial inspection and test

6.2.2.1.1 The following standards apply for the design, construction, and initial inspection and test of UN cylinders, except that inspection requirements related to the conformity assessment system and approval shall be in accordance with 6.2.2.5:

ISO 9809-1:1999	Gas cylinders – Refillable seamless steel gas cylinders – Design, construction and testing – Part 1: Quenched and tempered steel cylinders with tensile strength less than 1100 MPa. <b>Note:</b> The note concerning the <i>F</i> factor in section 7.3 of this standard shall not be applied for UN cylinders.
ISO 9809-2:2000	Gas cylinders – Refillable seamless steel gas cylinders – Design, construction and testing – Part 2: Quenched and tempered steel cylinders with tensile strength greater than or equal to 1100 MPa
ISO 9809-3:2000	Gas cylinders – Refillable seamless steel gas cylinders – Design, construction and testing – Part 3: Normalized steel cylinders
ISO 7866:1999	Gas cylinders – Refillable seamless aluminium alloy gas cylinders – Design, construction and testing <b>Note:</b> The note concerning the <i>F</i> factor in section 7.2 of this standard shall not be applied for UN cylinders. Aluminium alloy 6351A-T6 or equivalent shall not be authorized.
ISO 4706:2008	Gas cylinders – Refillable welded steel cylinders – Test pressure 60 bar and below
ISO 18172-1:2007	Gas cylinders – Refillable welded stainless steel cylinders – Part 1: Test pressure 6 MPa and below
ISO 20703:2006	Gas cylinders – Refillable welded aluminium-alloy cylinders – Design, construction and testing
ISO 11118:1999	Gas cylinders – Non-refillable metallic gas cylinders – Specification and test methods
ISO 11119-1:2002	Gas cylinders of composite construction – Specification and test methods – Part 1: Hoop wrapped composite gas cylinders
ISO 11119-2:2002	Gas cylinders of composite construction – Specification and test methods – Part 2: Fully wrapped fibre reinforced composite gas cylinders with load-sharing metal liners
ISO 11119-3:2002	Gas cylinders of composite construction – Specification and test methods – Part 3: Fully wrapped fibre reinforced composite gas cylinders with non-load-sharing metallic or non-metallic liners

**Note 1:** In the above referenced standards, composite cylinders shall be designed for unlimited service life.

**Note 2:** After the first 15 years of service, composite cylinders manufactured according to these standards may be approved for extended service by the competent authority which was responsible for the original approval of the cylinders and which will base its decision on the test information supplied by the manufacturer or owner or user.

6.2.2.1.2 The following standards apply for the design, construction, and initial inspection and test of UN tubes, except that inspection requirements related to the conformity assessment system and approval shall be in accordance with 6.2.2.5:

ISO 11120:1999	Gas cylinders – Refillable seamless steel tubes for compressed gas transport, of water capacity between 150 ℓ and 3000 ℓ – Design, construction and testing <b>Note:</b> The note concerning the <i>F</i> factor in section 7.1 of this standard shall not be applied for UN tubes.
----------------	--



**Chapter 6.2 – Provisions for the construction and testing of receptacles for gases**

- 6.2.2.1.3** The following standards apply for the design, construction and initial inspection and test of UN acetylene cylinders, except that inspection requirements related to the conformity assessment system and approval shall be in accordance with 6.2.2.5:

For the cylinder shell:

ISO 9809-1:1999	Gas cylinders – Refillable seamless steel gas cylinders – Design, construction and testing – Part 1: Quenched and tempered steel cylinders with tensile strength less than 1100 MPa <b>Note:</b> The note concerning the <i>F</i> factor in section 7.3 of this standard shall not be applied for UN cylinders.
ISO 9809-3:2000	Gas cylinders – Refillable seamless steel gas cylinders – Design, construction and testing – Part 3: Normalized steel cylinders

For the porous material in the cylinder:

ISO 3807-1:2000	Cylinders for acetylene – Basic requirements – Part 1: Cylinders without fusible plugs
ISO 3807-2:2000	Cylinders for acetylene – Basic requirements – Part 2: Cylinders with fusible plugs

- 6.2.2.1.4** The following standard applies for the design, construction and initial inspection and test of UN cryogenic receptacles, except that inspection requirements related to the conformity assessment system and approval shall be in accordance with 6.2.2.5:

ISO 21029-1:2004	Cryogenic vessels – Transportable vacuum insulated vessels of not more than 1000 litres volume – Part 1: Design, fabrication, inspection and tests
------------------	--

- 6.2.2.1.5** The following standard applies for the design, construction, and initial inspection and test of UN metal hydride storage systems, except that inspection requirements related to the conformity assessment system and approval shall be in accordance with 6.2.2.5:

ISO 16111:2008	Transportable gas storage devices – Hydrogen absorbed in reversible metal hydride
----------------	---

**6.2.2.2 Materials**

In addition to the material requirements specified in the pressure receptacle design and construction standards, and any restrictions specified in the applicable packing instruction for the gas(es) to be transported (e.g., packing instruction P200 or P205), the following standards apply to material compatibility:

ISO 11114-1:1997	Transportable gas cylinders – Compatibility of cylinder and valve materials with gas contents – Part 1: Metallic materials
ISO 11114-2:2000	Transportable gas cylinders – Compatibility of cylinder and valve materials with gas contents – Part 2: Non-metallic materials

**Note:** The limitations imposed in ISO 11114-1 on high strength steel alloys at ultimate tensile strength levels up to 1100 MPa do not apply to SILANE (UN 2203).

**6.2.2.3 Service equipment**

The following standards apply to closures and their protection:

ISO 11117:1998 + Cor 1:2009	Gas cylinders – Valve protection caps and valve guards – Design, construction and tests <b>Note:</b> Construction according to ISO 11117:1998 may continue until 31 December 2014.
ISO 10297:2006	Gas cylinders – Refillable gas cylinder valves – Specification and type testing
ISO 13340:2001	Transportable gas cylinders – Cylinders valves for non-refillable cylinders – Specification and prototype testing

For UN metal hydride storage systems, the requirements specified in the following standard apply to closures and their protection:

ISO 16111:2008	Transportable gas storage devices – Hydrogen absorbed in reversible metal hydride
----------------	---

**Part 6 – Construction and testing of packagings, IBCs, etc.**

**6.2.2.4 Periodic inspection and test**

The following standards apply to the periodic inspection and testing of UN cylinders and UN metal hydride storage systems:

ISO 6406:2005	Seamless steel gas cylinders – Periodic inspection and testing
ISO 10461:2005/ Amd 1:2006	Seamless aluminium-alloy gas cylinders – Periodic inspection and testing
ISO 10462:2005	Transportable cylinders for dissolved acetylene – Periodic inspection and maintenance
ISO 11623:2002	Transportable gas cylinders – Periodic inspection and testing of composite gas cylinders
ISO 16111:2008	Transportable gas storage devices – Hydrogen absorbed in reversible metal hydride
ISO 10460:2005	Gas cylinders – Welded carbon-steel gas cylinders – Periodic inspection and testing <b>Note:</b> The repair of welds described in clause 12.1 of this standard shall not be permitted. Repairs described in clause 12.2 require the approval of the competent authority which approved the periodic inspection and test body in accordance with 6.2.2.6.

**6.2.2.5 Conformity assessment system and approval for manufacture of pressure receptacles**

**6.2.2.5.1 Definitions**

For the purposes of this section:

*Conformity assessment system* means a system for competent authority approval of a manufacturer, by pressure receptacle design type approval, approval of manufacturer’s quality system and approval of inspection bodies;

*Design type* means a pressure receptacle design as specified by a particular pressure receptacle standard;

*Verify* means confirm by examination or provision of objective evidence that specified requirements have been fulfilled.

**6.2.2.5.2 General requirements**

*Competent authority*

**6.2.2.5.2.1** The competent authority that approves the pressure receptacle shall approve the conformity assessment system for the purpose of ensuring that pressure receptacles conform to the provisions of this Code. In instances where the competent authority that approves a pressure receptacle is not the competent authority in the country of manufacture, the marks of the approval country and the country of manufacture shall be indicated in the pressure receptacle marking (see 6.2.2.7 and 6.2.2.8).

The competent authority of the country of approval shall supply, upon request, evidence demonstrating compliance of this conformity assessment system to its counterpart in a country of use.

**6.2.2.5.2.2** The competent authority may delegate its functions in this conformity assessment system in whole or in part.

**6.2.2.5.2.3** The competent authority shall ensure that a current list of approved inspection bodies and their identity marks and approved manufacturers and their identity marks is available.

*Inspection body*

**6.2.2.5.2.4** The inspection body shall be approved by the competent authority for the inspection of pressure receptacles and shall:

- .1 have a staff with an organizational structure, capable, trained, competent, and skilled, to satisfactorily perform its technical functions;
- .2 have access to suitable and adequate facilities and equipment;
- .3 operate in an impartial manner and be free from any influence which could prevent it from doing so;
- .4 ensure commercial confidentiality of the commercial and proprietary activities of the manufacturer and other bodies;
- .5 maintain clear demarcation between actual inspection body functions and unrelated functions;
- .6 operate a documented quality system;
- .7 ensure that the tests and inspections specified in the relevant pressure receptacle standard and in this Code are performed; and
- .8 maintain an effective and appropriate report and record system in accordance with 6.2.2.5.6.

- 6.2.2.5.2.5 The inspection body shall perform design type approval, pressure receptacle production testing and inspection, and certification to verify conformity with the relevant pressure receptacle standard (see 6.2.2.5.4 and 6.2.2.5.5).

*Manufacturer*

- 6.2.2.5.2.6 The manufacturer shall:
- .1 operate a documented quality system in accordance with 6.2.2.5.3;
  - .2 apply for design type approvals in accordance with 6.2.2.5.4;
  - .3 select an inspection body from the list of approved inspection bodies maintained by the competent authority in the country of approval; and
  - .4 maintain records in accordance with 6.2.2.5.6.

*Testing laboratory*

- 6.2.2.5.2.7 The testing laboratory shall have:
- .1 staff with an organizational structure, sufficient in number, competence, and skill; and
  - .2 suitable and adequate facilities and equipment to perform the tests required by the manufacturing standard to the satisfaction of the inspection body.

6.2.2.5.3 **Manufacturer's quality system**

- 6.2.2.5.3.1 The quality system shall contain all the elements, requirements, and provisions adopted by the manufacturer. It shall be documented in a systematic and orderly manner in the form of written policies, procedures and instructions.

The contents shall in particular include adequate descriptions of:

- .1 the organizational structure and responsibilities of personnel with regard to design and product quality;
- .2 the design control and design verification techniques, processes, and procedures that will be used when designing the pressure receptacles;
- .3 the relevant pressure receptacle manufacturing, quality control, quality assurance and process operation instructions that will be used;
- .4 quality records, such as inspection reports, test data and calibration data;
- .5 management reviews to ensure the effective operation of the quality system arising from the audits in accordance with 6.2.2.5.3.2;
- .6 the process describing how customer requirements are met;
- .7 the process for control of documents and their revision;
- .8 the means for control of non-conforming pressure receptacles, purchased components, in-process and final materials; and
- .9 training programmes and qualification procedures for relevant personnel.

6.2.2.5.3.2 *Audit of the quality system*

The quality system shall be initially assessed to determine whether it meets the requirements in 6.2.2.5.3.1 to the satisfaction of the competent authority.

The manufacturer shall be notified of the results of the audit. The notification shall contain the conclusions of the audit and any corrective actions required.

Periodic audits shall be carried out, to the satisfaction of the competent authority, to ensure that the manufacturer maintains and applies the quality system. Reports of the periodic audits shall be provided to the manufacturer.

6.2.2.5.3.3 *Maintenance of the quality system*

The manufacturer shall maintain the quality system as approved in order that it remains adequate and efficient.

The manufacturer shall notify the competent authority that approved the quality system of any intended changes. The proposed changes shall be evaluated in order to determine whether the amended quality system will still satisfy the requirements in 6.2.2.5.3.1.

**Part 6 – Construction and testing of packagings, IBCs, etc.**

---

**6.2.2.5.4 Approval process**

*Initial design type approval*

- 6.2.2.5.4.1 The initial design type approval shall consist of approval of the manufacturer's quality system and approval of the pressure receptacle design to be produced. An application for an initial design type approval shall meet the requirements of 6.2.2.5.3, 6.2.2.5.4.2 to 6.2.2.5.4.6 and 6.2.2.5.4.9.
- 6.2.2.5.4.2 A manufacturer desiring to produce pressure receptacles in accordance with a pressure receptacle standard and this Code shall apply for, obtain, and retain a Design Type Approval Certificate issued by the competent authority in the country of approval for at least one pressure receptacle design type in accordance with the procedure given in 6.2.2.5.4.9. This certificate shall, on request, be submitted to the competent authority of the country of use.
- 6.2.2.5.4.3 An application shall be made for each manufacturing facility and shall include:
- .1 the name and registered address of the manufacturer and in addition, if the application is submitted by an authorized representative, its name and address;
  - .2 the address of the manufacturing facility (if different from the above);
  - .3 the name and title of the person(s) responsible for the quality system;
  - .4 the designation of the pressure receptacle and the relevant pressure receptacle standard;
  - .5 details of any refusal of approval of a similar application by any other competent authority;
  - .6 the identity of the inspection body for design type approval;
  - .7 documentation on the manufacturing facility as specified under 6.2.2.5.3.1; and
  - .8 the technical documentation required for design type approval, which shall enable verification of the conformity of the pressure receptacles with the requirements of the relevant pressure receptacle design standard. The technical documentation shall cover the design and method of manufacture and shall contain, as far as is relevant for assessment, at least the following:
    - .1 pressure receptacle design standard, design and manufacturing drawings, showing components and sub-assemblies, if any;
    - .2 descriptions and explanations necessary for the understanding of the drawings and intended use of the pressure receptacles;
    - .3 a list of the standards necessary to fully define the manufacturing process;
    - .4 design calculations and material specifications; and
    - .5 design type approval test reports, describing the results of examinations and tests carried out in accordance with 6.2.2.5.4.9.
- 6.2.2.5.4.4 An initial audit in accordance with 6.2.2.5.3.2 shall be performed to the satisfaction of the competent authority.
- 6.2.2.5.4.5 If the manufacturer is denied approval, the competent authority shall provide written detailed reasons for such denial.
- 6.2.2.5.4.6 Following approval, changes to the information submitted under 6.2.2.5.4.3 relating to the initial approval shall be provided to the competent authority.

*Subsequent design type approvals*

- 6.2.2.5.4.7 An application for a subsequent design type approval shall encompass the requirements of 6.2.2.5.4.8 and 6.2.2.5.4.9, provided a manufacturer is in the possession of an initial design type approval. In such a case, the manufacturer's quality system according to 6.2.2.5.3 shall have been approved during the initial design type approval and shall be applicable for the new design.
- 6.2.2.5.4.8 The application shall include:
- .1 the name and address of the manufacturer and in addition, if the application is submitted by an authorized representative, its name and address;
  - .2 details of any refusal of approval of a similar application by any other competent authority;
  - .3 evidence that initial design type approval has been granted; and
  - .4 the technical documentation, as described in 6.2.2.5.4.3.8.

*Procedure for design type approval*

- 6.2.2.5.4.9 The inspection body shall:
- .1 examine the technical documentation to verify that:
    - .1 the design is in accordance with the relevant provisions of the standard, and
    - .2 the prototype lot has been manufactured in conformity with the technical documentation and is representative of the design;

- .2 verify that the production inspections have been carried out as required in accordance with 6.2.2.5.5;
- .3 select pressure receptacles from a prototype production lot and supervise the tests of these pressure receptacles as required for design type approval;
- .4 perform or have performed the examinations and tests specified in the pressure receptacle standard to determine that:
  - .1 the standard has been applied and fulfilled, and
  - .2 the procedures adopted by the manufacturer meet the requirements of the standard; and
- .5 ensure that the various type approval examinations and tests are correctly and competently carried out.

After prototype testing has been carried out with satisfactory results and all applicable requirements of 6.2.2.5.4 have been satisfied, a Design Type Approval Certificate shall be issued which shall include the name and address of the manufacturer, results and conclusions of the examination, and the necessary data for identification of the design type.

If the manufacturer is denied a design type approval, the competent authority shall provide written detailed reasons for such denial.

#### 6.2.2.5.4.10 *Modifications to approved design types*

The manufacturer shall either:

- (a) inform the issuing competent authority of modifications to the approved design type, where such modifications do not constitute a new design, as specified in the pressure receptacle standard; or
- (b) request a subsequent design type approval where such modifications constitute a new design according to the relevant pressure receptacle standard. This additional approval shall be given in the form of an amendment to the original design type approval certificate.

6.2.2.5.4.11 Upon request, the competent authority shall communicate to any other competent authority information concerning design type approval, modifications of approvals, and withdrawn approvals.

#### 6.2.2.5.5 *Production inspection and certification*

An inspection body, or its delegate, shall carry out the inspection and certification of each pressure receptacle. The inspection body selected by the manufacturer for inspection and testing during production may be different from the inspection body used for the design type approval testing.

Where it can be demonstrated to the satisfaction of the inspection body that the manufacturer has trained and competent inspectors, independent of the manufacturing operations, inspection may be performed by those inspectors. In such a case, the manufacturer shall maintain training records of the inspectors.

The inspection body shall verify that the inspections by the manufacturer and tests performed on those pressure receptacles fully conform to the standard and the provisions of this Code. Should non-conformance in conjunction with this inspection and testing be determined, the permission to have inspection performed by the manufacturer's inspectors may be withdrawn.

The manufacturer shall, after approval by the inspection body, make a declaration of conformity with the certified design type. The application of the pressure receptacle certification marking shall be considered a declaration that the pressure receptacle complies with the applicable pressure receptacle standards and the requirements of this conformity assessment system and with the provisions of this Code. The inspection body shall affix or delegate the manufacturer to affix the pressure receptacle certification marking and the registered mark of the inspection body to each approved pressure receptacle.

A certificate of compliance, signed by the inspection body and the manufacturer, shall be issued before the pressure receptacles are filled.

#### 6.2.2.5.6 *Records*

Design type approval and certificate of compliance records shall be retained by the manufacturer and the inspection body for not less than 20 years.

#### 6.2.2.6 *Approval system for periodic inspection and testing of pressure receptacles*

##### 6.2.2.6.1 *Definitions*

For the purposes of this section:

*Approval system* means a system for competent authority approval of a body performing periodic inspection and testing of pressure receptacles (hereinafter referred to as "periodic inspection and testing body"), including approval of that body's quality system.

Part 6 – Construction and testing of packagings, IBCs, etc.

---

6.2.2.6.2 **General provisions**

*Competent authority*

6.2.2.6.2.1 The competent authority shall establish an approval system for the purpose of ensuring that the periodic inspection and testing of pressure receptacles conform to the provisions of this Code. In instances where the competent authority that approves a body performing periodic inspection and testing of a pressure receptacle is not the competent authority of the country approving the manufacture of the pressure receptacle, the marks of the approval country of periodic inspection and testing shall be indicated in the pressure receptacle marking (see 6.2.2.7). The competent authority of the country of approval for the periodic inspection and testing shall supply, upon request, evidence demonstrating compliance with this approval system, including the records of the periodic inspection and testing, to its counterpart in a country of use. The competent authority of the country of approval may terminate the Approval Certificate referred to in 6.2.2.6.4.1, upon evidence demonstrating non-compliance with the approval system.

6.2.2.6.2.2 The competent authority may delegate its functions in this approval system, in whole or in part.

6.2.2.6.2.3 The competent authority shall ensure that a current list of approved periodic inspection and testing bodies and their identity marks is available.

*Periodic inspection and testing body*

6.2.2.6.2.4 The periodic inspection and testing body shall be approved by the competent authority and shall:

- .1 have a staff with an organizational structure, capable, trained, competent, and skilled, satisfactorily to perform its technical functions;
- .2 have access to suitable and adequate facilities and equipment;
- .3 operate in an impartial manner and be free from any influence which could prevent it from doing so;
- .4 ensure commercial confidentiality;
- .5 maintain clear demarcation between actual periodic inspection and testing body functions and unrelated functions;
- .6 operate a documented quality system in accordance with 6.2.2.6.3;
- .7 apply for approval in accordance with 6.2.2.6.4;
- .8 ensure that the periodic inspections and tests are performed in accordance with 6.2.2.6.5; and
- .9 maintain an effective and appropriate report and record system in accordance with 6.2.2.6.6.

6.2.2.6.3 **Quality system and audit of the periodic inspection and testing body**

6.2.2.6.3.1 *Quality system.* The quality system shall contain all the elements, requirements, and provisions adopted by the periodic inspection and testing body. It shall be documented in a systematic and orderly manner in the form of written policies, procedures, and instructions. The quality system shall include:

- .1 a description of the organizational structure and responsibilities;
- .2 the relevant inspection and test, quality control, quality assurance, and process operation instructions that will be used;
- .3 quality records, such as inspection reports, test data, calibration data and certificates;
- .4 management reviews to ensure the effective operation of the quality system arising from the audits performed in accordance with 6.2.2.6.3.2;
- .5 a process for control of documents and their revision;
- .6 a means for control of non-conforming pressure receptacles; and
- .7 training programmes and qualification procedures for relevant personnel.

6.2.2.6.3.2 *Audit.* The periodic inspection and testing body and its quality system shall be audited in order to determine whether it meets the requirements of this Code to the satisfaction of the competent authority. An audit shall be conducted as part of the initial approval process (see 6.2.2.6.4.3). An audit may be required as part of the process to modify an approval (see 6.2.2.6.4.6). Periodic audits shall be conducted, to the satisfaction of the competent authority, to ensure that the periodic inspection and testing body continues to meet the provisions of this Code. The periodic inspection and testing body shall be notified of the results of any audit. The notification shall contain the conclusions of the audit and any corrective actions required.

6.2.2.6.3.3 *Maintenance of the quality system.* The periodic inspection and testing body shall maintain the quality system as approved in order that it remains adequate and efficient. The periodic inspection and testing body shall notify the competent authority that approved the quality system of any intended changes, in accordance with the process for modification of an approval in 6.2.2.6.4.6.

**6.2.2.6.4 Approval process for periodic inspection and testing bodies**

*Initial approval*

- 6.2.2.6.4.1** A body desiring to perform periodic inspection and testing of pressure receptacles in accordance with a pressure receptacle standard and with this Code shall apply for, obtain, and retain an Approval Certificate issued by the competent authority. This written approval shall, on request, be submitted to the competent authority of a country of use.
- 6.2.2.6.4.2** An application shall be made for each periodic inspection and testing body and shall include:
- .1 the name and address of the periodic inspection and testing body and, if the application is submitted by an authorized representative, its name and address;
  - .2 the address of each facility performing periodic inspection and testing;
  - .3 the name and title of the person(s) responsible for the quality system;
  - .4 the designation of the pressure receptacles, the periodic inspection and test methods, and the relevant pressure receptacle standards met by the quality system;
  - .5 documentation on each facility, the equipment, and the quality system as specified under 6.2.2.6.3.1;
  - .6 the qualifications and training records of the periodic inspection and test personnel; and
  - .7 details of any refusal of approval of a similar application by any other competent authority.
- 6.2.2.6.4.3** The competent authority shall:
- .1 examine the documentation to verify that the procedures are in accordance with the requirements of the relevant pressure receptacle standards and of this Code; and
  - .2 conduct an audit in accordance with 6.2.2.6.3.2 to verify that the inspections and tests are carried out as required by the relevant pressure receptacle standards and by this Code, to the satisfaction of the competent authority.
- 6.2.2.6.4.4** After the audit has been carried out with satisfactory results and all applicable requirements of 6.2.2.6.4 have been satisfied, an Approval Certificate shall be issued. It shall include the name of the periodic inspection and testing body, the registered mark, the address of each facility, and the necessary data for identification of its approved activities (e.g., designation of pressure receptacles, periodic inspection and test method and pressure receptacle standards).
- 6.2.2.6.4.5** If the periodic inspection and testing body is denied approval, the competent authority shall provide written detailed reasons for such denial.

*Modifications to periodic inspection and testing body approvals*

- 6.2.2.6.4.6** Following approval, the periodic inspection and testing body shall notify the issuing competent authority of any modifications to the information submitted under 6.2.2.6.4.2 relating to the initial approval. The modifications shall be evaluated in order to determine whether the requirements of the relevant pressure receptacle standards and of this Code will be satisfied. An audit in accordance with 6.2.2.6.3.2 may be required. The competent authority shall accept or reject these modifications in writing, and an amended Approval Certificate shall be issued as necessary.
- 6.2.2.6.4.7** Upon request, the competent authority shall communicate to any other competent authority, information concerning initial approvals, modifications of approvals, and withdrawn approvals.

**6.2.2.6.5 Periodic inspection and test and certification**

The application of the periodic inspection and test marking to a pressure receptacle shall be considered a declaration that the pressure receptacle complies with the applicable pressure receptacle standards and with the provisions of this Code. The periodic inspection and testing body shall affix the periodic inspection and test marking, including its registered mark, to each approved pressure receptacle (see 6.2.2.7.7). A record certifying that a pressure receptacle has passed the periodic inspection and test shall be issued by the periodic inspection and testing body, before the pressure receptacle is filled.

**6.2.2.6.6 Records**

The periodic inspection and testing body shall retain records of pressure receptacle periodic inspection and tests (both passed and failed), including the location of the test facility, for not less than 15 years. The owner of the pressure receptacle shall retain an identical record until the next periodic inspection and test unless the pressure receptacle is permanently removed from service.

Part 6 – Construction and testing of packagings, IBCs, etc.

---

6.2.2.7 Marking of refillable UN pressure receptacles

**Note:** Marking provisions for UN metal hydride storage systems are given in 6.2.2.9.

6.2.2.7.1 Refillable UN pressure receptacles shall be marked clearly and legibly with certification, operational and manufacturing marks. These marks shall be permanently affixed (e.g., stamped, engraved, or etched) on the pressure receptacle. The marks shall be on the shoulder, top end or neck of the pressure receptacle or on a permanently affixed component of the pressure receptacle (e.g., welded collar or corrosion-resistant plate welded on the outer jacket of a closed cryogenic receptacle). Except for the UN packaging symbol, the minimum size of the marks shall be 5 mm for pressure receptacles with a diameter greater than or equal to 140 mm and 2.5 mm for pressure receptacles with a diameter less than 140 mm. The minimum size of the UN packaging symbol shall be 10 mm for pressure receptacles with a diameter greater than or equal to 140 mm and 5 mm for pressure receptacles with a diameter less than 140 mm.

6.2.2.7.2 The following certification marks shall be applied:

- (a) The UN packaging symbol



This symbol shall not be used for any purpose other than certifying that a packaging, a flexible bulk container, a portable tank or a MEGC complies with the relevant requirements in Chapter 6.1, 6.2, 6.3, 6.5, 6.6, 6.7 or 6.9;

- (b) The technical standard (e.g., ISO 9809-1) used for design, construction and testing;
- (c) The character(s) identifying the country of approval as indicated by the distinguishing signs of motor vehicles in international traffic;
- (d) The identity mark or stamp of the inspection body that is registered with the competent authority of the country authorizing the marking;
- (e) The date of the initial inspection, the year (four digits) followed by the month (two digits) separated by a slash (i.e., “/” ).

6.2.2.7.3 The following operational marks shall be applied:

- (f) The test pressure in bar, preceded by the letters “PH” and followed by the letters “BAR”;
- (g) The mass of the empty pressure receptacle including all permanently attached integral parts (e.g., neck ring, foot ring, etc.) in kilograms, followed by the letters “KG”. This mass shall not include the mass of valve, valve cap or valve guard, any coating, or porous mass for acetylene. The mass shall be expressed to three significant figures rounded up to the last digit. For cylinders of less than 1 kg, the mass shall be expressed to two significant figures rounded up to the last digit. In the case of pressure receptacles for UN 1001 acetylene, dissolved and UN 3374 acetylene, solvent free, at least one decimal shall be shown after the decimal point and two digits for pressure receptacles of less than 1 kg;
- (h) The minimum guaranteed wall thickness of the pressure receptacle in millimetres followed by the letters “MM”. This mark is not required for pressure receptacles with a water capacity less than or equal to 1 litre or for composite cylinders or for closed cryogenic receptacles;
- (i) In the case of pressure receptacles for compressed gases, UN 1001 acetylene, dissolved, and UN 3374 acetylene, solvent free, the working pressure in bar, preceded by the letters “PW”. In the case of closed cryogenic receptacles, “MAWP”;
- (j) In the case of pressure receptacles for liquefied gases and refrigerated liquefied gases, the water capacity in litres expressed to three significant figures rounded down to the last digit, followed by the letter “L”. If the value of the minimum or nominal water capacity is an integer, the digits after the decimal point may be neglected;
- (k) In the case of pressure receptacles for UN 1001 acetylene, dissolved, the total of the mass of the empty receptacle, the fittings and accessories not removed during filling, any coating, the porous material, the solvent and the saturation gas expressed to three significant figures rounded down to the last digit followed by the letters “KG”. At least one decimal shall be shown after the decimal point. For pressure receptacles of less than 1 kg, the mass shall be expressed to two significant figures rounded down to the last digit;
- (l) In the case of pressure receptacles for UN 3374 acetylene, solvent free, the total of the mass of the empty receptacle, the fittings and accessories not removed during filling, any coating and the porous material expressed to three significant figures rounded down to the last digit followed by the letters “KG”. At least one decimal shall be shown after the decimal point. For pressure receptacles of less than 1 kg, the mass shall be expressed to two significant figures rounded down to the last digit.



**Chapter 6.2 – Provisions for the construction and testing of receptacles for gases**

**6.2.2.7.4** The following manufacturing marks shall be applied:

- (m) Identification of the cylinder thread (e.g., 25E). This mark is not required for closed cryogenic receptacles;
- (n) The manufacturer's mark registered by the competent authority. When the country of manufacture is not the same as the country of approval, then the manufacturer's mark shall be preceded by the character(s) identifying the country of manufacture as indicated by the distinguishing signs of motor vehicles in international traffic. The country mark and the manufacturer's mark shall be separated by a space or slash;
- (o) The serial number assigned by the manufacturer;
- (p) In the case of steel pressure receptacles and composite pressure receptacles with steel liner intended for the transport of gases with a risk of hydrogen embrittlement, the letter "H" showing compatibility of the steel (see ISO 11114-1:1997).

**6.2.2.7.5** The above marks shall be placed in three groups.

- Manufacturing marks shall be the top grouping and shall appear consecutively in the sequence given in 6.2.2.7.4.
- The operational marks in 6.2.2.7.3 shall be the middle grouping and the test pressure (f) shall be immediately preceded by the working pressure (i) when the latter is required.
- Certification marks shall be the bottom grouping and shall appear in the sequence given in 6.2.2.7.2.

The following is an example of the markings applied to a cylinder.

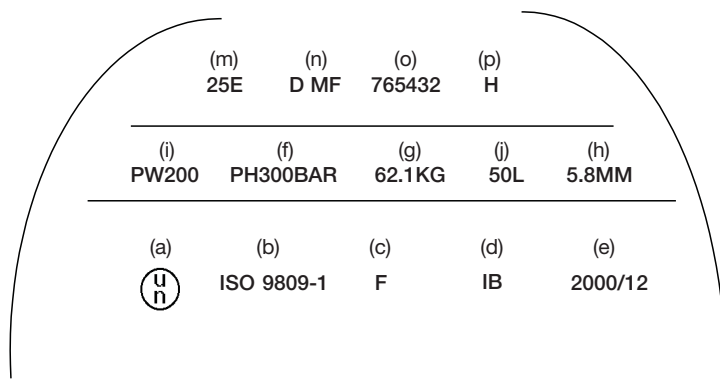

**6.2.2.7.6** Other marks are allowed in areas other than the side wall, provided they are made in low-stress areas and are not of a size and depth that will create harmful stress concentrations. In the case of closed cryogenic receptacles, such marks may be on a separate plate attached to the outer jacket. Such marks shall not conflict with required marks.

**6.2.2.7.7** In addition to the preceding marks, each refillable pressure receptacle that meets the periodic and test requirements of 6.2.2.4 shall be marked in sequence as follows:

- (a) the character(s) identifying the country authorizing the body performing the periodic inspection and test, as indicated by the distinguishing sign of motor vehicles in international traffic. This marking is not required if this body is approved by the competent authority of the country approving manufacture;
- (b) the registered mark of the body authorized by the competent authority for performing periodic inspection and test;
- (c) the date of the periodic inspection and test, the year (two digits) followed by the month (two digits) separated by a slash (i.e., "/"). Four digits may be used to indicate the year.

**6.2.2.7.8** For acetylene cylinders, with the agreement of the competent authority, the date of the most recent periodic inspection and the stamp of the body performing the periodic inspection and test may be engraved on a ring held on the cylinder by the valve. The ring shall be configured so that it can only be removed by disconnecting the valve from the cylinder.

**6.2.2.7.9** For bundles of cylinders, pressure receptacle marking provisions shall only apply to the individual cylinders of a bundle and not to any assembly structure.

Part 6 – Construction and testing of packagings, IBCs, etc.

---

6.2.2.8 Marking of non-refillable UN pressure receptacles

6.2.2.8.1 Non-refillable UN pressure receptacles shall be marked clearly and legibly with certification and gas or pressure receptacle specific marks. These marks shall be permanently affixed (e.g., stencilled, stamped, engraved, or etched) on the pressure receptacle. Except when stencilled, the marks shall be on the shoulder, top end or neck of the pressure receptacle or on a permanently affixed component of the pressure receptacle (e.g., welded collar). Except for the “UN” mark and the “DO NOT REFILL” mark, the minimum size of the marks shall be 5 mm for pressure receptacles with a diameter greater than or equal to 140 mm and 2.5 mm for pressure receptacles with a diameter less than 140 mm. The minimum size of the “UN” mark shall be 10 mm for pressure receptacles with a diameter greater than or equal to 140 mm and 5 mm for pressure receptacles with a diameter less than 140 mm. The minimum size of the “DO NOT REFILL” mark shall be 5 mm.

6.2.2.8.2 The marks listed in 6.2.2.7.2 to 6.2.2.7.4 shall be applied with the exception of (g), (h) and (m). The serial number (o) may be replaced by the batch number. In addition, the words “DO NOT REFILL” in letters of at least 5 mm in height are required.

6.2.2.8.3 The requirements of 6.2.2.7.5 shall apply.

**Note:** Non-refillable pressure receptacles may, on account of their size, substitute this marking by a label.

6.2.2.8.4 Other marks are allowed provided they are made in low-stress areas other than the side wall and are not of a size and depth that will create harmful stress concentrations. Such marks shall not conflict with required marks.

6.2.2.9 Marking of UN metal hydride storage systems

6.2.2.9.1 UN metal hydride storage systems shall be marked clearly and legibly with the marks listed below. These marks shall be permanently affixed (e.g., stamped, engraved, or etched) on the metal hydride storage system. The marks shall be on the shoulder, top end or neck of the metal hydride storage system or on a permanently affixed component of the metal hydride storage system. Except for the United Nations packaging symbol, the minimum size of the marks shall be 5 mm for metal hydride storage systems with a smallest overall dimension greater than or equal to 140 mm and 2.5 mm for metal hydride storage systems with a smallest overall dimension less than 140 mm. The minimum size of the United Nations packaging symbol shall be 10 mm for metal hydride storage systems with a smallest overall dimension greater than or equal to 140 mm and 5 mm for metal hydride storage systems with a smallest overall dimension less than 140 mm.

6.2.2.9.2 The following marks shall be applied:

- (a) The United Nations packaging symbol  ;

This symbol shall not be used for any purpose other than certifying that a packaging, a flexible bulk container, a portable tank or a MEGC complies with the relevant requirements in Chapter 6.1, 6.2, 6.3, 6.5, 6.6, 6.7 or 6.9;

- (b) “ISO 16111” (the technical standard used for design, manufacture and testing);
- (c) The character(s) identifying the country of approval as indicated by the distinguishing signs of motor vehicles in international traffic;
- (d) The identity mark or stamp of the inspection body that is registered with the competent authority of the country authorizing the marking;
- (e) The date of the initial inspection, the year (four digits) followed by the month (two digits) separated by a slash (i.e., “/”);
- (f) The test pressure of the receptacle in bar, preceded by the letters “PH” and followed by the letters “BAR”;
- (g) The rated charging pressure of the metal hydride storage system in bar, preceded by the letters “RCP” and followed by the letters “BAR”;
- (h) The manufacturer’s mark registered by the competent authority. When the country of manufacture is not the same as the country of approval, then the manufacturer’s mark shall be preceded by the character(s) identifying the country of manufacture as indicated by the distinguishing signs of motor vehicles in international traffic. The country mark and the manufacturer’s mark shall be separated by a space or slash;
- (i) The serial number assigned by the manufacturer;
- (j) In the case of steel receptacles and composite receptacles with steel liner, the letter “H” showing compatibility of the steel (see ISO 11114-1:1997); and,
- (k) In the case of metal hydride storage systems having limited life, the date of expiry, denoted by the letters “FINAL” followed by the year (four digits) followed by the month (two digits) separated by a slash (i.e., “/”).

**Chapter 6.2 – Provisions for the construction and testing of receptacles for gases**

The certification marks specified in (a) to (e) above shall appear consecutively in the sequence given. The test pressure (f) shall be immediately preceded by the rated charging pressure (g). The manufacturing marks specified in (h) to (k) above shall appear consecutively in the sequence given.

- 6.2.2.9.3** Other marks are allowed in areas other than the side wall, provided they are made in low stress areas and are not of a size and depth that will create harmful stress concentrations. Such marks shall not conflict with required marks.
- 6.2.2.9.4** In addition to the preceding marks, each metal hydride storage system that meets the periodic and test requirements of 6.2.2.4 shall be marked indicating:
- (a) The character(s) identifying the country authorizing the body performing the periodic inspection and test, as indicated by the distinguishing sign of motor vehicles in international traffic. This marking is not required if this body is approved by the competent authority of the country approving manufacture;
  - (b) The registered mark of the body authorized by the competent authority for performing periodic inspection and test;
  - (c) The date of the periodic inspection and test, the year (two digits) followed by the month (two digits) separated by a slash (i.e., “/”). Four digits may be used to indicate the year.

The above marks shall appear consecutively in the sequence given.

**6.2.3 Provisions for non-UN pressure receptacles**

- 6.2.3.1** Pressure receptacles not designed, constructed, inspected, tested and approved according to 6.2.2 shall be designed, constructed, inspected, tested and approved in accordance with a technical code recognized by the competent authority and the general provisions of 6.2.1.
- 6.2.3.2** Pressure receptacles designed, constructed, inspected, tested and approved under the provisions of this section shall not be marked with the UN packaging symbol.
- 6.2.3.3** For metallic cylinders, tubes, pressure drums bundles of cylinders and salvage pressure receptacles, the construction shall be such that the minimum burst ratio (burst pressure divided by test pressure) is:
- 1.50 for refillable pressure receptacles,
  - 2.00 for non-refillable pressure receptacles.
- 6.2.3.4** Marking shall be in accordance with the requirements of the competent authority of the country of use.
- 6.2.3.5 Salvage pressure receptacles**
- Note:** These provisions of 6.2.3.5 for salvage pressure receptacles may be applied for new salvage pressure receptacles as from 1 January 2013, unless otherwise authorized, and shall be applied for all new salvage pressure receptacles as from 1 January 2014. Salvage pressure receptacles approved in accordance with national regulations may be used with the approval of the competent authorities of the countries of use.
- 6.2.3.5.1** To permit the safe handling and disposal of the pressure receptacles transported within the salvage pressure receptacle, the design may include equipment not otherwise used for cylinders or pressure drums such as flat heads, quick opening devices and openings in the cylindrical part.
- 6.2.3.5.2** Instructions on the safe handling and use of the salvage pressure receptacle shall be clearly shown in the documentation for the application to the competent authority and shall form part of the approval certificate. In the approval certificate, the pressure receptacles authorized to be transported in a salvage pressure receptacle shall be indicated. A list of the materials of construction of all parts likely to be in contact with the dangerous goods shall also be included.
- 6.2.3.5.3** A copy of the approval certificate shall be delivered by the manufacturer to the owner of a salvage pressure receptacle.
- 6.2.3.5.4** The marking of salvage pressure receptacles according to 6.2.3 shall be determined by the competent authority in taking into account suitable marking provisions of 6.2.2.7 as appropriate. The marking shall include the water capacity and test pressure of the salvage pressure receptacle

## 6.2.4 Provisions for aerosol dispensers, small receptacles containing gas (gas cartridges) and fuel cell cartridges containing liquefied flammable gas

### 6.2.4.1 Small receptacles containing gas (gas cartridges) and fuel cell cartridges containing liquefied flammable gas

6.2.4.1.1 Each receptacle or fuel cell cartridge shall be subjected to a test performed in a hot water bath. The temperature of the bath and the duration of the test shall be such that the internal pressure reaches that which would be reached at 55°C (50°C if the liquid phase does not exceed 95% of the capacity of the receptacle or the fuel cell cartridge at 50°C). If the contents are sensitive to heat or if the receptacles or the fuel cell cartridges are made of plastics material which softens at this test temperature, the temperature of the bath shall be set at between 20°C and 30°C, but in addition one receptacle or fuel cell cartridge in 2000 shall be tested at the higher temperature.

6.2.4.1.2 No leakage or permanent deformation of a receptacle or fuel cell cartridge shall occur, except that a plastics receptacle or fuel cell cartridge may be deformed through softening provided that it does not leak.

### 6.2.4.2 Aerosol dispensers

Each filled aerosol dispenser shall be subjected to a test performed in a hot water bath or an approved water bath alternative.

#### 6.2.4.2.1 Hot water bath test

6.2.4.2.1.1 The temperature of the water bath and the duration of the test shall be such that the internal pressure reaches that which would be reached at 55°C (50°C if the liquid phase does not exceed 95% of the capacity of the aerosol dispenser at 50°C). If the contents are sensitive to heat or if the aerosol dispensers are made of plastics material which softens at this test temperature, the temperature of the bath shall be set at between 20°C and 30°C but, in addition, one aerosol dispenser in 2000 shall be tested at the higher temperature.

6.2.4.2.1.2 No leakage or permanent deformation of an aerosol dispenser may occur, except that a plastic aerosol dispenser may be deformed through softening provided that it does not leak.

#### 6.2.4.2.2 Alternative methods

With the approval of the competent authority, alternative methods which provide an equivalent level of safety may be used provided that the requirements of 6.2.4.2.2.1, 6.2.4.2.2.2 and 6.2.4.2.2.3 are met.

##### 6.2.4.2.2.1 Quality system

Aerosol dispenser fillers and component manufacturers shall have a quality system. The quality system shall implement procedures to ensure that all aerosol dispensers that leak or that are deformed are rejected and not offered for transport.

The quality system shall include:

- (a) a description of the organizational structure and responsibilities;
- (b) the relevant inspection and test, quality control, quality assurance, and process operation instructions that will be used;
- (c) quality records, such as inspection reports, test data, calibration data and certificates;
- (d) management reviews to ensure the effective operation of the quality system;
- (e) a process for control of documents and their revision;
- (f) a means for control of non-conforming aerosol dispensers;
- (g) training programmes and qualification procedures for relevant personnel; and
- (h) procedures to ensure that there is no damage to the final product.

An initial audit and periodic audits shall be conducted to the satisfaction of the competent authority. These audits shall ensure the approved system is and remains adequate and efficient. Any proposed changes to the approved system shall be notified to the competent authority in advance.

##### 6.2.4.2.2.2 Pressure and leak testing of aerosol dispensers before filling

Every empty aerosol dispenser shall be subjected to a pressure equal to or in excess of the maximum expected in the filled aerosol dispensers at 55°C (50°C if the liquid phase does not exceed 95% of the capacity of the receptacle at 50°C). This shall be at least two-thirds of the design pressure of the aerosol dispenser. If any aerosol dispenser shows evidence of leakage at a rate equal to or greater than  $3.3 \times 10^{-2}$  mbar·l·s<sup>-1</sup> at the test pressure, distortion or other defect, it shall be rejected.

6.2.4.2.2.3 *Testing of the aerosol dispensers after filling*

Prior to filling, the filler shall ensure that the crimping equipment is set appropriately and the specified propellant is used.

Each filled aerosol dispenser shall be weighed and leak tested. The leak detection equipment shall be sufficiently sensitive to detect at least a leak rate of  $2.0 \times 10^{-3}$  mbar·ℓ·s<sup>-1</sup> at 20°C.

Any filled aerosol dispenser which shows evidence of leakage, deformation or excessive mass shall be rejected.

6.2.4.3 With the approval of the competent authority, aerosols and receptacles, small, are not subject to 6.2.4.1 and 6.2.4.2, if they are required to be sterile but may be adversely affected by water bath testing, provided:

- (a) They contain a non-flammable gas and either
  - (i) contain other substances that are constituent parts of pharmaceutical products for medical, veterinary or similar purposes;
  - (ii) contain other substances used in the production process for pharmaceutical products; or
  - (iii) are used in medical, veterinary or similar applications;
- (b) An equivalent level of safety is achieved by the manufacturer's use of alternative methods for leak detection and pressure resistance, such as helium detection and water bathing a statistical sample of at least 1 in 2000 from each production batch; and
- (c) For pharmaceutical products according to (a)(i) and (iii) above, they are manufactured under the authority of a national health administration. If required by the competent authority, the principles of Good Manufacturing Practice (GMP) established by the World Health Organization (WHO)\* shall be followed.

---

\* WHO publication: "Quality assurance of pharmaceuticals. A compendium of guidelines and related materials. Volume 2: Good manufacturing practices and inspection".

## Chapter 6.3

### *Provisions for the construction and testing of packagings for class 6.2 infectious substances of category A*

#### 6.3.1 General

6.3.1.1 The provisions of this chapter apply to packagings intended for the transport of infectious substances of category A.

#### 6.3.2 Provisions for packagings

6.3.2.1 The provisions for packagings in this section are based on packagings, as specified in 6.1.4, currently used. In order to take into account progress in science and technology, there is no objection to the use of packagings having specifications different from those in this chapter provided that they are equally effective, acceptable to the competent authority and able successfully to withstand the tests described in 6.3.5. Methods of testing other than those described in the provisions of this Code are acceptable provided they are equivalent.

6.3.2.2 Packagings shall be manufactured and tested under a quality assurance programme which satisfies the competent authority in order to ensure that each packaging meets the provisions of this chapter.

**Note:** ISO 16106:2006 "Packaging – Transport packages for dangerous goods – Dangerous goods packagings, intermediate bulk containers (IBCs) and large packagings – Guidelines for the application of ISO 9001" provides acceptable guidance on procedures which may be followed.

6.3.2.3 Manufacturers and subsequent distributors of packagings shall provide information regarding procedures to be followed and a description of the types and dimensions of closures (including required gaskets) and any other components needed to ensure that packages as presented for transport are capable of passing the applicable performance tests of this chapter.

#### 6.3.3 Code for designating types of packagings

6.3.3.1 The codes for designating types of packagings are set out in 6.1.2.7.

6.3.3.2 The letters "U" or "W" may follow the packaging code. The letter "U" signifies a special packaging conforming to the provisions of 6.3.5.1.6. The letter "W" signifies that the packaging, although of the same type as indicated by the code, is manufactured to a specification different from that in 6.1.4 and is considered equivalent under the provisions of 6.3.2.1.

#### 6.3.4 Marking

**Note 1:** The marking indicates that the packaging which bears it corresponds to a successfully tested design type and that it complies with the provisions of this chapter which are related to the manufacture, but not to the use, of the packaging.

**Note 2:** The marking is intended to be of assistance to packaging manufacturers, reconditioners, packaging users, carriers and regulatory authorities.

**Note 3:** The marking does not always provide full details of the test levels, etc., and these may need to be taken further into account, e.g., by reference to a test certificate, to test reports or to a register of successfully tested packagings.

6.3.4.1 Each packaging intended for use according to the provisions of this Code shall bear markings which are durable, legible and placed in a location and of such a size relative to the packaging as to be readily visible. For packages with a gross mass of more than 30 kg, the markings or a duplicate thereof shall appear on the top or on a side of the packaging. Letters, numerals and symbols shall be at least 12 mm high, except for packagings of 30 litres or 30 kg capacity or less, when they shall be at least 6 mm in height, and for packagings of 5 litres or 5 kg or less, when they shall be of an appropriate size.

6.3.4.2 A packaging that meets the provisions of this section and of 6.3.5 shall be marked with:

- (a) the United Nations packaging symbol;



This symbol shall not be used for any purpose other than certifying that a packaging, a flexible bulk container, a portable tank or a MEGC complies with the relevant requirements in Chapter 6.1, 6.2, 6.3, 6.5, 6.6, 6.7 or 6.9.

- (b) the code designating the type of packaging according to the provisions of 6.1.2;  
(c) the text "CLASS 6.2";  
(d) the last two digits of the year of manufacture of the packaging;  
(e) the State authorizing the allocation of the mark, indicated by the distinguishing sign for motor vehicles in international traffic;  
(f) the name of the manufacturer or other identification of the packaging specified by the competent authority;  
(g) for packagings meeting the provisions of 6.3.5.1.6, the letter "U" shall be inserted immediately following the marking required in (b) above; and  
(h) each element of the marking applied in accordance with subparagraphs (a) to (g).

6.3.4.3 Marking shall be applied in the sequence shown in 6.3.4.2 (a) to (g); each element of the marking required in these subparagraphs shall be clearly separated, e.g., by a slash or space, so as to be easily identifiable. For examples, see 6.3.4.4.

Any additional markings authorized by a competent authority shall still enable the parts of the mark to be correctly identified with reference to 6.3.4.1.

6.3.4.4 Example of marking



4G/CLASS 6.2/06 as in 6.3.4.2 (a), (b), (c) and (d)  
S/SP-9989-ERIKSSON as in 6.3.4.2 (e) and (f)

## 6.3.5 Test provisions for packagings

### 6.3.5.1 Performance and frequency of tests

6.3.5.1.1 The design type of each packaging shall be tested as provided in this section in accordance with procedures established by the competent authority.

6.3.5.1.2 Each packaging design type shall successfully pass the tests prescribed in this chapter before being used. A packaging design type is defined by the design, size, material and thickness, manner of construction and packing, but may include various surface treatments. It also includes packagings which differ from the design type only in their lesser design height.

6.3.5.1.3 Tests shall be repeated on production samples at intervals established by the competent authority.

6.3.5.1.4 Tests shall also be repeated after each modification which alters the design, material or manner of construction of a packaging.

6.3.5.1.5 The competent authority may permit the selective testing of packagings that differ only in minor respects from a tested type, such as smaller sizes or lower net mass of primary receptacles; and packagings such as drums and boxes which are produced with small reductions in external dimension(s).

6.3.5.1.6 Primary receptacles of any type may be assembled within a secondary packaging and transported without testing in the rigid outer packaging under the following conditions:

- .1 the rigid outer packaging shall have been successfully tested in accordance with 6.3.5.2.2 with fragile (such as glass) primary receptacles;
- .2 the total combined gross mass of primary receptacles shall not exceed one half of the gross mass of primary receptacles used for the drop test in .1 above;
- .3 the thickness of cushioning between primary receptacles and between primary receptacles and the outside of the secondary packaging shall not be reduced below the corresponding thicknesses in the originally tested packaging; and if a single primary receptacle was used in the original test, the thickness of cushioning between primary receptacles shall not be less than the thickness of cushioning between

**Part 6 – Construction and testing of packagings, IBCs, etc.**

the outside of the secondary packaging and the primary receptacle in the original test. When either fewer or smaller primary receptacles are used (as compared to the primary receptacles used in the drop test), sufficient additional cushioning material shall be used to take up the void spaces;

- .4 the rigid outer packaging shall have successfully passed the stacking test in 6.1.5.6 while empty. The total mass of identical packages shall be based on the combined mass of packagings used in the drop test in .1 above;
- .5 for primary receptacles containing liquids, an adequate quantity of absorbent material to absorb the entire liquid content of the primary receptacles shall be present;
- .6 if the rigid outer packaging is intended to contain primary receptacles for liquids and is not leakproof, or is intended to contain primary receptacles for solids and is not sift-proof, a means of containing any liquid or solid contents in the event of leakage shall be provided in the form of a leakproof liner, plastics bag or other equally effective means of containment; and
- .7 in addition to the markings prescribed in 6.3.4.2 (a) to (f), packagings shall be marked in accordance with 6.3.4.2(g).

**6.3.5.1.7** The competent authority may at any time require proof, by tests in accordance with this section, that serially produced packagings meet the provisions of the design type tests.

**6.3.5.1.8** Provided the validity of the test results is not affected and with the approval of the competent authority, several tests may be made on one sample.

**6.3.5.2 Preparation of packagings for testing**

**6.3.5.2.1** Samples of each packaging shall be prepared as for transport except that a liquid or solid infectious substance shall be replaced by water or, where conditioning at –18°C is specified, by water containing antifreeze. Each primary receptacle shall be filled to not less than 98% of its capacity.

**Note:** The term “water” includes water/antifreeze solution with a minimum specific gravity of 0.95 for testing at –18°C.

**6.3.5.2.2 Tests and number of samples required**

**Tests required for packaging types**

Type of packaging <sup>a</sup>	Tests required							
	Primary receptacle		Water spray 6.3.5.3.6.1	Cold conditioning 6.3.5.3.6.2	Drop 6.3.5.3	Additional drop 6.3.5.3.6.3	Puncture 6.3.5.4	Stack 6.1.5.6
	Plastics	Other	Number of samples	Number of samples	Number of samples	Number of samples	Number of samples	Number of samples
Fibreboard box	x		5	5	10	Required on one sample when the packaging is intended to contain dry ice.	2	Required on three samples when testing a “U”-marked packaging as defined in 6.3.5.1.6 for specific provisions.
		x	5	0	5		2	
Fibreboard drum	x		3	3	6		2	
		x	3	0	3		2	
Plastics box	x		0	5	5		2	
		x	0	5	5		2	
Plastics drum/ jerrican	x		0	3	3		2	
		x	0	3	3		2	
Boxes of other material	x		0	5	5	2		
		x	0	0	5	2		
Drums/jerricans of other material	x		0	3	3	2		
		x	0	0	3	2		

<sup>a</sup> “Type of packaging” categorizes packagings for test purposes according to the kind of packaging and its material characteristics.

**Note 1:** In instances where a primary receptacle is made of two or more materials, the material most liable to damage determines the appropriate test.

**Note 2:** The materials of the secondary packagings are not taken into consideration when selecting the test or conditioning for the test.



*Explanation for use of the table:*

If the packaging to be tested consists of a fibreboard outer box with a plastics primary receptacle, five samples must undergo the water spray test (see 6.3.5.3.6.1) prior to dropping and another five must be conditioned to  $-18^{\circ}\text{C}$  (see 6.3.5.3.6.2) prior to dropping. If the packaging is to contain dry ice then one further single sample shall be dropped five times after conditioning in accordance with 6.3.5.3.6.3.

Packagings prepared as for transport shall be subjected to the tests in 6.3.5.3 and 6.3.5.4. For outer packagings, the headings in the table relate to fibreboard or similar materials whose performance may be rapidly affected by moisture; plastics which may embrittle at low temperature; and other materials such as metal whose performance is not affected by moisture or temperature.

**6.3.5.3 Drop test**

**6.3.5.3.1** Samples shall be subjected to free-fall drops from a height of 9 m onto a non-resilient, horizontal, flat, massive and rigid surface in conformity with 6.1.5.3.4.

**6.3.5.3.2** Where the samples are in the shape of a box, five shall be dropped, one in each of the following orientations:

- .1 flat on the base;
- .2 flat on the top;
- .3 flat on the longest side;
- .4 flat on the shortest side; and
- .5 on a corner.

**6.3.5.3.3** Where the samples are in the shape of a drum, three shall be dropped, one in each of the following orientations:

- .1 diagonally on the top chime, with the centre of gravity directly above the point of impact;
- .2 diagonally on the base chime; and
- .3 flat on the side.

**6.3.5.3.4** While the sample shall be released in the required orientation, it is accepted that, for aerodynamic reasons, the impact may not take place in that orientation.

**6.3.5.3.5** Following the appropriate drop sequence, there shall be no leakage from the primary receptacle(s), which shall remain protected by cushioning/absorbent material in the secondary packaging.

**6.3.5.3.6 *Special preparation of test sample for the drop test***

**6.3.5.3.6.1 *Fibreboard – Water spray test***

Fibreboard outer packagings: The sample shall be subjected to a water spray that simulates exposure to rainfall of approximately 5 cm per hour for at least one hour. It shall then be subjected to the test described in 6.3.5.3.1.

**6.3.5.3.6.2 *Plastics material – Cold conditioning***

Plastics primary receptacles or outer packagings: The temperature of the test sample and its contents shall be reduced to  $-18^{\circ}\text{C}$  or lower for a period of at least 24 hours and within 15 minutes of removal from that atmosphere the test sample shall be subjected to the test described in 6.3.5.3.1. Where the sample contains dry ice, the conditioning period shall be reduced to 4 hours.

**6.3.5.3.6.3 *Packagings intended to contain dry ice – Additional drop test***

Where the packaging is intended to contain dry ice, a test additional to that specified in 6.3.5.3.1 and, when appropriate, in 6.3.5.3.6.1 or 6.3.5.3.6.2 shall be carried out. One sample shall be stored so that all the dry ice dissipates and then that sample shall be dropped in one of the orientations described in 6.3.5.3.2 which shall be that most likely to result in failure of the packaging.

**6.3.5.4 Puncture test**

**6.3.5.4.1 *Packagings with a gross mass of 7 kg or less***

Samples shall be placed on a level hard surface. A cylindrical steel rod with a mass of at least 7 kg, a diameter of 38 mm and the impact end edges having a radius not exceeding 6 mm (see below) shall be dropped in a vertical free fall from a height of 1 m, measured from the impact end to the impact surface of a sample. One sample shall be placed on its base. A second sample shall be placed in an orientation perpendicular to that used for the first. In each instance, the steel rod shall be aimed to impact the primary receptacle. Following each impact, penetration of the secondary packaging is acceptable, provided that there is no leakage from the primary receptacle(s).

6.3.5.4.2 Packagings with a gross mass exceeding 7 kg

Samples shall be dropped on to the end of a cylindrical steel rod. The rod shall be set vertically in a level hard surface. It shall have a diameter of 38 mm and the edges of the upper end a radius not exceeding 6 mm (see below). The rod shall protrude from the surface a distance at least equal to that between the centre of the primary receptacle(s) and the outer surface of the outer packaging with a minimum of 200 mm. One sample shall be dropped with its top face lowermost in a vertical free fall from a height of 1 m, measured from the top of the steel rod. A second sample shall be dropped from the same height in an orientation perpendicular to that used for the first. In each instance, the packaging shall be so orientated that the steel rod would be capable of penetrating the primary receptacle(s). Following each impact, penetration of the secondary packaging is acceptable, provided that there is no leakage from the primary receptacle(s).

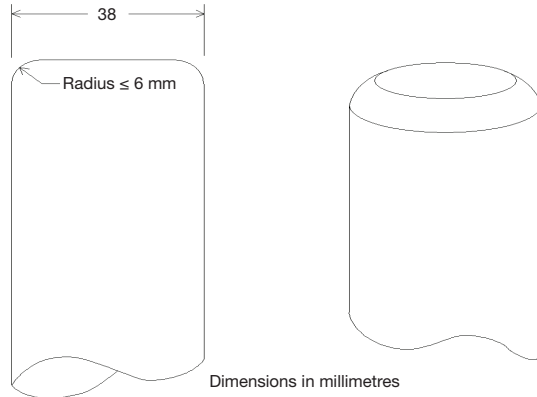

6.3.5.5 Test report

6.3.5.5.1 A written test report containing at least the following particulars shall be drawn up and shall be available to the users of the packaging:

- .1 Name and address of the test facility;
- .2 Name and address of applicant (where appropriate);
- .3 A unique test report identification;
- .4 Date of the test and of the report;
- .5 Manufacturer of the packaging;
- .6 Description of the packaging design type (e.g., dimensions, materials, closures, thickness, etc.), including method of manufacture (e.g., blow moulding) and which may include drawing(s) and/or photograph(s);
- .7 Maximum capacity;
- .8 Test contents;
- .9 Test descriptions and results;
- .10 The test report shall be signed with the name and status of the signatory.

6.3.5.5.2 The test report shall contain statements that the packaging prepared as for transport was tested in accordance with the appropriate requirements of this chapter and that the use of other packaging methods or components may render it invalid. A copy of the test report shall be available to the competent authority.

## Chapter 6.4

### *Provisions for the construction, testing and approval of packages and material of class 7*

**Note:** This chapter includes provisions which apply to the construction, testing and approval of certain packages and material only when transported by air. Whilst these provisions do not apply to packages/material transported by sea, the provisions are reproduced for information/identification purposes, since such packages/material, designed, tested and approved for air transport, may also be transported by sea.

**6.4.1** [Reserved]

#### **6.4.2 General provisions**

**6.4.2.1** The package shall be so designed in relation to its mass, volume and shape that it can be easily and safely transported. In addition, the package shall be so designed that it can be properly secured in or on the conveyance during transport.

**6.4.2.2** The design shall be such that any lifting attachments on the package will not fail when used in the intended manner and that, if failure of the attachments shall occur, the ability of the package to meet other provisions of this Code would not be impaired. The design shall take account of appropriate safety factors to cover snatch lifting.

**6.4.2.3** Attachments and any other features on the outer surface of the package which could be used to lift it shall be designed either to support its mass in accordance with the provisions of 6.4.2.2 or shall be removable or otherwise rendered incapable of being used during transport.

**6.4.2.4** As far as practicable, the packaging shall be so designed and finished that the external surfaces are free from protruding features and can be easily decontaminated.

**6.4.2.5** As far as practicable, the outer layer of the package shall be so designed as to prevent the collection and the retention of water.

**6.4.2.6** Any features added to the package at the time of transport which are not part of the package shall not reduce its safety.

**6.4.2.7** The package shall be capable of withstanding the effects of any acceleration, vibration or vibration resonance which may arise under routine conditions of transport without any deterioration in the effectiveness of the closing devices on the various receptacles or in the integrity of the package as a whole. In particular, nuts, bolts and other securing devices shall be so designed as to prevent them from becoming loose or being released unintentionally, even after repeated use.

**6.4.2.8** The materials of the packaging and any components or structures shall be physically and chemically compatible with each other and with the radioactive contents. Account shall be taken of their behaviour under irradiation.

**6.4.2.9** All valves through which the radioactive contents could escape shall be protected against unauthorized operation.

**6.4.2.10** The design of the package shall take into account ambient temperatures and pressures that are likely to be encountered in routine conditions of transport.

**6.4.2.11** For radioactive material having other dangerous properties, the package design shall take into account those properties; see 4.1.9.1.5, 2.0.3.1 and 2.0.3.2.

**6.4.2.12** Manufacturers and subsequent distributors of packagings shall provide information regarding procedures to be followed and a description of the types and dimensions of closures (including required gaskets) and any other components needed to ensure that packages as presented for transport are capable of passing the applicable performance tests of this chapter.

**6.4.3 Additional provisions for packages transported by air**

- 6.4.3.1 For packages to be transported by air, the temperature of the accessible surfaces shall not exceed 50°C at an ambient temperature of 38°C with no account taken for insolation.
- 6.4.3.2 Packages to be transported by air shall be so designed that, if they were exposed to ambient temperatures ranging from –40°C to +55°C, the integrity of containment would not be impaired.
- 6.4.3.3 Packages containing radioactive material, to be transported by air, shall be capable of withstanding, without leakage, an internal pressure which produces a pressure differential of not less than maximum normal operating pressure plus 95 kPa.

**6.4.4 Provisions for excepted packages**

An excepted package shall be designed to meet the provisions specified in 6.4.2 and, in addition, shall meet the provisions of 6.4.3 if carried by air.

**6.4.5 Provisions for industrial packages**

- 6.4.5.1 A Type IP-1 package shall be designed to meet the provisions specified in 6.4.2 and 6.4.7.2, and, in addition, shall meet the provisions of 6.4.3 if carried by air.
- 6.4.5.2 A package, to be qualified as a Type IP-2 package, shall be designed to meet the provisions for Type IP-1 as specified in 6.4.5.1 and, in addition, if it were subjected to the tests specified in 6.4.15.4 and 6.4.15.5, it would prevent:
- .1 loss or dispersal of the radioactive contents, and
  - .2 more than a 20% increase in the maximum radiation level at any external surface of the package.
- 6.4.5.3 A package, to be qualified as a Type IP-3 package, shall be designed to meet the provisions for Type IP-1 as specified in 6.4.5.1 and, in addition, the provisions specified in 6.4.7.2–6.4.7.15.
- 6.4.5.4 **Alternative provisions for Type IP-2 and Type IP-3 packages**
- 6.4.5.4.1 Packages may be used as Type IP-2 package provided that:
- .1 they satisfy the provisions for Type IP-1 specified in 6.4.5.1;
  - .2 they are designed to satisfy the provisions for packing group I or II in chapter 6.1 of this Code; and
  - .3 when subjected to the tests for UN packing group I or II in chapter 6.1, they would prevent:
    - (i) loss or dispersal of the radioactive contents; and
    - (ii) more than a 20% increase in the maximum radiation level at any external surface of the package.
- 6.4.5.4.2 Portable tanks may also be used as Type IP-2 or Type IP-3 packages provided that:
- .1 they satisfy the provisions for Type IP-1 specified in 6.4.5.1;
  - .2 they are designed to satisfy the provisions of chapter 6.7 of this Code, and are capable of withstanding a test pressure of 265 kPa; and
  - .3 they are designed so that any shielding which is provided shall be capable of withstanding the static and dynamic stresses resulting from handling and routine conditions of transport and of preventing more than a 20% increase in the maximum radiation level at any external surface of the portable tanks.
- 6.4.5.4.3 Tanks, other than portable tanks, may also be used as Type IP-2 or Type IP-3 packages for transporting LSA-I and LSA-II liquids and gases as prescribed in the table under 4.1.9.2.4, provided that:
- .1 they satisfy the provisions of 6.4.5.1;
  - .2 they are designed to satisfy the provisions prescribed in regional or national regulations for the transport of dangerous goods and are capable of withstanding a test pressure of 265 kPa; and
  - .3 they are designed so that any additional shielding which is provided shall be capable of withstanding the static and dynamic stresses resulting from handling and routine conditions of transport and of preventing more than a 20% increase in the maximum radiation level at any external surface of the tanks.
- 6.4.5.4.4 Freight containers with the characteristics of a permanent enclosure may also be used as Type IP-2 or Type IP-3 packages provided that:
- .1 the radioactive contents are restricted to solid materials;
  - .2 they satisfy the provisions for Type IP-1 specified in 6.4.5.1; and
  - .3 they are designed to conform to the standards prescribed in the International Organization for Standardization document ISO 1496-1:1990(E), "Series 1 Freight Containers – Specifications and Testing – Part 1:

General Cargo Containers” and subsequent amendments 1:1993, 2:1998, 3:2005, 4:2006 and 5:2006, excluding dimensions and ratings. They shall be designed such that, if subjected to the tests prescribed in that document and the accelerations occurring during routine conditions of transport, they would prevent:

- .1 loss or dispersal of the radioactive contents; and
- .2 more than a 20% increase in the maximum radiation level at any external surface of the package.

**6.4.5.4.5** Metal intermediate bulk containers may also be used as Type IP-2 or Type IP-3 packages provided that:

- .1 they satisfy the provisions for Type IP-1 specified in 6.4.5.1; and
- .2 they are designed to satisfy the provisions of chapter 6.5 of this Code for packing group I or II, and if they were subjected to the tests prescribed in that chapter, but with the drop test conducted in the most damaging orientation, they would prevent:
  - .1 loss or dispersal of the radioactive contents; and
  - .2 more than a 20% increase in the maximum radiation level at any external surface of the package.

## **6.4.6 Provisions for packages containing uranium hexafluoride**

**6.4.6.1** Packages designed to contain uranium hexafluoride shall meet the requirements prescribed elsewhere in this Code which pertain to the radioactive and fissile properties of the material. Except as allowed in 6.4.6.4, uranium hexafluoride in quantities of 0.1 kg or more shall also be packaged and transported in accordance with ISO 7195:2005, “Nuclear energy – Packaging of uranium hexafluoride (UF<sub>6</sub>) for transport”, and the provisions of 6.4.6.2–6.4.6.3.

**6.4.6.2** Each package designed to contain 0.1 kg or more of uranium hexafluoride shall be designed so that it would meet the following provisions:

- .1 withstand, without leakage and without unacceptable stress, as specified in ISO 7195:2005, the structural test as specified in 6.4.21;
- .2 withstand, without loss or dispersal of the uranium hexafluoride, the free drop test specified in 6.4.15.4; and
- .3 withstand, without rupture of the containment system, the thermal test specified in 6.4.17.3.

**6.4.6.3** Packages designed to contain 0.1 kg or more of uranium hexafluoride shall not be provided with pressure relief devices.

**6.4.6.4** Subject to the approval of the competent authority, packages designed to contain 0.1 kg or more of uranium hexafluoride may be transported if:

- (a) the packages are designed to international or national standards other than ISO 7195:2005, provided an equivalent level of safety is maintained;
- (b) the packages are designed to withstand, without leakage and without unacceptable stress, a test pressure of less than 2.76 MPa as specified in 6.4.21; or
- (c) for packages designed to contain 9000 kg or more of uranium hexafluoride, the packages do not meet the requirement of 6.4.6.2.3.

In all other respects, the provisions of 6.4.6.1 to 6.4.6.3 shall be satisfied.

## **6.4.7 Provisions for Type A packages**

**6.4.7.1** Type A packages shall be designed to meet the general provisions of 6.4.2, shall meet the provisions of 6.4.3 if carried by air, and shall meet the provisions of 6.4.7.2–6.4.7.17.

**6.4.7.2** The smallest overall external dimension of the package shall not be less than 10 cm.

**6.4.7.3** The outside of the package shall incorporate a feature, such as a seal, which is not readily breakable and which, while intact, will be evidence that it has not been opened.

**6.4.7.4** Any tie-down attachments on the package shall be so designed that, under normal and accident conditions of transport, the forces in those attachments shall not impair the ability of the package to meet the provisions of this Code.

**6.4.7.5** The design of the package shall take into account temperatures ranging from –40°C to +70°C for the components of the packaging. Attention shall be given to freezing temperatures for liquids and to the potential degradation of packaging materials within the given temperature range.

**6.4.7.6** The design and manufacturing techniques shall be in accordance with national or international standards, or other provisions, acceptable to the competent authority.

Part 6 – Construction and testing of packagings, IBCs, etc.

---

- 6.4.7.7 The design shall include a containment system securely closed by a positive fastening device which cannot be opened unintentionally or by a pressure which may arise within the package.
- 6.4.7.8 Special form radioactive material may be considered as a component of the containment system.
- 6.4.7.9 If the containment system forms a separate unit of the package, it shall be capable of being securely closed by a positive fastening device which is independent of any other part of the packaging.
- 6.4.7.10 The design of any component of the containment system shall take into account, where applicable, the radiolytic decomposition of liquids and other vulnerable materials and the generation of gas by chemical reaction and radiolysis.
- 6.4.7.11 The containment system shall retain its radioactive contents under a reduction of ambient pressure to 60 kPa.
- 6.4.7.12 All valves, other than pressure relief valves, shall be provided with an enclosure to retain any leakage from the valve.
- 6.4.7.13 A radiation shield which encloses a component of the package specified as a part of the containment system shall be so designed as to prevent the unintentional release of that component from the shield. Where the radiation shield and such component within it form a separate unit, the radiation shield shall be capable of being securely closed by a positive fastening device which is independent of any other packaging structure.
- 6.4.7.14 A package shall be so designed that, if it were subjected to the tests specified in 6.4.15, it would prevent:
- (a) loss or dispersal of the radioactive contents; and
  - (b) more than a 20% increase in the maximum radiation level at any external surface of the package.
- 6.4.7.15 The design of a package intended for liquid radioactive material shall make provision for ullage to accommodate variations in the temperature of the contents, dynamic effects and filling dynamics.

*Type A packages to contain liquids*

- 6.4.7.16 A Type A package designed to contain liquid radioactive material shall, in addition:
- .1 be adequate to meet the conditions specified in 6.4.7.14(a) above if the package is subjected to the tests specified in 6.4.16; and
  - .2 either
    - (i) be provided with sufficient absorbent material to absorb twice the volume of the liquid contents. Such absorbent material must be suitably positioned so as to contact the liquid in the event of leakage; or
    - (ii) be provided with a containment system composed of primary inner and secondary outer containment components designed to enclose the liquid contents completely and ensure their retention within the secondary outer containment components even if the primary inner components leak.

*Type A packages to contain gas*

- 6.4.7.17 A package designed for gases shall prevent loss or dispersal of the radioactive contents if the package were subjected to the tests specified in 6.4.16. A Type A package designed for tritium gas or for noble gases shall be excepted from this requirement.

**6.4.8 Provisions for Type B(U) packages**

- 6.4.8.1 Type B(U) packages shall be designed to meet the provisions specified in 6.4.2, shall also meet the provisions of 6.4.3 if carried by air, and shall meet the provisions of 6.4.7–6.4.8, except as specified in 6.4.7.14(a), and, in addition, the provisions specified in 6.4.8.2–6.4.8.15.
- 6.4.8.2 A package shall be so designed that, under the ambient conditions specified in 6.4.8.5 and 6.4.8.6, heat generated within the package by the radioactive contents shall not, under normal conditions of transport, as demonstrated by the tests in 6.4.15, adversely affect the package in such a way that it would fail to meet the applicable provisions for containment and shielding if left unattended for a period of one week. Particular attention shall be paid to the effects of heat, which may:
- (a) alter the arrangement, the geometrical form or the physical state of the radioactive contents or, if the radioactive material is enclosed in a can or receptacle (for example, clad fuel elements), cause the can, receptacle or radioactive material to deform or melt; or
  - (b) lessen the efficiency of the packaging through differential thermal expansion or cracking or melting of the radiation shielding material; or
  - (c) in combination with moisture, accelerate corrosion.

**Chapter 6.4 – Construction, testing and approval of packages and material of class 7**

- 6.4.8.3** A package shall be so designed that, under the ambient condition specified in 6.4.8.5 and in the absence of insulation, the temperature of the accessible surfaces of a package shall not exceed 50°C, unless the package is transported under exclusive use.
- 6.4.8.4** Except as required in 6.4.3.1 for a package transported by air, the maximum temperature of any surface readily accessible during transport of a package under exclusive use shall not exceed 85°C in the absence of insulation under the ambient conditions specified in 6.4.8.5. Account may be taken of barriers or screens intended to give protection to persons without the need for the barriers or screens being subject to any test.
- 6.4.8.5** The ambient temperature shall be assumed to be 38°C.
- 6.4.8.6** The solar insolation conditions shall be assumed to be as specified in the table hereunder.

**Insolation data**

Case	Form and location of surface	Insolation for 12 hours per day (W/m <sup>2</sup> )
1	Flat surfaces transported horizontally – downward facing	0
2	Flat surfaces transported horizontally – upward facing	800
3	Surfaces transported vertically	200*
4	Other downward-facing (not horizontal) surfaces	200*
5	All other surfaces	400*

\* Alternatively, a sine function may be used, with an absorption coefficient adopted and the effects of possible reflection from neighbouring objects neglected.

- 6.4.8.7** A package which includes thermal protection for the purpose of satisfying the provisions of the thermal test specified in 6.4.17.3 shall be so designed that such protection will remain effective if the package is subjected to the tests specified in 6.4.15 and 6.4.17.2(a) and (b) or 6.4.17.2(b) and (c), as appropriate. Any such protection on the exterior of the package shall not be rendered ineffective by ripping, cutting, skidding, abrasion or rough handling.
- 6.4.8.8** A package shall be so designed that, if it were subjected to:
- .1 the tests specified in 6.4.15, it would restrict the loss of radioactive contents to not more than  $10^{-6}A_2$  per hour; and
  - .2 the tests specified in 6.4.17.1, 6.4.17.2(b), 6.4.17.3 and 6.4.17.4 and the tests in:
    - (i) 6.4.17.2(c), when the package has a mass not greater than 500 kg, an overall density not greater than 1000 kg/m<sup>3</sup> based on the external dimensions, and radioactive contents greater than  $1000A_2$  not as special form radioactive material, or
    - (ii) 6.4.17.2(a), for all other packages, it would meet the following provisions:
      - retain sufficient shielding to ensure that the radiation level at 1 m from the surface of the package would not exceed 10 mSv/h with the maximum radioactive contents which the package is designed to contain; and
      - restrict the accumulated loss of radioactive contents in a period of one week to not more than  $10A_2$  for krypton-85 and not more than  $A_2$  for all other radionuclides.

Where mixtures of different radionuclides are present, the provisions of 2.7.2.2.4–2.7.2.2.6 shall apply except that for krypton-85 an effective  $A_2(i)$  value equal to  $10A_2$  may be used. For case (.1) above, the assessment shall take into account the external contamination limits of 4.1.9.1.2.

- 6.4.8.9** A package for radioactive contents with activity greater than  $10^5A_2$  shall be so designed that, if it were subjected to the enhanced water immersion test specified in 6.4.18, there would be no rupture of the containment system.
- 6.4.8.10** Compliance with the permitted activity release limits shall depend neither upon filters nor upon a mechanical cooling system.
- 6.4.8.11** A package shall not include a pressure relief system from the containment system which would allow the release of radioactive material to the environment under the conditions of the tests specified in 6.4.15 and 6.4.17.
- 6.4.8.12** A package shall be so designed that, if it were at the maximum normal operating pressure and it were subjected to the tests specified in 6.4.15 and 6.4.17, the level of strains in the containment system would not

## Part 6 – Construction and testing of packagings, IBCs, etc.

attain values which would adversely affect the package in such a way that it would fail to meet the applicable provisions.

- 6.4.8.13 A package shall not have a maximum normal operating pressure in excess of a gauge pressure of 700 kPa.
- 6.4.8.14 A package containing low dispersible radioactive material shall be so designed that any features added to the low dispersible radioactive material that are not part of it, or any internal components of the packaging, shall not adversely affect the performance of the low dispersible radioactive material.
- 6.4.8.15 A package shall be designed for an ambient temperature range from  $-40^{\circ}\text{C}$  to  $+38^{\circ}\text{C}$ .

**6.4.9 Provisions for Type B(M) packages**

- 6.4.9.1 Type B(M) packages shall meet the provisions for Type B(U) packages specified in 6.4.8.1, except that, for packages to be transported solely within a specified country or solely between specified countries, conditions other than those given in 6.4.7.5, 6.4.8.4, 6.4.8.5, 6.4.8.6 and 6.4.8.9–6.4.8.15 above may be assumed, with the approval of the competent authorities of these countries. Notwithstanding, the provisions for Type B(U) packages specified in 6.4.8.8–6.4.8.15 shall be met as far as practicable.
- 6.4.9.2 Intermittent venting of Type B(M) packages may be permitted during transport, provided that the operational controls for venting are acceptable to the relevant competent authorities.

**6.4.10 Provisions for Type C packages**

- 6.4.10.1 Type C packages shall be designed to meet the provisions specified in 6.4.2 and 6.4.3, and of 6.4.7.2–6.4.7.15, except as specified in 6.4.7.14, and of the provisions specified in 6.4.8.2–6.4.8.6, 6.4.8.10–6.4.8.15, and, in addition, of 6.4.10.2–6.4.10.4.
- 6.4.10.2 A package shall be capable of meeting the assessment criteria prescribed for tests in 6.4.8.8.2 and 6.4.8.12 after burial in an environment defined by a thermal conductivity of  $0.33\text{ W/(m.K)}$  and a temperature of  $38^{\circ}\text{C}$  in the steady state. Initial conditions for the assessment shall assume that any thermal insulation of the package remains intact, the package is at the maximum normal operating pressure and the ambient temperature is  $38^{\circ}\text{C}$ .
- 6.4.10.3 A package shall be so designed that, if it were at the maximum normal operating pressure and subjected to:
  - (a) the tests specified in 6.4.15, it would restrict the loss of radioactive contents to not more than  $10^{-9}A_2$  per hour; and
  - (b) the test sequences in 6.4.20.1, it would meet the following provisions:
    - (i) retain sufficient shielding to ensure that the radiation level at 1 m from the surface of the package would not exceed  $10\text{ mSv/h}$  with the maximum radioactive contents which the package is designed to contain; and
    - (ii) restrict the accumulated loss of radioactive contents in a period of 1 week to not more than  $10A_2$  for krypton-85 and not more than  $A_2$  for all other radionuclides.

Where mixtures of different radionuclides are present, the provisions of 2.7.2.2.4–2.7.2.2.6 shall apply except that for krypton-85 an effective  $A_2(i)$  value equal to  $10A_2$  may be used. For case (a) above, the assessment shall take into account the external contamination limits of 4.1.9.1.2.

- 6.4.10.4 A package shall be so designed that there will be no rupture of the containment system following performance of the enhanced water immersion test specified in 6.4.18.

**6.4.11 Provisions for packages containing fissile material**

- 6.4.11.1 Fissile material shall be transported so as to:
  - (a) maintain subcriticality during normal and accident conditions of transport; in particular, the following contingencies shall be considered:
    - (i) water leaking into or out of packages;
    - (ii) the loss of efficiency of built-in neutron absorbers or moderators;
    - (iii) rearrangement of the contents either within the package or as a result of loss from the package;
    - (iv) reduction of spaces within or between packages;
    - (v) packages becoming immersed in water or buried in snow; and
    - (vi) temperature changes; and
  - (b) meet the provisions:
    - (i) of 6.4.7.2 for packages containing fissile material;



**Chapter 6.4 – Construction, testing and approval of packages and material of class 7**

- (ii) prescribed elsewhere in this Code which pertain to the radioactive properties of the material; and
  - (iii) specified in 6.4.11.3–6.4.11.12, unless excepted by 6.4.11.2.
- 6.4.11.2** Fissile material meeting one of the provisions .1 to .4 of 2.7.2.3.5 is excepted from the requirement to be transported in packages that comply with 6.4.11.3–6.4.11.12 as well as the other provisions of this Code that apply to fissile material. Only one type of exception is allowed per consignment.
- 6.4.11.3** Where the chemical or physical form, isotopic composition, mass or concentration, moderation ratio or density, or geometric configuration is not known, the assessments of 6.4.11.7–6.4.11.12 shall be performed assuming that each parameter that is not known has the value which gives the maximum neutron multiplication consistent with the known conditions and parameters in these assessments.
- 6.4.11.4** For irradiated nuclear fuel, the assessments of 6.4.11.7–6.4.11.12 shall be based on an isotopic composition demonstrated to provide:
- (a) the maximum neutron multiplication during the irradiation history, or
  - (b) a conservative estimate of the neutron multiplication for the package assessments. After irradiation, but prior to shipment, a measurement shall be performed to confirm the conservatism of the isotopic composition.
- 6.4.11.5** The package, after being subjected to the tests specified in 6.4.15, shall:
- (a) Preserve the minimum overall outside dimensions of the package to at least 10 cm; and
  - (b) Prevent the entry of a 10 cm cube.
- 6.4.11.6** The package shall be designed for an ambient temperature range of –40°C to +38°C unless the competent authority specifies otherwise in the certificate of approval for the package design.
- 6.4.11.7** For a package in isolation, it shall be assumed that water can leak into or out of all void spaces of the package, including those within the containment system. However, if the design incorporates special features to prevent such leakage of water into or out of certain void spaces, even as a result of error, absence of leakage may be assumed in respect of those void spaces. Special features shall include the following:
- (a) Multiple high-standard water barriers, not less than two of which would remain watertight if the package were subject to the tests prescribed in 6.4.11.12(b), a high degree of quality control in the manufacture, maintenance and repair of packagings and tests to demonstrate the closure of each package before each shipment; or
  - (b) For packages containing uranium hexafluoride only, with maximum enrichment of 5 mass percent uranium-235:
    - (i) packages where, following the tests prescribed in 6.4.11.12(b), there is no physical contact between the valve and any other component of the packaging other than at its original point of attachment and where, in addition, following the test prescribed in 6.4.17.3, the valves remain leaktight; and
    - (ii) a high degree of quality control in the manufacture, maintenance and repair of packagings coupled with tests to demonstrate closure of each package before each shipment.
- 6.4.11.8** It shall be assumed that the confinement system is closely reflected by at least 20 cm of water or such greater reflection as may additionally be provided by the surrounding material of the packaging. However, when it can be demonstrated that the confinement system remains within the packaging following the tests prescribed in 6.4.11.12(b), close reflection of the package by at least 20 cm of water may be assumed in 6.4.11.9(c).
- 6.4.11.9** The package shall be subcritical under the conditions of 6.4.11.7 and 6.4.11.8 and with the package conditions that result in the maximum neutron multiplication consistent with:
- (a) routine conditions of transport (incident-free);
  - (b) the tests specified in 6.4.11.11(b);
  - (c) the tests specified in 6.4.11.12(b).
- 6.4.11.10** For packages to be transported by air:
- (a) the package shall be subcritical under conditions consistent with the Type C package tests specified in 6.4.20.1 assuming reflection by at least 20 cm of water but no water in-leakage; and
  - (b) in the assessment of 6.4.11.9, allowance shall not be made for special features of 6.4.11.7 unless, following the Type C package tests specified in 6.4.20.1 and, subsequently, the water in-leakage test of 6.4.19.3, leakage of water into or out of the void spaces is prevented.

## Part 6 – Construction and testing of packagings, IBCs, etc.

- 6.4.11.11 A number “*N*” shall be derived, such that five times “*N*” packages shall be subcritical for the arrangement and package conditions that provide the maximum neutron multiplication consistent with the following:
- there shall not be anything between the packages, and the package arrangement shall be reflected on all sides by at least 20 cm of water; and
  - the state of the packages shall be their assessed or demonstrated condition if they had been subjected to the tests specified in 6.4.15.
- 6.4.11.12 A number “*N*” shall be derived, such that two times “*N*” packages shall be subcritical for the arrangement and package conditions that provide the maximum neutron multiplication consistent with the following:
- hydrogenous moderation between packages, and the package arrangement reflected on all sides by at least 20 cm of water; and
  - the tests specified in 6.4.15 followed by whichever of the following is the more limiting:
    - the tests specified in 6.4.17.2(b) and either 6.4.17.2(c), for packages having a mass not greater than 500 kg and an overall density not greater than 1000 kg/m<sup>3</sup> based on the external dimensions, or 6.4.17.2(a), for all other packages; followed by the test specified in 6.4.17.3 and completed by the tests specified in 6.4.19.1–6.4.19.3; or
    - the test specified in 6.4.17.4; and
  - where any part of the fissile material escapes from the containment system following the tests specified in 6.4.11.12(b), it shall be assumed that fissile material escapes from each package in the array and all of the fissile material shall be arranged in the configuration and moderation that results in the maximum neutron multiplication with close reflection by at least 20 cm of water.
- 6.4.11.13 The criticality safety index (CSI) for packages containing fissile material shall be obtained by dividing the number 50 by the smaller of the two values of *N* derived in 6.4.11.11 and 6.4.11.12 (i.e.,  $CSI = 50/N$ ). The value of the criticality safety index may be zero, provided that an unlimited number of packages is subcritical (i.e., *N* is effectively equal to infinity in both cases).

## 6.4.12 Test procedures and demonstration of compliance

- 6.4.12.1 Demonstration of compliance with the performance standards required in 2.7.2.3.1.3, 2.7.2.3.1.4, 2.7.2.3.3.1, 2.7.2.3.3.2, 2.7.2.3.4.1, 2.7.2.3.4.2 and 6.4.2–6.4.11 shall be accomplished by any of the methods listed below or by a combination thereof.
- Performance of tests with specimens representing LSA-III material, or special form radioactive material, or low dispersible radioactive material or with prototypes or samples of the packaging, where the contents of the specimen or the packaging for the tests shall simulate as closely as practicable the expected range of radioactive contents and the specimen or packaging to be tested shall be prepared as presented for transport.
  - Reference to previous satisfactory demonstrations of a sufficiently similar nature.
  - Performance of tests with models of appropriate scale incorporating those features which are significant with respect to the item under investigation when engineering experience has shown results of such tests to be suitable for design purposes. When a scale model is used, the need for adjusting certain test parameters, such as penetrator diameter or compressive load, shall be taken into account.
  - Calculation, or reasoned argument, when the calculation procedures and parameters are generally agreed to be reliable or conservative.
- 6.4.12.2 After the specimen, prototype or sample has been subjected to the tests, appropriate methods of assessment shall be used to assure that the provisions of this chapter have been fulfilled in compliance with the performance and acceptance standards prescribed in this chapter (see 2.7.2.3.1.3, 2.7.2.3.1.4, 2.7.2.3.3.1, 2.7.2.3.3.2, 2.7.2.3.4.1, 2.7.2.3.4.2 and 6.4.2–6.4.11).
- 6.4.12.3 All specimens shall be inspected before testing in order to identify and record faults or damage, including the following:
- divergence from the design;
  - defects in manufacture;
  - corrosion or other deterioration; and
  - distortion of features.

The containment system of the package shall be clearly specified. The external features of the specimen shall be clearly identified so that reference may be made simply and clearly to any part of such specimen.

**6.4.13 Testing the integrity of the containment system and shielding and evaluating criticality safety**

After each of the applicable tests specified in 6.4.15–6.4.21:

- (a) faults and damage shall be identified and recorded;
- (b) it shall be determined whether the integrity of the containment system and shielding has been retained to the extent required in this chapter for the package under test; and
- (c) for packages containing fissile material, it shall be determined whether the assumptions and conditions used in the assessments required by 6.4.11.1–6.4.11.13 for one or more packages are valid.

**6.4.14 Target for drop tests**

The target for the drop tests specified in 2.7.2.3.3.5, 6.4.15.4, 6.4.16(a), 6.4.17.2 and 6.4.20.2 shall be a flat, horizontal surface of such a character that any increase in its resistance to displacement or deformation upon impact by the specimen would not significantly increase the damage to the specimen.

**6.4.15 Test for demonstrating ability to withstand normal conditions of transport**

**6.4.15.1** The tests are: the water spray test, the free drop test, the stacking test and the penetration test. Specimens of the package shall be subjected to the free drop test, the stacking test and the penetration test, preceded in each case by the water spray test. One specimen may be used for all the tests, provided that the provisions of 6.4.15.2 are fulfilled.

**6.4.15.2** The time interval between the conclusion of the water spray test and the succeeding test shall be such that the water has soaked in to the maximum extent, without appreciable drying of the exterior of the specimen. In the absence of any evidence to the contrary, this interval shall be taken to be two hours if the water spray is applied from four directions simultaneously. No time interval shall elapse, however, if the water spray is applied from each of the four directions consecutively.

**6.4.15.3** Water spray test: The specimen shall be subjected to a water spray test that simulates exposure to rainfall of approximately 5 cm per hour for at least one hour.

**6.4.15.4** Free drop test: The specimen shall drop onto the target so as to suffer maximum damage in respect of the safety features to be tested.

- (a) The height of drop measured from the lowest point of the specimen to the upper surface of the target shall be not less than the distance specified in the table hereunder for the applicable mass. The target shall be as defined in 6.4.14.
- (b) For rectangular fibreboard or wood packages not exceeding a mass of 50 kg, a separate specimen shall be subjected to a free drop onto each corner from a height of 0.3 m.
- (c) For cylindrical fibreboard packages not exceeding a mass of 100 kg, a separate specimen shall be subjected to a free drop onto each of the quarters of each rim from a height of 0.3 m.

**Free drop distance for testing packages to normal conditions of transport**

Package mass (kg)	Free drop distance (m)
Package mass < 5000	1.2
5000 ≤ Package mass < 10000	0.9
10000 ≤ Package mass < 15000	0.6
15000 ≤ Package mass	0.3

**6.4.15.5** Stacking test: Unless the shape of the packaging effectively prevents stacking, the specimen shall be subjected, for a period of 24 hours, to a compressive load equal to the greater of the following:

- (a) A total weight equal to 5 times the maximum weight of the package; and
- (b) The equivalent of 13 kPa multiplied by the vertically projected area of the package.

The load shall be applied uniformly to two opposite sides of the specimen, one of which shall be the base on which the package would typically rest.

- 6.4.15.6** Penetration test: The specimen shall be placed on a rigid, flat, horizontal surface which will not move significantly while the test is being carried out.
- (a) A bar of 3.2 cm in diameter with a hemispherical end and a mass of 6 kg shall be dropped and directed to fall, with its longitudinal axis vertical, onto the centre of the weakest part of the specimen, so that, if it penetrates sufficiently far, it will hit the containment system. The bar shall not be significantly deformed by the test performance.
  - (b) The height of drop of the bar measured from its lower end to the intended point of impact on the upper surface of the specimen shall be 1 m.

**6.4.16 Additional tests for Type A packages designed for liquids and gases**

A specimen or separate specimens shall be subjected to each of the following tests unless it can be demonstrated that one test is more severe for the specimen in question than the other, in which case one specimen shall be subjected to the more severe test.

- (a) Free drop test: The specimen shall drop onto the target so as to suffer the maximum damage in respect of containment. The height of the drop measured from the lowest part of the specimen to the upper surface of the target shall be 9 m. The target shall be as defined in 6.4.14.
- (b) Penetration test: The specimen shall be subjected to the test specified in 6.4.15.6 except that the height of drop shall be increased to 1.7 m from the 1 m specified in 6.4.15.6(b).

**6.4.17 Tests for demonstrating ability to withstand accident conditions of transport**

**6.4.17.1** The specimen shall be subjected to the cumulative effects of the tests specified in 6.4.17.2 and 6.4.17.3, in that order. Following these tests, either this specimen or a separate specimen shall be subjected to the effect(s) of the water immersion test(s) as specified in 6.4.17.4 and, if applicable, 6.4.18.

**6.4.17.2** Mechanical test: The mechanical test consists of three different drop tests. Each specimen shall be subjected to the applicable drops as specified in 6.4.8.8 or 6.4.11.12. The order in which the specimen is subjected to the drops shall be such that, on completion of the mechanical test, the specimen shall have suffered such damage as will lead to the maximum damage in the thermal test which follows.

- (a) For drop I, the specimen shall drop onto the target so as to suffer the maximum damage, and the height of the drop measured from the lowest point of the specimen to the upper surface of the target shall be 9 m. The target shall be as defined in 6.4.14.
- (b) For drop II, the specimen shall drop so as to suffer the maximum damage onto a bar rigidly mounted perpendicularly on the target. The height of the drop measured from the intended point of impact of the specimen to the upper surface of the bar shall be 1 m. The bar shall be of solid mild steel of circular section, (15.0±0.5) cm in diameter and 20 cm long unless a longer bar would cause greater damage, in which case a bar of sufficient length to cause maximum damage shall be used. The upper end of the bar shall be flat and horizontal with its edge rounded off to a radius of not more than 6 mm. The target on which the bar is mounted shall be as described in 6.4.14.
- (c) For drop III, the specimen shall be subjected to a dynamic crush test by positioning the specimen on the target so as to suffer maximum damage by the drop of a 500 kg mass from 9 m onto the specimen. The mass shall consist of a solid mild steel plate 1 m by 1 m and shall fall in a horizontal attitude. The height of the drop shall be measured from the underside of the plate to the highest point of the specimen. The target on which the specimen rests shall be as defined in 6.4.14.

**6.4.17.3** Thermal test: The specimen shall be in thermal equilibrium under conditions of an ambient temperature of 38°C, subject to the solar insolation conditions specified in the table under 6.4.8.6 and subject to the design maximum rate of internal heat generation within the package from the radioactive contents. Alternatively, any of these parameters are allowed to have different values prior to and during the test, providing due account is taken of them in the subsequent assessment of package response.

The thermal test shall then consist of:

- (a) exposure of a specimen for a period of 30 minutes to a thermal environment which provides a heat flux at least equivalent to that of a hydrocarbon fuel/air fire in sufficiently quiescent ambient conditions to give a minimum average flame emissivity coefficient of 0.9 and an average temperature of at least 800°C, fully engulfing the specimen, with a surface absorptivity coefficient of 0.8 or that value which the package may be demonstrated to possess if exposed to the fire specified, followed by;
- (b) exposure of the specimen to an ambient temperature of 38°C, subject to the solar insolation conditions specified in the table under 6.4.8.6 and subject to the design maximum rate of internal heat generation within the package by the radioactive contents, for a sufficient period to ensure that temperatures in the specimen are everywhere decreasing and/or are approaching initial steady-state conditions. Alternatively, any of these parameters are allowed to have different values following cessation of heating, providing due account is taken of them in the subsequent assessment of package response.

During and following the test, the specimen shall not be artificially cooled and any combustion of materials of the specimen shall be permitted to proceed naturally.

**6.4.17.4** Water immersion test: The specimen shall be immersed under a head of water of at least 15 m for a period of not less than eight hours in the attitude which will lead to maximum damage. For demonstration purposes, an external gauge pressure of at least 150 kPa shall be considered to meet these conditions.

**6.4.18 Enhanced water immersion test for Type B(U) and Type B(M) packages containing more than 10<sup>5</sup>A<sub>2</sub> and Type C packages**

Enhanced water immersion test: The specimen shall be immersed under a head of water of at least 200 m for a period of not less than one hour. For demonstration purposes, an external gauge pressure of at least 2 MPa shall be considered to meet these conditions.

**6.4.19 Water leakage test for packages containing fissile material**

**6.4.19.1** Packages for which water in-leakage or out-leakage to the extent which results in greatest reactivity has been assumed for purposes of assessment under 6.4.11.7–6.4.11.12 shall be excepted from the test.

**6.4.19.2** Before the specimen is subjected to the water leakage test specified below, it shall be subjected to the tests in 6.4.17.2(b), and either 6.4.17.2(a) or (c) as required by 6.4.11.12, and the test specified in 6.4.17.3.

**6.4.19.3** The specimen shall be immersed under a head of water of at least 0.9 m for a period of not less than eight hours and in the attitude for which maximum leakage is expected.

**6.4.20 Tests for Type C packages**

**6.4.20.1** Specimens shall be subjected to the effects of each of the following test sequences in the orders specified:

- (a) the tests specified in 6.4.17.2(a), 6.4.17.2(c), 6.4.20.2 and 6.4.20.3; and
- (b) the test specified in 6.4.20.4.

Separate specimens are allowed to be used for each of the sequences (a) and (b).

**6.4.20.2** Puncture/tearing test: The specimen shall be subjected to the damaging effects of a solid probe made of mild steel. The orientation of the probe to the surface of the specimen shall be as to cause maximum damage at the conclusion of the test sequence specified in 6.4.20.1(a).

- (a) The specimen, representing a package having a mass less than 250 kg, shall be placed on a target and subjected to a probe having a mass of 250 kg falling from a height of 3 m above the intended impact point. For this test, the probe shall be a 20 cm diameter cylindrical bar with the striking end forming a frustum of a right circular cone with the following dimensions: 30 cm height and 2.5 cm in diameter at the top with its edge rounded off to a radius of not more than 6 mm. The target on which the specimen is placed shall be as specified in 6.4.14.
- (b) For packages having a mass of 250 kg or more, the base of the probe shall be placed on a target and the specimen dropped onto the probe. The height of the drop, measured from the point of impact with the specimen to the upper surface of the probe, shall be 3 m. For this test, the probe shall have the same properties and dimensions as specified in (a) above, except that the length and mass of the probe shall be such as to incur maximum damage to the specimen. The target on which the base of the probe is placed shall be as specified in 6.4.14.

**6.4.20.3** Enhanced thermal test: The conditions for this test shall be as specified in 6.4.17.3, except that the exposure to the thermal environment shall be for a period of 60 minutes.

**6.4.20.4** Impact test: The specimen shall be subject to an impact on a target at a velocity of not less than 90 m/s, at such an orientation as to suffer maximum damage. The target shall be as defined in 6.4.14, except that the target surface may be at any orientation provided that the surface is normal to the specimen path.

**6.4.21 Tests for packagings designed to contain uranium hexafluoride**

Specimens that comprise or simulate packagings designed to contain 0.1 kg or more of uranium hexafluoride shall be tested hydraulically at an internal pressure of at least 1.38 MPa but, when the test pressure is less than 2.76 MPa, the design will require multilateral approval. For retesting packagings, any other equivalent non-destructive testing may be applied, subject to multilateral approval.

## **6.4.22 Approvals of package designs and materials**

- 6.4.22.1 The approval of designs for packages containing 0.1 kg or more of uranium hexafluoride requires that:
- (a) Each design that meets the provisions of 6.4.6.4 shall require multilateral approval;
  - (b) Each design that meets the provisions of 6.4.6.1 to 6.4.6.3 shall require unilateral approval by the competent authority of the country of origin of the design, unless multilateral approval is otherwise required by this Code.
- 6.4.22.2 Each Type B(U) and Type C package design will require unilateral approval, except that:
- (a) a package design for fissile material which is also subject to 6.4.22.4, 6.4.23.7 and 5.1.5.2.1 will require multilateral approval; and
  - (b) a Type B(U) package design for low dispersible radioactive material will require multilateral approval.
- 6.4.22.3 Each Type B(M) package design, including those for fissile material which are also subject to 6.4.22.4, 6.4.23.7 and 5.1.5.2.1 and those for low dispersible radioactive material, will require multilateral approval.
- 6.4.22.4 Each package design for fissile material which is not excepted according to 6.4.11.2 from the provisions that apply specifically to packages containing fissile material will require multilateral approval.
- 6.4.22.5 The design for special form radioactive material will require unilateral approval. The design for low dispersible radioactive material will require multilateral approval (see also 6.4.23.8).

## **6.4.23 Applications for approval and approvals for radioactive material transport**

- 6.4.23.1 [Reserved]
- 6.4.23.2 An application for shipment approval shall include:
- (a) the period of time, related to the shipment, for which the approval is sought;
  - (b) the actual radioactive contents, the expected modes of transport, the type of conveyance, and the probable or proposed route; and
  - (c) the details of how the precautions and administrative or operational controls referred to in the package design approval certificates issued under 5.1.5.2.1 are to be put into effect.
- 6.4.23.3 An application for approval of shipments under special arrangement shall include all the information necessary to satisfy the competent authority that the overall level of safety in transport is at least equivalent to that which would be provided if all the applicable provisions of this Code had been met. The application shall also include:
- (a) a statement of the respects in which, and of the reasons why, the shipment cannot be made in full accordance with the applicable provisions; and
  - (b) a statement of any special precautions or special administrative or operational controls which are to be employed during transport to compensate for the failure to meet the applicable provisions.
- 6.4.23.4 An application for approval of Type B(U) or Type C package design shall include:
- (a) a detailed description of the proposed radioactive contents with reference to their physical and chemical states and the nature of the radiation emitted;
  - (b) a detailed statement of the design, including complete engineering drawings and schedules of materials and methods of manufacture;
  - (c) a statement of the tests which have been done and their results, or evidence based on calculative methods or other evidence that the design is adequate to meet the applicable provisions;
  - (d) the proposed operating and maintenance instructions for the use of the packaging;
  - (e) if the package is designed to have a maximum normal operating pressure in excess of 100 kPa gauge, a specification of the materials of manufacture of the containment system, the samples to be taken, and the tests to be made;
  - (f) where the proposed radioactive contents are irradiated fuel, a statement and a justification of any assumption in the safety analysis relating to the characteristics of the fuel and a description of any pre-shipment measurement required by 6.4.11.4(b);
  - (g) any special stowage provisions necessary to ensure the safe dissipation of heat from the package, considering the various modes of transport to be used and type of conveyance or freight container;
  - (h) a reproducible illustration, not larger than 21 cm by 30 cm, showing the make-up of the package; and
  - (i) a specification of the applicable quality-assurance programme as required in 1.5.3.1.

**Chapter 6.4 – Construction, testing and approval of packages and material of class 7**

- 6.4.23.5** An application for approval of a Type B(M) package design shall include, in addition to the information required in 6.4.23.4 for Type B(U) packages:
- (a) a list of the provisions specified in 6.4.7.5, 6.4.8.4, 6.4.8.5, 6.4.8.6 and 6.4.8.9–6.4.8.15 with which the package does not conform;
  - (b) any proposed supplementary operational controls to be applied during transport not regularly provided for in this Code, but which are necessary to ensure the safety of the package or to compensate for the deficiencies listed in (a) above;
  - (c) a statement relative to any restrictions on the mode of transport and to any special loading, carriage, unloading or handling procedures; and
  - (d) the range of ambient conditions (temperature, solar radiation) which are expected to be encountered during transport and which have been taken into account in the design.
- 6.4.23.6** The application for approval of designs for packages containing 0.1 kg or more of uranium hexafluoride shall include all information necessary to satisfy the competent authority that the design meets the provisions of 6.4.6.1, and a specification of the applicable quality-assurance programme as required by 1.5.3.1.
- 6.4.23.7** An application for a fissile package approval shall include all information necessary to satisfy the competent authority that the design meets the provisions of 6.4.11.1, and a specification of the applicable quality-assurance programme as required in 1.5.3.1.
- 6.4.23.8** An application for approval of design for special form radioactive material and design for low dispersible radioactive material shall include:
- (a) a detailed description of the radioactive material or, if a capsule, the contents; particular reference shall be made to both physical and chemical states;
  - (b) a detailed statement of the design of any capsule to be used;
  - (c) a statement of the tests which have been done and their results, or evidence based on calculative methods to show that the radioactive material is capable of meeting the performance standards, or other evidence that the special form radioactive material or low dispersible radioactive material meets the applicable provisions of this Code;
  - (d) a specification of the applicable quality-assurance programme as required in 1.5.3.1; and
  - (e) any proposed pre-shipment actions for use in the consignment of special form radioactive material or low dispersible radioactive material.
- 6.4.23.9** Each approval certificate issued by a competent authority shall be assigned an identification mark. The mark shall be of the following generalized type:
- VRI/number/type code**
- (a) Except as provided in 6.4.23.10(b), “VRI” represents the international vehicle registration identification code of the country issuing the certificate.\*
  - (b) The number shall be assigned by the competent authority, and shall be unique and specific with regard to the particular design or shipment. The shipment approval identification mark shall be clearly related to the design approval identification mark.
  - (c) The following type codes shall be used, in the order listed, to indicate the types of approval certificates issued:
    - AF Type A package design for fissile material
    - B(U) Type B(U) package design (“B(U)F” if for fissile material)
    - B(M) Type B(M) package design (“B(M)F” if for fissile material)
    - C Type C package design (“CF” if for fissile material)
    - IF industrial package design for fissile material
    - S special form radioactive material
    - LD low dispersible radioactive material
    - T shipment
    - X special arrangement.
- In the case of package designs for non-fissile or fissile excepted uranium hexafluoride, where none of the above codes apply, then the following type codes shall be used:
- H(U) unilateral approval
  - H(M) multilateral approval

\* See Convention on Road Traffic, Vienna, 1968.

Part 6 – Construction and testing of packagings, IBCs, etc.

---

- (d) For package design and special form radioactive material approval certificates, other than those issued under the provisions of 6.4.24.2–6.4.24.4, and for low dispersible radioactive material approval certificates, the symbols “-96” shall be added to the type code.

6.4.23.10 These type codes shall be applied as follows:

- (a) Each certificate and each package shall bear the appropriate identification mark, comprising the symbols prescribed in 6.4.23.9(a), (b), (c) and (d) above, except that, for packages, only the applicable design type codes, including, if applicable, the symbols ‘-96’, shall appear following the second stroke; that is, the ‘T’ or ‘X’ shall not appear in the identification marking on the package. Where the design approval and shipment approval are combined, the applicable type codes do not need to be repeated. For example:

**A/132/B(M)F-96:** A Type B(M) package design approved for fissile material, requiring multilateral approval, for which the competent authority of Austria has assigned the design number 132 (to be marked on both the package and on the package design approval certificate);

**A/132/B(M)F-96T:** The shipment approval issued for a package bearing the identification mark elaborated above (to be marked on the certificate only);

**A/137/X:** A special arrangement approval issued by the competent authority of Austria, to which the number 137 has been assigned (to be marked on the certificate only);

**A/139/IF-96:** An Industrial package design for fissile material approved by the competent authority of Austria, to which package design number 139 has been assigned (to be marked on both the package and on the package design approval certificate); and

**A/145/H(U)-96:** A package design for fissile excepted uranium hexafluoride approved by the competent authority of Austria, to which package design number 145 has been assigned (to be marked on both the package and on the package design approval certificate);

- (b) Where multilateral approval is effected by validation according to 6.4.23.16, only the identification mark issued by the country of origin of the design or shipment shall be used. Where multilateral approval is effected by issue of certificates by successive countries, each certificate shall bear the appropriate identification mark and the package whose design was so approved shall bear all appropriate identification marks. For example:

**A/132/B(M)F-96**

**CH/28/B(M)F-96**

would be the identification mark of a package which was originally approved by Austria and was subsequently approved, by separate certificate, by Switzerland. Additional identification marks would be tabulated in a similar manner on the package;

- (c) The revision of a certificate shall be indicated by a parenthetical expression following the identification mark on the certificate. For example, **A/132/B(M)F-96(Rev.2)** would indicate revision 2 of the Austrian package design approval certificate; or **A/132/B(M)F-96(Rev.0)** would indicate the original issuance of the Austrian package design approval certificate. For original issuances, the parenthetical entry is optional and other words such as ‘original issuance’ may also be used in place of ‘Rev.0’. Certificate revision numbers may only be issued by the country issuing the original approval certificate;
- (d) Additional symbols (as may be necessitated by national provisions) may be added in parentheses to the end of the identification mark. For example, **A/132/B(M)F-96(SP503)**; and
- (e) It is not necessary to alter the identification mark on the packaging each time that a revision to the design certificate is made. Such re-marking shall be required only in those cases where the revision to the package design certificate involves a change in the letter type codes for the package design following the second stroke.

6.4.23.11 Each approval certificate issued by a competent authority for special form radioactive material or low dispersible radioactive material shall include the following information:

- (a) Type of certificate.
- (b) The competent authority identification mark.
- (c) The issue date and an expiry date.
- (d) List of applicable national and international regulations, including the edition of the IAEA Regulations for the Safe Transport of Radioactive Material under which the special form radioactive material or low dispersible radioactive material is approved.
- (e) The identification of the special form radioactive material or low dispersible radioactive material.
- (f) A description of the special form radioactive material or low dispersible radioactive material.
- (g) Design specifications for the special form radioactive material or low dispersible radioactive material, which may include references to drawings.
- (h) A specification of the radioactive contents which includes the activities involved and which may include the physical and chemical form.



- (i) A specification of the applicable quality-assurance programme as required in 1.5.3.1.
- (j) Reference to information provided by the applicant relating to specific actions to be taken prior to shipment.
- (k) If deemed appropriate by the competent authority, reference to the identity of the applicant.
- (l) Signature and identification of the certifying official.

**6.4.23.12** Each approval certificate issued by a competent authority for a special arrangement shall include the following information:

- (a) Type of certificate.
- (b) The competent authority identification mark.
- (c) The issue date and an expiry date.
- (d) Mode(s) of transport.
- (e) Any restrictions on the modes of transport, type of conveyance, freight container, and any necessary routeing instructions.
- (f) List of applicable national and international regulations, including the edition of the IAEA Regulations for the Safe Transport of Radioactive Material under which the special arrangement is approved.
- (g) The following statement: "This certificate does not relieve the consignor from compliance with any requirement of the government of any country through or into which the package will be transported."
- (h) References to certificates for alternative radioactive contents, other competent authority validation, or additional technical data or information, as deemed appropriate by the competent authority.
- (i) Description of the packaging by a reference to the drawings or a specification of the design. If deemed appropriate by the competent authority, a reproducible illustration, not larger than 21 cm by 30 cm, showing the make-up of the package shall also be provided, accompanied by a brief description of the packaging, including materials of manufacture, gross mass, general outside dimensions and appearance.
- (j) A specification of the authorized radioactive contents, including any restrictions on the radioactive contents which might not be obvious from the nature of the packaging. This shall include the physical and chemical forms, the activities involved (including those of the various isotopes, if appropriate), amounts in grams (for fissile material or for each fissile nuclide when appropriate), and whether special form radioactive material or low dispersible radioactive material, if applicable.
- (k) Additionally, for packages containing fissile material:
  - (i) a detailed description of the authorized radioactive contents;
  - (ii) the value of the criticality safety index;
  - (iii) reference to the documentation that demonstrates the criticality safety of the contents;
  - (iv) any special features, on the basis of which the absence of water from certain void spaces has been assumed in the criticality assessment;
  - (v) any allowance (based on 6.4.11.4(b)) for a change in neutron multiplication assumed in the criticality assessment as a result of actual irradiation experience; and
  - (vi) the ambient temperature range for which the special arrangement has been approved.
- (l) A detailed listing of any supplementary operational controls required for preparation, loading, carriage, unloading and handling of the consignment, including any special stowage provisions for the safe dissipation of heat.
- (m) If deemed appropriate by the competent authority, reasons for the special arrangement.
- (n) Description of the compensatory measures to be applied as a result of the shipment being under special arrangement.
- (o) Reference to information provided by the applicant relating to the use of the packaging or specific actions to be taken prior to the shipment.
- (p) A statement regarding the ambient conditions assumed for purposes of design if these are not in accordance with those specified in 6.4.8.5, 6.4.8.6 and 6.4.8.15, as applicable.
- (q) Any emergency arrangements deemed necessary by the competent authority.
- (r) A specification of the applicable quality-assurance programme as required in 1.5.3.1.
- (s) If deemed appropriate by the competent authority, reference to the identity of the applicant and to the identity of the carrier.
- (t) Signature and identification of the certifying official.

*Part 6 – Construction and testing of packagings, IBCs, etc.*

---

- 6.4.23.13** Each approval certificate for a shipment issued by a competent authority shall include the following information:
- (a) Type of certificate.
  - (b) The competent authority identification mark(s).
  - (c) The issue date and an expiry date.
  - (d) List of applicable national and international regulations, including the edition of the IAEA Regulations for the Safe Transport of Radioactive Material under which the shipment is approved.
  - (e) Any restrictions on the modes of transport, type of conveyance, freight container, and any necessary routing instructions.
  - (f) The following statement: “This certificate does not relieve the consignor from compliance with any requirement of the government of any country through or into which the package will be transported.”
  - (g) A detailed listing of any supplementary operational controls required for preparation, loading, carriage, unloading and handling of the consignment, including any special stowage provisions for the safe dissipation of heat or maintenance of criticality safety.
  - (h) Reference to information provided by the applicant relating to specific actions to be taken prior to shipment.
  - (i) Reference to the applicable design approval certificate(s).
  - (j) A specification of the actual radioactive contents, including any restrictions on the radioactive contents which might not be obvious from the nature of the packaging. This shall include the physical and chemical forms, the total activities involved (including those of the various isotopes, if appropriate), amounts in grams (for fissile material or for each fissile nuclide when appropriate), and whether special form radioactive material or low dispersible radioactive material, if applicable.
  - (k) Any emergency arrangements deemed necessary by the competent authority.
  - (l) A specification of the applicable quality-assurance programme as required in 1.5.3.1.
  - (m) If deemed appropriate by the competent authority, reference to the identity of the applicant.
  - (n) Signature and identification of the certifying official.
- 6.4.23.14** Each approval certificate of the design of a package issued by a competent authority shall include the following information:
- (a) Type of certificate.
  - (b) The competent authority identification mark.
  - (c) The issue date and an expiry date.
  - (d) Any restriction on the modes of transport, if appropriate.
  - (e) List of applicable national and international regulations, including the edition of the IAEA Regulations for the Safe Transport of Radioactive Material under which the design is approved.
  - (f) The following statement: “This certificate does not relieve the consignor from compliance with any requirement of the government of any country through or into which the package will be transported.”
  - (g) References to certificates for alternative radioactive contents, other competent authority validation, or additional technical data or information, as deemed appropriate by the competent authority.
  - (h) A statement authorizing shipment where shipment approval is required under 5.1.5.1.2, if deemed appropriate.
  - (i) Identification of the packaging.
  - (j) Description of the packaging by a reference to the drawings or specification of the design. If deemed appropriate by the competent authority, a reproducible illustration, not larger than 21 cm by 30 cm, showing the make-up of the package shall also be provided, accompanied by a brief description of the packaging, including materials of manufacture, gross mass, general outside dimensions and appearance.
  - (k) Specification of the design by reference to the drawings.
  - (l) A specification of the authorized radioactive content, including any restrictions on the radioactive contents which might not be obvious from the nature of the packaging. This shall include the physical and chemical forms, the activities involved (including those of the various isotopes, if appropriate), amounts in grams (for fissile material or for each fissile nuclide when appropriate), and whether special form radioactive material or low dispersible radioactive material, if applicable.
  - (m) A description of the containment system;
  - (n) Additionally, for packages containing fissile material:
    - (i) a detailed description of the authorized radioactive contents;
    - (ii) a description of the confinement system;
    - (iii) the value of the criticality safety index;

- (iv) reference to the documentation that demonstrates the criticality safety of the contents;
  - (v) any special features, on the basis of which the absence of water from certain void spaces has been assumed in the criticality assessment;
  - (vi) any allowance (based on 6.4.11.4(b)) for a change in neutron multiplication assumed in the criticality assessment as a result of actual irradiation experience; and
  - (vii) the ambient temperature range for which the package design has been approved.
- (o) For Type B(M) packages, a statement specifying those prescriptions of 6.4.7.5, 6.4.8.4, 6.4.8.5, 6.4.8.6 and 6.4.8.9–6.4.8.15 with which the package does not conform and any amplifying information which may be useful to other competent authorities.
  - (p) For packages containing more than 0.1 kg of uranium hexafluoride, a statement specifying those prescriptions of 6.4.6.4 that apply, if any, and any amplifying information which may be useful to other competent authorities.
  - (q) A detailed listing of any supplementary operational controls required for preparation, loading, carriage, unloading and handling of the consignment, including any special stowage provisions for the safe dissipation of heat.
  - (r) Reference to information provided by the applicant relating to the use of the packaging or specific actions to be taken prior to shipment.
  - (s) A statement regarding the ambient conditions assumed for purposes of design if these are not in accordance with those specified in 6.4.8.5, 6.4.8.6 and 6.4.8.15, as applicable.
  - (t) A specification of the applicable quality-assurance programme as required in 1.5.3.1.
  - (u) Any emergency arrangements deemed necessary by the competent authority.
  - (v) If deemed appropriate by the competent authority, reference to the identity of the applicant.
  - (w) Signature and identification of the certifying official.

**6.4.23.15** The competent authority shall be informed of the serial number of each packaging manufactured to a design approved under 6.4.22.2, 6.4.22.3, 6.4.22.4, 6.4.24.2 and 6.4.24.3.

**6.4.23.16** Multilateral approval may be by validation of the original certificate issued by the competent authority of the country of origin of the design or shipment. Such validation may take the form of an endorsement on the original certificate or the issuance of a separate endorsement, annex, supplement, etc., by the competent authority of the country through or into which the shipment is made.

## **6.4.24 Transitional measures for class 7**

### **Packages not requiring competent authority approval of design under the 1985 and 1985 (as amended 1990) editions of IAEA Safety Series No. 6**

**6.4.24.1** Excepted packages, Type IP-1, Type IP-2 and Type IP-3 and Type A packages that did not require approval of design by the competent authority and which meet the provisions of the 1985 or 1985 (as amended 1990) editions of IAEA Regulations for the Safe Transport of Radioactive Material (IAEA Safety Series No. 6) may continue to be used, subject to the mandatory programme of quality assurance in accordance with the provisions of 1.5.3.1 and the activity limits and material restrictions of 2.7.2.2, 2.7.2.4.1, 2.7.2.4.4, 2.7.2.4.5, 2.7.2.4.6 and 4.1.9.3. Any packaging modified, unless to improve safety, or manufactured after 31 December 2003 shall meet the provisions of this Code in full. Packages prepared for transport not later than 31 December 2003 under the 1985 or 1985 (as amended 1990) editions of IAEA Safety Series No. 6 may continue in transport. Packages prepared for transport after this date shall meet the provisions of this Code in full.

### **Packages approved under the 1973, 1973 (as amended), 1985 and 1985 (as amended 1990) editions of IAEA Safety Series No. 6**

**6.4.24.2** Packagings manufactured to a package design approved by the competent authority under the provisions of the 1973 or 1973 (as amended) editions of IAEA Safety Series No. 6 may continue to be used, subject to: multilateral approval of package design; the mandatory programme of quality assurance in accordance with the applicable provisions of 1.5.3.1; the activity limits and material restrictions of 2.7.2.2, 2.7.2.4.1, 2.7.2.4.4, 2.7.2.4.5, 2.7.2.4.6 and 4.1.9.3; and, for a package containing fissile material and transported by air, the requirement of 6.4.11.10 shall be met. No new manufacture of such packaging shall be permitted to commence. Changes in the design of the packaging or in the nature or quantity of the authorized radioactive contents which, as determined by the competent authority, would significantly affect safety shall require that the provisions of this Code be met in full. A serial number according to the provision of 5.2.1.5.5 shall be assigned to and marked on the outside of each packaging.

Part 6 – Construction and testing of packagings, IBCs, etc.

---

6.4.24.3 Packagings manufactured to a package design approved by the competent authority under the provisions of the 1985 or 1985 (as amended 1990) editions of IAEA Safety Series No. 6 may continue to be used, subject to: the multilateral approval of package design; the mandatory programme of quality assurance in accordance with the provisions of 1.5.3.1; the activity limits and material restrictions of 2.7.2.2, 2.7.2.4.1, 2.7.2.4.4, 2.7.2.4.5, 2.7.2.4.6 and 4.1.9.3; and, for a package containing fissile material and transported by air, the requirement of 6.4.11.10 shall be met. Changes in the design of the packaging or in the nature or quantity of the authorized radioactive contents which, as determined by the competent authority, would significantly affect safety shall require that the provisions of this Code be met in full. All packagings for which manufacture begins after 31 December 2006 shall meet the provisions of this Code in full.

**Special form radioactive material approved under the 1973, 1973 (as amended), 1985 and 1985 (as amended 1990) editions of IAEA Safety Series No. 6**

6.4.24.4 Special form radioactive material manufactured to a design which had received unilateral approval by the competent authority under the 1973, 1973 (as amended), 1985 or 1985 (as amended 1990) editions of IAEA Safety Series No. 6 may continue to be used when in compliance with the mandatory programme of quality assurance in accordance with the applicable provisions of 1.5.3.1. All special form radioactive material manufactured after 31 December 2003 shall meet the provisions of this Code in full.

## Chapter 6.5

### *Provisions for the construction and testing of intermediate bulk containers (IBCs)*

#### 6.5.1 General requirements

##### 6.5.1.1 Scope

6.5.1.1.1 The provisions of this chapter apply to IBCs intended for the transport of certain dangerous substances and materials.

6.5.1.1.2 IBCs and their service equipment not conforming strictly to the provisions herein, but conforming to acceptable alternatives, may be considered by the competent authority concerned for approval. In order to take into account progress in science and technology, the use of alternative arrangements which offer at least an equivalent degree of safety in transport in respect of compatibility with the substances to be loaded therein and an equivalent or superior resistance to handling impact, and fire, may be considered by the competent authority concerned.

6.5.1.1.3 The construction, equipment, testing, marking and operation of IBCs shall be subject to acceptance by the competent authority of the country in which the IBCs are approved.

6.5.1.1.4 Manufacturers and subsequent distributors of IBCs shall provide information regarding procedures to be followed and a description of the types and dimensions of closures (including required gaskets) and any other components needed to ensure that IBCs as presented for transport are capable of passing the applicable performance tests of this chapter.

##### 6.5.1.2 Definitions

*Body* (for all categories of IBCs other than composite IBCs) means the receptacle proper, including openings and their closures, but does not include service equipment;

*Handling device* (for flexible IBCs) means any sling, loop, eye or frame attached to the body of the IBC or formed from a continuation of the IBC body material;

*Maximum permissible gross mass* means the mass of the IBC and any service or structural equipment together with the maximum net mass;

*Plastics material*, when used in connection with inner receptacles for composite IBCs, is taken to include other polymeric materials such as rubber;

*Protected* (for metal IBCs) means the IBC being provided with additional protection against impact, the protection taking the form of, for example, a multi-layer (sandwich) or double-wall construction or a frame with a metal latticework packaging;

*Service equipment* means filling and discharge devices and, according to the category of IBC, pressure relief or venting, safety, heating and heat-insulating devices and measuring instruments;

*Structural equipment* (for all categories of IBCs other than flexible IBCs) means the reinforcing, fastening, handling, protective or stabilizing members of the body, including the base pallet for composite IBCs with plastics inner receptacle, fibreboard and wooden IBCs;

*Woven plastics* (for flexible IBCs) means a material made from stretched tapes or monofilaments of a suitable plastics material.

##### 6.5.1.3 Categories of IBCs

6.5.1.3.1 *Metal* IBCs consist of a metal body together with appropriate service and structural equipment.

6.5.1.3.2 *Flexible* IBCs consist of a body constituted of film, woven fabric or any other flexible material or combinations thereof, and if necessary an inner coating or liner, together with any appropriate service equipment and handling devices.

6.5.1.3.3 *Rigid plastics* IBCs consist of a rigid plastics body, which may have structural equipment together with appropriate service equipment.

Part 6 – Construction and testing of packagings, IBCs, etc.

6.5.1.3.4 Composite IBCs consist of structural equipment in the form of a rigid outer packaging enclosing a plastics inner receptacle together with any service or other structural equipment. The IBC is so constructed that the inner receptacle and outer packaging, once assembled, form, and are used as, an integrated single unit to be filled, stored, transported or emptied as such.

6.5.1.3.5 Fibreboard IBCs consist of a fibreboard body with or without separate top and bottom caps, if necessary, an inner liner (but no inner packagings) and appropriate service and structural equipment.

6.5.1.3.6 Wooden IBCs consist of a rigid or collapsible wooden body together with an inner liner (but no inner packagings) and appropriate service and structural equipment.

6.5.1.4 Designatory code system for IBCs

6.5.1.4.1 The code shall consist of two Arabic numerals as specified in .1 followed by one or more capital letters as specified in .2; followed, when specified in an individual section, by an Arabic numeral indicating the category of IBC.

.1

Type	For solids, filled or discharged		For liquids
	by gravity	under pressure of more than 10 kPa (0.1 bar)	
Rigid	11	21	31
Flexible	13	–	–

.2 Materials

- A Steel (all types and surface treatments)
- B Aluminium
- C Natural wood
- D Plywood
- F Reconstituted wood
- G Fibreboard
- H Plastics material
- L Textile
- M Paper, multiwall
- N Metal (other than steel or aluminium)

6.5.1.4.2 For a composite IBC, two capital letters in Latin characters shall be used in sequence in the second position of the code. The first shall indicate the material of the inner receptacle of the IBC and the second that of the outer packaging of the IBC.

6.5.1.4.3 The following types and codes of IBCs are assigned:

Material	Category	Code	Paragraph
<i>Metal</i>			
A Steel	for solids, filled or discharged by gravity for solids, filled or discharged under pressure for liquids	11A 21A 31A	6.5.5.1
B Aluminium	for solids, filled or discharged by gravity for solids, filled or discharged under pressure for liquids	11B 21B 31B	
N Other than steel or aluminium	for solids, filled or discharged by gravity for solids, filled or discharged under pressure for liquids	11N 21N 31N	
<i>Flexible</i>			
H Plastics	woven plastics without coating or liner woven plastics, coated woven plastics with liner woven plastics, coated and with liner plastics film	13H1 13H2 13H3 13H4 13H5	6.5.5.2
L Textile	without coating or liner coated with liner coated and with liner	13L1 13L2 13L3 13L4	

**Chapter 6.5 – Construction and testing of intermediate bulk containers (IBCs)**

Material	Category	Code	Paragraph
<i>Flexible</i> (continued) M Paper	multiwall multiwall, water-resistant	13M1 13M2	6.5.5.2
H Rigid plastics	for solids, filled or discharged by gravity, fitted with structural equipment for solids, filled or discharged by gravity, freestanding for solids, filled or discharged under pressure, fitted with structural equipment for solids, filled or discharged under pressure, freestanding for liquids, fitted with structural equipment for liquids, freestanding	11H1 11H2 21H1 21H2 31H1 31H2	6.5.5.3
HZ Composite with plastics inner receptacle*	for solids, filled or discharged by gravity, with rigid plastics inner receptacle for solids, filled or discharged by gravity, with flexible plastics inner receptacle for solids, filled or discharged under pressure, with rigid plastics inner receptacle for solids, filled or discharged under pressure, with flexible plastics inner receptacle for liquids, with rigid plastics inner receptacle for liquids, with flexible plastics inner receptacle	11HZ1 11HZ2 21HZ1 21HZ2 31HZ1 31HZ2	6.5.5.4
G Fibreboard	for solids, filled or discharged by gravity	11G	6.5.5.5
<i>Wooden</i> C Natural wood	for solids, filled or discharged by gravity, with inner liner	11C	6.5.5.6
D Plywood	for solids, filled or discharged by gravity, with inner liner	11D	
F Reconstituted wood	for solids, filled or discharged by gravity, with inner liner	11F	

\* The code shall be completed by replacing the letter 'Z' by a capital letter in accordance with 6.5.1.4.1.2 to indicate the nature of the material used for the outer packaging.

**6.5.1.4.4** The letter 'W' may follow the IBC code. The letter 'W' signifies that the IBC, although of the same type as indicated by the code, is manufactured to a specification different from those in section 6.5.3 and is considered equivalent in accordance with the provisions in 6.5.1.1.2.

## 6.5.2 Marking

### 6.5.2.1 Primary marking

**6.5.2.1.1** Each IBC manufactured and intended for use according to these provisions shall bear durable markings which are legible and placed in a location so as to be readily visible. Letters, numbers and symbols shall be at least 12 mm high and shall show:

- 1 the United Nations packaging symbol



This symbol shall not be used for any purpose other than certifying that a packaging, a flexible bulk container, a portable tank or a MEGC complies with the relevant requirements in Chapter 6.1, 6.2, 6.3, 6.5, 6.6, 6.7 or 6.9;

- 2 the code designating the type of IBC according to 6.5.1.4;
- 3 a capital letter designating the packing group(s) for which the design type has been approved:
  - “X” for packing groups I, II and III (IBCs for solids only);
  - “Y” for packing groups II and III; or
  - “Z” for packing group III only;
- 4 the month and year (last two digits) of manufacture;
- 5 the State authorizing the allocation of the mark, indicated by the distinguishing sign for motor vehicles in international traffic;
- 6 the name or symbol of the manufacturer and other identifications of the IBC as specified by the competent authority;

Part 6 – Construction and testing of packagings, IBCs, etc.

- .7 the stacking test load<sup>a</sup> in kilograms. For IBCs not designed for stacking, the figure “0” shall be shown;
- .8 the maximum permissible gross mass in kilograms.

The primary marking required above shall be applied in the sequence indicated in the subparagraphs .1 to .8 above. The additional marking required by 6.5.2.2 and any further marking authorized by a competent authority shall still enable the various parts of the mark to be correctly identified.

6.5.2.1.2 Examples of markings for various types of IBCs in accordance with .1 to .8 above:

- 

11A/Y/02 99/  
NL/...\* 007/  
5500/1500

For a metal IBC for solids discharged by gravity and made from steel/ for packing groups II and III/ manufactured in February 1999/ authorized by the Netherlands/ manufactured by . . . \*(name of manufacturer) and of a design type to which the competent authority has allocated serial number 007/ the stacking test load in kilograms/ and the maximum permissible gross mass in kilograms.
- 

13H3/Z/03 01/  
F/...\* 1713/  
0/1500

For a flexible IBC for solids discharged by gravity and made from woven plastics with a liner/ not designed to be stacked.
- 

31H1/Y/04 99/  
GB/...\* 9099/  
10800/1200

For a rigid plastics IBC for liquids made from plastics with structural equipment withstanding the stack load.
- 

31HA1/Y/05 01/  
D/...\* 1683/  
10800/1200

For a composite IBC for liquids with a rigid plastics inner receptacle and steel outer packaging.
- 

11C/X/01 02/  
S/...\* 9876/  
3000/910

For a wooden IBC for solids with an inner liner and authorized for packing group I solids.
- 

11G/Z/06 02/  
I/...\* 962/  
0/500

For a fibreboard IBC/ not designed to be stacked.
- 

11D/Y/07 02/  
E/...\* 261/  
3240/600

For a plywood IBC with inner liner.

Each element of the marking applied in accordance with subparagraphs .1 to .8 and with 6.5.2.2 shall be clearly separated, such as by a slash or space, so as to be easily identifiable.

6.5.2.2 Additional marking

6.5.2.2.1 Each IBC shall bear the markings required in 6.5.2.1 and, in addition, the following information, which may appear on a corrosion-resistant plate permanently attached in a place readily accessible for inspection:

Note: For metal IBCs, this plate shall be a corrosion-resistant metal plate.

Additional marking	Category of IBC				
	Metal	Rigid plastics	Composite	Fibreboard	Wooden
Capacity in litres <sup>a</sup> at 20°C	X	X	X		
Tare mass in kg <sup>a</sup>	X	X	X	X	X
Test (gauge) pressure, in kPa or bar, <sup>a</sup> if applicable		X	X		
Maximum filling/discharge pressure in kPa or bar, <sup>a</sup> if applicable	X	X	X		

<sup>a</sup> The stacking test load in kilograms to be placed on the IBC shall be 1.8 times the combined maximum permissible gross mass of the number of similar IBC that may be stacked on top of the IBC during transport (see 6.5.6.6.4).



**Chapter 6.5 – Construction and testing of intermediate bulk containers (IBCs)**

Additional marking	Category of IBC				
	Metal	Rigid plastics	Composite	Fibreboard	Wooden
Body material and its minimum thickness in mm	X				
Date of last leakproofness test, if applicable (month and year)	X	X	X		
Date of last inspection (month and year)	X	X	X		
Serial number of the manufacturer	X				
Maximum permitted stacking load <sup>b</sup>	X	X	X	X	X

<sup>a</sup> The unit used shall be indicated.

<sup>b</sup> See 6.5.2.2.2. This additional marking shall apply to all IBCs manufactured, repaired or remanufactured as from 1 January 2011.

**6.5.2.2.2** The maximum permitted stacking load applicable when the IBC is in use shall be displayed on a symbol as follows:

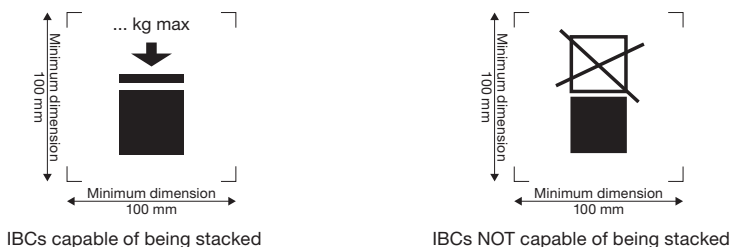

The symbol shall be not less than 100 mm × 100 mm, be durable and clearly visible. The letters and numbers indicating the mass shall be at least 12 mm high.

The mass marked above the symbol shall not exceed the load imposed during the design type test (see 6.5.6.6.4) divided by 1.8.

**Note:** The provisions of 6.5.2.2.2 shall apply to all IBCs manufactured, repaired or remanufactured as from 1 January 2011.

**6.5.2.2.3** Each flexible IBC may also bear a pictogram or pictograms indicating the recommended lifting methods.

**6.5.2.2.4** The inner receptacle of composite IBCs manufactured after 1 January 2011 shall bear the markings indicated in 6.5.2.1.1.2, .3, .4 where this date is that of the manufacture of the plastics inner receptacle, .5 and .6. The UN packaging symbol shall not be applied. The marking shall be applied in the sequence shown in 6.5.2.1.1. It shall be durable, legible and placed in a location so as to be readily visible when the inner receptacle is placed in the outer casing.

The date of the manufacture of the plastics inner receptacle may alternatively be marked on the inner receptacle adjacent to the remainder of the marking. An example of an appropriate marking method is:

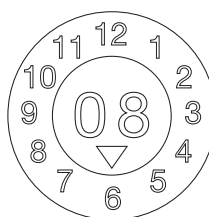

*Part 6 – Construction and testing of packagings, IBCs, etc.*

---

**6.5.2.2.5** Where a composite IBC is designed in such a manner that the outer packaging is intended to be dismantled for transport when empty (such as for return of the IBC for re-use to the original consignor), each of the parts intended to be detached when so dismantled shall be marked with the month and year of manufacture and the name or symbol of the manufacturer and other identification of the IBC as specified by the competent authority (see 6.5.2.1.1.6).

**6.5.2.3** **Conformity to design type**

The marking indicates that the IBCs correspond to a successfully tested design type and that the provisions referred to in the certificate have been met.

**6.5.2.4** **Marking of remanufactured composite IBCs (31HZ1)**

The marking specified in 6.5.2.1.1 and 6.5.2.2 shall be removed from the original IBC or made permanently illegible and new markings shall be applied to an IBC remanufactured in accordance with these provisions of this Code.

**6.5.3** **Construction requirements**

**6.5.3.1** **General requirements**

**6.5.3.1.1** IBCs shall be resistant to or adequately protected from deterioration due to the external environment.

**6.5.3.1.2** IBCs shall be so constructed and closed that none of the contents can escape under normal conditions of transport, including the effects of vibration, or by changes in temperature, humidity or pressure.

**6.5.3.1.3** IBCs and their closures shall be constructed of materials compatible with their contents, or be protected internally, so that they are not liable:

- .1 to be attacked by the contents so as to make their use dangerous;
- .2 to cause the contents to react or decompose, or form harmful or dangerous compounds with the IBCs.

**6.5.3.1.4** Gaskets, where used, shall be made of materials not subject to attack by the contents of an IBC.

**6.5.3.1.5** All service equipment shall be so positioned or protected as to minimize the risk of escape of the contents owing to damage during handling and transport.

**6.5.3.1.6** IBCs, their attachments and their service and structural equipment shall be designed to withstand, without loss of contents, the internal pressure of the contents and the stresses of normal handling and transport. IBCs intended for stacking shall be designed for stacking. Any lifting or securing features of IBCs shall be of sufficient strength to withstand the normal conditions of handling and transport without gross distortion or failure and shall be so positioned that no undue stress is caused in any part of the IBC.

**6.5.3.1.7** Where an IBC consists of a body within a framework, it shall be so constructed that:

- .1 the body does not chafe or rub against the framework so as to cause material damage to the body,
- .2 the body is retained within the framework at all times,
- .3 the items of equipment are fixed in such a way that they cannot be damaged if the connections between body and frame allow relative expansion or movement.

**6.5.3.1.8** Where a bottom discharge valve is fitted, it shall be capable of being made secure in the closed position and the whole discharge system shall be suitably protected from damage. Valves having lever closures shall be able to be secured against accidental opening and the open or closed position shall be readily apparent. For IBCs containing liquids, a secondary means of sealing the discharge aperture shall also be provided, such as by a blank flange or equivalent device.

**6.5.4** **Testing, certification and inspection**

**6.5.4.1** **Quality assurance**

IBC's shall be manufactured, remanufactured, repaired and tested under a quality-assurance programme which satisfies the competent authority, in order to ensure that each manufactured, remanufactured or repaired IBC meets the provisions of this chapter.

**Note:** ISO 16106:2006 "Packaging – Transport packages for dangerous goods – Dangerous goods packagings, intermediate bulk containers (IBCs) and large packagings – Guidelines for the application of ISO 9001" provides acceptable guidance on procedures which may be followed.

**6.5.4.2 Test provisions**

IBCs shall be subjected to design type tests and, if applicable, to initial and periodic inspections and tests in accordance with 6.5.4.4.

**6.5.4.3 Certification**

In respect of each design type of IBC, a certificate and mark (as in 6.5.2) shall be issued attesting that the design type, including its equipment, meets the test provisions.

**6.5.4.4 Inspection and testing**

**Note:** See also 6.5.4.5 for tests and inspections on repaired IBCs.

**6.5.4.4.1** Every metal, rigid plastics and composite IBC shall be inspected to the satisfaction of the competent authority:

- .1 before it is put into service (including after remanufactured), and thereafter at intervals not exceeding five years, with regard to:
  - .1 conformity to the design type, including marking;
  - .2 internal and external condition; and
  - .3 proper functioning of service equipment.

Thermal insulation, if any, need be removed only to the extent necessary for a proper examination of the body of the IBC.

- .2 at intervals of not more than two and a half years with regard to:

- .1 external condition; and
- .2 proper functioning of service equipment.

Thermal insulation, if any, need be removed only to the extent necessary for a proper examination of the body of the IBC.

Each IBC shall correspond in all respects to its design type.

**6.5.4.4.2** Every metal, rigid plastics and composite IBC for liquids, or for solids which are filled or discharged under pressure, shall undergo a suitable leakproofness test at least equally effective as the test prescribed in 6.5.6.7.3 and be capable of meeting the test level indicated in 6.5.6.7.3:

- (a) before it is first used for transport;
- (b) at intervals of not more than two and a half years.

For this test the IBC shall be fitted with the primary bottom closure. The inner receptacle of a composite IBC may be tested without the outer casing, provided the test results are not affected.

**6.5.4.4.3** A report of each inspection and test shall be kept by the owner of the IBC at least until the next inspection or test. The report shall include the results of the inspection and test and shall identify the party performing the inspection and test (see also the marking requirements in 6.5.2.2.1).

**6.5.4.4.4** The competent authority may at any time require proof, by tests in accordance with this chapter, that the IBCs meet the provisions of the design type tests.

**6.5.4.5 Repaired IBCs**

**6.5.4.5.1** When an IBC is impaired as a result of impact (e.g., accident) or any other cause, it shall be repaired or otherwise maintained (see definition of "Routine maintenance of IBCs" in 1.2.1), so as to conform to the design type. The bodies of rigid plastics IBCs and the inner receptacles of composite IBCs that are impaired shall be replaced.

**6.5.4.5.2** In addition to any other testing and inspection requirements in this Code, an IBC shall be subjected to the full testing and inspection requirements set out in 6.5.4.4, and the required reports shall be prepared, whenever it is repaired.

**6.5.4.5.3** The party performing the tests and inspections after the repair shall durably mark the IBC near the manufacturer's UN design type marking to show:

- .1 the State in which the tests and inspections were carried out;
- .2 the name or authorized symbol of the party performing the tests and inspections; and
- .3 the date (month, year) of the tests and inspections.

**6.5.4.5.4** Test and inspections performed in accordance with 6.5.4.5.2 may be considered to satisfy the requirements for the 2.5- and 5-year periodic tests and inspections.

6.5.5 Specific provisions for IBCs

6.5.5.1 Specific provisions for metal IBCs

6.5.5.1.1 These provisions apply to metal IBCs for the transport of liquids and solids. There are three categories of metal IBCs:

- those for solids which are filled and discharged by gravity (11A, 11B, 11N);
- those for solids which are filled and discharged at a gauge pressure greater than 10 kPa (21A, 21B, 21N);
- and
- those for liquids (31A, 31B, 31N).

6.5.5.1.2 Bodies shall be made of suitable ductile metal in which the weldability has been fully demonstrated. Welds shall be skilfully made and afford complete safety. Low-temperature performance shall be taken into account when appropriate.

6.5.5.1.3 Care shall be taken to avoid damage by galvanic action due to the juxtaposition of dissimilar metals.

6.5.5.1.4 Aluminium IBCs intended for the transport of flammable liquids shall have no movable parts, such as covers, closures, etc., made of unprotected steel liable to rust, which might cause a dangerous reaction by coming into frictional or percussive contact with the aluminium.

6.5.5.1.5 Metal IBCs shall be made of metals which meet the following provisions:

- .1 For steel, the elongation at fracture, per cent, shall not be less than  $10,000/R_m$  with an absolute minimum of 20%, where  $R_m$  = guaranteed minimum tensile strength of the reference steel to be used, in N/mm<sup>2</sup>.
- .2 For aluminium and aluminium alloys, the elongation at fracture, per cent, shall not be less than  $10,000/6R_m$  with an absolute minimum of 8%.

Specimens used to determine the elongation at fracture shall be taken transversely to the direction of rolling and be so secured that:

$$L_o = 5d, \text{ or}$$

$$L_o = 5.65\sqrt{A}$$

where :

- $L_o$  = gauge length of the specimen before the test;
- $d$  = diameter; and
- $A$  = cross-sectional area of the test specimen.

6.5.5.1.6 Minimum wall thickness

.1 For a reference steel having a product of  $R_m \times A_o = 10,000$ , the wall thickness shall not be less than:

Capacity (C) in litres	Wall thickness (T) in mm			
	Types 11A, 11B, 11N		Types 21A, 21B, 21N, 31A, 31B, 31N	
	Unprotected	Protected	Unprotected	Protected
$C \leq 1000$	2.0	1.5	2.5	2.0
$1000 < C \leq 2000$	$T = C/2000 + 1.5$	$T = C/2000 + 1.0$	$T = C/2000 + 2.0$	$T = C/2000 + 1.5$
$2000 < C \leq 3000$	$T = C/2000 + 1.5$	$T = C/2000 + 1.0$	$T = C/1000 + 1.0$	$T = C/2000 + 1.5$

where:  $A_o$  = minimum elongation (as a percentage) of the reference steel to be used on fracture under tensile stress (see 6.5.5.1.5).

.2 For metals other than the reference steel described in .1, the minimum wall thickness is given by the following equivalence formula:

$$e_1 = \frac{21.4 \times e_0}{\sqrt[3]{R_{m1} \times A_1}}$$

where:

- $e_1$  = required equivalent wall thickness of the metal to be used (in mm);
- $e_0$  = required minimum wall thickness for the reference steel (in mm);
- $R_{m1}$  = guaranteed minimum tensile strength of the metal to be used (in N/mm<sup>2</sup>) (see .3); and
- $A_1$  = minimum elongation (as a percentage) of the metal to be used on fracture under tensile stress (see 6.5.5.1.5).

However, in no case shall the wall thickness be less than 1.5 mm.

.3 For purposes of the calculation described in .2, the guaranteed minimum tensile strength of the metal to be used ( $R_{m1}$ ) shall be the minimum value according to national or international material standards.

However, for austenitic steels, the specified minimum value for  $R_m$  according to the material standards may be increased by up to 15% when a greater value is attested in the material inspection certificate. When no material standard exists for the material in question, the value of  $R_m$  shall be the minimum value attested in the material inspection certificate.

**6.5.5.1.7 Pressure relief provisions**

IBCs for liquids shall be capable of releasing a sufficient amount of vapour in the event of fire engulfment to ensure that no rupture of the shell will occur. This can be achieved by conventional pressure relief devices or by other constructional means. The start-to-discharge pressure shall not be higher than 65 kPa and no lower than the total gauge pressure experienced in the IBC (i.e., the vapour pressure of the filling substance plus the partial pressure of the air or other inert gases, minus 100 kPa) at 55°C, determined on the basis of a maximum degree of filling as defined in 4.1.1.4. The pressure relief devices shall be fitted in the vapour space.

**6.5.5.2 Specific provisions for flexible IBCs**

**6.5.5.2.1** These provisions apply to flexible IBCs of the following types:

- 13H1 woven plastics without coating or liner
- 13H2 woven plastics, coated
- 13H3 woven plastics with liner
- 13H4 woven plastics, coated and with liner
- 13H5 plastics film
- 13L1 textile without coating or liner
- 13L2 textile, coated
- 13L3 textile with liner
- 13L4 textile, coated and with liner
- 13M1 paper, multiwall
- 13M2 paper, multiwall, water-resistant.

Flexible IBCs are intended for the transport of solids only.

**6.5.5.2.2** Bodies of IBCs shall be manufactured from suitable materials. The strength of the material and the construction of a flexible IBC shall be appropriate to its capacity and its intended use.

**6.5.5.2.3** All materials used in the construction of flexible IBCs of types 13M1 and 13M2 shall, after complete immersion in water for not less than 24 hours, retain at least 85% of the tensile strength as measured originally on the material conditioned to equilibrium at 67% relative humidity or less.

**6.5.5.2.4** Seams of IBCs shall be formed by stitching, heat sealing, gluing or any equivalent method. All stitched seams shall be secured.

**6.5.5.2.5** Flexible IBCs shall provide adequate resistance to ageing and to degradation caused by ultraviolet radiation, by climatic conditions, or by the substance contained within which would thereby render them unsuitable for their intended use.

**6.5.5.2.6** For plastics flexible IBCs where protection against ultraviolet radiation is required, it shall be provided by the addition of carbon black or other suitable pigments or inhibitors. These additives shall be compatible with the contents and remain effective throughout the life of the body of the IBC. Where use is made of carbon black, pigments or inhibitors other than those used in the manufacture of the tested design type, retesting may be waived if changes in the carbon black content, the pigment content or the inhibitor content do not adversely affect the physical properties of the material of construction.

**6.5.5.2.7** Additives may be incorporated into the material of the body to improve the resistance to ageing or to serve other purposes, provided that these do not adversely affect the physical or chemical properties of the material.

**6.5.5.2.8** No material recovered from used receptacles shall be used in the manufacture of IBC bodies. Production residues or scrap from the same manufacturing process may, however, be used. Component parts such as fittings and pallet bases may also be used provided such components have not in any way been damaged in previous use.

**6.5.5.2.9** When filled, the ratio of height to width shall be not more than 2:1.

**6.5.5.2.10** The liner shall be made of a suitable material. The strength of the material used and the construction of the liner shall be appropriate to the capacity of the IBC and the intended use. Joints and closures shall be sift-proof and capable of withstanding pressures and impacts liable to occur under normal conditions of handling and transport.

## Part 6 – Construction and testing of packagings, IBCs, etc.

## 6.5.5.3 Specific provisions for rigid plastics IBCs

6.5.5.3.1 These provisions apply to rigid plastics IBCs for the transport of solids or liquids. Rigid plastics IBCs are of the following types:

- 11H1 fitted with structural equipment designed to withstand the whole load when IBCs are stacked, for solids which are filled or discharged by gravity
- 11H2 freestanding, for solids which are filled or discharged by gravity
- 21H1 fitted with structural equipment designed to withstand the whole load when IBCs are stacked, for solids which are filled or discharged under pressure
- 21H2 freestanding, for solids which are filled or discharged under pressure
- 31H1 fitted with structural equipment designed to withstand the whole load when IBCs are stacked, for liquids
- 31H2 freestanding, for liquids.

6.5.5.3.2 The body shall be manufactured from suitable plastics material of known specifications and be of adequate strength in relation to its capacity and to the service it is required to perform. The material shall be adequately resistant to ageing and to degradation caused by the substance contained within or, where relevant, by ultraviolet radiation. Low-temperature performance shall be taken into account when appropriate. Any permeation of the substance contained within shall not constitute a danger under normal conditions of transport.

6.5.5.3.3 Where protection against ultraviolet radiation is required, it shall be provided by the addition of carbon black or other suitable pigments or inhibitors. These additives shall be compatible with the contents and remain effective throughout the life of the body of the IBC. Where use is made of carbon black, pigments or inhibitors other than those used in the manufacture of the tested design type, retesting may be waived if changes in the carbon black content, the pigment content or the inhibitor content do not adversely affect the physical properties of the material of construction.

6.5.5.3.4 Additives may be incorporated in the material of the body to improve the resistance to ageing or to serve other purposes, provided that these do not adversely affect the physical or chemical properties of the material.

6.5.5.3.5 No used material other than production residues or regrind from the same manufacturing process may be used in the manufacturing of rigid plastics IBCs.

## 6.5.5.4 Specific provisions for composite IBCs with plastics inner receptacles

6.5.5.4.1 These provisions apply to composite IBCs for the transport of solids or liquids of the following types:

- 11HZ1 composite IBCs with a rigid plastics inner receptacle, for solids filled or discharged by gravity
- 11HZ2 composite IBCs with a flexible plastics inner receptacle, for solids filled or discharged by gravity
- 21HZ1 composite IBCs with a rigid plastics inner receptacle, for solids filled or discharged under pressure
- 21HZ2 composite IBCs with a flexible plastics inner receptacle, for solids filled or discharged under pressure
- 31HZ1 composite IBCs with a rigid plastics inner receptacle, for liquids
- 31HZ2 composite IBCs with a flexible plastics inner receptacle, for liquids.

This code shall be completed by replacing the letter 'Z' by a capital letter in accordance with 6.5.1.4.1.2 to indicate the nature of the material used for the outer packaging.

6.5.5.4.2 The inner receptacle is not intended to perform a containment function without its outer packaging. A "rigid" inner receptacle is a receptacle which retains its general shape when empty without closures in place and without the benefit of the outer packaging. Any inner receptacle that is not "rigid" is considered to be "flexible".

6.5.5.4.3 The outer packaging normally consists of rigid material formed so as to protect the inner receptacle from physical damage during handling and transport, but is not intended to perform the containment function. It includes the base pallet where appropriate.

6.5.5.4.4 A composite IBC with a fully enclosing outer packaging shall be so designed that the integrity of the inner receptacle may be readily assessed following the leakproofness and hydraulic tests.

6.5.5.4.5 IBCs of type 31HZ2 shall be limited to a capacity of not more than 1250 ℓ.

6.5.5.4.6 The inner receptacle shall be manufactured from suitable plastics material of known specifications and be of adequate strength in relation to its capacity and to the service it is required to perform. The material shall be adequately resistant to ageing and to degradation caused by the substance contained and, where relevant, by ultraviolet radiation. Low-temperature performance shall be taken into account when appropriate. Any permeation of the substance contained shall not constitute a danger under normal conditions of transport.

**Chapter 6.5 – Construction and testing of intermediate bulk containers (IBCs)**

- 6.5.5.4.7 Where protection against ultraviolet radiation is required, it shall be provided by the addition of carbon black or other suitable pigments or inhibitors. These additives shall be compatible with the contents and remain effective throughout the life of the inner receptacle. Where use is made of carbon black, pigments or inhibitors other than those used in the manufacture of the tested design type, re-testing may be waived if changes in carbon black content, the pigment content or the inhibitor content do not adversely affect the physical properties of the material of construction.
- 6.5.5.4.8 Additives may be incorporated in the material of the inner receptacle to improve the resistance to ageing or to serve other purposes, provided that these do not adversely affect the physical or chemical properties of the material.
- 6.5.5.4.9 No used material other than production residues or regrind from the same manufacturing process may be used in the manufacture of inner receptacles.
- 6.5.5.4.10 The inner receptacle of IBCs of type 31HZ2 shall consist of at least three plies of film.
- 6.5.5.4.11 The strength of the material and the construction of the outer packaging shall be appropriate to the capacity of the composite IBC and its intended use.
- 6.5.5.4.12 The outer packaging shall be free of any projection that might damage the inner receptacle.
- 6.5.5.4.13 Outer packagings of steel or aluminium shall be constructed of a suitable metal of adequate thickness.
- 6.5.5.4.14 Outer packagings of natural wood shall be of well-seasoned wood, commercially dry and free from defects that would materially lessen the strength of any part of the packaging. The tops and bottoms may be made of water-resistant reconstituted wood such as hardboard, particle board or other suitable type.
- 6.5.5.4.15 Outer packagings of plywood shall be made of well-seasoned rotary-cut, sliced or sawn veneer plywood, commercially dry and free from defects that would materially lessen the strength of the packaging. All adjacent plies shall be glued with water-resistant adhesive. Other suitable materials may be used in conjunction with plywood for the construction of packagings. Packagings shall be firmly nailed or secured to corner posts or ends or be assembled by equally suitable devices.
- 6.5.5.4.16 The walls of outer packagings of reconstituted wood shall be made of water-resistant reconstituted wood such as hardboard, particle board or other suitable type. Other parts of the packagings may be made of other suitable material.
- 6.5.5.4.17 For fibreboard outer packagings, strong and good-quality solid or double-faced corrugated fibreboard (single or multiwall) shall be used appropriate to the capacity of the packaging and to its intended use. The water resistance of the outer surface shall be such that the increase in mass, as determined in a test carried out over 30 minutes by the Cobb method of determining water absorption, is not greater than 155 g/m<sup>2</sup> – see ISO 535:1991. It shall have proper bending qualities. Fibreboard shall be cut, creased without scoring, and slotted so as to permit assembly without cracking, surface breaks or undue bending. The fluting of corrugated fibreboard shall be firmly glued by water-resistant adhesive to the facings.
- 6.5.5.4.18 The ends of fibreboard outer packagings may have a wooden frame or be entirely of wood. Reinforcements of wooden battens may be used.
- 6.5.5.4.19 Manufacturing joints in the fibreboard outer packagings shall be taped, lapped and glued, or lapped and stitched with metal staples. Lapped joints shall have an appropriate overlap. Where closing is effected by gluing or taping, a water-resistant adhesive shall be used.
- 6.5.5.4.20 Where the outer packagings are of plastics material, the relevant provisions of 6.5.5.4.6 to 6.5.5.4.9 shall apply.
- 6.5.5.4.21 The outer packagings of IBCs of type 31HZ2 shall enclose the inner receptacle on all sides.
- 6.5.5.4.22 Any integral pallet base forming part of the IBC or a detachable pallet shall be suitable for mechanical handling with the IBC filled to its maximum permissible gross mass.
- 6.5.5.4.23 The pallet or integral base shall be designed so as to avoid any protrusion of the base of the IBC that might be liable to damage in handling.
- 6.5.5.4.24 The outer packagings shall be secured to a detachable pallet to ensure stability in handling and transport. Where a detachable pallet is used, its top surface shall be free from sharp protrusions that might damage the IBC.
- 6.5.5.4.25 Strengthening devices such as timber supports to increase stacking performance may be used but shall be external to the inner receptacle.
- 6.5.5.4.26 Where IBCs are intended for stacking, the bearing surfaces shall be such as to distribute the load in a safe manner. Such IBCs shall be designed so that the load is not supported by the inner receptacle.

## Part 6 – Construction and testing of packagings, IBCs, etc.

**6.5.5.5 Specific provisions for fibreboard IBCs**

- 6.5.5.5.1** These provisions apply to fibreboard IBCs for the transport of solids which are filled or discharged by gravity. Fibreboard IBCs are of the following type: 11G.
- 6.5.5.5.2** Fibreboard IBCs shall not incorporate top lifting devices.
- 6.5.5.5.3** The body shall be made of strong and good-quality solid or double-faced corrugated fibreboard (single or multiwall), appropriate to the capacity of the IBC and to its intended use. The water resistance of the outer surface shall be such that the increase in mass, as determined in a test carried out over a period of 30 minutes by the Cobb method of determining water absorption, is not greater than 155 g/m<sup>2</sup> – see ISO 535:1991. It shall have proper bending qualities. Fibreboard shall be cut, creased without scoring, and slotted so as to permit assembly without cracking, surface breaks or undue bending. The fluting or corrugated fibreboard shall be firmly glued to the facings.
- 6.5.5.5.4** The walls, including top and bottom, shall have a minimum puncture resistance of 15 J, measured according to ISO 3036:1975.
- 6.5.5.5.5** Manufacturing joins in the body of IBCs shall be made with an appropriate overlap and shall be taped, glued, stitched with metal staples or fastened by other means at least equally effective. Where joins are effected by gluing or taping, a water-resistant adhesive shall be used. Metal staples shall pass completely through all pieces to be fastened and be formed or protected so that any inner liner cannot be abraded or punctured by them.
- 6.5.5.5.6** The liner shall be made of suitable material. The strength of the material used and the construction of the liner shall be appropriate to the capacity of the IBC and its intended use. Joins and closures shall be sift-proof and capable of withstanding pressure and impacts liable to occur under normal conditions of handling and transport.
- 6.5.5.5.7** Any integral pallet base forming part of the IBC or any detachable pallet shall be suitable for mechanical handling with the IBC filled to its maximum permissible gross mass.
- 6.5.5.5.8** The pallet or integral base shall be designed so as to avoid any protrusion of the base of the IBC that might be liable to damage in handling.
- 6.5.5.5.9** The body shall be secured to any detachable pallet to ensure stability in handling and transport. Where a detachable pallet is used, its top surface shall be free from sharp protrusions that might damage the IBC.
- 6.5.5.5.10** Strengthening devices such as timber supports to increase stacking performance may be used but shall be external to the liner.
- 6.5.5.5.11** Where IBCs are intended for stacking, the bearing surface shall be such as to distribute the load in a safe manner.

**6.5.5.6 Specific provisions for wooden IBCs**

- 6.5.5.6.1** These provisions apply to wooden IBCs for the transport of solids which are filled or discharged by gravity. Wooden IBCs are of the following types:
- 11C natural wood with inner liner
  - 11D plywood with inner liner
  - 11F reconstituted wood with inner liner.
- 6.5.5.6.2** Wooden IBCs shall not incorporate top lifting devices.
- 6.5.5.6.3** The strength of the materials used and the method of construction shall be appropriate to the capacity and intended use of the IBC.
- 6.5.5.6.4** Natural wood shall be well seasoned, commercially dry and free from defects that would materially lessen the strength of any part of the IBC. Each part of the IBC shall consist of one piece or be equivalent thereto. Parts are considered equivalent to one piece when a suitable method of glued assembly is used (as for instance Lindermann joint, tongue and groove joint, ship lap or rabbet joint, or butt joint), with at least two corrugated metal fasteners at each joint, or when other methods at least equally effective are used.
- 6.5.5.6.5** Bodies of plywood shall be at least three-ply. It shall be made of well-seasoned rotary-cut, sliced or sawn veneer, commercially dry and free from defects that would materially lessen the strength of the body. All adjacent plies shall be glued with water-resistant adhesive. Other suitable materials may be used with plywood for the construction of the body.
- 6.5.5.6.6** Bodies of reconstituted wood shall be made of water-resistant reconstituted wood such as hardboard, particle board or other suitable type.
- 6.5.5.6.7** IBCs shall be firmly nailed or secured to corner posts or ends or be assembled by equally suitable devices.



- 6.5.5.6.8 The liner shall be made of a suitable material. The strength of the material used and the construction of the liner shall be appropriate to the capacity of the IBC and its intended use. Joins and closures shall be sift-proof and capable of withstanding pressure and impacts liable to occur under normal conditions of handling and transport.
- 6.5.5.6.9 Any integral pallet base forming part of the IBC or any detachable pallet shall be suitable for mechanical handling with the IBC filled to its maximum permissible gross mass.
- 6.5.5.6.10 The pallet or integral base shall be designed so as to avoid any protrusion of the base of the IBC that might be liable to damage in handling.
- 6.5.5.6.11 The body shall be secured to any detachable pallet to ensure stability in handling and transport. Where a detachable pallet is used, its top surface shall be free from sharp protrusions that might damage the IBC.
- 6.5.5.6.12 Strengthening devices such as timber supports to increase stacking performance may be used but shall be external to the liner.
- 6.5.5.6.13 Where IBCs are intended for stacking, the bearing surface shall be such as to distribute the load in a safe manner.

## 6.5.6 Test provisions for IBCs

### 6.5.6.1 Performance and frequency of tests

- 6.5.6.1.1 Each IBC design type shall successfully pass the tests prescribed in this chapter before being used. An IBC design type is defined by the design, size and material and thickness, manner of construction and means of filling and discharging, but may include various surface treatments; it also includes IBCs which differ from the design type only in their lesser external dimensions.
- 6.5.6.1.2 Tests shall be carried out on IBCs as prepared for transport. IBCs shall be filled as indicated in the relevant section. The substances to be transported in the IBCs may be replaced by other substances except where this would invalidate the results of the tests. For solids, when another substance is used, it shall have the same physical characteristics (mass, grain size, etc.) as the substance to be transported. It is permissible to use additives, such as bags of lead shot, to achieve the requisite total package gross mass, so long as they are placed so that the test results are not affected.

### 6.5.6.2 Design type tests

- 6.5.6.2.1 One IBC of each design type, size, wall thickness and manner of construction shall be submitted to the tests in the order shown in 6.5.6.3.5 and as set out in 6.5.6.4 to 6.5.6.13. These design type tests shall be carried out as required by the competent authority.
- 6.5.6.2.2 The competent authority may permit the selective testing of IBCs which differ only in minor respects from the tested type, such as with small reductions in external dimensions.
- 6.5.6.2.3 If detachable pallets are used in the tests, the test report issued in accordance with 6.5.6.14 shall include a technical description of the pallets to be used.

### 6.5.6.3 Preparation of IBC for testing

- 6.5.6.3.1 Paper and fibreboard IBCs and composite IBCs with fibreboard outer packagings shall be conditioned for at least 24 hours in an atmosphere having a controlled temperature and relative humidity (r.h.). There are three options, one of which shall be chosen. The preferred atmosphere is 23°C±2°C and 50%±2% r.h. The two other options are 20°C±2°C and 65%±2% r.h. or 27°C±2°C and 65%±2% r.h.

**Note:** Average values shall fall within these limits. Short-term fluctuations and measurement limitations may cause individual measurements to vary by up to ±5% relative humidity without significant impairment of test reproducibility.

- 6.5.6.3.2 Additional steps shall be taken to ascertain that the plastics material used in the manufacture of rigid plastics IBCs of types 31H1 and 31H2 and composite IBCs of type 31HZ1 and 31HZ2 complies with the provisions of 6.5.5.3.2 to 6.5.5.3.4 and 6.5.5.4.6 to 6.5.5.4.9.
- 6.5.6.3.3 This may be done, for example, by submitting sample IBCs to a preliminary test extending over a long period, for example six months, during which the samples would remain filled with the substances they are intended to contain or with substances which are known to have at least as severe a stress-cracking, weakening or molecular degradation influence on the plastics materials in question, and after which the samples shall be submitted to the applicable tests listed in the table in 6.5.6.3.5.

**Part 6 – Construction and testing of packagings, IBCs, etc.**

**6.5.6.3.4** Where the behaviour of the plastics material has been established by other means, the above compatibility test may be dispensed with.

**6.5.6.3.5** Design type tests required in sequential order:

Type of IBC	Vibration <sup>f</sup>	Bottom lift	Top lift <sup>a</sup>	Stacking <sup>b</sup>	Leak-proofness	Hydraulic pressure	Drop	Tear	Topple	Righting <sup>c</sup>
<b>Metal:</b>										
11A, 11B, 11N	–	1st <sup>a</sup>	2nd	3rd	–	–	4th <sup>e</sup>	–	–	–
21A, 21B, 21N	–	1st <sup>a</sup>	2nd	3rd	4th	5th	6th <sup>e</sup>	–	–	–
31A, 31B, 31N	1st	2nd <sup>a</sup>	3rd	4th	5th	6th	7th <sup>e</sup>	–	–	–
<b>Flexible<sup>d</sup></b>	–	–	x <sup>c</sup>	x	–	–	x	x	x	x
<b>Rigid plastics:</b>										
11H1, 11H2	–	1st <sup>a</sup>	2nd	3rd	–	–	4th	–	–	–
21H1, 21H2	–	1st <sup>a</sup>	2nd	3rd	4th	5th	6th	–	–	–
31H1, 31H2	1st	2nd <sup>a</sup>	3rd	4th	5th	6th	7th	–	–	–
<b>Composite:</b>										
11HZ1, 11HZ2	–	1st <sup>a</sup>	2nd	3rd	–	–	4th <sup>e</sup>	–	–	–
21HZ1, 21HZ2	–	1st <sup>a</sup>	2nd	3rd	4th	5th	6th <sup>e</sup>	–	–	–
31HZ1, 31HZ2	1st	2nd <sup>a</sup>	3rd	4th	5th	6th	7th <sup>e</sup>	–	–	–
<b>Fibreboard</b>	–	1st	–	2nd	–	–	3rd	–	–	–
<b>Wooden</b>	–	1st	–	2nd	–	–	3rd	–	–	–

<sup>a</sup> When IBCs are designed for this method of handling.

<sup>b</sup> When IBCs are designed to be stacked.

<sup>c</sup> When IBCs are designed to be lifted from the top or the side.

<sup>d</sup> Required test indicated by "x"; an IBC which has passed one test may be used for other tests, in any order.

<sup>e</sup> Another IBC of the same design may be used for the drop test.

<sup>f</sup> Another IBC of the same design may be used for the vibration test.

**6.5.6.4 Bottom lift test**

**6.5.6.4.1 Applicability**

For all fibreboard and wooden IBCs and for all types of IBCs which are fitted with means for lifting from the base, as a design type test.

**6.5.6.4.2 Preparation of the IBC for test**

The IBC shall be filled. A load shall be added and evenly distributed. The mass of filled IBC and the load shall be 1.25 times its maximum permissible gross mass.

**6.5.6.4.3 Method of testing**

The IBC shall be raised and lowered twice by a forklift truck with the forks centrally positioned so that the space between them is three quarters of the length of the side of entry (unless the points of entry are fixed). The forks shall penetrate to three quarters of the depth in the direction of entry. The test shall be repeated from each possible direction of entry.

**6.5.6.4.4 Criteria for passing the test**

No permanent deformation which renders the IBC, including the base pallet, if any, unsafe for transport and no loss of contents.

**6.5.6.5 Top lift test**

**6.5.6.5.1 Applicability**

For all types of IBCs which are designed to be lifted from the top, and for flexible IBCs designed to be lifted from the top or the side, as a design type test.

**6.5.6.5.2 Preparation of the IBC for test**

Metal, rigid plastics and composite IBCs shall be filled. A load shall be added and evenly distributed. The mass of filled IBC and the load shall be twice the maximum permissible gross mass. Flexible IBCs shall be filled with a representative material and then shall be loaded to six times their maximum permissible gross mass, the load being evenly distributed.

**6.5.6.5.3 Method of testing**

Metal and flexible IBCs shall be lifted in the manner for which they are designed until clear of the floor and maintained in that position for a period of five minutes.

Rigid plastics and composite IBCs shall be lifted:

- .1 by each pair of diagonally opposite lifting devices, so that the hoisting forces are applied vertically, for a period of five minutes; and
- .2 by each pair of diagonally opposite lifting devices, so that the hoisting forces are applied towards the centre at 45° to the vertical, for a period of five minutes.

**6.5.6.5.4** Other methods of top-lift testing and preparation at least equally effective may be used for flexible IBCs.

**6.5.6.5.5 Criteria for passing the test**

- .1 Metal, rigid plastics and composite IBCs: the IBC remains safe for normal conditions of transport, there is no observable permanent deformation of the IBC, including the base pallet, if any, and no loss of contents.
- .2 Flexible IBCs: no damage to the IBC or its lifting devices which renders the IBC unsafe for transport or handling and no loss of contents.

**6.5.6.6 Stacking test**

**6.5.6.6.1 Applicability**

For all types of IBCs which are designed to be stacked on each other, as a design type test.

**6.5.6.6.2 Preparation of the IBC for test**

The IBC shall be filled to its maximum permissible gross mass. If the specific gravity of the product being used for testing makes this impracticable, the IBC shall additionally be loaded so that it is tested at its maximum permissible gross mass, the load being evenly distributed.

**6.5.6.6.3 Method of testing**

- .1 The IBC shall be placed on its base on level hard ground and subjected to a uniformly distributed superimposed test load (see 6.5.6.6.4). IBCs shall be subjected to the test load for a period of at least:
  - 5 minutes, for metal IBCs;
  - 28 days at 40°C, for rigid plastics IBCs of types 11H2, 21H2 and 31H2 and for composite IBCs with outer packagings of plastics material which bear the stacking load (i.e., types 11HH1, 11HH2, 21HH1, 21HH2, 31HH1 and 31HH2);
  - 24 hours, for all other types of IBCs.
- .2 The load shall be applied by one of the following methods:
  - one or more IBCs of the same type, filled to the maximum permissible gross mass, stacked on the test IBC;
  - appropriate mass loaded on to either a flat plate or a reproduction of the base of the IBC, which is stacked on the test IBC.

**6.5.6.6.4 Calculation of superimposed test load**

The load to be placed on the IBC shall be 1.8 times the combined maximum permissible gross mass of the number of similar IBCs that may be stacked on top of the IBC during transport.

**6.5.6.6.5 Criteria for passing the test**

- .1 All types of IBCs other than flexible IBCs: no permanent deformation which renders the IBC, including the base pallet, if any, unsafe for transport and no loss of contents.
- .2 Flexible IBCs: no deterioration of the body which renders the IBC unsafe for transport and no loss of contents.

**6.5.6.7 Leakproofness test**

**6.5.6.7.1 Applicability**

For those types of IBCs used for liquids, or for solids filled or discharged under pressure, as a design type test and a periodic test.

## Part 6 – Construction and testing of packagings, IBCs, etc.

**6.5.6.7.2 Preparation of the IBC for test**

The test shall be carried out before the fitting of any thermal insulation equipment. Vented closures shall either be replaced by similar non-vented closures or the vent shall be sealed.

**6.5.6.7.3 Method of testing and pressure to be applied**

The test shall be carried out for a period of at least 10 minutes, using air at a gauge pressure of not less than 20 kPa (0.2 bar). The airtightness of the IBC shall be determined by a suitable method such as air-pressure differential test or by immersing the IBC in water, or for metal IBCs, by coating the seams and joints with a soap solution. In the latter case, a correction factor shall be applied for the hydrostatic pressure.

**6.5.6.7.4 Criterion for passing the test**

No leakage of air.

**6.5.6.8 Hydraulic pressure test****6.5.6.8.1 Applicability**

For those types of IBCs used for liquids or for solids filled or discharged under pressure, as a design type test.

**6.5.6.8.2 Preparation of the IBC for test**

The test shall be carried out before the fitting of any thermal insulation equipment. Pressure relief devices shall be removed and their apertures plugged, or shall be rendered inoperative.

**6.5.6.8.3 Method of testing**

The test shall be carried out for a period of at least ten minutes, applying a hydraulic pressure of not less than that indicated in 6.5.6.8.4. The IBC shall not be mechanically restrained during the test.

**6.5.6.8.4 Pressures to be applied****6.5.6.8.4.1 Metal IBCs:**

- .1 For IBCs of types 21A, 21B and 21N, for packing group I solids, a 250 kPa (2.5 bar) gauge pressure;
- .2 For IBCs of types 21A, 21B, 21N, 31A, 31B and 31N, for packing groups II or III substances, a 200 kPa (2 bar) gauge pressure;
- .3 In addition, for IBCs of types 31A, 31B and 31N, a 65 kPa (0.65 bar) gauge pressure. This test shall be performed before the 200 kPa (2 bar) test.

**6.5.6.8.4.2 Rigid plastics and composite IBCs:**

- .1 For IBCs of types 21H1, 21H2, 21HZ1 and 21HZ2: 75 kPa (0.75 bar) gauge;
- .2 For IBCs of types 31H1, 31H2, 31HZ1 and 31HZ2: whichever is the greater of two values, the first as determined by one of the following methods:
  - the total gauge pressure measured in the IBC (i.e., the vapour pressure of the filling substance and the partial pressure of the air or other inert gases, minus 100 kPa) at 55°C multiplied by a safety factor of 1.5; this total gauge pressure shall be determined on the basis of a maximum degree of filling in accordance with 4.1.1.4 and a filling temperature of 15°C; or
  - 1.75 times the vapour pressure at 50°C of the substance to be transported minus 100 kPa, but with a minimum test pressure of 100 kPa; or
  - 1.5 times the vapour pressure at 55°C of the substance to be transported minus 100 kPa, but with a minimum test pressure of 100 kPa;
 and the second as determined by the following method:
  - twice the static pressure of the substance to be transported, with a minimum of twice the static pressure of water.

**6.5.6.8.5 Criteria for passing the test(s)**

- .1 For IBCs of types 21A, 21B, 21N, 31A, 31B and 31N, when subjected to the test pressure specified in 6.5.6.8.4.1.1 or .2: no leakage;
- .2 For IBCs of types 31A, 31B and 31N, when subjected to the test pressure specified in 6.5.6.8.4.1.3: neither permanent deformation which would render the IBC unsafe for transport nor leakage; and
- .3 For rigid plastics and composite IBCs: no permanent deformation which would render the IBC unsafe for transport and no leakage.

**6.5.6.9 Drop test**

**6.5.6.9.1 Applicability**

For all types of IBCs, as a design type test.

**6.5.6.9.2 Preparation of the IBC for test**

- .1 Metal IBCs: the IBC shall be filled to not less than 95% of its maximum capacity for solids or 98% of its maximum capacity for liquids. Pressure relief devices shall be rendered inoperative or shall be removed and their apertures sealed.
- .2 Flexible IBCs: the IBC shall be filled to the maximum permissible gross mass, the contents being evenly distributed.
- .3 Rigid plastics and composite IBCs: the IBC shall be filled to not less than 95% of its maximum capacity for solids or 98% of its maximum capacity for liquids. Arrangements provided for pressure relief may be removed and sealed or rendered inoperative. Testing of IBCs shall be carried out when the temperature of the test sample and its contents has been reduced to  $-18^{\circ}\text{C}$  or lower. Where test samples of composite IBCs are prepared in this way, the conditioning specified in 6.5.6.3.1 may be waived. Test liquids shall be kept in the liquid state, if necessary by the addition of anti-freeze. This conditioning may be disregarded if the materials in question are of sufficient ductility and tensile strength at low temperatures.
- .4 Fibreboard and wooden IBCs: the IBC shall be filled to not less than 95% of its maximum capacity.

**6.5.6.9.3 Method of testing**

The IBC shall be dropped on its base onto a non-resilient, horizontal, flat, massive and rigid surface in conformity with the requirements of 6.1.5.3.4, in such a manner as to ensure that the point of impact is that part of the base of the IBC considered to be the most vulnerable. IBCs of  $0.45\text{ m}^3$  or less capacity shall also be dropped:

- .1 Metal IBCs: on the most vulnerable part other than the part of the base of the IBC tested in the first drop;
- .2 Flexible IBCs: on the most vulnerable side;
- .3 Rigid plastics, composite, fibreboard and wooden IBCs: flat on a side, flat on the top and on a corner.

The same or different IBCs may be used for each drop.

**6.5.6.9.4 Drop height**

For solids and liquids, if the test is performed with the solid or liquid to be transported or with another substance having essentially the same physical characteristics:

Packing group I	Packing group II	Packing group III
1.8 m	1.2 m	0.8 m

For liquids, if the test is performed with water:

- (a) where the substances to be transported have a relative density not exceeding 1.2:

Packing group II	Packing group III
1.2 m	0.8 m

- (b) where the substances to be transported have a relative density exceeding 1.2, the drop heights shall be calculated on the basis of the relative density ( $d$ ) of the substance to be transported rounded up to the first decimal as follows:

Packing group II	Packing group III
$d \times 1.0\text{ m}$	$d \times 0.67\text{ m}$

**6.5.6.9.5 Criterion for passing the test(s)**

- .1 Metal IBCs: no loss of contents.
- .2 Flexible IBCs: no loss of contents. A slight discharge, such as from closures or stitch holes, upon impact shall not be considered to be a failure of the IBC provided that no further leakage occurs after the IBC has been raised clear of the ground.
- .3 Rigid plastics, composite, fibreboard and wooden IBCs: no loss of contents. A slight discharge from a closure upon impact shall not be considered to be a failure of the IBC provided that no further leakage occurs.

*Part 6 – Construction and testing of packagings, IBCs, etc.*

---

.4 All IBCs: no damage which renders the IBC unsafe to be transported for salvage or for disposal, and no loss of contents. In addition, the IBC shall be capable of being lifted by an appropriate means until clear of the floor for five minutes.

**Note:** The criterion in 6.5.6.9.5.4 applies to design types for IBCs manufactured as from 1 January 2011.

**6.5.6.10 Tear test**

**6.5.6.10.1 Applicability**

For all types of flexible IBCs, as a design type test.

**6.5.6.10.2 Preparation of the IBC for test**

The IBC shall be filled to not less than 95% of its capacity and to its maximum permissible gross mass, the contents being evenly distributed.

**6.5.6.10.3 Method of testing**

Once the IBC is placed on the ground, a 100 mm knife score, completely penetrating the wall of a wide face, is made at a 45° angle to the principal axis of the IBC, halfway between the bottom surface and the top level of the contents. The IBC shall then be subjected to a uniformly distributed superimposed load equivalent to twice the maximum permissible gross mass. The load shall be applied for at least five minutes. An IBC which is designed to be lifted from the top or the side shall then, after removal of the superimposed load, be lifted until it is clear of the floor and maintained in that position for a period of five minutes.

**6.5.6.10.4 Criterion for passing the test**

The cut shall not propagate more than 25% of its original length.

**6.5.6.11 Topple test**

**6.5.6.11.1 Applicability**

For all types of flexible IBCs, as a design type test.

**6.5.6.11.2 Preparation of the IBC for test**

The IBC shall be filled to not less than 95% of its capacity and to its maximum permissible gross mass, the contents being evenly distributed.

**6.5.6.11.3 Method of testing**

The IBC shall be caused to topple onto any part of its top onto a rigid, non-resilient, smooth, flat and horizontal surface.

**6.5.6.11.4 Topple height**

Packing group I	Packing group II	Packing group III
1.8 m	1.2 m	0.8 m

**6.5.6.11.5 Criterion for passing the test**

No loss of contents. A slight discharge, such as from closures or stitch holes, upon impact shall not be considered to be a failure of the IBC provided that no further leakage occurs.

**6.5.6.12 Righting test**

**6.5.6.12.1 Applicability**

For all flexible IBCs designed to be lifted from the top or side, as a design type test.

**6.5.6.12.2 Preparation of the IBC for test**

The IBC shall be filled to not less than 95% of its capacity and its maximum permissible gross mass, the contents being evenly distributed.

**6.5.6.12.3 Method of testing**

The IBC, lying on its side, shall be lifted at a speed of 0.1 m/s to an upright position, clear of the floor, by one lifting device or by two lifting devices when four are provided.

**6.5.6.12.4 Criterion for passing the test**

No damage to the IBC or its lifting devices which renders the IBC unsafe for transport or handling.

**6.5.6.13 Vibration test**

**6.5.6.13.1 Applicability**

For all IBCs used for liquids, as a design type test.

**Note:** This test applies to design types for IBCs manufactured as from 1 January 2011.

**6.5.6.13.2 Preparation of the IBC for test**

A sample IBC shall be selected at random and shall be fitted and closed as for transport. The IBC shall be filled with water to not less than 98% of its maximum capacity.

**6.5.6.13.3 Test method and duration**

**6.5.6.13.3.1** The IBC shall be placed in the centre of the test machine platform with a vertical sinusoidal, double amplitude (peak-to-peak displacement) of 25 mm ± 5%. If necessary, restraining devices shall be attached to the platform to prevent the specimen from moving horizontally off the platform without restricting vertical movement.

**6.5.6.13.3.2** The test shall be conducted for one hour at a frequency that causes part of the base of the IBC to be momentarily raised from the vibrating platform for part of each cycle to such a degree that a metal shim can be completely inserted intermittently at, at least, one point between the base of the IBC and the test platform. The frequency may need to be adjusted after the initial set point to prevent the packaging from going into resonance. Nevertheless, the test frequency shall continue to allow placement of the metal shim under the IBC as described in this paragraph. The continuing ability to insert the metal shim is essential to passing the test. The metal shim used for this test shall be at least 1.6 mm thick, 50 mm wide, and be of sufficient length to be inserted between the IBC and the test platform a minimum of 100 mm to perform the test.

**6.5.6.13.4 Criteria for passing the test**

No leakage or rupture shall be observed. In addition, no breakage or failure of structural components, such as broken welds or failed fastenings, shall be observed.

**6.5.6.14 Test report**

**6.5.6.14.1** A test report containing at least the following particulars shall be drawn up and shall be available to the users of the IBC:

- .1 name and address of the test facility;
- .2 name and address of applicant (where appropriate);
- .3 a unique test report identification;
- .4 date of the test report;
- .5 manufacturer of the IBC;
- .6 description of the IBC design type (such as dimensions, materials, closures, thickness, etc.), including method of manufacture (such as blow-moulding), and which may include drawing(s) and/or photograph(s);
- .7 maximum capacity;
- .8 characteristics of test contents, such as viscosity and relative density for liquids and particle size for solids;
- .9 test descriptions and results; and
- .10 signature, with the name and status of the signatory.

**6.5.6.14.2** The test report shall contain statements that the IBC, prepared as for transport, was tested in accordance with the appropriate provisions of this chapter and that the use of other packaging methods or components may render it invalid. A copy of the test report shall be available to the competent authority.

## Chapter 6.6

### *Provisions for the construction and testing of large packagings*

#### 6.6.1 General

6.6.1.1 The provisions of this chapter do not apply to:

- class 2, except articles including aerosols;
- class 6.2, except clinical waste of UN 3291;
- class 7 packages containing radioactive material.

6.6.1.2 Large packagings shall be manufactured, tested and remanufactured under a quality-assurance programme which satisfies the competent authority in order to ensure that each manufactured or remanufactured large packaging meets the provisions of this chapter.

**Note:** ISO 16106:2006 “Packaging – Transport packages for dangerous goods – Dangerous goods packagings, intermediate bulk containers (IBCs) and large packagings – Guidelines for the application of ISO 9001” provides acceptable guidance on procedures which may be followed.

6.6.1.3 The specific requirements for large packagings in 6.6.4 are based on large packagings currently used. In order to take into account progress in science and technology, there is no objection to the use of large packagings having specifications different from those in 6.6.4 provided they are equally effective, acceptable to the competent authority and able successfully to withstand the tests described in 6.6.5. Methods of testing other than those prescribed in this Code are acceptable provided they are equivalent.

6.6.1.4 Manufacturers and subsequent distributors of packagings shall provide information regarding procedures to be followed and a description of the types and dimensions of closures (including required gaskets) and any other components needed to ensure that packages as presented for transport are capable of passing the applicable performance tests of this chapter.

#### 6.6.2 Code for designating types of large packagings

6.6.2.1 The code used for large packagings consists of:

- (a) two Arabic numerals:  
“50” for rigid large packagings; or  
“51” for flexible large packagings; and
- (b) capital letters in Latin characters indicating the nature of the material, such as wood, steel, etc. The capital letters used shall be those shown in 6.1.2.6.

6.6.2.2 The letter “W” may follow the large packaging code. The letter “W” signifies that the large packaging, although of the same type as indicated by the code, is manufactured to a specification different from those in 6.6.4 and is considered equivalent in accordance with the requirements in 6.6.1.3.

#### 6.6.3 Marking

##### 6.6.3.1 Primary marking

Each large packaging manufactured and intended for the use according to this Code shall bear markings which are durable, legible and placed in a location so as to be readily visible. Letters, numerals and symbols shall be at least 12 mm high and shall show:

- (a) The United Nations packaging symbol



This symbol shall not be used for any purpose other than certifying that a packaging, a flexible bulk container, a portable tank or a MEGC complies with the relevant requirements in Chapter 6.1, 6.2, 6.3, 6.5, 6.6, 6.7 or 6.9;





- (b) the code “50” designating a large rigid packaging or “51” for flexible large packagings, followed by the material type in accordance with 6.5.1.4.1.2;
- (c) a capital letter designating the packing group(s) for which the design type has been approved:  
“X” for packing groups I, II and III  
“Y” for packing groups II and III  
“Z” for packing group III only;
- (d) the month and year (last two digits) of manufacture;
- (e) the State authorizing the allocation of the marks, indicated by the distinguishing sign for motor vehicles in international traffic;
- (f) the name or symbol of the manufacturer and other identification of the large packagings as specified by the competent authority;
- (g) the stacking test load\* in kilograms. For large packagings not designed for stacking, the figure “0” shall be shown;
- (h) the maximum permissible gross mass in kilograms.

The primary marking required above shall be applied in the sequence of the subparagraphs. Each element of the marking applied in accordance with subparagraphs (a) to (h) shall be clearly separated, such as by a slash or space, so as to be easily identifiable.

**Note:** The size requirement for the primary marking shall apply for large packagings manufactured as from 1 January 2014.

**6.6.3.2 Examples of the marking**

	<p>50A/X/05 01/N/PQRS 2500/1000</p>	<p>For a large steel packaging suitable for stacking; stacking load: 2500 kg; maximum gross mass: 1000 kg.</p>
	<p>50H/Y/04 02/D/ABCD 987 0/800</p>	<p>For a large plastics packaging not suitable for stacking; maximum gross mass: 800 kg.</p>
	<p>51H/Z/06 01/S/1999 0/500</p>	<p>For a large flexible packaging not suitable for stacking; maximum gross mass: 500 kg.</p>

**6.6.3.3** The maximum permitted stacking load applicable when the large packaging is in use shall be displayed on a symbol as follows:

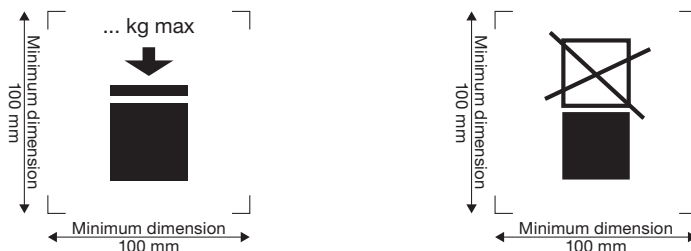

Large packaging capable of being stacked

Large packaging NOT capable of being stacked

The symbol shall be not less than 100 mm × 100 mm, be durable and clearly visible. The letters and numbers indicating the mass shall be at least 12 mm high.

The mass marked above the symbol shall not exceed the load imposed during the design type test (see 6.6.5.3.3.4) divided by 1.8.

**Note:** The provisions of 6.6.3.3 shall apply to all large packagings manufactured, repaired or remanufactured as from 1 January 2015.

\* The stacking test load in kilograms to be placed on the large packaging shall be 1.8 times the combined maximum permissible gross mass of the number of similar large packagings that may be stacked on top of the large packaging during transport (see 6.6.5.3.3.4).

**6.6.4 Specific provisions for large packagings****6.6.4.1 Specific provisions for metal large packagings**

- 50A steel
- 50B aluminium
- 50N metal (other than steel or aluminium)

6.6.4.1.1 The large packaging shall be made of suitable ductile metal in which the weldability has been fully demonstrated. Welds shall be skillfully made and afford complete safety. Low-temperature performance shall be taken into account when appropriate.

6.6.4.1.2 Care shall be taken to avoid damage by galvanic action due to the juxtaposition of dissimilar metals.

**6.6.4.2 Specific provisions for flexible material large packagings**

- 51H flexible plastics
- 51M flexible paper

6.6.4.2.1 The large packaging shall be manufactured from suitable materials. The strength of the material and the construction of the flexible large packaging shall be appropriate to its capacity and its intended use.

6.6.4.2.2 All materials used in the construction of flexible large packagings of types 51M shall, after complete immersion in water for not less than 24 hours, retain at least 85% of the tensile strength as measured originally on the material conditioned to equilibrium at 67% relative humidity or less.

6.6.4.2.3 Seams shall be formed by stitching, heat sealing, gluing or any equivalent method. All stitched seam-ends shall be secured.

6.6.4.2.4 Flexible large packagings shall provide adequate resistance to ageing and to degradation caused by ultraviolet radiation or the climatic conditions, or by the substance contained, thereby rendering them appropriate to their intended use.

6.6.4.2.5 For plastics flexible large packagings where protection against ultraviolet radiation is required, it shall be provided by the addition of carbon black or other suitable pigments or inhibitors. These additives shall be compatible with the contents and remain effective throughout the life of the large packaging. Where use is made of carbon black, pigments or inhibitors other than those used in the manufacture of the tested design type, re-testing may be waived if changes in the carbon black content, the pigment content or the inhibitor content do not adversely affect the physical properties of the material of construction.

6.6.4.2.6 Additives may be incorporated into the material of the large packaging to improve the resistance to ageing or to serve other purposes, provided that these do not adversely affect the physical or chemical properties of the material.

6.6.4.2.7 When filled, the ratio of height to width shall be not more than 2:1.

**6.6.4.3 Specific provisions for plastics large packagings**

- 50H rigid plastics

6.6.4.3.1 The large packaging shall be manufactured from suitable plastics material of known specifications and be of adequate strength in relation to its capacity and its intended use. The material shall be adequately resistant to ageing and to degradation caused by the substance contained or, where relevant, by ultraviolet radiation. Low-temperature performance shall be taken into account when appropriate. Any permeation of the substance contained shall not constitute a danger under normal conditions of transport.

6.6.4.3.2 Where protection against ultraviolet radiation is required, it shall be provided by the addition of carbon black or other suitable pigments or inhibitors. These additives shall be compatible with the contents and remain effective throughout the life of the outer packaging. Where use is made of carbon black, pigments or inhibitors other than those used in the manufacture of the tested design type, re-testing may be waived if changes in the carbon black content, the pigment content or the inhibitor content do not adversely affect the physical properties of the material of construction.

6.6.4.3.3 Additives may be incorporated into the material of the large packaging to improve the resistance to ageing or to serve other purposes, provided that these do not adversely affect the physical or chemical properties of the material.

**6.6.4.4 Specific provisions for fibreboard large packagings**

- 50G rigid fibreboard

- 6.6.4.4.1 Strong and good-quality solid or double-faced corrugated fibreboard (single or multiwall) shall be used, appropriate to the capacity of the large packagings and to their intended use. The water resistance of the outer surface shall be such that the increase in mass, as determined in a test carried out over a period of 30 minutes by the Cobb method of determining water absorption, is not greater than 155 g/m<sup>2</sup> – see ISO 535:1991. It shall have proper bending qualities. Fibreboard shall be cut, creased without scoring, and slotted so as to permit assembly without cracking, surface breaks or undue bending. The fluting of corrugated fibreboard shall be firmly glued to the facings.
- 6.6.4.4.2 The walls, including top and bottom, shall have a minimum puncture resistance of 15 J, measured according to ISO 3036:1975.
- 6.6.4.4.3 Manufacturing joints in the outer packaging of large packagings shall be made with an appropriate overlap and shall be taped, glued, stitched with metal staples or fastened by other means at least equally effective. Where joints are effected by gluing or taping, a water-resistant adhesive shall be used. Metal staples shall pass completely through all pieces to be fastened and be formed or protected so that any inner liner cannot be abraded or punctured by them.
- 6.6.4.4.4 Any integral pallet base forming part of a large packaging or any detachable pallet shall be suitable for mechanical handling with the large packaging filled to its maximum permissible gross mass.
- 6.6.4.4.5 The pallet or integral base shall be designed so as to avoid any protrusion of the base of the large packaging that might be liable to damage in handling.
- 6.6.4.4.6 The body shall be secured to any detachable pallet to ensure stability in handling and transport. Where a detachable pallet is used, its top surface shall be free from sharp protrusions that might damage the large packaging.
- 6.6.4.4.7 Strengthening devices such as timber supports to increase stacking performance may be used but shall be external to the liner.
- 6.6.4.4.8 Where large packagings are intended for stacking, the bearing surface shall be such as to distribute the load in a safe manner.
- 6.6.4.5 **Specific provisions for wooden large packagings**
- 50C natural wood
  - 50D plywood
  - 50F reconstituted wood
- 6.6.4.5.1 The strength of the materials used and the method of construction shall be appropriate to the capacity and intended use of the large packagings.
- 6.6.4.5.2 Natural wood shall be well seasoned, commercially dry and free from defects that would materially lessen the strength of any part of the large packaging. Each part of the large packaging shall consist of one piece or be equivalent thereto. Parts are considered equivalent to one piece when a suitable method of glued assembly is used, as for instance Lindermann joint, tongue and groove joint, ship lap or rabbet joint, or butt joint with at least two corrugated metal fasteners at each joint, or when other methods at least equally effective are used.
- 6.6.4.5.3 Large packagings of plywood shall be at least three-ply. They shall be made of well-seasoned rotary-cut, sliced or sawn veneer, commercially dry and free from defects that would materially lessen the strength of the large packaging. All adjacent plies shall be glued with water-resistant adhesive. Other suitable materials may be used with plywood for the construction of the large packaging.
- 6.6.4.5.4 Large packagings of reconstituted wood shall be made of water-resistant reconstituted wood such as hardboard, particle board or other suitable type.
- 6.6.4.5.5 Large packagings shall be firmly nailed or secured to corner posts or ends or be assembled by equally suitable devices.
- 6.6.4.5.6 Any integral pallet base forming part of a large packaging or any detachable pallet shall be suitable for mechanical handling with the large packaging filled to its maximum permissible gross mass.
- 6.6.4.5.7 The pallet or integral base shall be designed so as to avoid any protrusion of the base of the large packaging that might be liable to damage in handling.
- 6.6.4.5.8 The body shall be secured to any detachable pallet to ensure stability in handling and transport. Where a detachable pallet is used, its top surface shall be free from sharp protrusions that might damage the large packaging.
- 6.6.4.5.9 Strengthening devices such as timber supports to increase stacking performance may be used but shall be external to the liner.

## Part 6 – Construction and testing of packagings, IBCs, etc.

6.6.4.5.10 Where large packagings are intended for stacking, the bearing surface shall be such as to distribute the load in a safe manner.

## 6.6.5 Test provisions for large packagings

### 6.6.5.1 Performance and frequency of test

6.6.5.1.1 The design type of each large packaging shall be tested as provided in 6.6.5.3 in accordance with procedures established by the competent authority.

6.6.5.1.2 Each large packaging design type shall successfully pass the tests prescribed in this chapter before being used. A large packaging design type is defined by the design, size, material and thickness, manner of construction and packing, but may include various surface treatments. It also includes large packagings that differ from the design type only in their lesser design height.

6.6.5.1.3 Tests shall be repeated on production samples at intervals established by the competent authority. For such tests on fibreboard large packagings, preparation at ambient conditions is considered equivalent to the provisions of 6.6.5.2.4.

6.6.5.1.4 Tests shall also be repeated after each modification which alters the design, material or manner of construction of large packagings.

6.6.5.1.5 The competent authority may permit the selective testing of large packagings that differ only in minor respects from a tested type, such as smaller sizes of inner packagings or inner packagings of lower net mass, and large packagings which are produced with small reductions in external dimension(s).

6.6.5.1.6 [Reserved]

**Note:** For the conditions for assembling different inner packagings in a large packaging and permissible variations in inner packagings, see 4.1.1.5.1.

6.6.5.1.7 The competent authority may at any time require proof, by tests in accordance with this section, that serially produced large packagings meet the provisions of the design type tests.

6.6.5.1.8 Provided the validity of the test results is not affected, and with the approval of the competent authority, several tests may be made on one sample.

### 6.6.5.2 Preparation for testing

6.6.5.2.1 Tests shall be carried out on large packagings prepared as for transport, including the inner packagings or articles used. Inner packagings shall be filled to not less than 98% of their maximum capacity for liquids or 95% for solids. For large packagings where the inner packagings are designed to carry liquids and solids, separate testing is required for both liquid and solid contents. The substances in the inner packagings or the articles to be transported in the large packagings may be replaced by other material or articles except where this would invalidate the results of the tests. When other inner packagings or articles are used, they shall have the same physical characteristics (mass, etc.) as the inner packagings or articles to be carried. It is permissible to use additives, such as bags of lead shot, to achieve the requisite total package mass, so long as they are placed so that the test results are not affected.

6.6.5.2.2 In the drop tests for liquids, when another substance is used, it shall be of similar relative density and viscosity to those of the substance being transported. Water may also be used for the liquid drop test under the conditions in 6.6.5.3.4.4.

6.6.5.2.3 Large packagings made of plastics materials and large packagings containing inner packagings of plastic materials – other than bags intended to contain solids or articles – shall be drop tested when the temperature of the test sample and its contents has been reduced to  $-18^{\circ}\text{C}$  or lower. This conditioning may be disregarded if the materials in question are of sufficient ductility and tensile strength at low temperatures. Where test samples are prepared in this way, the conditioning in 6.6.5.2.4 may be waived. Test liquids shall be kept in the liquid state by the addition of anti-freeze if necessary.

6.6.5.2.4 Large packagings of fibreboard shall be conditioned for at least 24 hours in an atmosphere having a controlled temperature and relative humidity (r.h). There are three options, one of which shall be chosen. The preferred atmosphere is  $23^{\circ}\text{C}\pm 2^{\circ}\text{C}$  and  $50\%\pm 2\%$  r.h. The two other options are  $20^{\circ}\text{C}\pm 2^{\circ}\text{C}$  and  $65\%\pm 2\%$  r.h. or  $27^{\circ}\text{C}\pm 2^{\circ}\text{C}$  and  $65\%\pm 2\%$  r.h.

**Note:** Average values shall fall within these limits. Short-term fluctuation and measurement limitations may cause individual measurements to vary by up to  $\pm 5\%$  relative humidity without significant impairment of test reproducibility.

**6.6.5.3 Test provisions**

**6.6.5.3.1 Bottom lift test**

**6.6.5.3.1.1 Applicability**

For all types of large packagings which are fitted with means of lifting from the base, as a design type test.

**6.6.5.3.1.2 Preparation of large packaging for test**

The large packaging shall be filled to 1.25 times its maximum permissible gross mass, the load being evenly distributed.

**6.6.5.3.1.3 Method of testing**

The large packaging shall be raised and lowered twice by a lift truck with the forks centrally positioned and spaced at three quarters of the dimension of the side of entry (unless the points of entry are fixed). The forks shall penetrate to three quarters of the depth in the direction of entry. The test shall be repeated from each possible direction of entry.

**6.6.5.3.1.4 Criteria for passing the test**

No permanent deformation which renders the large packaging unsafe for transport and no loss of contents.

**6.6.5.3.2 Top lift test**

**6.6.5.3.2.1 Applicability**

For types of large packaging which are intended to be lifted from the top and fitted with means of lifting, as a design type test.

**6.6.5.3.2.2 Preparation of large packaging for test**

The large packaging shall be loaded to twice its maximum permissible gross mass. A flexible large packaging shall be loaded to six times its maximum permissible gross mass, the load being evenly distributed.

**6.6.5.3.2.3 Method of testing**

The large packaging shall be lifted in the manner for which it is designed until clear of the floor and maintained in that position for a period of five minutes.

**6.6.5.3.2.4 Criteria for passing the test**

- .1 Metal, rigid plastics and composite large packagings: no permanent deformation which renders the large packaging, including the base pallet, if any, unsafe for transport and no loss of contents.
- .2 Flexible large packagings: no damage to the large packaging or its lifting devices which renders the large packaging unsafe for transport or handling and no loss of contents.

**6.6.5.3.3 Stacking test**

**6.6.5.3.3.1 Applicability**

For all types of large packaging which are designed to be stacked on each other, as a design type test.

**6.6.5.3.3.2 Preparation of large packaging for test**

The large packaging shall be filled to its maximum permissible gross mass.

**6.6.5.3.3.3 Method of testing**

The large packaging shall be placed on its base on level hard ground and subjected to a uniformly distributed superimposed test load (see 6.6.5.3.3.4) for a period of at least five minutes: for large packaging of wood, fibreboard and plastics materials for a period of 24 hours.

**6.6.5.3.3.4 Calculation of superimposed test load**

The load to be placed on the large packaging shall be 1.8 times the combined maximum permissible gross mass of the number of similar large packagings that may be stacked on top of the large packaging during transport.

**6.6.5.3.3.5 Criteria for passing the test**

- .1 All types of large packagings other than flexible large packagings: no permanent deformation which renders the large packaging, including the base pallet, if any, unsafe for transport and no loss of contents.
- .2 Flexible large packagings: no deterioration of the body which renders the large packaging unsafe for transport and no loss of contents.

Part 6 – Construction and testing of packagings, IBCs, etc.

**6.6.5.3.4 Drop test**

**6.6.5.3.4.1 Applicability**

For all types of large packaging, as a design type test.

**6.6.5.3.4.2 Preparation of large packaging for testing**

The large packaging shall be filled in accordance with 6.6.5.2.1.

**6.6.5.3.4.3 Method of testing**

The large packaging shall be dropped onto a non-resilient, horizontal, flat, massive and rigid surface in conformity with the requirements of 6.1.5.3.4, in such a manner as to ensure that the point of impact is that part of the base of the large packaging considered to be the most vulnerable.

**6.6.5.3.4.4 Drop height**

**Note:** Large packagings for substances and articles of class 1 shall be tested at the packing group II performance level.

**6.6.5.3.4.4.1** For inner packagings containing solid or liquid substances or articles, if the test is performed with the solid, liquid or articles to be transported, or with another substance or article having essentially the same characteristics:

Packing group I	Packing group II	Packing group III
1.8 m	1.2 m	0.8 m

**6.6.5.3.4.4.2** For inner packagings containing liquids if the test is performed with water:

(a) Where the substances to be transported have a relative density not exceeding 1.2:

Packing group I	Packing group II	Packing group III
1.8 m	1.2 m	0.8 m

(b) Where the substances to be transported have a relative density exceeding 1.2, the drop height shall be calculated on the basis of the relative density (d) of the substance to be carried, rounded up to the first decimal, as follows:

Packing group I	Packing group II	Packing group III
$d \times 1.5$ (m)	$d \times 1.0$ (m)	$d \times 0.67$ (m)

**6.6.5.3.4.5 Criteria for passing the test**

**6.6.5.3.4.5.1** The large packaging shall not exhibit any damage liable to affect safety during transport. There shall be no leakage of the filling substance from inner packaging(s) or article(s).

**6.6.5.3.4.5.2** No rupture is permitted in a large packaging for articles of class 1 which would permit the spillage of loose explosive substances or articles from the large packaging.

**6.6.5.3.4.5.3** Where a large packaging undergoes a drop test, the sample passes the test if the entire contents are retained even if the closure is no longer sift-proof.

**6.6.5.4 Certification and test report**

**6.6.5.4.1** In respect of each design type of large packaging, a certificate and mark (as in 6.6.3) shall be issued attesting that the design type, including its equipment, meets the test provisions.

**6.6.5.4.2** A test report containing at least the following particulars shall be drawn up and shall be available to the users of the large packaging:

- .1 name and address of the test facility;
- .2 name and address of applicant (where appropriate);
- .3 a unique test report identification;
- .4 date of the test report;
- .5 manufacturer of the large packaging;
- .6 description of the large packaging design type (such as dimensions, materials, closures, thickness, etc.) and/or photograph(s);
- .7 maximum capacity/maximum permissible gross mass;

- .8 characteristics of test contents, such as types and descriptions of inner packaging or articles used;
- .9 test descriptions and results;
- .10 the test report shall be signed with the name and status of the signatory.

**6.6.5.4.3** The test report shall contain statements that the large packaging prepared as for transport was tested in accordance with the appropriate provisions of this chapter and that the use of other packaging methods or components may render it invalid. A copy of the test report shall be available to the competent authority.

## Chapter 6.7

### *Provisions for the design, construction, inspection and testing of portable tanks and multiple-element gas containers (MEGCs)*

**Note:** The provisions of this chapter also apply to road tank vehicles to the extent indicated in chapter 6.8.

#### **6.7.1 Application and general provisions**

- 6.7.1.1** The provisions of this chapter apply to portable tanks intended for the transport of dangerous goods, and to MEGCs intended for the transport of non-refrigerated gases of class 2, by all modes of transport. In addition to the provisions of this chapter, unless otherwise specified, the applicable provisions of the International Convention for Safe Containers (CSC) 1972, as amended, shall be fulfilled by any multimodal portable tank or MEGC which meets the definition of a "container" within the terms of that Convention. Additional provisions may apply to offshore portable tanks that are handled in open seas.
- 6.7.1.1.1** The International Convention for Safe Containers does not apply to offshore tank-containers that are handled in open seas. The design and testing of offshore tank-containers shall take into account the dynamic lifting and impact forces that may occur when a tank is handled in open seas in adverse weather and sea conditions. The provisions for such tanks shall be determined by the approving competent authority (see also MSC/Circ.860 "Guidelines for the approval of offshore containers handled in open seas").
- 6.7.1.2** In recognition of scientific and technological advances, the technical provisions of this chapter may be varied by alternative arrangements. These alternative arrangements shall offer a level of safety not less than that given by the provisions of this chapter with respect to the compatibility with substances transported and the ability of the portable tank to withstand impact, loading and fire conditions. For international transport, alternative arrangement portable tanks or MEGCs shall be approved by the applicable competent authorities.
- 6.7.1.3** When a substance is not assigned a portable tank instruction (T1 to T75) in the Dangerous Goods List in chapter 3.2, interim approval for transport may be issued by the competent authority of the country of origin. The approval shall be included in the documentation of the consignment and contain, as a minimum, the information normally provided in the portable tank instructions and the conditions under which the substance shall be transported. Appropriate measures shall be initiated by the competent authority to include the assignment in the Dangerous Goods List.

#### **6.7.2 Provisions for the design, construction, inspection and testing of portable tanks intended for the transport of substances of class 1 and classes 3 to 9**

##### **6.7.2.1 Definitions**

For the purposes of this section:

*Design pressure* means the pressure to be used in calculations required by a recognized pressure-vessel code. The design pressure shall be not less than the highest of the following pressures:

- .1 the maximum effective gauge pressure allowed in the shell during filling or discharge; or
- .2 the sum of:
  - .1 the absolute vapour pressure (in bar) of the substance at 65°C (or at the highest temperature during filling, discharge or transport for substances which are filled, discharged or transported over 65°C), minus 1 bar;
  - .2 the partial pressure (in bar) of air or other gases in the ullage space, being determined by a maximum ullage temperature of 65°C and a liquid expansion due to an increase in mean bulk temperature of  $t_r - t_f$  ( $t_f$  = filling temperature, usually 15°C;  $t_r$  = 50°C, maximum mean bulk temperature); and
  - .3 a head pressure determined on the basis of the static forces specified in 6.7.2.2.12, but not less than 0.35 bar.
- .3 two thirds of the minimum test pressure specified in the applicable portable tank instruction in 4.2.5.2.6;



Chapter 6.7 – Design, construction, inspection and testing of portable tanks & MEGCs

*Design temperature range* for the shell shall be  $-40^{\circ}\text{C}$  to  $50^{\circ}\text{C}$  for substances transported under ambient conditions. For the other substances filled, discharged or transported above  $50^{\circ}\text{C}$ , the design temperature shall not be less than the maximum temperature of the substance during filling, discharge or transport. More severe design temperatures shall be considered for portable tanks subjected to severe climatic conditions;

*Fine grain steel* means steel which has a ferritic grain size of 6 or finer when determined in accordance with ASTM E 112-96 or as defined in EN 10028-3, Part 3;

*Fusible element* means a non-reclosable pressure relief device that is thermally actuated;

*Leakproofness test* means a test using gas, subjecting the shell and its service equipment to an effective internal pressure of not less than 25% of the MAWP;

*Maximum allowable working pressure (MAWP)* means a pressure that shall be not less than the highest of the following pressures measured at the top of the shell while in operating position:

- .1 the maximum effective gauge pressure allowed in the shell during filling or discharge; or
- .2 the maximum effective gauge pressure to which the shell is designed, which shall be not less than the sum of:
  - .1 the absolute vapour pressure (in bar) of the substance at  $65^{\circ}\text{C}$  (or at the highest temperature during filling, discharge or transport for substances which are filled, discharged or transported over  $65^{\circ}\text{C}$ ) minus 1 bar; and
  - .2 the partial pressure (in bar) of air or other gases in the ullage space, being determined by a maximum ullage temperature of  $65^{\circ}\text{C}$  and a liquid expansion due to an increase in mean bulk temperature of  $t_r - t_f$  ( $t_f$  = filling temperature, usually  $15^{\circ}\text{C}$ ;  $t_r$  =  $50^{\circ}\text{C}$ , maximum mean bulk temperature);

*Maximum permissible gross mass (MPGM)* means the sum of the tare mass of the portable tank and the heaviest load authorized for transport;

*Mild steel* means a steel with a guaranteed minimum tensile strength of  $360\text{ N/mm}^2$  to  $440\text{ N/mm}^2$  and a guaranteed minimum elongation at fracture conforming to 6.7.2.3.3.3;

*Offshore portable tank* means a portable tank specially designed for repeated use for transport of dangerous goods to, from and between offshore facilities. An offshore portable tank is designed and constructed in accordance with MSC/Circ.860 "Guidelines for the approval of containers handled in open seas";

*Portable tank* means a multimodal tank used for the transport of substances of class 1 and classes 3 to 9. The portable tank includes a shell fitted with service equipment and structural equipment necessary for the transport of dangerous substances. The portable tank shall be capable of being filled and discharged without the removal of its structural equipment. It shall possess stabilizing members external to the shell, and shall be capable of being lifted when full. It shall be designed primarily to be loaded onto a vehicle or ship and shall be equipped with skids, mountings or accessories to facilitate mechanical handling. Road tank-vehicles, rail tank-wagons, non-metallic tanks and intermediate bulk containers (IBCs) are not considered to fall within the definition for portable tanks;

*Reference steel* means a steel with a tensile strength of  $370\text{ N/mm}^2$  and an elongation at fracture of 27%;

*Service equipment* means measuring instruments and filling, discharge, venting, safety, heating, cooling and insulating devices;

*Shell* means the part of the portable tank which retains the substance intended for transport (tank proper), including openings and their closures, but does not include service equipment or external structural equipment;

*Structural equipment* means the reinforcing, fastening, protective and stabilizing members external to the shell;

*Test pressure* means the maximum gauge pressure at the top of the shell during the hydraulic pressure test, equal to not less than 1.5 times the design pressure. The minimum test pressure for portable tanks intended for specific substances is specified in the applicable portable tank instruction in 4.2.5.2.6.

### 6.7.2.2 General design and construction provisions

- 6.7.2.2.1 Shells shall be designed and constructed in accordance with the provisions of a pressure-vessel code recognized by the competent authority. Shells shall be made of metallic materials suitable for forming. The materials shall, in principle, conform to national or international material standards. For welded shells, only a material whose weldability has been fully demonstrated shall be used. Welds shall be skillfully made and afford complete safety. When the manufacturing process or the materials make it necessary, the shells shall be suitably heat-treated to guarantee adequate toughness in the weld and in the heat-affected zones. In choosing the material, the design temperature range shall be taken into account with respect to risk of brittle

Part 6 – Construction and testing of packagings, IBCs, etc.

---

fracture, to stress corrosion cracking and to resistance to impact. When fine grain-steel is used, the guaranteed value of the yield strength shall be not more than 460 N/mm<sup>2</sup> and the guaranteed value of the upper limit of the tensile strength shall be not more than 725 N/mm<sup>2</sup> according to the material specification. Aluminium may only be used as a construction material when indicated in a portable tank special provision assigned to a specific substance in the Dangerous Goods List or when approved by the competent authority. When aluminium is authorized, it shall be insulated to prevent significant loss of physical properties when subjected to a heat load of 110 kW/m<sup>2</sup> for a period of not less than 30 minutes. The insulation shall remain effective at all temperatures less than 649°C and shall be jacketed with a material with a melting point of not less than 700°C. Portable tank materials shall be suitable for the external environment in which they may be transported.

- 6.7.2.2.2 Portable tank shells, fittings, and pipework shall be constructed from materials which are:
- .1 substantially immune to attack by the substance(s) intended to be transported; or
  - .2 properly passivated or neutralized by chemical reaction; or
  - .3 lined with corrosion-resistant material directly bonded to the shell or attached by equivalent means.
- 6.7.2.2.3 Gaskets shall be made of materials not subject to attack by the substance(s) intended to be transported.
- 6.7.2.2.4 When shells are lined, the lining shall be substantially immune to attack by the substance(s) intended to be transported, homogeneous, non-porous, free from perforations, sufficiently elastic and compatible with the thermal expansion characteristics of the shell. The lining of every shell, shell fittings and piping shall be continuous, and shall extend around the face of any flange. Where external fittings are welded to the tank, the lining shall be continuous through the fitting and around the face of external flanges.
- 6.7.2.2.5 Joints and seams in the lining shall be made by fusing the material together or by other equally effective means.
- 6.7.2.2.6 Contact between dissimilar metals which could result in damage by galvanic action shall be avoided.
- 6.7.2.2.7 The materials of the portable tank, including any devices, gaskets, linings and accessories, shall not adversely affect the substance(s) intended to be transported in the portable tank.
- 6.7.2.2.8 Portable tanks shall be designed and constructed with supports to provide a secure base during transport and with suitable lifting and tie-down attachments.
- 6.7.2.2.9 Portable tanks shall be designed to withstand, without loss of contents, at least the internal pressure due to the contents and the static, dynamic and thermal loads during normal conditions of handling and transport. The design shall demonstrate that the effects of fatigue, caused by repeated application of these loads through the expected life of the portable tank, have been taken into account.
- 6.7.2.2.9.1 For portable tanks that are intended for use as offshore tank-containers, the dynamic stresses imposed by handling in open seas shall be taken into account.
- 6.7.2.2.10 A shell which is to be equipped with a vacuum-relief device shall be designed to withstand, without permanent deformation, an external pressure of not less than 0.21 bar above the internal pressure. The vacuum-relief device shall be set to relieve at a vacuum setting not greater than –0.21 bar unless the shell is designed for a higher external overpressure, in which case the vacuum-relief pressure of the device to be fitted shall be not greater than the tank design vacuum pressure. A shell used for the transport of solid substances of packing groups II or III only which do not liquefy during transport may be designed for a lower external pressure, subject to competent authority's approval. In this case, the vacuum-relief device shall be set to relieve at this lower pressure. A shell that is not to be fitted with a vacuum-relief device shall be designed to withstand, without permanent deformation, an external pressure of not less than 0.4 bar above the internal pressure.
- 6.7.2.2.11 Vacuum-relief devices used on portable tanks intended for the transport of substances meeting the flash-point criteria of class 3, including elevated-temperature substances transported at or above their flashpoint, shall prevent the immediate passage of flame into the shell, or the portable tank shall have a shell capable of withstanding, without leakage, an internal explosion resulting from the passage of flame into the shell.
- 6.7.2.2.12 Portable tanks and their fastenings shall, under the maximum permissible load, be capable of absorbing the following separately applied static forces:
- .1 in the direction of travel: twice the MPGM multiplied by the acceleration due to gravity ( $g$ );\*
  - .2 horizontally at right angles to the direction of travel: the MPGM (when the direction of travel is not clearly determined, the forces shall be equal to twice the MPGM) multiplied by the acceleration due to gravity ( $g$ );\*
  - .3 vertically upwards: the MPGM multiplied by the acceleration due to gravity ( $g$ );\* and

\* For calculation purposes,  $g = 9.81 \text{ m/s}^2$ .

- .4 vertically downwards: twice the MPGM (total loading including the effect of gravity) multiplied by the acceleration due to gravity ( $g$ )\*.
- 6.7.2.2.13 Under each of the forces in 6.7.2.2.12, the safety factor to be observed shall be as follows:
- .1 for metals having a clearly defined yield point, a safety factor of 1.5 in relation to the guaranteed yield strength; or
  - .2 for metals with no clearly defined yield point, a safety factor of 1.5 in relation to the guaranteed 0.2% proof strength and, for austenitic steels, the 1% proof strength.
- 6.7.2.2.14 The value of yield strength or proof strength shall be the value according to national or international material standards. When austenitic steels are used, the specified minimum values of yield strength or proof strength according to the material standards may be increased by up to 15% when these greater values are attested in the material inspection certificate. When no material standard exists for the metal in question, the value of yield strength or proof strength used shall be approved by the competent authority.
- 6.7.2.2.15 Portable tanks shall be capable of being electrically earthed when intended for the transport of substances meeting the flashpoint criteria of class 3, including elevated-temperature substances transported above their flashpoint. Measures shall be taken to prevent dangerous electrostatic discharge.
- 6.7.2.2.16 When required for certain substances by the applicable portable tank instruction indicated in column 13 of the Dangerous Goods List, or by a portable tank special provision indicated in column 14, portable tanks shall be provided with additional protection, which may take the form of additional shell thickness or a higher test pressure, the additional shell thickness or higher test pressure being determined in the light of the inherent risks associated with the transport of the substances concerned.
- 6.7.2.2.17 Thermal insulation directly in contact with the shell intended for substances transported at elevated temperature shall have an ignition temperature at least 50°C higher than the maximum design temperature of the tank.
- 6.7.2.3 Design criteria**
- 6.7.2.3.1 Shells shall be of a design capable of being stress-analysed mathematically or experimentally by resistance strain gauges, or by other methods approved by the competent authority.
- 6.7.2.3.2 Shells shall be designed and constructed to withstand a hydraulic test pressure not less than 1.5 times the design pressure. Specific provisions are laid down for certain substances in the applicable portable tank instruction indicated in column 13 of the Dangerous Goods List and described in 4.2.5 or by a portable tank special provision indicated in column 14 of the Dangerous Goods List and described in 4.2.5.3. The minimum shell thickness shall not be less than that specified for these tanks in 6.7.2.4.1 to 6.7.2.4.10.
- 6.7.2.3.3 For metals exhibiting a clearly defined yield point or characterized by a guaranteed proof strength (0.2% proof strength, generally, or 1% proof strength for austenitic steels), the primary membrane stress  $\sigma$  (sigma) in the shell shall not exceed  $0.75R_e$  or  $0.50R_m$ , whichever is lower, at the test pressure, where:
- $$R_e = \text{yield strength in N/mm}^2, \text{ or } 0.2\% \text{ proof strength or, for austenitic steels, } 1\% \text{ proof strength;}$$
- $$R_m = \text{minimum tensile strength in N/mm}^2.$$
- 6.7.2.3.3.1 The values of  $R_e$  and  $R_m$  to be used shall be the specified minimum values according to national or international material standards. When austenitic steels are used, the specified minimum values for  $R_e$  and  $R_m$  according to the material standards may be increased by up to 15% when these greater values are attested in the material inspection certificate. When no material standard exists for the metal in question, the values of  $R_e$  and  $R_m$  used shall be approved by the competent authority or its authorized body.
- 6.7.2.3.3.2 Steels which have a  $R_e/R_m$  ratio of more than 0.85 are not allowed for the construction of welded shells. The values of  $R_e$  and  $R_m$  to be used in determining this ratio shall be the values specified in the material inspection certificate.
- 6.7.2.3.3.3 Steels used in the construction of shells shall have an elongation at fracture, in %, of not less than  $10,000/R_m$  with an absolute minimum of 16% for fine-grain steels and 20% for other steels. Aluminium and aluminium alloys used in the construction of shells shall have an elongation at fracture, in %, of not less than  $10,000/6R_m$  with an absolute minimum of 12%.
- 6.7.2.3.3.4 For the purpose of determining actual values for materials, it shall be noted that for sheet metal, the axis of the tensile test specimen shall be at right angles (transversely) to the direction of rolling. The permanent elongation at fracture shall be measured on test specimens of rectangular cross-section in accordance with ISO 6892:1998 using a 50 mm gauge length.
- 6.7.2.4 Minimum shell thickness**
- 6.7.2.4.1 The minimum shell thickness shall be the greater thickness based on:

Part 6 – Construction and testing of packagings, IBCs, etc.

- .1 the minimum thickness determined in accordance with the provisions of 6.7.2.4.2 to 6.7.2.4.10;
- .2 the minimum thickness determined in accordance with the recognized pressure-vessel code, including the provisions in 6.7.2.3; and
- .3 the minimum thickness specified in the applicable portable tank instruction indicated in column 13 of the Dangerous Goods List, or by a portable tank special provision indicated in column 14.

6.7.2.4.2 The cylindrical portions, ends (heads) and manhole covers of shells not more than 1.80 m in diameter shall be not less than 5 mm thick in the reference steel or of equivalent thickness in the metal to be used. Shells more than 1.80 m in diameter shall be not less than 6 mm thick in the reference steel or of equivalent thickness in the metal to be used, except that for powdered or granular solid substances of packing group II or III the minimum thickness requirement may be reduced to not less than 5 mm thick in the reference steel or of equivalent thickness in the metal to be used.

6.7.2.4.3 When additional protection against shell damage is provided, portable tanks with test pressures less than 2.65 bar may have the minimum shell thickness reduced, in proportion to the protection provided, as approved by the competent authority. However, shells not more than 1.80 m in diameter shall be not less than 3 mm thick in the reference steel or of equivalent thickness in the metal to be used. Shells more than 1.80 m in diameter shall be not less than 4 mm thick in the reference steel or of equivalent thickness in the metal to be used.

6.7.2.4.4 The cylindrical portions, ends (heads) and manhole covers of all shells shall be not less than 3 mm thick regardless of the material of construction.

6.7.2.4.5 The additional protection referred to in 6.7.2.4.3 may be provided by overall external structural protection, such as suitable “sandwich” construction with the outer sheathing (jacket) secured to the shell, double-wall construction or by enclosing the shell in a complete framework with longitudinal and transverse structural members.

6.7.2.4.6 The equivalent thickness of a metal other than the thickness prescribed for the reference steel in 6.7.2.4.3 shall be determined using the following equation:

$$e_1 = \frac{21.4 \times e_0}{\sqrt[3]{R_{m1} \times A_1}}$$

where:

- $e_1$  = required equivalent thickness (in mm) of the metal to be used;
- $e_0$  = minimum thickness (in mm) of the reference steel specified in the applicable portable tank instruction or by a portable tank special provision indicated in column 13 or 14 of the Dangerous Goods List;
- $R_{m1}$  = guaranteed minimum tensile strength (in N/mm<sup>2</sup>) of the metal to be used (see 6.7.2.3.3);
- $A_1$  = guaranteed minimum elongation at fracture (in %) of the metal to be used according to national or international standards.

6.7.2.4.7 When, in the applicable portable tank instruction in 4.2.5.2.6, a minimum thickness of 8 mm, 10 mm or 12 mm is specified, it shall be noted that these thicknesses are based on the properties of the reference steel and a shell diameter of 1.80 m. When a metal other than mild steel (see 6.7.2.1) is used or the shell has a diameter of more than 1.80 m, the thickness shall be determined using the following equation:

$$e_1 = \frac{21.4 \times e_0 d_1}{1.8^2 \sqrt[3]{R_{m1} \times A_1}}$$

where:

- $e_1$  = required equivalent thickness (in mm) of the metal to be used;
- $e_0$  = minimum thickness (in mm) of the reference steel specified in the applicable portable tank instruction or by a portable tank special provision indicated in column 13 or 14 of the Dangerous Goods List;
- $d_1$  = diameter of the shell (in m), but not less than 1.80 m;
- $R_{m1}$  = guaranteed minimum tensile strength (in N/mm<sup>2</sup>) of the metal to be used (see 6.7.2.3.3);
- $A_1$  = guaranteed minimum elongation at fracture (in %) of the metal to be used according to national or international standards.

6.7.2.4.8 In no case shall the wall thickness be less than that prescribed in 6.7.2.4.2, 6.7.2.4.3 and 6.7.2.4.4. All parts of the shell shall have a minimum thickness as determined by 6.7.2.4.2 to 6.7.2.4.4. This thickness shall be exclusive of any corrosion allowance.

6.7.2.4.9 When mild steel is used (see 6.7.2.1), calculation using the equation in 6.7.2.4.6 is not required.

6.7.2.4.10 There shall be no sudden change of plate thickness at the attachment of the ends (heads) to the cylindrical portion of the shell.

**6.7.2.5 Service equipment**

- 6.7.2.5.1** Service equipment shall be so arranged as to be protected against the risk of being wrenched off or damaged during handling and transport. When the connection between the frame and the shell allows relative movement between the sub-assemblies, the equipment shall be so fastened as to permit such movement without risk of damage to working parts. The external discharge fittings (pipe sockets, shut-off devices), the internal stop-valve and its seating shall be protected against the danger of being wrenched off by external forces (for example, by using shear sections). The filling and discharge devices (including flanges or threaded plugs) and any protective caps shall be capable of being secured against unintended opening.
- 6.7.2.5.1.1** For offshore tank-containers, where positioning of service equipment and the design and strength of protection for such equipment is concerned, the increased danger of impact damage when handling such tanks in open seas shall be taken into account.
- 6.7.2.5.2** All openings in the shell, intended for filling or discharging the portable tank, shall be fitted with a manually operated stop-valve located as close to the shell as reasonably practicable. Other openings, except for openings leading to venting or pressure relief devices, shall be equipped with either a stop-valve or another suitable means of closure located as close to the shell as reasonably practicable.
- 6.7.2.5.3** All portable tanks shall be fitted with a manhole or other inspection openings of a suitable size to allow for internal inspection and adequate access for maintenance and repair of the interior. Compartmented portable tanks shall have a manhole or other inspection openings for each compartment.
- 6.7.2.5.4** As far as reasonably practicable, external fittings shall be grouped together. For insulated portable tanks, top fittings shall be surrounded by a spill-collection reservoir with suitable drains.
- 6.7.2.5.5** Each connection to a portable tank shall be clearly marked to indicate its function.
- 6.7.2.5.6** Each stop-valve or other means of closure shall be designed and constructed to a rated pressure not less than the MAWP of the shell, taking into account the temperatures expected during transport. All stop-valves with screwed spindles shall close by a clockwise motion of the handwheel. For other stop-valves, the position (open and closed) and direction of closure shall be clearly indicated. All stop-valves shall be designed to prevent unintentional opening.
- 6.7.2.5.7** No moving parts, such as covers, components of closures, etc., shall be made of unprotected corrodible steel when they are liable to come into frictional or percussive contact with aluminium portable tanks intended for the transport of substances meeting the flashpoint criteria of class 3, including elevated-temperature substances transported above their flashpoint.
- 6.7.2.5.8** Piping shall be designed, constructed and installed so as to avoid the risk of damage due to thermal expansion and contraction, mechanical shock and vibration. All piping shall be of a suitable metallic material. Welded pipe joints shall be used wherever possible.
- 6.7.2.5.9** Joints in copper tubing shall be brazed or have an equally strong metal union. The melting point of brazing materials shall be no lower than 525°C. The joints shall not decrease the strength of the tubing, as may happen when cutting threads.
- 6.7.2.5.10** The burst pressure of all piping and pipe fittings shall be not less than the highest of four times the MAWP of the shell or four times the pressure to which it may be subjected in service by the action of a pump or other device (except pressure relief devices).
- 6.7.2.5.11** Ductile metals shall be used in the construction of valves and accessories.
- 6.7.2.5.12** The heating system shall be designed or controlled so that a substance cannot reach a temperature at which the pressure in the tank exceeds its MAWP or causes other hazards (e.g., dangerous thermal decomposition).
- 6.7.2.5.13** The heating system shall be designed or controlled so that power for internal heating elements is not available unless the heating elements are completely submerged. The temperature at the surface of the heating elements for internal heating equipment or the temperature at the shell for external heating equipment shall, in no case, exceed 80% of the auto-ignition temperature (in °C) of the substances carried.
- 6.7.2.5.14** If an electrical heating system is installed inside the tank, it shall be equipped with an earth leakage circuit breaker with a releasing current of less than 100 mA.
- 6.7.2.5.15** Electrical switch cabinets mounted to tanks shall not have a direct connection to the tank interior and shall provide protection of at least the equivalent of IP 56 according to IEC 144 or IEC 529.
- 6.7.2.6 Bottom openings**
- 6.7.2.6.1** Certain substances shall not be transported in portable tanks with bottom openings. When the applicable portable tank instruction identified in the Dangerous Goods List and described in 4.2.5.2.6 indicates that bottom openings are prohibited, there shall be no openings below the liquid level of the shell when it is filled

Part 6 – Construction and testing of packagings, IBCs, etc.

---

to its maximum permissible filling limit. When an existing opening is closed, it shall be accomplished by internally and externally welding one plate to the shell.

6.7.2.6.2 Bottom discharge outlets for portable tanks carrying certain solid, crystallizable or highly viscous substances shall be equipped with not less than two serially fitted and mutually independent shut-off devices. The design of the equipment shall be to the satisfaction of the competent authority or its authorized body and shall include:

- .1 an external stop-valve, fitted as close to the shell as reasonably practicable, and so designed as to prevent any unintended opening through impact or other inadvertent act; and
- .2 a liquid-tight closure at the end of the discharge pipe, which may be a bolted blank flange or a screw cap.

6.7.2.6.3 Every bottom discharge outlet, except as provided in 6.7.2.6.2, shall be equipped with three serially fitted and mutually independent shut-off devices. The design of the equipment shall be to the satisfaction of the competent authority or its authorized body and include:

- .1 a self-closing internal stop-valve, that is a stop-valve within the shell or within a welded flange or its companion flange, such that:
  - .1 the control devices for the operation of the valve are designed so as to prevent any unintended opening through impact or other inadvertent act;
  - .2 the valve may be operable from above or below;
  - .3 if possible, the setting of the valve (open or closed) shall be capable of being verified from the ground;
  - .4 except for portable tanks having a capacity of not more than 1000 ℓ, it shall be possible to close the valve from an accessible position of the portable tank that is remote from the valve itself; and
  - .5 the valve shall continue to be effective in the event of damage to the external device for controlling the operation of the valve;
- .2 an external stop-valve fitted as close to the shell as reasonably practicable; and
- .3 a liquid-tight closure at the end of the discharge pipe, which may be a bolted blank flange or a screw cap.

6.7.2.6.4 For a lined shell, the internal stop-valve required by 6.7.2.6.3.1 may be replaced by an additional external stop-valve. The manufacturer shall satisfy the provisions of the competent authority or its authorized body.

6.7.2.7 **Safety relief devices**

6.7.2.7.1 All portable tanks shall be fitted with at least one pressure relief device. All relief devices shall be designed, constructed and marked to the satisfaction of the competent authority or its authorized body.

6.7.2.8 **Pressure relief devices**

6.7.2.8.1 Every portable tank with a capacity not less than 1900 ℓ and every independent compartment of a portable tank with a similar capacity shall be provided with one or more pressure relief devices of the spring-loaded type and may in addition have a frangible disc or fusible element in parallel with the spring-loaded devices except when prohibited by reference to 6.7.2.8.3 in the applicable portable tank instruction in 4.2.5.2.6. The pressure relief devices shall have sufficient capacity to prevent rupture of the shell due to over-pressurization or vacuum resulting from filling, from discharging, or from heating of the contents.

6.7.2.8.2 Pressure relief devices shall be designed to prevent the entry of foreign matter, the leakage of liquid and the development of any dangerous excess pressure.

6.7.2.8.3 When required for certain substances by the applicable portable tank instruction identified in the Dangerous Goods List and described in 4.2.5.2.6, portable tanks shall have a pressure relief device approved by the competent authority. Unless a portable tank in dedicated service is fitted with an approved relief device constructed of materials compatible with the load, the relief device shall comprise a frangible disc preceding a spring-loaded pressure relief device. When a frangible disc is inserted in series with the required pressure relief device, the space between the frangible disc and the pressure relief device shall be provided with a pressure gauge or suitable tell-tale indicator for the detection of disc rupture, pinholing, or leakage which could cause a malfunction of the pressure relief system. The frangible disc shall rupture at a nominal pressure 10% above the start-to-discharge pressure of the relief device.

6.7.2.8.4 Every portable tank with a capacity less than 1900 ℓ shall be fitted with a pressure relief device, which may be a frangible disc when this disc complies with the provisions of 6.7.2.11.1. When no spring-loaded pressure relief device is used, the frangible disc shall be set to rupture at a nominal pressure equal to the test pressure. In addition, fusible elements conforming to 6.7.2.10.1 may also be used.

6.7.2.8.5 When the shell is fitted for pressure discharge, the inlet line shall be provided with a suitable pressure relief device set to operate at a pressure not higher than the MAWP of the shell, and a stop-valve shall be fitted as close to the shell as reasonably practicable.

**6.7.2.9 Setting of pressure relief devices**

**6.7.2.9.1** It shall be noted that the pressure relief devices shall operate only in conditions of excessive rise in temperature, since the shell shall not be subject to undue fluctuations of pressure during normal conditions of transport (see 6.7.2.12.2).

**6.7.2.9.2** The required pressure relief device shall be set to start to discharge at a nominal pressure of five sixths of the test pressure for shells having a test pressure of not more than 4.5 bar and 110% of two thirds of the test pressure for shells having a test pressure of more than 4.5 bar. After discharge, the device shall close at a pressure not more than 10% below the pressure at which the discharge starts. The device shall remain closed at all lower pressures. This requirement does not prevent the use of vacuum relief or combination pressure relief and vacuum relief devices.

**6.7.2.10 Fusible elements**

**6.7.2.10.1** Fusible elements shall operate at a temperature between 100°C and 149°C on condition that the pressure in the shell at the fusing temperature will be not more than the test pressure. They shall be placed at the top of the shell with their inlets in the vapour space, and when used for transport safety purposes, they shall not be shielded from external heat. Fusible elements shall not be used on portable tanks with a test pressure which exceeds 2.65 bar unless specified by special provision TP36 in column 14 of the Dangerous Goods List of chapter 3.2. Fusible elements used on portable tanks intended for the transport of elevated-temperature substances shall be designed to operate at a temperature higher than the maximum temperature that will be experienced during transport and shall be to the satisfaction of the competent authority or its authorized body.

**6.7.2.11 Frangible discs**

**6.7.2.11.1** Except as specified in 6.7.2.8.3, frangible discs shall be set to rupture at a nominal pressure equal to the test pressure throughout the design temperature range. Particular attention shall be given to the provisions of 6.7.2.5.1 and 6.7.2.8.3 if frangible discs are used.

**6.7.2.11.2** Frangible discs shall be appropriate for the vacuum pressures which may be produced in the portable tank.

**6.7.2.12 Capacity of pressure relief devices**

**6.7.2.12.1** The spring-loaded pressure relief device required by 6.7.2.8.1 shall have a minimum cross-sectional flow area equivalent to an orifice of 31.75 mm diameter. Vacuum relief devices, when used, shall have a cross-sectional flow area not less than 284 mm<sup>2</sup>.

**6.7.2.12.2** The combined delivery capacity of the pressure relief system (taking into account the reduction of the flow when the portable tank is fitted with frangible discs preceding spring-loaded pressure relief devices or when the spring-loaded pressure relief devices are provided with a device to prevent the passage of the flame), in conditions of complete fire engulfment of the portable tank shall be sufficient to limit the pressure in the shell to 20% above the start-to-discharge pressure of the pressure-limiting device. Emergency pressure relief devices may be used to achieve the full relief capacity prescribed. These devices may be fusible, spring-loaded or frangible disc components, or a combination of spring-loaded and frangible disc devices. The total required capacity of the relief devices may be determined using the formula in 6.7.2.12.2.1 or the table in 6.7.2.12.2.3.

**6.7.2.12.2.1** To determine the total required capacity of the relief devices, which shall be regarded as being the sum of the individual capacities of all the contributing devices, the following formula shall be used:

$$Q = 12.4 \frac{FA^{0.82}}{LC} \sqrt{\frac{ZT}{M}}$$

where:

**Q** = minimum required rate of discharge in cubic metres of air per second (m<sup>3</sup>/s) at standard conditions: 1 bar and 0°C (273 K);

**F** = a coefficient with the following value:

for uninsulated shells,  $F = 1$

for insulated shells,  $F = U(649 - t)/13.6$  but in no case is less than 0.25

where:

**U** = thermal conductance of the insulation, in kW·m<sup>-2</sup>·K<sup>-1</sup>, at 38°C;

**t** = actual temperature of the substance during filling (in °C) (when this temperature is unknown, let  $t = 15$ °C);

The value of **F** given above for insulated shells may be taken provided that the insulation is in conformance with 6.7.2.12.2.4;

**Part 6 – Construction and testing of packagings, IBCs, etc.**

- A = total external surface area of shell in square metres;
- Z = the gas compressibility factor in the accumulating condition (when this factor is unknown, let Z equal 1.0);
- T = absolute temperature in kelvin (°C + 273) above the pressure relief devices in the accumulating condition;
- L = the latent heat of vaporization of the liquid, in kJ/kg, in the accumulating condition;
- M = molecular mass of the discharged gas;
- C = a constant which is derived from one of the following formulae as a function of the ratio *k* of specific heats:

$$k = \frac{C_p}{C_v}$$

where:

*C<sub>p</sub>* = specific heat at constant pressure; and

*C<sub>v</sub>* = specific heat at constant volume.

When *k* > 1:

$$C = \sqrt{k \left( \frac{2}{k+1} \right)^{\frac{k+1}{k-1}}}$$

When *k* = 1 or *k* is unknown:

$$C = \frac{1}{\sqrt{e}} = 0.607$$

where *e* is the mathematical constant 2.7183.

C may also be taken from the following table:

<i>k</i>	<i>C</i>	<i>k</i>	<i>C</i>	<i>k</i>	<i>C</i>
1.00	0.607	1.26	0.660	1.52	0.704
1.02	0.611	1.28	0.664	1.54	0.707
1.04	0.615	1.30	0.667	1.56	0.71
1.06	0.620	1.32	0.671	1.58	0.713
1.08	0.624	1.34	0.674	1.60	0.716
1.10	0.628	1.36	0.678	1.62	0.719
1.12	0.633	1.38	0.681	1.64	0.722
1.14	0.637	1.40	0.685	1.66	0.725
1.16	0.641	1.42	0.688	1.68	0.728
1.18	0.645	1.44	0.691	1.70	0.731
1.20	0.649	1.46	0.695	2.0	0.77
1.22	0.652	1.48	0.698	2.2	0.793
1.24	0.656	1.50	0.701		

6.7.2.12.2.2 As an alternative to the formula above, shells designed for the transport of liquids may have their relief devices sized in accordance with the table in 6.7.2.12.2.3. This table assumes an insulation value of *F* = 1 and shall be adjusted accordingly when the shell is insulated. Other values used in determining this table are:

$$M = 86.7; \quad T = 394 \text{ K}; \quad L = 334.94 \text{ kJ/kg}; \quad C = 0.607; \quad Z = 1$$

6.7.2.12.2.3 Minimum required rate of discharge, *Q*, in cubic metres of air per second at 1 bar and 0°C (273 K):

A Exposed area (square metres)	Q (cubic metres of air per second)	A Exposed area (square metres)	Q (cubic metres of air per second)
2	0.230	14	1.132
3	0.320	16	1.263
4	0.405	18	1.391
5	0.487	20	1.517
6	0.565	22.5	1.670
7	0.641	25	1.821
8	0.715	27.5	1.969
9	0.788	30	2.115
10	0.859	32.5	2.258
12	0.998	35	2.400



A Exposed area (square metres)	Q (cubic metres of air per second)	A Exposed area (square metres)	Q (cubic metres of air per second)
37.5	2.539	62.5	3.860
40	2.677	65	3.987
42.5	2.814	67.5	4.112
45	2.949	70	4.236
47.5	3.082	75	4.483
50	3.215	80	4.726
52.5	3.346	85	4.967
55	3.476	90	5.206
57.5	3.605	95	5.442
60	3.733	100	5.676

6.7.2.12.2.4 Insulation systems, used for the purpose of reducing venting capacity, shall be approved by the competent authority or its authorized body. In all cases, insulation systems approved for this purpose shall:

- (a) remain effective at all temperatures up to 649°C; and
- (b) be jacketed with a material having a melting point of 700°C or greater.

**6.7.2.13 Marking of pressure relief devices**

6.7.2.13.1 Every pressure relief device shall be clearly and permanently marked with the following:

- .1 the pressure (in bar or kPa) or temperature (in °C) at which it is set to discharge;
- .2 the allowable tolerance at the discharge pressure, for spring-loaded devices;
- .3 the reference temperature corresponding to the rated pressure, for frangible discs;
- .4 the allowable temperature tolerance, for fusible elements; and
- .5 the rated flow capacity of the spring-loaded pressure relief devices, frangible discs or fusible elements in standard cubic metres of air per second (m<sup>3</sup>/s).
- .6 The cross sectional flow areas of the spring loaded pressure-relief devices, frangible discs and fusible elements in mm<sup>2</sup>

When practicable, the following information shall also be shown:

- .7 the manufacturer's name and relevant catalogue number.

6.7.2.13.2 The rated flow capacity marked on the spring-loaded pressure relief devices shall be determined according to ISO 4126 1:2004 and ISO 4126-7:2004.

**6.7.2.14 Connections to pressure relief devices**

6.7.2.14.1 Connections to pressure relief devices shall be of sufficient size to enable the required discharge to pass unrestricted to the safety device. No stop-valve shall be installed between the shell and the pressure relief devices except where duplicate devices are provided for maintenance or other reasons and the stop-valves serving the devices actually in use are locked open or the stop-valves are interlocked so that at least one of the duplicate devices is always in use. There shall be no obstruction in an opening leading to a vent or pressure relief device which might restrict or cut off the flow from the shell to that device. Vents or pipes from the pressure relief device outlets, when used, shall deliver the relieved vapour or liquid to the atmosphere in conditions of minimum back-pressure on the relieving devices.

**6.7.2.15 Siting of pressure relief devices**

6.7.2.15.1 Each pressure relief device inlet shall be situated on top of the shell in a position as near the longitudinal and transverse centre of the shell as reasonably practicable. All pressure relief device inlets shall, under maximum filling conditions, be situated in the vapour space of the shell and the devices shall be so arranged as to ensure the escaping vapour is discharged unrestrictedly. For flammable substances, the escaping vapour shall be directed away from the shell in such a manner that it cannot impinge upon the shell. Protective devices which deflect the flow of vapour are permissible provided the required relief-device capacity is not reduced.

## Part 6 – Construction and testing of packagings, IBCs, etc.

- 6.7.2.15.2 Arrangements shall be made to prevent access to the pressure relief devices by unauthorized persons and to protect the devices from damage caused by the portable tank overturning.
- 6.7.2.16 Gauging devices
- 6.7.2.16.1 Glass level-gauges and gauges made of other fragile material, which are in direct communication with the contents of the tank, shall not be used.
- 6.7.2.17 Portable tank supports, frameworks, lifting and tie-down attachments
- 6.7.2.17.1 Portable tanks shall be designed and constructed with a support structure to provide a secure base during transport. The forces specified in 6.7.2.2.12 and the safety factor specified in 6.7.2.2.13 shall be considered in this aspect of the design. Skids, frameworks, cradles or other similar structures are acceptable.
- 6.7.2.17.2 The combined stresses caused by portable tank mountings (such as cradles, framework, etc.) and portable tank lifting and tie-down attachments shall not cause excessive stress in any portion of the shell. Permanent lifting and tie-down attachments shall be fitted to all portable tanks. Preferably they shall be fitted to the portable tank supports but may be secured to reinforcing plates located on the shell at the points of support.
- 6.7.2.17.3 In the design of supports and frameworks, the effects of environmental corrosion shall be taken into account.
- 6.7.2.17.4 Forklift pockets shall be capable of being closed off. The means of closing forklift pockets shall be a permanent part of the framework or permanently attached to the framework. Single-compartment portable tanks with a length less than 3.65 m need not have closed-off forklift pockets provided that:
- .1 the shell, including all the fittings, is well protected from being hit by the forklift blades; and
  - .2 the distance between the centres of the forklift pockets is at least half of the maximum length of the portable tank.
- 6.7.2.17.5 When portable tanks are not protected during transport, according to 4.2.1.2, the shells and service equipment shall be protected against damage to the shell and service equipment resulting from lateral or longitudinal impact or overturning. External fittings shall be protected so as to preclude the release of the shell contents upon impact or overturning of the portable tank on its fittings. Examples of protection include:
- .1 protection against lateral impact, which may consist of longitudinal bars protecting the shell on both sides at the level of the median line;
  - .2 protection of the portable tank against overturning, which may consist of reinforcement rings or bars fixed across the frame;
  - .3 protection against rear impact, which may consist of a bumper or frame;
  - .4 protection of the shell against damage from impact or overturning by use of an ISO frame in accordance with ISO 1496-3:1995.
- 6.7.2.18 Design approval
- 6.7.2.18.1 The competent authority or its authorized body shall issue a design approval certificate for any new design of a portable tank. This certificate shall attest that a portable tank has been surveyed by that authority, is suitable for its intended purpose and meets the provisions of this chapter and, where appropriate, the provisions for substances provided in chapter 4.2 and in the Dangerous Goods List in chapter 3.2. When a series of portable tanks are manufactured without change in the design, the certificate shall be valid for the entire series. The certificate shall refer to the prototype test report, the substances or group of substances allowed to be transported, the materials of construction of the shell and lining (when applicable) and an approval number. The approval number shall consist of the distinguishing sign or mark of the State in whose territory the approval was granted, i.e., the distinguishing sign for use in international traffic as prescribed by the Convention on Road Traffic, Vienna, 1968, and a registration number. Any alternative arrangements according to 6.7.1.2 shall be indicated on the certificate. A design approval may serve for the approval of smaller portable tanks made of materials of the same kind and thickness, by the same fabrication techniques and with identical supports, equivalent closures and other appurtenances.
- 6.7.2.18.2 The prototype test report for the design approval shall include at least the following:
- .1 the results of the applicable framework test specified in ISO 1496-3:1995;
  - .2 the results of the initial inspection and test in 6.7.2.19.3; and
  - .3 the results of the impact test in 6.7.2.19.1, when applicable.
- 6.7.2.19 Inspection and testing
- 6.7.2.19.1 Portable tanks meeting the definition of *container* in the International Convention for Safe Containers (CSC), 1972, as amended, shall not be used unless they are successfully qualified by subjecting a representative

**Chapter 6.7 – Design, construction, inspection and testing of portable tanks & MEGCs**

prototype of each design to the Dynamic, Longitudinal Impact Test prescribed in the United Nations *Manual of Tests and Criteria*, part IV, section 41. This provision only applies to portable tanks which are constructed according to a design approval certificate which has been issued on or after 1 January 2008.

- 6.7.2.19.2** The shell and items of equipment of each portable tank shall be inspected and tested before being put into service for the first time (initial inspection and test) and thereafter at not more than five-year intervals (5-year periodic inspection and test) with an intermediate periodic inspection and test (2.5-year periodic inspection and test) midway between the 5-year periodic inspections and tests. The 2.5-year periodic inspection and test may be performed within 3 months of the specified date. An exceptional inspection and test shall be performed regardless of the date of the last periodic inspection and test when necessary according to 6.7.2.19.7.
- 6.7.2.19.3** The initial inspection and test of a portable tank shall include a check of the design characteristics, an internal and external examination of the portable tank and its fittings with due regard to the substances to be transported, and a pressure test. Before the portable tank is placed into service, a leakproofness test and a test of the satisfactory operation of all service equipment shall also be performed. When the shell and its fittings have been pressure-tested separately, they shall be subjected together after assembly to a leakproofness test.
- 6.7.2.19.4** The 5-year periodic inspection and test shall include an internal and external examination and, as a general rule, a hydraulic pressure test. For tanks only used for the transport of solid substances other than toxic or corrosive substances, which do not liquefy during transport, the hydraulic pressure test may be replaced by a suitable pressure test at 1.5 times MAWP, subject to competent authority approval. Sheathing, thermal insulation and the like shall be removed only to the extent required for reliable appraisal of the condition of the portable tank. When the shell and equipment have been pressure-tested separately, they shall be subjected together after assembly to a leakproofness test.
- 6.7.2.19.4.1** The heating system shall be subject to inspection and tests including pressure tests on heating coils or ducts during the 5-year periodic inspection.
- 6.7.2.19.5** The intermediate 2.5-year periodic inspection and test shall at least include an internal and external examination of the portable tank and its fittings with due regard to the substances intended to be transported, a leakproofness test and a test of the satisfactory operation of all service equipment. Sheathing, thermal insulation and the like shall be removed only to the extent required for reliable appraisal of the condition of the portable tank. For portable tanks dedicated to the transport of a single substance, the 2.5-year internal examination may be waived or substituted by other test methods or inspection procedures specified by the competent authority or its authorized body.
- 6.7.2.19.6** A portable tank may not be filled and offered for transport after the date of expiry of the last 5-year or 2.5-year periodic inspection and test as required by 6.7.2.19.2. However, a portable tank filled prior to the date of expiry of the last periodic inspection and test may be transported for a period not to exceed three months beyond the date of expiry of the last periodic test or inspection. In addition, a portable tank may be transported after the date of expiry of the last periodic test and inspection:
- .1 after emptying but before cleaning, for purposes of performing the next required test or inspection prior to refilling; and
  - .2 unless otherwise approved by the competent authority, for a period not to exceed six months beyond the date of expiry of the last periodic test or inspection, in order to allow the return of dangerous goods for proper disposal or recycling. Reference to this exemption shall be mentioned in the transport document.
- 6.7.2.19.7** The exceptional inspection and test is necessary when the portable tank shows evidence of damaged or corroded areas, or leakage, or other conditions that indicate a deficiency that could affect the integrity of the portable tank. The extent of the exceptional inspection and test shall depend on the amount of damage or deterioration of the portable tank. It shall include at least the 2.5-year periodic inspection and test according to 6.7.2.19.5.
- 6.7.2.19.8** The internal and external examinations shall ensure that:
- .1 the shell is inspected for pitting, corrosion, or abrasions, dents, distortions, defects in welds or any other conditions, including leakage, that might render the portable tank unsafe for transport;
  - .2 the piping, valves, heating/cooling system, and gaskets are inspected for corroded areas, defects, or any other conditions, including leakage, that might render the portable tank unsafe for filling, discharge or transport;
  - .3 devices for tightening manhole covers are operative and there is no leakage at manhole covers or gaskets;
  - .4 missing or loose bolts or nuts on any flanged connection or blank flange are replaced or tightened;
  - .5 all emergency devices and valves are free from corrosion, distortion and any damage or defect that could prevent their normal operation. Remote closure devices and self-closing stop-valves shall be operated to demonstrate proper operation;

Part 6 – Construction and testing of packagings, IBCs, etc.

- .6 linings, if any, are inspected in accordance with criteria outlined by the lining manufacturer;
- .7 required markings on the portable tank are legible and in accordance with the applicable provisions; and
- .8 the framework, supports and arrangements for lifting the portable tank are in a satisfactory condition.

6.7.2.19.9 The inspections and tests in 6.7.2.19.1, 6.7.2.19.3, 6.7.2.19.4, 6.7.2.19.5 and 6.7.2.19.7 shall be performed or witnessed by an expert approved by the competent authority or its authorized body. When the pressure test is a part of the inspection and test, the test pressure shall be the one indicated on the data plate of the portable tank. While under pressure, the portable tank shall be inspected for any leaks in the shell, piping or equipment.

6.7.2.19.10 In all cases when cutting, burning or welding operations on the shell have been effected, that work shall be to the approval of the competent authority or its authorized body, taking into account the pressure-vessel code used for the construction of the shell. A pressure test to the original test pressure shall be performed after the work is completed.

6.7.2.19.11 When evidence of any unsafe condition is discovered, the portable tank shall not be returned to service until it has been corrected and the test is repeated and passed.

6.7.2.20 Marking

6.7.2.20.1 Every portable tank shall be fitted with a corrosion-resistant metal plate permanently attached to the portable tank in a conspicuous place readily accessible for inspection. When for reasons of portable tank arrangements the plate cannot be permanently attached to the shell, the shell shall be marked with at least the information required by the pressure-vessel code. As a minimum, at least the following information shall be marked on the plate by stamping or by any other similar method:

- (a) Owner information
  - (i) Owner's registration number;
- (b) Manufacturing information
  - (i) Country of manufacture;
  - (ii) Year of manufacture;
  - (iii) Manufacturer's name or mark;
  - (iv) Manufacturer's serial number;
- (c) Approval information
  - (i) The United Nations packaging symbol



This symbol shall not be used for any purpose other than certifying that a packaging, a flexible bulk container, a portable tank or a MEGC complies with the relevant requirements in Chapter 6.1, 6.2, 6.3, 6.5, 6.6, 6.7 or 6.9;

- (ii) Approval country;
- (iii) Authorized body for the design approval;
- (iv) Design approval number;
- (v) Letters "AA", if the design was approved under alternative arrangements (see 6.7.1.2);
- (vi) Pressure-vessel code to which the shell is designed;
- (d) Pressures
  - (i) MAWP (in bar gauge or kPa gauge);\*
  - (ii) Test pressure (in bar gauge or kPa gauge);\*
  - (iii) Initial pressure test date (month and year);
  - (iv) Identification mark of the initial pressure test witness;
  - (v) External design pressure<sup>†</sup> (in bar gauge or kPa gauge);\*
  - (vi) MAWP for heating/cooling system (in bar gauge or kPa gauge)\* (when applicable);
- (e) Temperatures
  - (i) Design temperature range (in °C);\*
- (f) Materials
  - (i) Shell material(s) and material standard reference(s);
  - (ii) Equivalent thickness in reference steel (in mm);\* and
  - (iii) Lining material (when applicable);

\* The unit used shall be indicated.

† See 6.7.2.2.10.

**Chapter 6.7 – Design, construction, inspection and testing of portable tanks & MEGCs**

- (g) Capacity
- (i) Tank water capacity at 20°C (in litres);\*
- This indication is to be followed by the symbol “S” when the shell is divided by surge plates into sections of not more than 7,500 litres capacity;
- (ii) Water capacity of each compartment at 20°C (in litres)\* (when applicable, for multi-compartment tanks).
- This indication is to be followed by the symbol “S” when the compartment is divided by surge plates into sections of not more than 7,500 litres capacity;
- (h) Periodic inspections and tests
- (i) Type of the most recent periodic test (2.5-year, 5-year or exceptional);
- (ii) Date of the most recent periodic test (month and year);
- (iii) Test pressure (in bar gauge or kPa gauge)\* of the most recent periodic test (if applicable);
- (iv) Identification mark of the authorized body who performed or witnessed the most recent test.

**Figure 6.7.2.20.1 – Example of identification plate marking**

Owner's registration number			
<b>MANUFACTURING INFORMATION</b>			
Country of manufacture			
Year of manufacture			
Manufacturer			
Manufacturer's serial number			
<b>APPROVAL INFORMATION</b>			
	Approval country		
	Authorized body for design approval		
	Design approval number		“AA” (if applicable)
Shell design code (pressure-vessel code)			
<b>PRESSURES</b>			
MAWP			bar or kPa
Test pressure			bar or kPa
Initial pressure test date:	(mm/yyyy)	Witness stamp:	
External design pressure			bar or kPa
MAWP for heating/cooling system (when applicable)			bar or kPa
<b>TEMPERATURES</b>			
Design temperature range			°C to °C
<b>MATERIALS</b>			
Shell material(s) and material standard reference(s)			
Equivalent thickness in reference steel			mm
Lining material (when applicable)			
<b>CAPACITY</b>			
Tank water capacity at 20°C			litres “S” (if applicable)
Water capacity of compartment ___ at 20°C (when applicable, for multi-compartment tanks)			litres “S” (if applicable)

\* The unit used shall be indicated.

Part 6 – Construction and testing of packagings, IBCs, etc.

PERIODIC INSPECTIONS/TESTS							
Test type	Test date	Witness stamp and test pressure <sup>a</sup>		Test type	Test date	Witness stamp and test pressure <sup>a</sup>	
	(mm/yyyy)		bar or kPa		(mm/yyyy)		bar or kPa

<sup>a</sup> Test pressure if applicable.

6.7.2.20.2 The following information shall be marked either on the portable tank itself or on a metal plate firmly secured to the portable tank:

- Name of the operator
- Maximum permissible gross mass (MPGM) . . . . . kg
- Unladen (tare) mass . . . . . kg
- Portable tank instruction in accordance with 4.2.5.2.6.

6.7.2.20.3 If a portable tank is designed and approved for handling in open seas, the words "OFFSHORE PORTABLE TANK" shall be marked on the identification plate.

**6.7.3 Provisions for the design, construction, inspection and testing of portable tanks intended for the transport of non-refrigerated liquefied gases of class 2**

**Note:** These requirements also apply to portable tanks intended for the transport of chemicals under pressure (UN Nos. 3500, 3501, 3502, 3503, 3504 and 3505).

**6.7.3.1 Definitions**

For the purposes of this section:

*Design pressure* means the pressure to be used in calculations required by a recognized pressure-vessel code. The design pressure shall be not less than the highest of the following pressures:

- .1 the maximum effective gauge pressure allowed in the shell during filling or discharge; or
- .2 the sum of:
  - .1 the maximum effective gauge pressure to which the shell is designed, as defined in .2 of the MAWP definition (see below); and
  - .2 a head pressure determined on the basis of the static forces specified in 6.7.3.2.9, but not less than 0.35 bar;

*Design reference temperature* means the temperature at which the vapour pressure of the contents is determined for the purpose of calculating the MAWP. The design reference temperature shall be less than the critical temperature of the non-refrigerated liquefied gas or liquefied gas propellants of chemicals under pressure intended to be transported to ensure that the gas at all times is liquefied. This value for each portable tank type is as follows:

- .1 shell with a diameter of 1.5 m or less: 65°C;
- .2 shell with a diameter of more than 1.5 m:
  - .1 without insulation or sunshield: 60°C;
  - .2 with sunshield (see 6.7.3.2.12): 55°C; and
  - .3 with insulation (see 6.7.3.2.12): 50°C;

*Design temperature range* for the shell shall be –40°C to 50°C for non-refrigerated liquefied gases transported under ambient conditions. More severe design temperatures shall be considered for portable tanks subjected to severe climatic conditions;

*Filling density* means the average mass of non-refrigerated liquefied gas per litre of shell capacity (kg/ℓ). The filling density is given in portable tank instruction T50 in 4.2.5.2.6;

*Leakproofness test* means a test using gas subjecting the shell and its service equipment to an effective internal pressure of not less than 25% of the MAWP;

*Maximum allowable working pressure (MAWP)* means a pressure that shall be not less than the highest of the following pressures measured at the top of the shell while in operating position, but in no case less than 7 bar:

- .1 the maximum effective gauge pressure allowed in the shell during filling or discharge; or
- .2 the maximum effective gauge pressure to which the shell is designed, which shall be:
  - .1 for a non-refrigerated liquefied gas listed in the portable tank instruction T50 in 4.2.5.2.6, the MAWP (in bar) given in portable tank instruction T50 for that gas;
  - .2 for other non-refrigerated liquefied gases, not less than the sum of:
    - the absolute vapour pressure (in bar) of the non-refrigerated liquefied gas at the design reference temperature minus 1 bar; and
    - the partial pressure (in bar) of air or other gases in the ullage space, being determined by the design reference temperature and the liquid phase expansion due to an increase of the mean bulk temperature of  $t_r - t_f$  ( $t_f$  = filling temperature, usually 15°C;  $t_r$  = 50°C, maximum mean bulk temperature);
- .3 for chemicals under pressure, the MAWP (in bar) given in T50 portable tank instruction for the liquefied gas portion of the propellants listed in T50 in 4.2.5.2.6;

*Maximum permissible gross mass (MPGM)* means the sum of the tare mass of the portable tank and the heaviest load authorized for transport;

*Mild steel* means a steel with a guaranteed minimum tensile strength of 360 N/mm<sup>2</sup> to 440 N/mm<sup>2</sup> and a guaranteed minimum elongation at fracture conforming to 6.7.3.3.3.3;

*Portable tank* means a multimodal tank having a capacity of more than 450 ℓ used for the transport of non-refrigerated liquefied gases of class 2. The portable tank includes a shell fitted with service equipment and structural equipment necessary for the transport of gases. The portable tank shall be capable of being filled and discharged without the removal of its structural equipment. It shall possess stabilizing members external to the shell, and shall be capable of being lifted when full. It shall be designed primarily to be loaded onto a transport vehicle or ship and shall be equipped with skids, mountings or accessories to facilitate mechanical handling. Road tank-vehicles, rail tank-wagons, non-metallic tanks, intermediate bulk containers (IBCs), gas cylinders and large receptacles are not considered to fall within the definition for portable tanks;

*Reference steel* means a steel with a tensile strength of 370 N/mm<sup>2</sup> and an elongation at fracture of 27%;

*Service equipment* means measuring instruments and filling, discharge, venting, safety and insulating devices;

*Shell* means the part of the portable tank which retains the non-refrigerated liquefied gas intended for transport (tank proper), including openings and their closures, but does not include service equipment or external structural equipment;

*Structural equipment* means reinforcing, fastening, protective and stabilizing members external to the shell;

*Test pressure* means the maximum gauge pressure at the top of the shell during the pressure test.

### 6.7.3.2 General design and construction provisions

6.7.3.2.1 Shells shall be designed and constructed in accordance with the provisions of a pressure-vessel code recognized by the competent authority. Shells shall be made of steel suitable for forming. The materials shall, in principle, conform to national or international material standards. For welded shells, only a material whose weldability has been fully demonstrated shall be used. Welds shall be skilfully made and afford complete safety. When the manufacturing process or the materials make it necessary, the shells shall be suitably heat-treated to guarantee adequate toughness in the weld and in the heat-affected zones. In choosing the material, the design temperature range shall be taken into account with respect to risk of brittle fracture, to stress corrosion cracking and to resistance to impact. When fine-grain steel is used, the guaranteed value of the yield strength shall be not more than 460 N/mm<sup>2</sup> and the guaranteed value of the upper limit of the tensile strength shall be not more than 725 N/mm<sup>2</sup>, according to the material specification. Portable tank materials shall be suitable for the external environment in which they may be transported.

6.7.3.2.2 Portable tank shells, fittings and pipework shall be constructed of materials which are:

- .1 substantially immune to attack by the non-refrigerated liquefied gas(es) intended to be transported; or
- .2 properly passivated or neutralized by chemical reaction.

6.7.3.2.3 Gaskets shall be made of materials compatible with the non-refrigerated liquefied gas(es) intended to be transported.

6.7.3.2.4 Contact between dissimilar metals which could result in damage by galvanic action shall be avoided.

6.7.3.2.5 The materials of the portable tank, including any devices, gaskets, and accessories, shall not adversely affect the non-refrigerated liquefied gas(es) intended for transport in the portable tank.

## Part 6 – Construction and testing of packagings, IBCs, etc.

- 6.7.3.2.6 Portable tanks shall be designed and constructed with supports to provide a secure base during transport and with suitable lifting and tie-down attachments.
- 6.7.3.2.7 Portable tanks shall be designed to withstand, without loss of contents, at least the internal pressure due to the contents and the static, dynamic and thermal loads during normal conditions of handling and transport. The design shall demonstrate that the effects of fatigue, caused by repeated application of these loads through the expected life of the portable tank, have been taken into account.
- 6.7.3.2.7.1 For portable tanks that are intended for use as offshore tank-containers, the dynamic stresses imposed by handling in open seas shall be taken into account.
- 6.7.3.2.8 Shells shall be designed to withstand an external pressure of at least 0.4 bar gauge above the internal pressure without permanent deformation. When the shell is to be subjected to a significant vacuum before filling or during discharge, it shall be designed to withstand an external pressure of at least 0.9 bar gauge above the internal pressure and shall be proven at that pressure.
- 6.7.3.2.9 Portable tanks and their fastenings shall, under the maximum permissible load, be capable of absorbing the following separately applied static forces:
- .1 in the direction of travel: twice the MPGM multiplied by the acceleration due to gravity ( $g$ );\*
  - .2 horizontally at right angles to the direction of travel: the MPGM (when the direction of travel is not clearly determined, the forces shall be equal to twice the MPGM) multiplied by the acceleration due to gravity ( $g$ );\*
  - .3 vertically upwards: the MPGM multiplied by the acceleration due to gravity ( $g$ );\* and
  - .4 vertically downwards: twice the MPGM (total loading including the effect of gravity) multiplied by the acceleration due to gravity ( $g$ );\*
- 6.7.3.2.10 Under each of the forces in 6.7.3.2.9, the safety factor to be observed shall be as follows:
- .1 for steels having a clearly defined yield point, a safety factor of 1.5 in relation to the guaranteed yield strength; or
  - .2 for steels with no clearly defined yield point, a safety factor of 1.5 in relation to the guaranteed 0.2% proof strength and, for austenitic steels, the 1% proof strength.
- 6.7.3.2.11 The values of yield strength or proof strength shall be the values according to national or international material standards. When austenitic steels are used, the specified minimum values of yield strength and proof strength according to the material standards may be increased by up to 15% when these greater values are attested in the material inspection certificate. When no material standard exists for the steel in question, the value of yield strength or proof strength used shall be approved by the competent authority.
- 6.7.3.2.12 When the shells intended for the transport of non-refrigerated liquefied gases are equipped with thermal insulation, the thermal insulation system shall satisfy the following provisions:
- .1 It shall consist of a shield covering not less than the upper third but not more than the upper half of the surface of the shell and separated from the shell by an air space about 40 mm across; or
  - .2 It shall consist of a complete cladding of adequate thickness of insulating materials, protected so as to prevent the ingress of moisture and damage under normal conditions of transport and so as to provide a thermal conductance of not more than 0.67 W/m·K;
  - .3 When the protective covering is so closed as to be gas-tight, a device shall be provided to prevent any dangerous pressure from developing in the insulating layer in the event of inadequate gas-tightness of the shell or of its items of equipment;
  - .4 The thermal insulation shall not inhibit access to the fittings and discharge devices.
- 6.7.3.2.13 Portable tanks intended for the transport of flammable non-refrigerated liquefied gases shall be capable of being electrically earthed.
- 6.7.3.3 Design criteria**
- 6.7.3.3.1 Shells shall be of a circular cross-section.
- 6.7.3.3.2 Shells shall be designed and constructed to withstand a test pressure not less than 1.3 times the design pressure. The shell design shall take into account the minimum MAWP values provided in portable tank instruction T50 in 4.2.5.2.6 for each non-refrigerated liquefied gas intended for transport. Attention is drawn to the minimum shell thickness provisions for these shells specified in 6.7.3.4.
- 6.7.3.3.3 For steels exhibiting a clearly defined yield point or characterized by a guaranteed proof strength (0.2% proof strength, generally, or 1% proof strength for austenitic steels), the primary membrane stress  $\sigma$  (sigma) in the shell shall not exceed  $0.75R_e$  or  $0.50R_m$ , whichever is lower, at the test pressure, where:

\* For calculation purposes,  $g = 9.81 \text{ m/s}^2$ .



$R_e$  = yield strength in N/mm<sup>2</sup>, or 0.2% proof strength or, for austenitic steels, 1% proof strength.

$R_m$  = minimum tensile strength in N/mm<sup>2</sup>.

- 6.7.3.3.3.1 The values of  $R_e$  and  $R_m$  to be used shall be the specified minimum values according to national or international material standards. When austenitic steels are used, these specified minimum values for  $R_e$  and  $R_m$  according to the material standards may be increased by up to 15% when these greater values are attested in the material inspection certificate. When no material standard exists for the steel in question, the values of  $R_e$  and  $R_m$  used shall be approved by the competent authority or its authorized body.
- 6.7.3.3.3.2 Steels which have a  $R_e/R_m$  ratio of more than 0.85 are not allowed for the construction of welded shells. The values of  $R_e$  and  $R_m$  to be used in determining this ratio shall be the values specified in the material inspection certificate.
- 6.7.3.3.3.3 Steels used in the construction of shells shall have an elongation at fracture, in %, of not less than  $10,000/R_m$  with an absolute minimum of 16% for fine-grain steels and 20% for other steels.
- 6.7.3.3.3.4 For the purpose of determining actual values for materials, it shall be noted that for sheet metal, the axis of the tensile test specimen shall be at right angles (transversely) to the direction of rolling. The permanent elongation at fracture shall be measured on test specimens of rectangular cross-section in accordance with ISO 6892:1998 using a 50 mm gauge length.

#### 6.7.3.4 Minimum shell thickness

6.7.3.4.1 The minimum shell thickness shall be the greater thickness based on:

- .1 the minimum thickness determined in accordance with the provisions in 6.7.3.4; and
- .2 the minimum thickness determined in accordance with the recognized pressure-vessel code, including the provisions in 6.7.3.3.

6.7.3.4.2 The cylindrical portions, ends (heads) and manhole covers of shells of not more than 1.80 m in diameter shall be not less than 5 mm thick in the reference steel or of equivalent thickness in the steel to be used. Shells of more than 1.80 m in diameter shall be not less than 6 mm thick in the reference steel or of equivalent thickness in the steel to be used.

6.7.3.4.3 The cylindrical portions, ends (heads) and manhole covers of all shells shall be not less than 4 mm thick regardless of the material of construction.

6.7.3.4.4 The equivalent thickness of a steel other than the thickness prescribed for the reference steel in 6.7.3.4.2 shall be determined using the following formula:

$$e_1 = \frac{21.4 \times e_0}{\sqrt[3]{R_{m1} \times A_1}}$$

where:

$e_1$  = required equivalent thickness (in mm) of the steel to be used;

$e_0$  = minimum thickness (in mm) of the reference steel specified in 6.7.3.4.2;

$R_{m1}$  = guaranteed minimum tensile strength (in N/mm<sup>2</sup>) of the steel to be used (see 6.7.3.3.3);

$A_1$  = guaranteed minimum elongation at fracture (in %) of the steel to be used according to national or international standards.

6.7.3.4.5 In no case shall the wall thickness be less than that prescribed in 6.7.3.4.1 to 6.7.3.4.3. All parts of the shell shall have a minimum thickness as determined by 6.7.3.4.1 to 6.7.3.4.3. This thickness shall be exclusive of any corrosion allowance.

6.7.3.4.6 When mild steel is used (see 6.7.3.1), calculation using the equation in 6.7.3.4.4 is not required.

6.7.3.4.7 There shall be no sudden change of plate thickness at the attachment of the ends (heads) to the cylindrical portion of the shell.

#### 6.7.3.5 Service equipment

6.7.3.5.1 Service equipment shall be so arranged as to be protected against the risk of being wrenched off or damaged during handling and transport. When the connection between the frame and the shell allows relative movement between the sub-assemblies, the equipment shall be so fastened as to permit such movement without risk of damage to working parts. The external discharge fittings (pipe sockets, shut-off devices), the internal stop-valve and its seating shall be protected against the danger of being wrenched off by external forces (for example, by using shear sections). The filling and discharge devices (including flanges or threaded plugs) and any protective caps shall be capable of being secured against unintended opening.

## Part 6 – Construction and testing of packagings, IBCs, etc.

- 6.7.3.5.1.1 For offshore tank-containers, where positioning of service equipment and the design and strength of protection for such equipment is concerned, the increased danger of impact damage when handling such tanks in open seas shall be taken into account.
- 6.7.3.5.2 All openings with a diameter of more than 1.5 mm in shells of portable tanks, except openings for pressure relief devices, inspection openings and closed bleed holes, shall be fitted with at least three mutually independent shut-off devices in series, the first being an internal stop-valve, excess flow valve or equivalent device, the second being an external stop-valve and the third being a blank flange or equivalent device.
- 6.7.3.5.2.1 When a portable tank is fitted with an excess flow valve, the excess flow valve shall be so fitted that its seating is inside the shell or inside a welded flange or, when fitted externally, its mountings shall be designed so that, in the event of impact, its effectiveness shall be maintained. The excess flow valves shall be selected and fitted so as to close automatically when the rated flow specified by the manufacturer is reached. Connections and accessories leading to or from such a valve shall have a capacity for a flow more than the rated flow of the excess flow valve.
- 6.7.3.5.3 For filling and discharge openings, the first shut-off device shall be an internal stop-valve and the second shall be a stop-valve placed in an accessible position on each discharge and filling pipe.
- 6.7.3.5.4 For filling and discharge bottom openings of portable tanks intended for the transport of flammable and/or toxic non-refrigerated liquefied gases or chemicals under pressure, the internal stop-valve shall be a quick-closing safety device which closes automatically in the event of unintended movement of the portable tank during filling or discharge or fire engulfment. Except for portable tanks having a capacity of not more than 1000 ℓ, it shall be possible to operate this device by remote control.
- 6.7.3.5.5 In addition to filling, discharge and gas pressure equalizing orifices, shells may have openings in which gauges, thermometers and manometers can be fitted. Connections for such instruments shall be made by suitable welded nozzles or pockets and not be screwed connections through the shell.
- 6.7.3.5.6 All portable tanks shall be fitted with manholes or other inspection openings of suitable size to allow for internal inspection and adequate access for maintenance and repair of the interior.
- 6.7.3.5.7 External fittings shall be grouped together so far as reasonably practicable.
- 6.7.3.5.8 Each connection on a portable tank shall be clearly marked to indicate its function.
- 6.7.3.5.9 Each stop-valve or other means of closure shall be designed and constructed to a rated pressure not less than the MAWP of the shell, taking into account the temperatures expected during transport. All stop-valves with a screwed spindle shall close by a clockwise motion of the handwheel. For other stop-valves, the position (open and closed) and direction of closure shall be clearly indicated. All stop-valves shall be designed to prevent unintentional opening.
- 6.7.3.5.10 Piping shall be designed, constructed and installed so as to avoid the risk of damage due to thermal expansion and contraction, mechanical shock and vibration. All piping shall be of suitable metallic material. Welded pipe joints shall be used wherever possible.
- 6.7.3.5.11 Joints in copper tubing shall be brazed or have an equally strong metal union. The melting point of brazing materials shall be no lower than 525°C. The joints shall not decrease the strength of tubing, as may happen when cutting threads.
- 6.7.3.5.12 The burst pressure of all piping and pipe fittings shall be not less than the highest of four times the MAWP of the shell or four times the pressure to which it may be subjected in service by the action of a pump or other device (except pressure relief devices).
- 6.7.3.5.13 Ductile metals shall be used in the construction of valves and accessories.
- 6.7.3.6 Bottom openings**
- 6.7.3.6.1 Certain non-refrigerated liquefied gases shall not be transported in portable tanks with bottom openings when portable tank instruction T50 in 4.2.5.2.6 indicates that bottom openings are not allowed. There shall be no openings below the liquid level of the shell when it is filled to its maximum permissible filling limit.
- 6.7.3.7 Pressure relief devices**
- 6.7.3.7.1 Portable tanks shall be provided with one or more spring-loaded pressure relief devices. The pressure relief devices shall open automatically at a pressure not less than the MAWP and be fully open at a pressure equal to 110% of the MAWP. These devices shall, after discharge, close at a pressure not lower than 10% below the pressure at which discharge starts and shall remain closed at all lower pressures. The pressure relief devices shall be of a type that will resist dynamic forces, including liquid surge. Frangible discs not in series with a spring-loaded pressure relief device are not permitted.

*Chapter 6.7 – Design, construction, inspection and testing of portable tanks & MEGCs*

- 6.7.3.7.2** Pressure relief devices shall be designed to prevent the entry of foreign matter, the leakage of gas and the development of any dangerous excess pressure.
- 6.7.3.7.3** Portable tanks intended for the transport of certain non-refrigerated liquefied gases identified in portable tank instruction T50 in 4.2.5.2.6 shall have a pressure relief device approved by the competent authority. Unless a portable tank in dedicated service is fitted with an approved relief device constructed of materials compatible with the load, such device shall comprise a frangible disc preceding a spring-loaded device. The space between the frangible disc and the device shall be provided with a pressure gauge or a suitable tell-tale indicator. This arrangement permits the detection of disc rupture, pinholing or leakage which could cause a malfunction of the pressure relief device. The frangible discs shall rupture at a nominal pressure 10% above the start-to-discharge pressure of the relief device.
- 6.7.3.7.4** In the case of multi-purpose portable tanks, the pressure relief devices shall open at a pressure indicated in 6.7.3.7.1 for the gas having the highest maximum allowable pressure of the gases allowed to be transported in the portable tank.

**6.7.3.8 Capacity of relief devices**

- 6.7.3.8.1** The combined delivery capacity of the relief devices shall be sufficient that, in the event of total fire engulfment, the pressure (including accumulation) inside the shell does not exceed 120% of the MAWP. Spring-loaded relief devices shall be used to achieve the full relief capacity prescribed. In the case of multi-purpose tanks, the combined delivery capacity of the pressure relief devices shall be taken for the gas which requires the highest delivery capacity of the gases allowed to be transported in portable tanks.

- 6.7.3.8.1.1** To determine the total required capacity of the relief devices, which shall be regarded as being the sum of the individual capacities of the several devices, the following formula<sup>\*</sup> shall be used:

$$Q = 12.4 \frac{FA^{0.82}}{LC} \sqrt{\frac{ZT}{M}}$$

where:

**Q** = minimum required rate of discharge in cubic metres of air per second (m<sup>3</sup>/s) at standard conditions: 1 bar and 0°C (273 K);

**F** = a coefficient with the following value:

for uninsulated shells,  $F = 1$

for insulated shells,  $F = U(649 - t)/13.6$  but in no case is less than 0.25

where:

**U** = thermal conductance of the insulation, in kW·m<sup>-2</sup>·K<sup>-1</sup>, at 38°C;

**t** = actual temperature of the non-refrigerated liquefied gas during filling (in °C) (when this temperature is unknown, let  $t = 15$ °C);

The value of **F** given above for insulated shells may be taken provided that the insulation is in conformance with 6.7.3.8.1.2;

**A** = total external surface area of shell in square metres;

**Z** = the gas compressibility factor in the accumulating condition (when this factor is unknown, let **Z** equal 1.0);

**T** = absolute temperature in kelvin (°C + 273) above the pressure relief devices in the accumulating condition;

**L** = the latent heat of vaporization of the liquid, in kJ/kg, in the accumulating condition;

**M** = molecular mass of the discharged gas;

**C** = a constant which is derived from one of the following formulae as a function of the ratio **k** of specific heats:

$$k = \frac{C_p}{C_v}$$

where:

**C<sub>p</sub>** = specific heat at constant pressure; and

**C<sub>v</sub>** = specific heat at constant volume.

<sup>\*</sup> This formula applies only to non-refrigerated liquefied gases which have critical temperatures well above the temperature at the accumulating condition. For gases which have critical temperatures near or below the temperature at the accumulating condition, the calculation of the pressure-relief device delivery capacity shall consider further thermodynamic properties of the gas (see, for example, CGA S-1.2-2003 "Pressure Relief Device Standards – Part 2 – Cargo and Portable Tanks for Compressed Gases").

When  $k > 1$ :

$$C = \sqrt[k]{k \left( \frac{2}{k+1} \right)^{\frac{k+1}{k-1}}}$$

When  $k = 1$  or  $k$  is unknown:

$$C = \frac{1}{\sqrt{e}} = 0.607$$

where  $e$  is the mathematical constant 2.7183.

$C$  may also be taken from the following table:

$k$	$C$	$k$	$C$	$k$	$C$
1.00	0.607	1.26	0.660	1.52	0.704
1.02	0.611	1.28	0.664	1.54	0.707
1.04	0.615	1.30	0.667	1.56	0.71
1.06	0.620	1.32	0.671	1.58	0.713
1.08	0.624	1.34	0.674	1.60	0.716
1.10	0.628	1.36	0.678	1.62	0.719
1.12	0.633	1.38	0.681	1.64	0.722
1.14	0.637	1.40	0.685	1.66	0.725
1.16	0.641	1.42	0.688	1.68	0.728
1.18	0.645	1.44	0.691	1.70	0.731
1.20	0.649	1.46	0.695	2.0	0.77
1.22	0.652	1.48	0.698	2.2	0.793
1.24	0.656	1.50	0.701		

**6.7.3.8.1.2** Insulation systems, used for the purpose of reducing the venting capacity, shall be approved by the competent authority or its authorized body. In all cases, insulation systems approved for this purpose shall:

- .1 remain effective at all temperatures up to 649°C; and
- .2 be jacketed with a material having a melting point of 700°C or greater.

**6.7.3.9 Marking of pressure relief devices**

**6.7.3.9.1** Every pressure relief device shall be clearly and permanently marked with the following:

- .1 the pressure (in bar or kPa) at which it is set to discharge;
- .2 the allowable tolerance at the discharge pressure, for spring-loaded devices;
- .3 the reference temperature corresponding to the rated pressure, for frangible discs; and
- .4 the rated flow capacity of the device in standard cubic metres of air per second (m<sup>3</sup>/s).
- .5 The cross sectional flow areas of the spring loaded pressure-relief devices and frangible discs in mm<sup>2</sup>

When practicable, the following information shall also be shown:

- .6 the manufacturer's name and relevant catalogue number.

**6.7.3.9.2** The rated flow capacity marked on the pressure relief devices shall be determined according to ISO 4126 1:2004 and ISO 4126-7:2004.

**6.7.3.10 Connections to pressure relief devices**

**6.7.3.10.1** Connections to pressure relief devices shall be of sufficient size to enable the required discharge to pass unrestricted to the safety device. No stop-valve shall be installed between the shell and the pressure relief devices except when duplicate devices are provided for maintenance or other reasons and the stop-valves serving the devices actually in use are locked open or the stop-valves are interlocked so that at least one of the duplicate devices is always operable and capable of meeting the provisions of 6.7.3.8. There shall be no obstruction in an opening leading to a vent or pressure relief device which might restrict or cut off the flow from the shell to that device. Vents from the pressure relief devices, when used, shall deliver the relieved vapour or liquid to the atmosphere in conditions of minimum back-pressure on the relieving device.

**6.7.3.11 Siting of pressure relief devices**

**6.7.3.11.1** Each pressure relief device inlet shall be situated on top of the shell in a position as near the longitudinal and transverse centre of the shell as reasonably practicable. All pressure relief device inlets shall, under maximum filling conditions, be situated in the vapour space of the shell and the devices shall be so arranged as to ensure that the escaping vapour is discharged unrestrictedly. For flammable non-refrigerated liquefied gases, the escaping vapour shall be directed away from the shell in such a manner that it cannot impinge upon the

shell. Protective devices which deflect the flow of vapour are permissible provided the required relief-device capacity is not reduced.

- 6.7.3.11.2** Arrangements shall be made to prevent access to the pressure relief devices by unauthorized persons and to protect the devices from damage caused by the portable tank overturning.
- 6.7.3.12 Gauging devices**
- 6.7.3.12.1** Unless a portable tank is intended to be filled by mass, it shall be equipped with one or more gauging devices. Glass level-gauges and gauges made of other fragile material, which are in direct communication with the contents of the shell, shall not be used.
- 6.7.3.13 Portable tank supports, frameworks, lifting and tie-down attachments**
- 6.7.3.13.1** Portable tanks shall be designed and constructed with a support structure to provide a secure base during transport. The forces specified in 6.7.3.2.9 and the safety factor specified in 6.7.3.2.10 shall be considered in this aspect of the design. Skids, frameworks, cradles or other similar structures are acceptable.
- 6.7.3.13.2** The combined stresses caused by portable tank mountings (such as cradles, frameworks, etc.) and portable tank lifting and tie-down attachments shall not cause excessive stress in any portion of the shell. Permanent lifting and tie-down attachments shall be fitted to all portable tanks. Preferably they shall be fitted to the portable tank supports but may be secured to reinforcing plates located on the shell at the points of support.
- 6.7.3.13.3** In the design of supports and frameworks, the effects of environmental corrosion shall be taken into account.
- 6.7.3.13.4** Forklift pockets shall be capable of being closed off. The means of closing forklift pockets shall be a permanent part of the framework or permanently attached to the framework. Single-compartment portable tanks with a length less than 3.65 m need not have closed-off forklift pockets provided that:
- .1 the shell and all the fittings are well protected from being hit by the forklift blades; and
  - .2 the distance between the centres of the forklift pockets is at least half of the maximum length of the portable tank.
- 6.7.3.13.5** When portable tanks are not protected during transport, according to 4.2.2.3, the shells and service equipment shall be protected against damage to the shell and service equipment resulting from lateral or longitudinal impact or overturning. External fittings shall be protected so as to preclude the release of the shell contents upon impact or overturning of the portable tank on its fittings. Examples of protection include:
- .1 protection against lateral impact, which may consist of longitudinal bars protecting the shell on both sides at the level of the median line;
  - .2 protection of the portable tank against overturning, which may consist of reinforcement rings or bars fixed across the frame;
  - .3 protection against rear impact, which may consist of a bumper or frame;
  - .4 protection of the shell against damage from impact or overturning by use of an ISO frame in accordance with ISO 1496-3:1995.
- 6.7.3.14 Design approval**
- 6.7.3.14.1** The competent authority or its authorized body shall issue a design approval certificate for any new design of a portable tank. This certificate shall attest that the portable tank has been surveyed by that authority, is suitable for its intended purpose and meets the provisions of this chapter and, when appropriate, the provisions for gases provided in portable tank instruction T50 in 4.2.5.2.6. When a series of portable tanks are manufactured without change in the design, the certificate shall be valid for the entire series. The certificate shall refer to the prototype test report, the gases allowed to be transported, the materials of construction of the shell and an approval number. The approval number shall consist of the distinguishing sign or mark of the State in whose territory the approval was granted, i.e., the distinguishing sign for use in international traffic, as prescribed by the Convention on Road Traffic, Vienna, 1968, and a registration number. Any alternative arrangements according to 6.7.1.2 shall be indicated on the certificate. A design approval may serve for the approval of smaller portable tanks made of materials of the same kind and thickness, by the same fabrication techniques and with identical supports, equivalent closures and other appurtenances.
- 6.7.3.14.2** The prototype test report for the design approval shall include at least the following:
- .1 the results of the applicable framework test specified in ISO 1496-3:1995;
  - .2 the results of the initial inspection and test in 6.7.3.15.3; and
  - .3 the results of the impact test in 6.7.3.15.1, when applicable.

## Part 6 – Construction and testing of packagings, IBCs, etc.

## 6.7.3.15 Inspection and testing

- 6.7.3.15.1 Portable tanks meeting the definition of *container* in the International Convention for Safe Containers (CSC), 1972, as amended, shall not be used unless they are successfully qualified by subjecting a representative prototype of each design to the Dynamic, Longitudinal Impact Test prescribed in the United Nations *Manual of Tests and Criteria*, part IV, section 41. This provision only applies to portable tanks which are constructed according to a design approval certificate which has been issued on or after 1 January 2008.
- 6.7.3.15.2 The shell and items of equipment of each portable tank shall be inspected and tested before being put into service for the first time (initial inspection and test) and thereafter at not more than five-year intervals (5-year periodic inspection and test) with an intermediate periodic inspection and test (2.5-year periodic inspection and test) midway between the 5-year periodic inspections and tests. The 2.5-year periodic inspection and test may be performed within 3 months of the specified date. An exceptional inspection and test shall be performed regardless of the last periodic inspection and test when necessary according to 6.7.3.15.7.
- 6.7.3.15.3 The initial inspection and test of a portable tank shall include a check of the design characteristics, an internal and external examination of the portable tank and its fittings with due regard to the non-refrigerated liquefied gases to be transported, and a pressure test referring to the test pressures according to 6.7.3.3.2. The pressure test may be performed as a hydraulic test or by using another liquid or gas with the agreement of the competent authority or its authorized body. Before the portable tank is placed into service, a leakproofness test and a test of the satisfactory operation of all service equipment shall also be performed. When the shell and its fittings have been pressure-tested separately, they shall be subjected together after assembly to a leakproofness test. All welds subject to full stress level in the shell shall be inspected during the initial test by radiographic, ultrasonic, or another suitable non-destructive test method. This does not apply to the jacket.
- 6.7.3.15.4 The 5-year periodic inspection and test shall include an internal and external examination and, as a general rule, a hydraulic pressure test. Sheathing, thermal insulation and the like shall be removed only to the extent required for reliable appraisal of the condition of the portable tank. When the shell and equipment have been pressure-tested separately, they shall be subjected together after assembly to a leakproofness test.
- 6.7.3.15.5 The intermediate 2.5-year periodic inspection and test shall at least include an internal and external examination of the portable tank and its fittings with due regard to the non-refrigerated liquefied gases intended to be transported, a leakproofness test and a test of the satisfactory operation of all service equipment. Sheathing, thermal insulation and the like shall be removed only to the extent required for reliable appraisal of the condition of the portable tank. For portable tanks intended for the transport of a single non-refrigerated liquefied gas, the 2.5-year internal examination may be waived or substituted by other test methods or inspection procedures specified by the competent authority or its authorized body.
- 6.7.3.15.6 A portable tank may not be filled and offered for transport after the date of expiry of the last 5-year or 2.5-year periodic inspection and test as required by 6.7.3.15.2. However, a portable tank filled prior to the date of expiry of the last periodic inspection and test may be transported for a period not to exceed three months beyond the date of expiry of the last periodic test or inspection. In addition, a portable tank may be transported after the date of expiry of the last periodic test and inspection:
- .1 after emptying but before cleaning, for purposes of performing the next required test or inspection prior to refilling; and
  - .2 unless otherwise approved by the competent authority, for a period not to exceed six months beyond the date of expiry of the last periodic test or inspection, in order to allow the return of dangerous goods for proper disposal or recycling. Reference to this exemption shall be mentioned in the transport document.
- 6.7.3.15.7 The exceptional inspection and test is necessary when the portable tank shows evidence of damaged or corroded areas, or leakage, or other conditions that indicate a deficiency that could affect the integrity of the portable tank. The extent of the exceptional inspection and test shall depend on the amount of damage or deterioration of the portable tank. It shall include at least the 2.5-year inspection and test according to 6.7.3.15.5.
- 6.7.3.15.8 The internal and external examinations shall ensure that:
- .1 the shell is inspected for pitting, corrosion, or abrasions, dents, distortions, defects in welds or any other conditions, including leakage, that might render the portable tank unsafe for transport;
  - .2 the piping, valves, and gaskets are inspected for corroded areas, defects, or any other conditions, including leakage, that might render the portable tank unsafe for filling, discharge or transport;
  - .3 devices for tightening manhole covers are operative and there is no leakage at manhole covers or gaskets;
  - .4 missing or loose bolts or nuts on any flanged connection or blank flange are replaced or tightened;
  - .5 all emergency devices and valves are free from corrosion, distortion and any damage or defect that could prevent their normal operation. Remote closure devices and self-closing stop-valves shall be operated to demonstrate proper operation;
  - .6 required markings on the portable tank are legible and in accordance with the applicable provisions; and

.7 the framework, the supports and the arrangements for lifting the portable tank are in satisfactory condition.

**6.7.3.15.9** The inspections and tests in 6.7.3.15.1, 6.7.3.15.3, 6.7.3.15.4, 6.7.3.15.5 and 6.7.3.15.7 shall be performed or witnessed by an expert approved by the competent authority or its authorized body. When the pressure test is a part of the inspection and test, the test pressure shall be the one indicated on the data plate of the portable tank. While under pressure, the portable tank shall be inspected for any leaks in the shell, piping or equipment.

**6.7.3.15.10** In all cases when cutting, burning or welding operations on the shell have been effected, that work shall be to the approval of the competent authority or its authorized body, taking into account the pressure-vessel code used for the construction of the shell. A pressure test to the original test pressure shall be performed after the work is completed.

**6.7.3.15.11** When evidence of any unsafe condition is discovered, the portable tank shall not be returned to service until it has been corrected and the pressure test is repeated and passed.

**6.7.3.16 Marking**

**6.7.3.16.1** Every portable tank shall be fitted with a corrosion-resistant metal plate permanently attached to the portable tank in a conspicuous place readily accessible for inspection. When for reasons of portable tank arrangements the plate cannot be permanently attached to the shell, the shell shall be marked with at least the information required by the pressure-vessel code. As a minimum, at least the following information shall be marked on the plate by stamping or by any other similar method:

- (a) Owner information
  - (i) Owner's registration number;
- (b) Manufacturing information
  - (i) Country of manufacture;
  - (ii) Year of manufacture;
  - (iii) Manufacturer's name or mark;
  - (iv) Manufacturer's serial number;
- (c) Approval information
  - (i) The United Nations packaging symbol



This symbol shall not be used for any purpose other than certifying that a packaging, a flexible bulk container, a portable tank or a MEGC complies with the relevant requirements in Chapter 6.1, 6.2, 6.3, 6.5, 6.6, 6.7 or 6.9;

- (ii) Approval country;
- (iii) Authorized body for the design approval;
- (iv) Design approval number;
- (v) Letters "AA", if the design was approved under alternative arrangements (see 6.7.1.2);
- (vi) Pressure-vessel code to which the shell is designed;
- (d) Pressures
  - (i) MAWP (in bar gauge or kPa gauge);\*
  - (ii) Test pressure (in bar gauge or kPa gauge);\*
  - (iii) Initial pressure test date (month and year);
  - (iv) Identification mark of the initial pressure test witness;
  - (v) External design pressure<sup>†</sup> (in bar gauge or kPa gauge);\*
- (e) Temperatures
  - (i) Design temperature range (in °C);\*
  - (ii) Design reference temperature (in °C);\*
- (f) Materials
  - (i) Shell material(s) and material standard reference(s);
  - (ii) Equivalent thickness in reference steel (in mm);\*
- (g) Capacity
  - (i) Tank water capacity at 20°C (in litres);\*
- (h) Periodic inspections and tests
  - (i) Type of the most recent periodic test (2.5-year, 5-year or exceptional);

\* The unit used shall be indicated.

<sup>†</sup> See 6.7.3.2.8.

**Part 6 – Construction and testing of packagings, IBCs, etc.**

- (ii) Date of the most recent periodic test (month and year);
- (iii) Test pressure (in bar gauge or kPa gauge)\* of the most recent periodic test (if applicable);
- (iv) Identification mark of the authorized body who performed or witnessed the most recent test.

**Figure 6.7.3.16.1 – Example of identification plate marking**

Owner's registration number							
<b>MANUFACTURING INFORMATION</b>							
Country of manufacture							
Year of manufacture							
Manufacturer							
Manufacturer's serial number							
<b>APPROVAL INFORMATION</b>							
	Approval country						
	Authorized body for design approval						
	Design approval number		“AA” (if applicable)				
Shell design code (pressure-vessel code)							
<b>PRESSURES</b>							
MAWP		bar or kPa					
Test pressure		bar or kPa					
Initial pressure test date:	(mm/yyyy)	Witness stamp:					
External design pressure		bar or kPa					
<b>TEMPERATURES</b>							
Design temperature range		°C to °C					
Design reference temperature		°C					
<b>MATERIALS</b>							
Shell material(s) and material standard reference(s)							
Equivalent thickness in reference steel		mm					
<b>CAPACITY</b>							
Tank water capacity at 20°C		litres					
<b>PERIODIC INSPECTIONS/TESTS</b>							
Test type	Test date	Witness stamp and test pressure <sup>a</sup>		Test type	Test date	Witness stamp and test pressure <sup>a</sup>	
	(mm/yyyy)		bar or kPa		(mm/yyyy)		bar or kPa

<sup>a</sup> Test pressure if applicable.

**6.7.3.16.2** The following information shall be durably marked either on the portable tank itself or on a metal plate firmly secured to the portable tank:

- Name of the operator
- Name of non-refrigerated liquefied gas(es) permitted for transport
- Maximum permissible load mass for each non-refrigerated liquefied gas permitted . . . . . kg
- Maximum permissible gross mass (MPGM) . . . . . kg
- Unladen (tare) mass . . . . . kg



Portable tank instruction in accordance with 4.2.5.2.6.

- 6.7.3.16.3 If a portable tank is designed and approved for handling in open seas, the words “OFFSHORE PORTABLE TANK” shall be marked on the identification plate.

## 6.7.4 Provisions for the design, construction, inspection and testing of portable tanks intended for the transport of refrigerated liquefied gases of class 2

### 6.7.4.1 Definitions

For the purposes of this section:

*Holding time* means the time that will elapse from the establishment of the initial filling condition until the pressure has risen due to heat influx to the lowest set pressure of the pressure-limiting device(s);

*Jacket* means the outer insulation cover or cladding, which may be part of the insulation system;

*Leakproofness test* means a test, using gas, subjecting the shell and its service equipment to an effective internal pressure not less than 90% of the MAWP;

*Maximum allowable working pressure (MAWP)* means the maximum effective gauge pressure permissible at the top of the shell of a filled portable tank in its operating position, including the highest effective pressure during filling and discharge;

*Maximum permissible gross mass (MPGM)* means the sum of the tare mass of the portable tank and the heaviest load authorized for transport;

*Minimum design temperature* means the temperature which is used for the design and construction of the shell, not higher than the lowest (coldest) temperature (service temperature) of the contents during normal conditions of filling, discharge and transport;

*Portable tank* means a thermally insulated multimodal tank having a capacity of more than 450 ℓ fitted with service equipment and structural equipment necessary for the transport of refrigerated liquefied gases. The portable tank shall be capable of being filled and discharged without the removal of its structural equipment. It shall possess stabilizing members external to the tank, and shall be capable of being lifted when full. It shall be designed primarily to be loaded onto a transport vehicle or ship and shall be equipped with skids, mountings or accessories to facilitate mechanical handling. Road tank-vehicles, rail tank-wagons, non-metallic tanks, intermediate bulk containers (IBCs), gas cylinders and large receptacles are not considered to fall within the definition for portable tanks;

*Reference steel* means a steel with a tensile strength of 370 N/mm<sup>2</sup> and an elongation at fracture of 27%;

*Service equipment* means measuring instruments and filling, discharge, venting, safety, pressurizing, cooling and thermal insulation devices;

*Shell* means the part of the portable tank which retains the refrigerated liquefied gas intended for transport, including openings and their closures, but does not include service equipment or external structural equipment;

*Structural equipment* means the reinforcing, fastening, protective and stabilizing members external to the shell;

*Tank* means a construction which normally consists of either:

- (a) a jacket and one or more inner shells where the space between the shell(s) and the jacket is exhausted of air (vacuum insulation) and may incorporate a thermal insulation system; or
- (b) a jacket and an inner shell with an intermediate layer of solid thermally insulating material (such as solid foam);

*Test pressure* means the maximum gauge pressure at the top of the shell during the pressure test.

### 6.7.4.2 General design and construction provisions

- 6.7.4.2.1 Shells shall be designed and constructed in accordance with the provisions of a pressure-vessel code recognized by the competent authority. Shells and jackets shall be made of metallic materials suitable for forming. Jackets shall be made of steel. Non-metallic materials may be used for the attachments and supports between the shell and jacket, provided their material properties at the minimum design temperature are proven to be sufficient. The materials shall, in principle, conform to national or international material standards. For welded shells and jackets, only materials whose weldability has been fully demonstrated shall be used. Welds shall be skilfully made and afford complete safety. When the manufacturing process or the materials make it necessary, the shell shall be suitably heat-treated to guarantee adequate toughness in the weld and in the heat-affected zones. In choosing the material, the minimum design temperature shall be taken into account with respect to risk of brittle fracture, to hydrogen embrittlement, to stress corrosion cracking and to resistance to impact. When fine-grain steel is used, the guaranteed value of the yield strength shall be

## Part 6 – Construction and testing of packagings, IBCs, etc.

not more than 460 N/mm<sup>2</sup> and the guaranteed value of the upper limit of the tensile strength shall be not more than 725 N/mm<sup>2</sup>, in accordance with the material specifications. Portable tank materials shall be suitable for the external environment in which they may be transported.

- 6.7.4.2.2 Any part of a portable tank, including fittings, gaskets and pipe-work, which can be expected normally to come into contact with the refrigerated liquefied gas transported shall be compatible with that refrigerated liquefied gas.
- 6.7.4.2.3 Contact between dissimilar metals which could result in damage by galvanic action shall be avoided.
- 6.7.4.2.4 The thermal insulation system shall include a complete covering of the shell(s) with effective insulating materials. External insulation shall be protected by a jacket so as to prevent the ingress of moisture and other damage under normal transport conditions.
- 6.7.4.2.5 When a jacket is so closed as to be gas-tight, a device shall be provided to prevent any dangerous pressure from developing in the insulation space.
- 6.7.4.2.6 Portable tanks intended for the transport of refrigerated liquefied gases having a boiling point below –182°C at atmospheric pressure shall not include materials which may react with oxygen or oxygen-enriched atmospheres in a dangerous manner when located in parts of the thermal insulation when there is a risk of contact with oxygen or with oxygen-enriched fluid.
- 6.7.4.2.7 Insulating materials shall not deteriorate unduly in service.
- 6.7.4.2.8 A reference holding time shall be determined for each refrigerated liquefied gas intended for transport in a portable tank.
- 6.7.4.2.8.1 The reference holding time shall be determined by a method recognized by the competent authority on the basis of the following:
- .1 the effectiveness of the insulation system, determined in accordance with 6.7.4.2.8.2;
  - .2 the lowest set pressure of the pressure-limiting device(s);
  - .3 the initial filling conditions;
  - .4 an assumed ambient temperature of 30°C;
  - .5 the physical properties of the individual refrigerated liquefied gas intended to be transported.
- 6.7.4.2.8.2 The effectiveness of the insulation system (heat influx in watts) shall be determined by type testing the portable tank in accordance with a procedure recognized by the competent authority. This test shall consist of either:
- .1 a constant-pressure test (for example at atmospheric pressure), when the loss of refrigerated liquefied gas is measured over a period of time; or
  - .2 a closed-system test, when the rise in pressure in the shell is measured over a period of time.
- When performing the constant-pressure test, variations in atmospheric pressure shall be taken into account. When performing either test, corrections shall be made for any variation of the ambient temperature from the assumed ambient temperature reference value of 30°C.
- Note:** For the determination of the actual holding time before each journey, see 4.2.3.7.
- 6.7.4.2.9 The jacket of a vacuum-insulated double-wall tank shall have either an external design pressure not less than 100 kPa (1 bar) gauge pressure calculated in accordance with a recognized technical code or a calculated critical collapsing pressure of not less than 200 kPa (2 bar) gauge pressure. Internal and external reinforcements may be included in calculating the ability of the jacket to resist the external pressure.
- 6.7.4.2.10 Portable tanks shall be designed and constructed with supports to provide a secure base during transport and with suitable lifting and tie-down attachments.
- 6.7.4.2.11 Portable tanks shall be designed to withstand, without loss of contents, at least the internal pressure due to the contents and the static, dynamic and thermal loads during normal conditions of handling and transport. The design shall demonstrate that the effects of fatigue, caused by repeated application of these loads through the expected life of the portable tank, have been taken into account.
- 6.7.4.2.11.1 For tanks that are intended for use as offshore tank-containers, the dynamic stresses imposed by handling in open seas shall be taken into account.
- 6.7.4.2.12 Portable tanks and their fastenings under the maximum permissible load shall be capable of absorbing the following separately applied static forces:
- .1 in the direction of travel: twice the MPGM multiplied by the acceleration due to gravity (*g*);\*
  - .2 horizontally at right angles to the direction of travel: the MPGM (when the direction of travel is not clearly determined, the forces shall be equal to twice the MPGM) multiplied by the acceleration due to gravity (*g*);\*

\* For calculation purposes,  $g = 9.81 \text{ m/s}^2$ .

- .3 vertically upwards: the MPGM multiplied by the acceleration due to gravity ( $g$ );\* and
- .4 vertically downwards: twice the MPGM (total loading including the effect of gravity) multiplied by the acceleration due to gravity ( $g$ );\*

6.7.4.2.13 Under each of the forces in 6.7.4.2.12, the safety factor to be observed shall be as follows:

- .1 for materials having a clearly defined yield point, a safety factor of 1.5 in relation to the guaranteed yield strength; or
- .2 for materials with no clearly defined yield point, a safety factor of 1.5 in relation to the guaranteed 0.2% proof strength or, for austenitic steels, the 1% proof strength.

6.7.4.2.14 The values of yield strength or proof strength shall be the values according to national or international material standards. When austenitic steels are used, the specified minimum values according to the material standards may be increased by up to 15% when these greater values are attested in the material inspection certificate. When no material standard exists for the metal in question, or when non-metallic materials are used, the values of yield strength or proof strength shall be approved by the competent authority.

6.7.4.2.15 Portable tanks intended for the transport of flammable refrigerated liquefied gases shall be capable of being electrically earthed.

#### 6.7.4.3 Design criteria

6.7.4.3.1 Shells shall be of a circular cross-section.

6.7.4.3.2 Shells shall be designed and constructed to withstand a test pressure not less than 1.3 times the MAWP. For shells with vacuum insulation, the test pressure shall not be less than 1.3 times the sum of the MAWP and 100 kPa (1 bar). In no case shall the test pressure be less than 300 kPa (3 bar) gauge pressure. Attention is drawn to the minimum shell thickness provisions, specified in 6.7.4.4.2 to 6.7.4.4.7.

6.7.4.3.3 For metals exhibiting a clearly defined yield point or characterized by a guaranteed proof strength (0.2% proof strength, generally, or 1% proof strength for austenitic steels), the primary membrane stress  $\sigma$  (sigma) in the shell shall not exceed  $0.75R_e$  or  $0.50R_m$ , whichever is lower, at the test pressure, where:

$R_e$  = yield strength in N/mm<sup>2</sup>, or 0.2% proof strength or, for austenitic steels, 1% proof strength;

$R_m$  = minimum tensile strength in N/mm<sup>2</sup>.

6.7.4.3.3.1 The values of  $R_e$  and  $R_m$  to be used shall be the specified minimum values according to national or international material standards. When austenitic steels are used, the specified minimum values for  $R_e$  and  $R_m$  according to the material standards may be increased by up to 15% when greater values are attested in the material inspection certificate. When no material standard exists for the metal in question, the values of  $R_e$  and  $R_m$  used shall be approved by the competent authority or its authorized body.

6.7.4.3.3.2 Steels which have a  $R_e/R_m$  ratio of more than 0.85 are not allowed for the construction of welded shells. The values of  $R_e$  and  $R_m$  to be used in determining this ratio shall be the values specified in the material inspection certificate.

6.7.4.3.3.3 Steels used in the construction of shells shall have an elongation at fracture, in %, of not less than  $10,000/R_m$  with an absolute minimum of 16% for fine-grain steels and 20% for other steels. Aluminium and aluminium alloys used in the construction of shells shall have an elongation at fracture, in %, of not less than  $10,000/6R_m$  with an absolute minimum of 12%.

6.7.4.3.3.4 For the purpose of determining actual values for materials, it shall be noted that for sheet metal, the axis of the tensile test specimen shall be at right angles (transversely) to the direction of rolling. The permanent elongation at fracture shall be measured on test specimens of rectangular cross-section in accordance with ISO 6892:1998 using a 50 mm gauge length.

#### 6.7.4.4 Minimum shell thickness

6.7.4.4.1 The minimum shell thickness shall be the greater thickness based on:

- .1 the minimum thickness determined in accordance with the provisions in 6.7.4.4.2 to 6.7.4.4.7; and
- .2 the minimum thickness determined in accordance with the recognized pressure-vessel code, including the provisions in 6.7.4.3.

6.7.4.4.2 Shells of not more than 1.80 m in diameter shall be not less than 5 mm thick in the reference steel or of equivalent thickness in the metal to be used. Shells of more than 1.80 m in diameter shall be not less than 6 mm thick in the reference steel or of equivalent thickness in the metal to be used.

## Part 6 – Construction and testing of packagings, IBCs, etc.

- 6.7.4.4.3 Shells of vacuum-insulated tanks of not more than 1.80 m in diameter shall be not less than 3 mm thick in the reference steel or of equivalent thickness in the metal to be used. Such shells of more than 1.80 m in diameter shall be not less than 4 mm thick in the reference steel or of equivalent thickness in the metal to be used.
- 6.7.4.4.4 For vacuum-insulated tanks, the aggregate thickness of the jacket and the shell shall correspond to the minimum thickness prescribed in 6.7.4.4.2, the thickness of the shell itself being not less than the minimum thickness prescribed in 6.7.4.4.3.
- 6.7.4.4.5 Shells shall be not less than 3 mm thick regardless of the material of construction.
- 6.7.4.4.6 The equivalent thickness of a metal other than the thickness prescribed for the reference steel in 6.7.4.4.2 and 6.7.4.4.3 shall be determined using the following equation:
- $$e_1 = \frac{21.4 \times e_0}{\sqrt[3]{R_{m1} \times A_1}}$$
- where:
- $e_1$  = required equivalent thickness (in mm) of the steel to be used;
  - $e_0$  = minimum thickness (in mm) of the reference steel specified in 6.7.4.4.2 and 6.7.4.4.3;
  - $R_{m1}$  = guaranteed minimum tensile strength (in N/mm<sup>2</sup>) of the metal to be used (see 6.7.4.3.3);
  - $A_1$  = guaranteed minimum elongation at fracture (in %) of the metal to be used according to national or international standards.
- 6.7.4.4.7 In no case shall the wall thickness be less than that prescribed in 6.7.4.4.1 to 6.7.4.4.5. All parts of the shell shall have a minimum thickness as determined by 6.7.4.4.1 to 6.7.4.4.6. This thickness shall be exclusive of any corrosion allowance.
- 6.7.4.4.8 There shall be no sudden change of plate thickness at the attachment of the ends (heads) to the cylindrical portion of the shell.
- 6.7.4.5 Service equipment**
- 6.7.4.5.1 Service equipment shall be so arranged as to be protected against the risk of being wrenched off or damaged during handling and transport. When the connection between the frame and the tank or the jacket and the shell allows relative movement, the equipment shall be so fastened as to permit such movement without risk of damage to working parts. The external discharge fittings (pipe sockets, shut-off devices), the stop-valve and its seating shall be protected against the danger of being wrenched off by external forces (for example, by using shear sections). The filling and discharge devices (including flanges or threaded plugs) and any protective caps shall be capable of being secured against unintended opening.
- 6.7.4.5.1.1 For offshore tank-containers, where positioning of service equipment and the design and strength of protection for such equipment is concerned, the increased danger of impact damage when handling such tanks in open seas shall be taken into account.
- 6.7.4.5.2 Each filling and discharge opening in portable tanks used for the transport of flammable refrigerated liquefied gases shall be fitted with at least three mutually independent shut-off devices in series, the first being a stop-valve situated as close as reasonably practicable to the jacket, the second being a stop-valve and the third being a blank flange or equivalent device. The shut-off device closest to the jacket shall be a quick-closing device, which closes automatically in the event of unintended movement of the portable tank during filling or discharge or fire engulfment. This device shall also be possible to operate by remote control.
- 6.7.4.5.3 Each filling and discharge opening in portable tanks used for the transport of non-flammable refrigerated liquefied gases shall be fitted with at least two mutually independent shut-off devices in series, the first being a stop-valve situated as close as reasonably practicable to the jacket, the second a blank flange or equivalent device.
- 6.7.4.5.4 For sections of piping which can be closed at both ends and where liquid product can be trapped, a method of automatic pressure relief shall be provided to prevent excess pressure build-up within the piping.
- 6.7.4.5.5 Vacuum-insulated tanks need not have an opening for inspection.
- 6.7.4.5.6 External fittings shall be grouped together so far as reasonably practicable.
- 6.7.4.5.7 Each connection on a portable tank shall be clearly marked to indicate its function.
- 6.7.4.5.8 Each stop-valve or other means of closure shall be designed and constructed to a rated pressure not less than the MAWP of the shell, taking into account the temperature expected during transport. All stop-valves with a screwed spindle shall be closed by a clockwise motion of the handwheel. In the case of other stop-valves, the position (open and closed) and direction of closure shall be clearly indicated. All stop-valves shall be designed to prevent unintentional opening.

- 6.7.4.5.9 When pressure-building units are used, the liquid and vapour connections to that unit shall be provided with a valve as close to the jacket as reasonably practicable to prevent the loss of contents in case of damage to the pressure-building unit.
- 6.7.4.5.10 Piping shall be designed, constructed and installed so as to avoid the risk of damage due to thermal expansion and contraction, mechanical shock and vibration. All piping shall be of a suitable material. To prevent leakage due to fire, only steel piping and welded joints shall be used between the jacket and the connection to the first closure of any outlet. The method of attaching the closure to this connection shall be to the satisfaction of the competent authority or its authorized body. Elsewhere, pipe joints shall be welded when necessary.
- 6.7.4.5.11 Joints in copper tubing shall be brazed or have an equally strong metal union. The melting point of brazing materials shall be no lower than 525°C. The joints shall not decrease the strength of the tubing, as may happen by cutting of threads.
- 6.7.4.5.12 The materials of construction of valves and accessories shall have satisfactory properties at the lowest operating temperature of the portable tank.
- 6.7.4.5.13 The burst pressure of all piping and pipe fittings shall be not less than the highest of four times the MAWP of the shell or four times the pressure to which it may be subjected in service by the action of a pump or other device (except pressure relief devices).
- 6.7.4.6 Pressure relief devices**
- 6.7.4.6.1 Every shell shall be provided with not less than two independent spring-loaded pressure relief devices. The pressure relief devices shall open automatically at a pressure not less than the MAWP and be fully open at a pressure equal to 110% of the MAWP. These devices shall, after discharge, close at a pressure not lower than 10% below the pressure at which discharge starts and shall remain closed at all lower pressures. The pressure relief devices shall be of the type that will resist dynamic forces, including surge.
- 6.7.4.6.2 Shells for non-flammable refrigerated liquefied gases and hydrogen may in addition have frangible discs in parallel with the spring-loaded devices as specified in 6.7.4.7.2 and 6.7.4.7.3.
- 6.7.4.6.3 Pressure relief devices shall be designed to prevent the entry of foreign matter, the leakage of gas and the development of any dangerous excess pressure.
- 6.7.4.6.4 Pressure relief devices shall be approved by the competent authority or its authorized body.
- 6.7.4.7 Capacity and setting of pressure relief devices**
- 6.7.4.7.1 In the case of the loss of vacuum in a vacuum-insulated tank or of loss of 20% of the insulation of a tank insulated with solid materials, the combined capacity of all pressure relief devices installed shall be sufficient so that the pressure (including accumulation) inside the shell does not exceed 120% of the MAWP.
- 6.7.4.7.2 For non-flammable refrigerated liquefied gases (except oxygen) and hydrogen, this capacity may be achieved by the use of frangible discs in parallel with the required safety relief devices. Frangible discs shall rupture at nominal pressure equal to the test pressure of the shell.
- 6.7.4.7.3 Under the circumstances described in 6.7.4.7.1 and 6.7.4.7.2 together with complete fire engulfment, the combined capacity of all pressure relief devices installed shall be sufficient to limit the pressure in the shell to the test pressure.
- 6.7.4.7.4 The required capacity of the relief devices shall be calculated in accordance with a well-established technical code recognized by the competent authority.\*
- 6.7.4.8 Marking of pressure relief devices**
- 6.7.4.8.1 Every pressure relief device shall be plainly and permanently marked with the following:
- .1 the pressure (in bar or kPa) at which it is set to discharge;
  - .2 the allowable tolerance at the discharge pressure, for spring-loaded devices;
  - .3 the reference temperature corresponding to the rated pressure, for frangible discs; and
  - .4 the rated flow capacity of the device in standard cubic metres of air per second (m<sup>3</sup>/s).
  - .5 The cross sectional flow areas of the spring loaded pressure-relief devices and frangible discs in mm<sup>2</sup>.
- When practicable, the following information shall also be shown:

\* See, for example, CGA S-1.2-2003 "Pressure Relief Device Standards – Part 2 – Cargo and Portable Tanks for Compressed Gases."

## Part 6 – Construction and testing of packagings, IBCs, etc.

- .6 the manufacturer's name and relevant catalogue number.
- 6.7.4.8.2 The rated flow capacity marked on the pressure relief devices shall be determined according to ISO 4126 1:2004 and ISO 4126-7:2004.
- 6.7.4.9 Connections to pressure relief devices**
- 6.7.4.9.1 Connections to pressure relief devices shall be of sufficient size to enable the required discharge to pass unrestricted to the safety device. No stop-valve shall be installed between the shell and the pressure relief devices except when duplicate devices are provided for maintenance or other reasons and the stop-valves serving the devices actually in use are locked open or the stop-valves are interlocked so that the provisions of 6.7.4.7 are always fulfilled. There shall be no obstruction in an opening leading to a vent or pressure relief device which might restrict or cut off the flow from the shell to that device. Pipework to vent the vapour or liquid from the outlet of the pressure relief devices, when used, shall deliver the relieved vapour or liquid to the atmosphere in conditions of minimum back-pressure on the relieving device
- 6.7.4.10 Siting of pressure relief devices**
- 6.7.4.10.1 Each pressure relief device inlet shall be situated on top of the shell in a position as near the longitudinal and transverse centre of the shell as reasonably practicable. All pressure relief device inlets shall, under maximum filling conditions, be situated in the vapour space of the shell and the devices shall be so arranged as to ensure that the escaping vapour is discharged unrestrictedly. For refrigerated liquefied gases, the escaping vapour shall be directed away from the tank and in such a manner that it cannot impinge upon the tank. Protective devices which deflect the flow of vapour are permissible provided the required relief-device capacity is not reduced.
- 6.7.4.10.2 Arrangements shall be made to prevent access to the devices by unauthorized persons and to protect the devices from damage caused by the portable tank overturning.
- 6.7.4.11 Gauging devices**
- 6.7.4.11.1 Unless a portable tank is intended to be filled by mass, it shall be equipped with one or more gauging devices. Glass level-gauges and gauges made of other fragile material, which are in direct communication with the contents of the shell, shall not be used.
- 6.7.4.11.2 A connection for a vacuum gauge shall be provided in the jacket of a vacuum-insulated portable tank.
- 6.7.4.12 Portable tank supports, frameworks, lifting and tie-down attachments**
- 6.7.4.12.1 Portable tanks shall be designed and constructed with a support structure to provide a secure base during transport. The forces specified in 6.7.4.2.12 and the safety factor specified in 6.7.4.2.13 shall be considered in this aspect of the design. Skids, frameworks, cradles or other similar structures are acceptable.
- 6.7.4.12.2 The combined stresses caused by portable tank mountings (such as cradles, frameworks, etc.) and portable tank lifting and tie-down attachments shall not cause excessive stress in any portion of the tank. Permanent lifting and tie-down attachments shall be fitted to all portable tanks. Preferably they shall be fitted to the portable tank supports but may be secured to reinforcing plates located on the tank at the points of support.
- 6.7.4.12.3 In the design of supports and frameworks, the effects of environmental corrosion shall be taken into account.
- 6.7.4.12.4 Forklift pockets shall be capable of being closed off. The means of closing forklift pockets shall be a permanent part of the framework or permanently attached to the framework. Single-compartment portable tanks with a length less than 3.65 m need not have closed-off forklift pockets provided that:
- .1 the tank and all the fittings are well protected from being hit by the forklift blades; and
  - .2 the distance between the centres of the forklift pockets is at least half of the maximum length of the portable tank.
- 6.7.4.12.5 When portable tanks are not protected during transport, according to 4.2.3.3, the shells and service equipment shall be protected against damage to the shell and service equipment resulting from lateral or longitudinal impact or overturning. External fittings shall be protected so as to preclude the release of the shell contents upon impact or overturning of the portable tank on its fittings. Examples of protection include:
- .1 protection against lateral impact, which may consist of longitudinal bars protecting the shell on both sides at the level of the median line;
  - .2 protection of the portable tank against overturning, which may consist of reinforcement rings or bars fixed across the frame;
  - .3 protection against rear impact, which may consist of a bumper or frame;

- .4 protection of the shell against damage from impact or overturning by use of an ISO frame in accordance with ISO 1496-3:1995;
- .5 protection of the portable tank from impact or overturning by a vacuum insulation jacket.

**6.7.4.13 Design approval**

**6.7.4.13.1** The competent authority or its authorized body shall issue a design approval certificate for any new design of a portable tank. This certificate shall attest that a portable tank has been surveyed by that authority, is suitable for its intended purpose and meets the provisions of this chapter. When a series of portable tanks are manufactured without change in the design, the certificate shall be valid for the entire series. The certificate shall refer to the prototype test report, the refrigerated liquefied gases allowed to be transported, the materials of construction of the shell and jacket and an approval number. The approval number shall consist of the distinguishing sign or mark of the State in whose territory the approval was granted, i.e., the distinguishing sign for use in international traffic, as prescribed by the Convention on Road Traffic, Vienna, 1968, and a registration number. Any alternative arrangements according to 6.7.1.2 shall be indicated on the certificate. A design approval may serve for the approval of smaller portable tanks made of materials of the same kind and thickness, by the same fabrication techniques and with identical supports, equivalent closures and other apertures.

**6.7.4.13.2** The prototype test report for the design approval shall include at least the following:

- .1 the results of the applicable framework test specified in ISO 1496-3:1995;
- .2 the results of the initial inspection and test in 6.7.4.14.3; and
- .3 the results of the impact test in 6.7.4.14.1, when applicable.

**6.7.4.14 Inspection and testing**

**6.7.4.14.1** Portable tanks meeting the definition of *container* in the International Convention for Safe Containers (CSC), 1972, as amended, shall not be used unless they are successfully qualified by subjecting a representative prototype of each design to the Dynamic, Longitudinal Impact Test prescribed in the United Nations *Manual of Tests and Criteria*, part IV, section 41. This provision only applies to portable tanks which are constructed according to a design approval certificate which has been issued on or after 1 January 2008.

**6.7.4.14.2** The tank and items of equipment of each portable tank shall be inspected and tested before being put into service for the first time (initial inspection and test) and thereafter at not more than five-year intervals (5-year periodic inspection and test) with an intermediate periodic inspection and test (2.5-year periodic inspection and test) midway between the 5-year periodic inspections and tests. The 2.5-year periodic inspection and test may be performed within 3 months of the specified date. An exceptional inspection and test shall be performed regardless of the last periodic inspection and test when necessary according to 6.7.4.14.7.

**6.7.4.14.3** The initial inspection and test of a portable tank shall include a check of the design characteristics, an internal and external examination of the portable tank shell and its fittings with due regard to the refrigerated liquefied gases to be transported, and a pressure test referring to the test pressures according to 6.7.4.3.2. The pressure test may be performed as a hydraulic test or by using another liquid or gas, with the agreement of the competent authority or its authorized body. Before the portable tank is placed into service, a leakproofness test and a test of the satisfactory operation of all service equipment shall also be performed. When the shell and its fittings have been pressure-tested separately, they shall be subjected together after assembly to a leakproofness test. All welds subject to full stress level shall be inspected during the initial test by radiographic, ultrasonic, or another suitable non-destructive test method. This does not apply to the jacket.

**6.7.4.14.4** The 5-year and 2.5-year periodic inspections and tests shall include an external examination of the portable tank and its fittings with due regard to the refrigerated liquefied gases transported, a leakproofness test, a test of the satisfactory operation of all service equipment and a vacuum reading, when applicable. In the case of non-vacuum-insulated tanks, the jacket and insulation shall be removed during the 2.5-year and the 5-year periodic inspections and tests, but only to the extent necessary for a reliable appraisal.

**6.7.4.14.5** [Reserved]

**6.7.4.14.6** A portable tank may not be filled and offered for transport after the date of expiry of the last 5-year or 2.5-year periodic inspection and test as required by 6.7.4.14.2. However, a portable tank filled prior to the date of expiry of the last periodic inspection and test may be transported for a period not to exceed three months beyond the date of expiry of the last periodic test or inspection. In addition, a portable tank may be transported after the date of expiry of the last periodic test and inspection:

- .1 after emptying but before cleaning, for purposes of performing the next required test or inspection prior to refilling; and
- .2 unless otherwise approved by the competent authority, for a period not to exceed six months beyond the date of expiry of the last periodic test or inspection, in order to allow the return of dangerous goods for proper disposal or recycling. Reference to this exemption shall be mentioned in the transport document.

Part 6 – Construction and testing of packagings, IBCs, etc.

---

- 6.7.4.14.7 The exceptional inspection and test is necessary when the portable tank shows evidence of damaged or corroded areas, leakage, or any other conditions that indicate a deficiency that could affect the integrity of the portable tank. The extent of the exceptional inspection and test shall depend on the amount of damage or deterioration of the portable tank. It shall include at least the 2.5-year periodic inspection and test according to 6.7.4.14.4.
- 6.7.4.14.8 The internal examination during the initial inspection and test shall ensure that the shell is inspected for pitting, corrosion, or abrasions, dents, distortions, defects in welds or any other conditions that might render the portable tank unsafe for transport.
- 6.7.4.14.9 The external examination shall ensure that:
- .1 the external piping, valves, pressurizing/cooling systems when applicable, and gaskets are inspected for corroded areas, defects, or any other conditions, including leakage, that might render the portable tank unsafe for filling, discharge or transport;
  - .2 there is no leakage at any manhole covers or gaskets;
  - .3 missing or loose bolts or nuts on any flanged connection or blank flange are replaced or tightened;
  - .4 all emergency devices and valves are free from corrosion, distortion and any damage or defect that could prevent their normal operation. Remote closure devices and self-closing stop-valves shall be operated to demonstrate proper operation;
  - .5 required markings on the portable tank are legible and in accordance with the applicable provisions; and
  - .6 the framework, the supports and the arrangements for lifting the portable tank are in satisfactory condition.
- 6.7.4.14.10 The inspections and tests in 6.7.4.14.1, 6.7.4.14.3, 6.7.4.14.4 and 6.7.4.14.7 shall be performed or witnessed by an expert approved by the competent authority or its authorized body. When the pressure test is a part of the inspection and test, the test pressure shall be the one indicated on the data plate of the portable tank. While under pressure, the portable tank shall be inspected for any leaks in the shell, piping or equipment.
- 6.7.4.14.11 In all cases when cutting, burning or welding operations on the shell of a portable tank have been effected, that work shall be to the approval of the competent authority or its authorized body, taking into account the pressure-vessel code used for the construction of the shell. A pressure test to the original test pressure shall be performed after the work is completed.
- 6.7.4.14.12 When evidence of any unsafe condition is discovered, the portable tank shall not be returned to service until it has been corrected and the test is repeated and passed.
- 6.7.4.15 **Marking**
- 6.7.4.15.1 Every portable tank shall be fitted with a corrosion-resistant metal plate permanently attached to the portable tank in a conspicuous place readily accessible for inspection. When for reasons of portable tank arrangements the plate cannot be permanently attached to the shell, the shell shall be marked with at least the information required by the pressure-vessel code. As a minimum, at least the following information shall be marked on the plate by stamping or by any other similar method:
- (a) Owner information
    - (i) Owner's registration number;
  - (b) Manufacturing information
    - (i) Country of manufacture;
    - (ii) Year of manufacture;
    - (iii) Manufacturer's name or mark;
    - (iv) Manufacturer's serial number;
  - (c) Approval information
    - (i) The United Nations packaging symbol 

This symbol shall not be used for any purpose other than certifying that a packaging, a flexible bulk container, a portable tank or a MEGC complies with the relevant requirements in Chapter 6.1, 6.2, 6.3, 6.5, 6.6, 6.7 or 6.9;

    - (ii) Approval country;
    - (iii) Authorized body for the design approval;
    - (iv) Design approval number;
    - (v) Letters "AA", if the design was approved under alternative arrangements (see 6.7.1.2);
    - (vi) Pressure-vessel code to which the shell is designed;



- (d) Pressures
  - (i) MAWP (in bar gauge or kPa gauge);\*
  - (ii) Test pressure (in bar gauge or kPa gauge);\*
  - (iii) Initial pressure test date (month and year);
  - (iv) Identification mark of the initial pressure test witness;
- (e) Temperatures
  - (i) Minimum design temperature (in °C);†
- (f) Materials
  - (i) Shell material(s) and material standard reference(s);
  - (ii) Equivalent thickness in reference steel (in mm);\*
- (g) Capacity
  - (i) Tank water capacity at 20°C (in litres);\*
- (h) Insulation
  - (i) Either “Thermally insulated” or “Vacuum insulated” (as applicable);
  - (ii) Effectiveness of the insulation system (heat influx) (in Watts);\*
- (i) Holding times – For each refrigerated liquefied gas permitted to be transported in the portable tank:
  - (i) Name, in full, of the refrigerated liquefied gas;
  - (ii) Reference holding time (in days or hours);\*
  - (iii) Initial pressure (in bar gauge or kPa gauge);\*
  - (iv) Degree of filling (in kg);\*
- (j) Periodic inspections and tests
  - (i) Type of the most recent periodic test (2.5-year, 5-year or exceptional);
  - (ii) Date of the most recent periodic test (month and year);
  - (iii) Identification mark of the authorized body who performed or witnessed the most recent test.

---

\* The unit used shall be indicated.

† The unit used shall be indicated.

Part 6 – Construction and testing of packagings, IBCs, etc.

Figure 6.7.4.15.1 – Example of identification plate marking

Owner's registration number					
<b>MANUFACTURING INFORMATION</b>					
Country of manufacture					
Year of manufacture					
Manufacturer					
Manufacturer's serial number					
<b>APPROVAL INFORMATION</b>					
	Approval country				
	Authorized body for design approval				
	Design approval number	"AA" (if applicable)			
Shell design code (pressure-vessel code)					
<b>PRESSURES</b>					
MAWP		bar or kPa			
Test pressure		bar or kPa			
Initial pressure test date:	(mm/yyyy)	Witness stamp:			
<b>TEMPERATURES</b>					
Minimum design temperature		°C			
<b>MATERIALS</b>					
Shell material(s) and material standard reference(s)					
Equivalent thickness in reference steel		mm			
<b>CAPACITY</b>					
Tank water capacity at 20°C		litres			
<b>INSULATION</b>					
"Thermally insulated" or "Vacuum insulated" (as applicable)					
Heat influx		Watts			
<b>HOLDING TIMES</b>					
Refrigerated liquefied gas(es) permitted	Reference holding time	Initial pressure	Degree of filling		
	days or hours	bar or kPa	kg		
<b>PERIODIC INSPECTIONS/TESTS</b>					
Test type	Test date	Witness stamp	Test type	Test date	Witness stamp
	(mm/yyyy)			(mm/yyyy)	

- 6.7.4.15.2 The following information shall be durably marked either on the portable tank itself or on a metal plate firmly secured to the portable tank:
- Name of the owner and the operator
  - Name of the refrigerated liquefied gas being transported (and minimum mean bulk temperature)
  - Maximum permissible gross mass (MPGM) . . . . . kg
  - Unladen (tare) mass . . . . . kg
  - Actual holding time for gas being transported . . . . . days (or hours)
  - Portable tank instruction in accordance with 4.2.5.2.6.

- 6.7.4.15.3 If a portable tank is designed and approved for handling in open seas, the words “OFFSHORE PORTABLE TANK” shall be marked on the identification plate.

**6.7.5 Provisions for the design, construction, inspection and testing of multiple-element gas containers (MEGCs) intended for the transport of non-refrigerated gases**

**6.7.5.1 Definitions**

For the purposes of this section:

*Elements* are cylinders, tubes or bundles of cylinders;

*Leakproofness test* means a test, using gas, subjecting the elements and the service equipment of the MEGC to an effective internal pressure of not less than 20% of the test pressure;

*Manifold* means an assembly of piping and valves connecting the filling and/or discharge openings of the elements;

*Maximum permissible gross mass (MPGM)* means the sum of the tare mass of the MEGC and the heaviest load authorized for transport;

*Service equipment* means measuring instruments and filling, discharge, venting and safety devices;

*Structural equipment* means the reinforcing, fastening, protective and stabilizing members external to the elements.

**6.7.5.2 General design and construction provisions**

- 6.7.5.2.1 The MEGC shall be capable of being filled and discharged without the removal of its structural equipment. It shall possess stabilizing members external to the elements to provide structural integrity for handling and transport. MEGCs shall be designed and constructed with supports to provide a secure base during transport and with lifting and tie-down attachments which are adequate for lifting the MEGC, including when loaded to its maximum permissible gross mass. The MEGC shall be designed to be loaded onto or into a vehicle or ship and shall be equipped with skids, mountings or accessories to facilitate mechanical handling.

- 6.7.5.2.2 MEGCs shall be designed, manufactured and equipped in such a way as to withstand all conditions to which they will be subjected during normal conditions of handling and transport. The design shall take into account the effects of dynamic loading and fatigue.

- 6.7.5.2.3 Elements of an MEGC shall be made of seamless steel and be constructed and tested according to chapter 6.2. All of the elements in an MEGC shall be of the same design type.

- 6.7.5.2.4 Elements of MEGCs, fittings and pipework shall be:
- .1 compatible with the substances intended to be transported (for gases, see ISO 11114-1:1997 and ISO 11114-2:2000); or
  - .2 properly passivated or neutralized by chemical reaction.

- 6.7.5.2.5 Contact between dissimilar metals which could result in damage by galvanic action shall be avoided.

- 6.7.5.2.6 The materials of the MEGC, including any devices, gaskets, and accessories, shall not adversely affect the gases intended for transport in the MEGC.

- 6.7.5.2.7 MEGCs shall be designed to withstand, without loss of contents, at least the internal pressure due to the contents, and the static, dynamic and thermal loads during normal conditions of handling and transport. The design shall demonstrate that the effects of fatigue, caused by repeated application of these loads through the expected life of the multiple-element gas container, have been taken into account.

## Part 6 – Construction and testing of packagings, IBCs, etc.

- 6.7.5.2.8 MEGCs and their fastenings shall, under the maximum permissible load, be capable of withstanding the following separately applied static forces:
- .1 in the direction of travel: twice the MPGM multiplied by the acceleration due to gravity ( $g$ );\*
  - .2 horizontally at right angles to the direction of travel: the MPGM (when the direction of travel is not clearly determined, the forces shall be equal to twice the MPGM) multiplied by the acceleration due to gravity ( $g$ );\*
  - .3 vertically upwards: the MPGM multiplied by the acceleration due to gravity ( $g$ );\* and
  - .4 vertically downwards: twice the MPGM (total loading including the effect of gravity) multiplied by the acceleration due to gravity ( $g$ );\*
- 6.7.5.2.9 Under the forces defined above, the stress at the most severely stressed point of the elements shall not exceed the values given in either the relevant standards of 6.2.2.1 or, if the elements are not designed, constructed and tested according to those standards, in the technical code or standard recognized or approved by the competent authority of the country of use (see 6.2.3.1).
- 6.7.5.2.10 Under each of the forces in 6.7.5.2.8, the safety factor for the framework and fastenings to be observed shall be as follows:
- .1 for steels having a clearly defined yield point, a safety factor of 1.5 in relation to the guaranteed yield strength; or
  - .2 for steels with no clearly defined yield point, a safety factor of 1.5 in relation to the guaranteed 0.2% proof strength and, for austenitic steels, the 1% proof strength.
- 6.7.5.2.11 MEGCs intended for the transport of flammable gases shall be capable of being electrically earthed.
- 6.7.5.2.12 The elements shall be secured in a manner that prevents undesired movement in relation to the structure and the concentration of harmful localized stresses.
- 6.7.5.3 Service equipment**
- 6.7.5.3.1 Service equipment shall be configured or designed to prevent damage that could result in the release of the pressure receptacle contents during normal conditions of handling and transport. When the connection between the frame and the elements allows relative movement between the sub-assemblies, the equipment shall be so fastened as to permit such movement without damage to working parts. The manifolds, the discharge fittings (pipe sockets, shut-off devices), and the stop-valves shall be protected from being wrenched off by external forces. Manifold piping leading to shut-off valves shall be sufficiently flexible to protect the valves and the piping from shearing, or releasing the pressure receptacle contents. The filling and discharge devices (including flanges or threaded plugs) and any protective caps shall be capable of being secured against unintended opening.
- 6.7.5.3.2 Each element intended for the transport of gases of class 2.3 shall be fitted with a valve. The manifold for liquefied gases of class 2.3 shall be so designed that the elements can be filled separately and be kept isolated by a valve capable of being sealed. For the transport of gases of class 2.1, the elements shall be divided into groups of not more than 3000 litres each isolated by a valve.
- 6.7.5.3.3 For filling and discharge openings of the MEGC, two valves in series shall be placed in an accessible position on each discharge and filling pipe. One of the valves may be a non-return valve. The filling and discharge devices may be fitted to a manifold. For sections of piping which can be closed at both ends and where a liquid product can be trapped, a pressure relief valve shall be provided to prevent excessive pressure build-up. The main isolation valves on an MEGC shall be clearly marked to indicate their directions of closure. Each stop-valve or other means of closure shall be designed and constructed to withstand a pressure equal to or greater than 1.5 times the test pressure of the MEGC. All stop-valves with screwed spindles shall close by a clockwise motion of the handwheel. For other stop-valves, the positions (open and closed) and direction of closure shall be clearly indicated. All stop-valves shall be designed and positioned to prevent unintentional opening. Ductile metals shall be used in the construction of valves or accessories.
- 6.7.5.3.4 Piping shall be designed, constructed and installed so as to avoid damage due to expansion and contraction, mechanical shock and vibration. Joints in tubing shall be brazed or have an equally strong metal union. The melting point of brazing materials shall be no lower than 525°C. The rated pressure of the service equipment and of the manifold shall be not less than two thirds of the test pressure of the elements.
- 6.7.5.4 Pressure relief devices**
- 6.7.5.4.1 The elements of MEGCs used for the transport of UN 1013 carbon dioxide and UN 1070 nitrous oxide shall be divided into groups of not more than 3000 litres each isolated by a valve. Each group shall be fitted with one

\* For calculation purposes,  $g = 9.81 \text{ m/s}^2$ .

*Chapter 6.7 – Design, construction, inspection and testing of portable tanks & MEGCs*

or more pressure relief devices. If so required by the competent authority of the country of use, MEGCs for other gases shall be fitted with pressure relief devices as specified by that competent authority.

- 6.7.5.4.2** When pressure relief devices are fitted, every element or group of elements of an MEGC that can be isolated shall then be fitted with one or more pressure relief devices. Pressure relief devices shall be of a type that will resist dynamic forces, including liquid surge, and shall be designed to prevent the entry of foreign matter, the leakage of gas and the development of any dangerous excess pressure.
- 6.7.5.4.3** MEGCs used for the transport of certain non-refrigerated gases identified in instruction T50 in 4.2.5.2.6 may have a pressure relief device as required by the competent authority of the country of use. Unless an MEGC in dedicated service is fitted with an approved pressure relief device constructed of materials compatible with the load, such a device shall comprise a frangible disc preceding a spring-loaded device. The space between the frangible disc and the spring-loaded device may be equipped with a pressure gauge or a suitable tell-tale indicator. This arrangement permits the detection of disc rupture, pinholing or leakage which could cause a malfunction of the pressure relief device. The frangible disc shall rupture at a nominal pressure 10% above the start-to-discharge pressure of the spring-loaded device.
- 6.7.5.4.4** In the case of multi-purpose MEGCs used for the transport of low-pressure liquefied gases, the pressure relief devices shall open at a pressure as specified in 6.7.3.7.1 for the gas having the highest maximum allowable working pressure of the gases allowed to be transported in the MEGC.
- 6.7.5.5 Capacity of pressure relief devices**
- 6.7.5.5.1** The combined delivery capacity of the pressure relief devices when fitted shall be sufficient that, in the event of complete fire engulfment of the MEGC, the pressure (including accumulation) inside the elements does not exceed 120% of the set pressure of the pressure relief device. The formula provided in CGA S-1.2-2003 "Pressure Relief Device Standards, Part 2, Cargo and Portable Tanks for Compressed Gases" shall be used to determine the minimum total flow capacity for the system of pressure relief devices. CGA S-1.1-2003 "Pressure Relief Device Standards, Part 1, Cylinders for Compressed Gases" may be used to determine the relief capacity of individual elements. Spring-loaded pressure relief devices may be used to achieve the full relief capacity prescribed in the case of low-pressure liquefied gases. In the case of multi-purpose MEGCs, the combined delivery capacity of the pressure relief devices shall be taken for the gas which requires the highest delivery capacity of the gases allowed to be transported in the MEGC.
- 6.7.5.5.2** To determine the total required capacity of the pressure relief devices installed on the elements for the transport of liquefied gases, the thermodynamic properties of the gas shall be considered (see, for example, CGA S-1.2-2003 "Pressure Relief Device Standards, Part 2, Cargo and Portable Tanks for Compressed Gases" for low-pressure liquefied gases and CGA S-1.1-2003 "Pressure Relief Device Standards, Part 1, Cylinders for Compressed Gases" for high-pressure liquefied gases).
- 6.7.5.6 Marking of pressure relief devices**
- 6.7.5.6.1** Pressure relief devices shall be clearly and permanently marked with the following:
- (a) the manufacturer's name and relevant catalogue number;
  - (b) the set pressure and/or the set temperature;
  - (c) the date of the last test.
  - (d) The cross sectional flow areas of the spring loaded pressure-relief devices and frangible discs in mm<sup>2</sup>.
- 6.7.5.6.2** The rated flow capacity marked on spring-loaded pressure relief devices for low-pressure liquefied gases shall be determined according to ISO 4126 1:2004 and ISO 4126-7:2004.
- 6.7.5.7 Connections to pressure relief devices**
- 6.7.5.7.1** Connections to pressure relief devices shall be of sufficient size to enable the required discharge to pass unrestricted to the pressure relief device. No stop-valve shall be installed between the element and the pressure relief devices, except when duplicate devices are provided for maintenance or other reasons, and the stop-valves serving the devices actually in use are locked open, or the stop-valves are interlocked so that at least one of the duplicate devices is always operable and capable of meeting the requirements of 6.7.5.5. There shall be no obstruction in an opening leading to or leaving from a vent or pressure relief device which might restrict or cut off the flow from the element to that device. The opening through all piping and fittings shall have at least the same flow area as the inlet of the pressure relief device to which it is connected. The nominal size of the discharge piping shall be at least as large as that of the pressure relief device outlet. Vents from the pressure relief devices, when used, shall deliver the relieved vapour or liquid to the atmosphere in conditions of minimum back-pressure on the relieving device.

## Part 6 – Construction and testing of packagings, IBCs, etc.

**6.7.5.8 Siting of pressure relief devices**

- 6.7.5.8.1** Each pressure relief device shall, under maximum filling conditions, be in communication with the vapour space of the elements for the transport of liquefied gases. The devices, when fitted, shall be so arranged as to ensure that the escaping vapour is discharged upwards and unrestrictedly so as to prevent any impingement of escaping gas or liquid upon the MEGC, its elements or personnel. For flammable and pyrophoric and oxidizing gases, the escaping gas shall be directed away from the element in such a manner that it cannot impinge upon the other elements. Heat-resistant protective devices which deflect the flow of gas are permissible provided the required pressure relief device capacity is not reduced.
- 6.7.5.8.2** Arrangements shall be made to prevent access to the pressure relief devices by unauthorized persons and to protect the devices from damage caused by the MEGC overturning.

**6.7.5.9 Gauging devices**

- 6.7.5.9.1** When an MEGC is intended to be filled by mass, it shall be equipped with one or more gauging devices. Level-gauges made of glass or other fragile material shall not be used.

**6.7.5.10 MEGC supports, frameworks, lifting and tie-down attachments**

- 6.7.5.10.1** MEGCs shall be designed and constructed with a support structure to provide a secure base during transport. The forces specified in 6.7.5.2.8 and the safety factor specified in 6.7.5.2.10 shall be considered in this aspect of the design. Skids, frameworks, cradles or other similar structures are acceptable.
- 6.7.5.10.2** The combined stresses caused by element mountings (e.g., cradles, frameworks, etc.) and MEGC lifting and tie-down attachments shall not cause excessive stress in any element. Permanent lifting and tie-down attachments shall be fitted to all MEGCs. In no case shall mountings or attachments be welded onto the elements.
- 6.7.5.10.3** In the design of supports and frameworks, the effects of environmental corrosion shall be taken into account.
- 6.7.5.10.4** When MEGCs are not protected during transport, according to 4.2.4.3, the elements and service equipment shall be protected against damage resulting from lateral or longitudinal impact or overturning. External fittings shall be protected so as to preclude the release of the elements' contents upon impact or overturning of the MEGC on its fittings. Particular attention shall be paid to the protection of the manifold. Examples of protection include:
- .1 protection against lateral impact, which may consist of longitudinal bars;
  - .2 protection against overturning, which may consist of reinforcement rings or bars fixed across the frame;
  - .3 protection against rear impact, which may consist of a bumper or frame;
  - .4 protection of the elements and service equipment against damage from impact or overturning by use of an ISO frame in accordance with the relevant provisions of ISO 1496-3:1995.

**6.7.5.11 Design approval**

- 6.7.5.11.1** The competent authority or its authorized body shall issue a design approval certificate for any new design of an MEGC. This certificate shall attest that the MEGC has been surveyed by that authority, is suitable for its intended purpose and meets the requirements of this chapter, the applicable provisions for gases of chapter 4.1 and of packing instruction P200. When a series of MEGCs are manufactured without change in the design, the certificate shall be valid for the entire series. The certificate shall refer to the prototype test report, the materials of construction of the manifold, the standards to which the elements are made and an approval number. The approval number shall consist of the distinguishing sign or mark of the country granting the approval, i.e., the distinguishing sign for use in international traffic, as prescribed by the Convention on Road Traffic, Vienna, 1968, and a registration number. Any alternative arrangements according to 6.7.1.2 shall be indicated on the certificate. A design approval may serve for the approval of smaller MEGCs made of materials of the same type and thickness, by the same fabrication techniques and with identical supports, equivalent closures and other appurtenances.
- 6.7.5.11.2** The prototype test report for the design approval shall include at least the following:
- .1 the results of the applicable framework test specified in ISO 1496-3:1995;
  - .2 the results of the initial inspection and test specified in 6.7.5.12.3;
  - .3 the results of the impact test specified in 6.7.5.12.1; and
  - .4 certification documents verifying that the cylinders and tubes comply with the applicable standards.

- 6.7.5.12 Inspection and testing**
- 6.7.5.12.1** MEGCs meeting the definition of *container* in the International Convention for Safe Containers (CSC), 1972, as amended, shall not be used unless they are successfully qualified by subjecting a representative prototype of each design to the Dynamic, Longitudinal Impact Test prescribed in the United Nations *Manual of Tests and Criteria*, part IV, section 41. This provision only applies to MEGCs which are constructed according to a design approval certificate which has been issued on or after 1 January 2008.
- 6.7.5.12.2** The elements and items of equipment of each MEGC shall be inspected and tested before being put into service for the first time (initial inspection and test). Thereafter, MEGCs shall be inspected at no more than five-year intervals (5-year periodic inspection). An exceptional inspection and test shall be performed, regardless of the last periodic inspection and test, when necessary according to 6.7.5.12.5.
- 6.7.5.12.3** The initial inspection and test of an MEGC shall include a check of the design characteristics, an external examination of the MEGC and its fittings with due regard to the gases to be transported, and a pressure test performed at the test pressures according to packing instruction P200. The pressure test of the manifold may be performed as a hydraulic test or by using another liquid or gas with the agreement of the competent authority or its authorized body. Before the MEGC is placed into service, a leakproofness test and a test of the satisfactory operation of all service equipment shall also be performed. When the elements and their fittings have been pressure-tested separately, they shall be subjected together after assembly to a leakproofness test.
- 6.7.5.12.4** The 5-year periodic inspection and test shall include an external examination of the structure, the elements and the service equipment in accordance with 6.7.5.12.6. The elements and the piping shall be tested at the periodicity specified in packing instruction P200 and in accordance with the provisions described in 6.2.1.6. When the elements and equipment have been pressure-tested separately, they shall be subjected together after assembly to a leakproofness test.
- 6.7.5.12.5** An exceptional inspection and test is necessary when the MEGC shows evidence of damaged or corroded areas, leakage, or other conditions that indicate a deficiency that could affect the integrity of the MEGC. The extent of the exceptional inspection and test shall depend on the amount of damage or deterioration of the MEGC. It shall include at least the examinations required under 6.7.5.12.6.
- 6.7.5.12.6** The examinations shall ensure that:
- .1 the elements are inspected externally for pitting, corrosion, abrasions, dents, distortions, defects in welds or any other conditions, including leakage, that might render the MEGC unsafe for transport;
  - .2 the piping, valves, and gaskets are inspected for corroded areas, defects, and other conditions, including leakage, that might render the MEGC unsafe for filling, discharge or transport;
  - .3 missing or loose bolts or nuts on any flanged connection or blank flange are replaced or tightened;
  - .4 all emergency devices and valves are free from corrosion, distortion and any damage or defect that could prevent their normal operation. Remote closure devices and self-closing stop-valves shall be operated to demonstrate proper operation;
  - .5 required markings on the MEGC are legible and in accordance with the applicable requirements; and
  - .6 the framework, the supports and the arrangements for lifting the MEGC are in satisfactory condition.
- 6.7.5.12.7** The inspections and tests in 6.7.5.12.1, 6.7.5.12.3, 6.7.5.12.4 and 6.7.5.12.5 shall be performed or witnessed by a body authorized by the competent authority. When the pressure test is a part of the inspection and test, the test pressure shall be the one indicated on the data plate of the MEGC. While under pressure, the MEGC shall be inspected for any leaks in the elements, piping or equipment.
- 6.7.5.12.8** When evidence of any unsafe condition is discovered, the MEGC shall not be returned to service until it has been corrected and the applicable tests and verifications are passed.
- 6.7.5.13 Marking**
- 6.7.5.13.1** Every MEGC shall be fitted with a corrosion-resistant metal plate permanently attached to the MEGC in a conspicuous place readily accessible for inspection. The metal plate shall not be affixed to the elements. The elements shall be marked in accordance with chapter 6.2. As a minimum, at least the following information shall be marked on the plate by stamping or by any other similar method:
- (a) Owner information
    - (i) Owner's registration number;
  - (b) Manufacturing information
    - (i) Country of manufacture;
    - (ii) Year of manufacture;
    - (iii) Manufacturer's name or mark;

Part 6 – Construction and testing of packagings, IBCs, etc.

---

- (iv) Manufacturer's serial number;
- (c) Approval information
  - (i) The United Nations packaging symbol



This symbol shall not be used for any purpose other than certifying that a packaging, a flexible bulk container, a portable tank or a MEGC complies with the relevant requirements in Chapter 6.1, 6.2, 6.3, 6.5, 6.6, 6.7 or 6.9;

- (ii) Approval country;
- (iii) Authorized body for the design approval;
- (iv) Design approval number;
- (v) Letters "AA", if the design was approved under alternative arrangements (see 6.7.1.2);
- (d) Pressures
  - (i) Test pressure (in bar gauge);\*
  - (ii) Initial pressure test date (month and year);
  - (iii) Identification mark of the initial pressure test witness;
- (e) Temperatures
  - (i) Design temperature range (in °C);\*
- (f) Elements/Capacity
  - (i) Number of elements;
  - (ii) Total water capacity (in litres);\*
- (g) Periodic inspections and tests
  - (i) Type of the most recent periodic test (5-year or exceptional);
  - (ii) Date of the most recent periodic test (month and year);
  - (iii) Identification mark of the authorized body who performed or witnessed the most recent test.

---

\* The unit used shall be indicated.



Chapter 6.7 – Design, construction, inspection and testing of portable tanks & MEGCs

Figure 6.7.5.13.1 – Example of identification plate marking

Owner's registration number						
<b>MANUFACTURING INFORMATION</b>						
Country of manufacture						
Year of manufacture						
Manufacturer						
Manufacturer's serial number						
<b>APPROVAL INFORMATION</b>						
	Approval country					
	Authorized body for design approval					
	Design approval number				"AA" (if applicable)	
<b>PRESSURES</b>						
Test pressure						bar
Initial pressure test date:		(mm/yyyy)	Witness stamp:			
<b>TEMPERATURES</b>						
Design temperature range						°C to °C
<b>ELEMENTS/CAPACITY</b>						
Number of elements						
Total water capacity						litres
<b>PERIODIC INSPECTIONS/TESTS</b>						
Test type	Test date	Witness stamp	Test type	Test date	Witness stamp	
	(mm/yyyy)			(mm/yyyy)		

6.7.5.13.2 The following information shall be marked on a metal plate firmly secured to the MEGC:

- Name of the operator
- Maximum permissible load mass . . . . . kg
- Working pressure at 15°C: . . . . . bar gauge
- Maximum permissible gross mass (MPGM) . . . . . kg
- Unladen (tare) mass . . . . . kg

## Chapter 6.8

### *Provisions for road tank vehicles*

---

#### 6.8.1 General

##### 6.8.1.1 Tank support frameworks, fitting and tie-down attachments\*

6.8.1.1.1 Road tank vehicles shall be designed and manufactured with supports to provide a secure base during transport and with suitable tie-down attachments. The tie-down attachments shall be located on the tank support or vehicle structure in such a manner that the suspension system is not left in free play.

6.8.1.1.2 Tanks shall be carried only on vehicles whose fastenings are capable, in conditions of maximum permissible loading of the tanks, of absorbing the forces specified in 6.7.2.2.12, 6.7.3.2.9 and 6.7.4.2.12.

#### 6.8.2 Road tank vehicles for long international voyages for substances of classes 3 to 9

##### 6.8.2.1 Design and construction

6.8.2.1.1 A road tank vehicle for long international voyages shall be fitted with a tank complying with the provisions of chapters 4.2 and 6.7 and shall comply with the relevant provisions for tank supports, frameworks, lifting and tie-down attachments,\* except for the provisions for forklift pockets, and in addition comply with the provisions of 6.8.1.1.1.

##### 6.8.2.2 Approval, testing and marking

6.8.2.2.1 For approval, testing and marking of the tank, see 6.7.2.

6.8.2.2.2 The tank supports and tie-down attachments\* of vehicles for long international voyages shall be included in the visual external inspection provided for in 6.7.2.19.

6.8.2.2.3 The vehicle of a road tank vehicle shall be tested and inspected in accordance with the road transport provisions of the competent authority of the country in which the vehicle is operated.

#### 6.8.3 Road tank vehicles for short international voyages

##### 6.8.3.1 Road tank vehicles for substances of classes 3 to 9 (IMO type 4)

###### 6.8.3.1.1 *General provisions*

6.8.3.1.1.1 An IMO type 4 tank shall comply with either:

- .1 the provisions of 6.8.2; or
- .2 the provisions of 6.8.3.1.2 and 6.8.3.1.3.

###### 6.8.3.1.2 *Design and construction*

6.8.3.1.2.1 An IMO type 4 tank shall comply with the provisions of 6.7.2, with the exception of:

- .1 6.7.2.3.2; however, they shall have been subjected to a test pressure not less than that specified according to the appropriate tank instruction assigned to the substance;

---

\* See also IMO Assembly resolution A.581(14) of 20 November 1985, Guidelines for securing arrangements for the transport of road vehicles on ro-ro ships.

- .2 6.7.2.4; however, the thickness of cylindrical portions and ends in reference steel shall be:
    - .1 not more than 2 mm thinner than the thickness specified according to the appropriate tank instruction assigned to the substance;
    - .2 subject to an absolute minimum thickness of 4 mm of reference steel; and
    - .3 for other materials, subject to an absolute minimum thickness of 3 mm;
  - .3 6.7.2.2.13; however, the safety factor shall be not less than 1.3;
  - .4 6.7.2.2.1 to 6.7.2.2.7; however, the materials of construction shall comply with the provisions of the competent authority for road transport;
  - .5 6.7.2.5.1; however, the protection of valves and accessories shall comply with the provisions of the competent authority for road transport;
  - .6 6.7.2.5.3; however, IMO type 4 tanks shall be provided with manholes or other openings in the tank which comply with the provisions of the competent authority for road transport;
  - .7 6.7.2.5.2 and 6.7.2.5.4; however, tank nozzles and external fittings shall comply with the provisions of the competent authority for road transport;
  - .8 6.7.2.6; however, IMO type 4 tanks with bottom openings shall not be used for substances for which bottom openings are not permitted in the appropriate tank instruction assigned to the substance. In addition, existing openings and hand inspection holes shall be either closed by bolted flanges mounted both internally and externally, fitted with product-compatible gaskets, or by welding as specified in 6.7.2.6.1. The closing of openings and hand inspection holes shall be approved by the competent authority for sea transport;
  - .9 6.7.2.7 to 6.7.2.15; however, IMO type 4 tanks shall be fitted with pressure relief devices of the type required according to the appropriate tank instruction assigned to the substance. The devices shall be acceptable to the competent authority for the road transport for the substances to be transported. The start-to-discharge pressure of the spring-loaded pressure relief devices shall in no case be less than the maximum allowable working pressure, nor greater than 25% above that pressure; and
  - .10 6.7.2.17; however, tank supports on permanently attached IMO type 4 tanks shall comply with the provisions of the competent authority for road transport.
- 6.8.3.1.2.2 For IMO type 4 tanks, the maximum effective gauge pressure developed by the substances to be transported shall not exceed the maximum allowable working pressure of the tank.
- 6.8.3.1.3 Approval, testing and marking**
- 6.8.3.1.3.1 IMO type 4 tanks shall be approved for road transport by the competent authority.
- 6.8.3.1.3.2 The competent authority for sea transport shall issue additionally, in respect of an IMO type 4 tank, a certificate attesting compliance with the relevant design, construction and equipment provisions of this subsection and the special provisions for certain substances, as applicable.
- 6.8.3.1.3.3 IMO type 4 tanks shall be periodically tested and inspected in accordance with the provisions of the competent authority for road transport.
- 6.8.3.1.3.4 An IMO type 4 tank shall be marked in accordance with 6.7.2.20. However, where the marking required by the competent authority for road transport is substantially in agreement with that of 6.7.2.20, it will be sufficient to endorse the metal plate attached to the IMO type 4 tank with “IMO 4”.
- 6.8.3.1.3.5 IMO type 4 tanks which are not permanently attached to the chassis shall be marked “IMO type 4” in letters at least 32 mm high.
- 6.8.3.2 Road tank vehicles for non-refrigerated liquefied gases of class 2 (IMO type 6)**
- 6.8.3.2.1 General provisions**
- 6.8.3.2.1.1 An IMO type 6 tank shall comply with either:
- .1 the provisions of 6.7.3; or
  - .2 the provisions of 6.8.3.2.2 and 6.8.3.2.3.
- 6.8.3.2.1.2 For an IMO type 6 tank, the design temperature range is defined in 6.7.3.1. The temperature to be taken is to be agreed by the competent authority for road transport.
- 6.8.3.2.2 Design and construction**
- 6.8.3.2.2.1 An IMO type 6 tank shall comply with the provisions of 6.7.3, with the exception of:
- .1 the safety factor of 1.5 in 6.7.3.2.10; however, the safety factor shall not be less than 1.3;

Part 6 – Construction and testing of packagings, IBCs, etc.

---

- .2 6.7.3.5.7;
  - .3 6.7.3.6.1, if bottom openings are approved by the competent authority for sea transport;
  - .4 6.7.3.7.1; however, the devices shall open at a pressure not less than the MAWP and be fully open at a pressure not exceeding the test pressure of the tank;
  - .5 6.7.3.8, if the delivery capacity of the pressure relief devices is approved by the competent authorities for sea and road transport;
  - .6 the location of the pressure relief device inlets in 6.7.3.11.1, which need not be in the longitudinal centre of the shell;
  - .7 the provisions for forklift pockets; and
  - .8 6.7.3.13.5.
- 6.8.3.2.2.2 If the landing legs of an IMO type 6 tank are to be used as support structure, the loads specified in 6.7.3.2.9 shall be taken into account in their design and method of attachment. Any bending stress induced in the shell as a result of this manner of support shall also be included in the design calculations.
- 6.8.3.2.2.3 Securing arrangements (tie-down attachments) shall be fitted to the tank support structure and the towing vehicle of an IMO type 6 tank. Semi-trailers unaccompanied by a towing vehicle shall be accepted for shipment only if the trailer supports and the securing arrangements and the position of stowage are agreed by the competent authority for sea transport, unless the approved Cargo Securing Manual includes this arrangement.
- 6.8.3.2.3 *Approval, testing and marking*
- 6.8.3.2.3.1 IMO type 6 tanks shall be approved for road transport by the competent authority for road transport.
- 6.8.3.2.3.2 The competent authority for sea transport shall issue additionally, in respect of an IMO type 6 tank, a certificate attesting compliance with the relevant design, construction and equipment provisions of this chapter and, where appropriate, the special provisions for the gases listed in the Dangerous Goods List. The certificate shall list the gases allowed to be transported.
- 6.8.3.2.3.3 An IMO type 6 tank shall be periodically tested and inspected in accordance with the provisions of the competent authority for road transport.
- 6.8.3.2.3.4 An IMO type 6 tank shall be marked in accordance with 6.7.3.16. However, where the marking required by the competent authority for road transport is substantially in agreement with that of 6.7.3.16.1, it will be sufficient to endorse the metal plate attached to the IMO type 6 tank with "IMO 6".
- 6.8.3.3 **Road tank vehicles for refrigerated liquefied gases of class 2 (IMO type 8)**
- 6.8.3.3.1 *General provisions*
- 6.8.3.3.1.1 An IMO type 8 tank shall comply with either:
- .1 the provisions of 6.7.4; or
  - .2 the provisions of 6.8.3.3.2 and 6.8.3.3.3.
- 6.8.3.3.1.2 An IMO type 8 tank shall not be offered for transport by sea in a condition that would lead to venting during the voyage under normal conditions of transport.
- 6.8.3.3.2 *Design and construction*
- 6.8.3.3.2.1 An IMO type 8 tank shall comply with the provisions of 6.7.4, with the exception:
- .1 that aluminium jackets may be used, with the approval of the competent authority for sea transport;
  - .2 that IMO type 8 tanks may have a shell thickness less than 3 mm, subject to the approval of the competent authority for sea transport;
  - .3 that for IMO type 8 tanks used for non-flammable refrigerated gases, one of the valves may be replaced by a frangible disc. The frangible disc shall rupture at a nominal pressure equal to the test pressure;
  - .4 of the provisions of 6.7.4.7.3 for the combined capacity of all pressure relief devices under complete fire-engulfment conditions;
  - .5 of the safety factor of 1.5 in 6.7.4.2.13; however, the safety factor shall not be less than 1.3;
  - .6 of 6.7.4.8; and
  - .7 of the provisions for forklift pockets.
- 6.8.3.3.2.2 If the landing legs of an IMO type 8 tank are to be used as support structure, the loads agreed as in 6.7.4.2.12 shall be taken into account in their design and method of attachment. Bending stress induced in the shell as a result of this manner of support shall be included in design calculations.

- 6.8.3.3.2.3 Securing arrangements (tie-down attachments) shall be fitted to the tank support structure and the towing vehicle of an IMO type 8 tank. Semi-trailers unaccompanied by a towing vehicle shall be accepted for shipment only if the trailer supports and the securing arrangements and the position of stowage are agreed by the competent authority for sea transport, unless the approved Cargo Securing Manual includes this arrangement.
- 6.8.3.3.3 *Approval, testing and marking*
- 6.8.3.3.3.1 IMO type 8 tanks shall be approved for road transport by the competent authority for road transport.
- 6.8.3.3.3.2 The competent authority for sea transport shall issue additionally, in respect of an IMO type 8 tank, a certificate attesting compliance with the relevant design, construction and equipment provisions of this subsection and, where appropriate, the special tank type provisions for the gases in the Dangerous Goods List. The certificate shall list the gases allowed to be transported.
- 6.8.3.3.3.3 IMO type 8 tanks shall be periodically tested and inspected in accordance with the provisions of the competent authority for road transport.
- 6.8.3.3.3.4 IMO type 8 tanks shall be marked in accordance with 6.7.4.15. However, where the marking required by the competent authority for road transport is substantially in agreement with that of 6.7.4.15.1, it will be sufficient to endorse the metal plate attached to the IMO type 8 tank with "IMO 8"; the reference to holding time may be omitted.

## Chapter 6.9

### Provisions for the design, construction, inspection and testing of bulk containers

**Note:** Sheeted bulk containers (BK1) shall not be used for sea transport, except as indicated in 4.3.3.

#### 6.9.1 Definitions

For the purposes of this section:

*Closed bulk container* means a totally closed bulk container having a rigid roof, sidewalls, end walls and floor (including hopper-type bottoms), including bulk containers with an opening roof, or side or end wall that can be closed during transport. Closed bulk container may be equipped with openings to allow for the exchange of vapours and gases with air and which prevent, under normal conditions of transport, the release of solid contents as well as the penetration of rain and splash water.

*Flexible bulk container* means a flexible container with a capacity not exceeding 15 m<sup>3</sup> and includes liners and attached handling devices and service equipment.

*Sheeted bulk container* means an open-top bulk container with rigid bottom (including hopper-type bottom), side and end walls and a non-rigid covering.

#### 6.9.2 Application and general provisions

6.9.2.1 Bulk containers and their service and structural equipment shall be designed and constructed to withstand, without loss of contents, the internal pressure of the contents and the stresses of normal handling and transport.

6.9.2.2 Where a discharge valve is fitted, it shall be capable of being made secure in the closed position and the whole discharge system shall be suitably protected from damage. Valves having lever closures shall be able to be secured against unintended opening and the open or closed position shall be readily apparent.

#### 6.9.2.3 Code for designating types of bulk container

The following table indicates the codes to be used for designating types of bulk containers:

Types of bulk container	Code
Sheeted bulk container	BK1
Closed bulk container	BK2
Flexible bulk container	BK3

6.9.2.4 In order to take account of progress in science and technology, the use of alternative arrangements which offer at least equivalent safety as provided by the provisions of this chapter may be considered by the competent authority.

#### 6.9.3 Provisions for the design, construction, inspection and testing of freight containers used as BK1 or BK2 bulk containers

##### 6.9.3.1 Design and construction provisions

6.9.3.1.1 The general design and construction provisions in this section are deemed to be met if the bulk container complies with the requirements of ISO 1496-4:1991 "Series 1 freight containers – Specification and testing – Part 4: Non-pressurized containers for dry bulk" and the container is siftproof.

6.9.3.1.2 Freight containers designed and tested in accordance with ISO 1496-1:1990 "Series 1 freight containers – Specification and testing – Part 1: General cargo containers for general purposes" shall be equipped with

operational equipment which is, including its connection to the freight container, designed to strengthen the end walls and to improve the longitudinal restraint as necessary to comply with the test requirements of ISO 1496-4:1991, as relevant.

**6.9.3.1.3** Bulk containers shall be siftproof. Where a liner is used to make the container siftproof, it shall be made of a suitable material. The strength of the material used for, and the construction of, the liner shall be appropriate to the capacity of the container and its intended use. Joins and closures of the liner shall withstand pressures and impacts liable to occur under normal conditions of handling and transport. For ventilated bulk containers, any liner shall not impair the operation of ventilating devices.

**6.9.3.1.4** The operational equipment of bulk containers designed to be emptied by tilting shall be capable of withstanding the total filling mass in the tilted orientation.

**6.9.3.1.5** Any movable roof or side or end wall or roof section shall be fitted with locking devices with securing devices designed to show the locked state to an observer at ground level.

**6.9.3.2 Service equipment**

**6.9.3.2.1** Filling and discharge devices shall be so constructed and arranged as to be protected against the risk of being wrenched off or damaged during transport and handling. The filling and discharge devices shall be capable of being secured against unintended opening. The open and closed position and direction of closure shall be clearly indicated.

**6.9.3.2.2** Seals of openings shall be so arranged as to avoid any damage by the operation, filling and emptying of the bulk container.

**6.9.3.2.3** Where ventilation is required, bulk containers shall be equipped with means of air exchange, either by natural convection, e.g., by openings, or active elements, e.g., fans. The ventilation shall be designed to prevent negative pressures in the container at all times. Ventilating elements of bulk containers for the transport of flammable substances or substances emitting flammable gases or vapours shall be designed so as not to be a source of ignition.

**6.9.3.3 Inspection and testing**

**6.9.3.3.1** Freight containers used, maintained and qualified as bulk containers in accordance with the requirements of this section shall be tested and approved in accordance with the International Convention for Safe Containers (CSC), 1972, as amended.

**6.9.3.3.2** Freight containers used and qualified as bulk containers shall be inspected periodically according to that Convention.

**6.9.3.4 Marking**

**6.9.3.4.1** Freight containers used as bulk containers shall be marked with a Safety Approval Plate in accordance with the International Convention for Safe Containers.

**6.9.4 Provisions for the design, construction and approval of BK1 or BK2 bulk containers other than freight containers**

**6.9.4.1** Bulk containers covered in this section include skips, offshore bulk containers, bulk bins, swap bodies, trough-shaped containers, roller containers, and load compartments of vehicles.

**6.9.4.2** These bulk containers shall be designed and constructed so as to be strong enough to withstand the shocks and loadings normally encountered during transport, including, as applicable, transhipment between modes of transport.

**6.9.4.3** Load compartments of vehicles shall comply with the requirements of, and be acceptable to, the competent authority responsible for land transport of the dangerous goods to be transported in bulk.

**6.9.4.4** These bulk containers shall be approved by the competent authority and the approval shall include the code for designating types of bulk containers in accordance with 6.9.2.3 and the provisions for inspection and testing, as appropriate.

**6.9.4.5** Where it is necessary to use a liner in order to retain the dangerous goods, it shall meet the provisions of 6.9.3.1.3.

6.9.4.6 The following statement shall be shown on the transport document:  
“Bulk container BK(x)<sup>\*</sup> approved by the competent authority of ...”.

### **6.9.5 Requirements for the design, construction, inspection and testing of flexible bulk containers BK3**

#### **6.9.5.1 Design and construction requirements**

6.9.5.1.1 Flexible bulk containers shall be sift-proof.

6.9.5.1.2 Flexible bulk containers shall be completely closed to prevent the release of contents.

6.9.5.1.3 Flexible bulk containers shall be waterproof.

6.9.5.1.4 Parts of the flexible bulk container which are in direct contact with dangerous goods:

- (a) Shall not be affected or significantly weakened by those dangerous goods;
- (b) Shall not cause a dangerous effect, e.g., catalysing a reaction or reacting with the dangerous goods; and
- (c) Shall not allow permeation of the dangerous goods that could constitute a danger under normal conditions of transport.

#### **6.9.5.2 Service equipment and handling devices**

6.9.5.2.1 Filling and discharge devices shall be so constructed as to be protected against damage during transport and handling. The filling and discharge devices shall be capable of being secured against unintended opening.

6.9.5.2.2 Slings of the flexible bulk container, if fitted, shall withstand pressure and dynamic forces which can appear in normal conditions of handling and transport.

6.9.5.2.3 The handling devices shall be strong enough to withstand repeated use.

#### **6.9.5.3 Inspection and testing**

6.9.5.3.1 Each flexible bulk container design type shall successfully pass the tests prescribed in this Chapter before being used.

6.9.5.3.2 Tests shall also be repeated after each modification of design type which alters the design, material or manner of construction of a flexible bulk container.

6.9.5.3.3 Tests shall be carried out on flexible bulk containers prepared as for transport. Flexible bulk containers shall be filled to the maximum mass at which they may be used and the contents shall be evenly distributed. The substances to be transported in the flexible bulk container may be replaced by other substances except where this would invalidate the results of the tests. When another substance is used it shall have the same physical characteristics (mass, grain size, etc.) as the substance to be transported. It is permissible to use additives, such as bags of lead shot, to achieve the requisite total mass of the flexible bulk container, so long as they are placed so that the test results are not affected.

6.9.5.3.4 Flexible bulk containers shall be manufactured and tested under a quality assurance programme which satisfies the competent authority, in order to ensure that each manufactured flexible bulk container meets the requirements of this Chapter.

#### **6.9.5.3.5 Drop test**

##### **6.9.5.3.5.1 Applicability**

For all types of flexible bulk containers, as a design type test.

##### **6.9.5.3.5.2 Preparation for testing**

The flexible bulk container shall be filled to its maximum permissible gross mass.

6.9.5.3.5.3 The flexible bulk container shall be dropped onto a target surface that is non-resilient and horizontal. The target surface shall be:

- (a) Integral and massive enough to be immovable;
- (b) Flat with a surface kept free from local defects capable of influencing the test results;

---

\* “(x)” should be replaced with “1” or “2” as appropriate.



- (c) Rigid enough to be non-deformable under test conditions and not liable to become damaged by the tests; and
- (d) Sufficiently large to ensure that the test flexible bulk container falls entirely upon the surface.

Following the drop, the flexible bulk container shall be restored to the upright position for observation.

**6.9.5.3.5.4** Drop height shall be:

Packing group III: 0.8 m

**6.9.5.3.5.5** Criteria for passing the test:

- (a) There shall be no loss of contents. A slight discharge, e.g., from closures or stitch holes, upon impact shall not be considered to be a failure of the flexible bulk container provided that no further leakage occurs after the container has been restored to the upright position;
- (b) There shall be no damage which renders the flexible bulk container unsafe to be transported for salvage or for disposal.

**6.9.5.3.6** *Top lift test*

**6.9.5.3.6.1** *Applicability*

For all types of flexible bulk containers as a design type test.

**6.9.5.3.6.2** *Preparation for testing*

Flexible bulk containers shall be filled to six times the maximum net mass, the load being evenly distributed.

**6.9.5.3.6.3** A flexible bulk container shall be lifted in the manner for which it is designed until clear of the floor and maintained in that position for a period of five minutes.

**6.9.5.3.6.4** Criteria for passing the test: there shall be no damage to the flexible bulk container or its lifting devices which renders the flexible bulk container unsafe for transport or handling, and no loss of contents.

**6.9.5.3.7** *Topple test*

**6.9.5.3.7.1** *Applicability*

For all types of flexible bulk containers as a design type test.

**6.9.5.3.7.2** *Preparation for testing*

The flexible bulk container shall be filled to its maximum permissible gross mass.

**6.9.5.3.7.3** Flexible bulk container shall be toppled onto any part of its top by lifting the side furthest from the drop edge upon a target surface that is non-resilient and horizontal. The target surface shall be:

- (a) Integral and massive enough to be immovable;
- (b) Flat with a surface kept free from local defects capable of influencing the test results;
- (c) Rigid enough to be non-deformable under test conditions and not liable to become damaged by the tests; and
- (d) Sufficiently large to ensure that the test flexible bulk container falls entirely upon the surface.

**6.9.5.3.7.4** For all flexible bulk containers, the topple height is specified as follows:

Packing group III: 0.8 m

**6.9.5.3.7.5** Criterion for passing the test: there shall be no loss of contents. A slight discharge, e.g., from closures or stitch holes, upon impact shall not be considered to be a failure of the flexible bulk container provided that no further leakage occurs.

**6.9.5.3.8** *Righting test*

**6.9.5.3.8.1** *Applicability*

For all types of flexible bulk containers designed to be lifted from the top or side, as a design type test.

**6.9.5.3.8.2** *Preparation for testing*

The flexible bulk container shall be filled to not less than 95% of its capacity and to its maximum permissible gross mass.

**6.9.5.3.8.3** The flexible bulk container, lying on its side, shall be lifted at a speed of at least 0.1 m/s to an upright position, clear of the floor, by no more than half of the lifting devices.

Part 6 – Construction and testing of packagings, IBCs, etc.

---

6.9.5.3.8.4 Criterion for passing the test: there shall be no damage to the flexible bulk container or its lifting devices which renders the flexible bulk container unsafe for transport or handling.

6.9.5.3.9 **Tear test**

6.9.5.3.9.1 *Applicability*

For all types of flexible bulk containers as a design type test.

6.9.5.3.9.2 *Preparation for testing*

The flexible bulk container shall be filled to its maximum permissible gross mass.

6.9.5.3.9.3 With the flexible bulk container placed on the ground, a 300 mm cut shall be made, completely penetrating all layers of the flexible bulk container on a wall of a wide face. The cut shall be made at a 45° angle to the principal axis of the flexible bulk container, halfway between the bottom surface and the top level of the contents. The flexible bulk container shall then be subjected to a uniformly distributed superimposed load equivalent to twice the maximum gross mass. The load must be applied for at least fifteen minutes. A flexible bulk container which is designed to be lifted from the top or the side shall, after removal of the superimposed load, be lifted clear of the floor and maintained in that position for a period of fifteen minutes.

6.9.5.3.9.4 Criterion for passing the test: the cut shall not propagate more than 25% of its original length.

6.9.5.3.10 **Stacking test**

6.9.5.3.10.1 *Applicability*

For all types of flexible bulk containers as a design type test.

6.9.5.3.10.2 *Preparation for testing*

The flexible bulk container shall be filled to its maximum permissible gross mass.

6.9.5.3.10.3 The flexible bulk container shall be subjected to a force applied to its top surface that is four times the design load-carrying capacity for 24 hours.

6.9.5.3.10.4 Criterion for passing the test: there shall be no loss of contents during the test or after removal of the load.

6.9.5.4 **Test report**

6.9.5.4.1 A test report containing at least the following particulars shall be drawn up and shall be available to the users of the flexible bulk container:

1. Name and address of the test facility;
2. Name and address of applicant (where appropriate);
3. Unique test report identification;
4. Date of the test report;
5. Manufacturer of the flexible bulk container;
6. Description of the flexible bulk container design type (e.g., dimensions, materials, closures, thickness, etc.) and/or photograph(s);
7. Maximum capacity/maximum permissible gross mass;
8. Characteristics of test contents, e.g., particle size for solids;
9. Test descriptions and results;
10. The test report shall be signed with the name and status of the signatory.

6.9.5.4.2 The test report shall contain statements that the flexible bulk container prepared as for transport was tested in accordance with the appropriate provisions of this Chapter and that the use of other containment methods or components may render it invalid. A copy of the test report shall be available to the competent authority.

6.9.5.5 **Marking**

6.9.5.5.1 Each flexible bulk container manufactured and intended for use according to these provisions shall bear markings that are durable, legible and placed in a location so as to be readily visible. Letters, numerals and symbols shall be at least 24 mm high and shall show:

- (a) The United Nations packaging symbol 

This symbol shall not be used for any purpose other than certifying that a packaging, a flexible bulk container, a portable tank or a MEGC complies with the relevant requirements in Chapter 6.1, 6.2, 6.3, 6.5, 6.6, 6.7 or 6.9;

- (b) The code BK3;
- (c) A capital letter designating the packing group(s) for which the design type has been approved:  
Z for packing group III only;
- (d) The month and year (last two digits) of manufacture;
- (e) The character(s) identifying the country authorizing the allocation of the mark; as indicated by the distinguishing sign for motor vehicles in international traffic;
- (f) The name or symbol of the manufacturer and other identification of the flexible bulk container as specified by the competent authority;
- (g) The stacking test load in kg;
- (h) The maximum permissible gross mass in kg.

**Marking** shall be applied in the sequence shown in (a) to (h); each element of the marking, required in these subparagraphs, shall be clearly separated, e.g., by a slash or space and presented in a way that ensures that all of the parts of the mark are easily identified.

#### 6.9.5.5.2 Example of marking



BK3/Z/11 09  
RUS/NTT/MK-14-10  
56000/14000





PART 7

PROVISIONS CONCERNING  
TRANSPORT OPERATIONS



## Chapter 7.1

### General stowage provisions

---

#### 7.1.1 Introduction

This chapter contains the general provisions for the stowage of dangerous goods in all types of ships. Specific provisions applicable to, container ships, ro-ro ships, general cargo ships and barge carrying ships, are stipulated in chapters 7.4 to 7.7.

#### 7.1.2 Definitions

**Note:** The term “magazine” is no longer used in the context of the IMDG Code. A magazine that is not a fixed part of the ship shall meet the provisions for a closed cargo transport unit for class 1 (see 7.1.2). A magazine that is a fixed part of the ship such as compartment, below deck area or hold shall meet the provisions of 7.6.2.4.

*Clear of living quarters* means that packages or cargo transport units shall be stowed in a minimum distance of 3 m from accommodation, air intakes, machinery spaces and other enclosed work areas.

*Closed cargo transport unit for class 1* means a unit which fully encloses the contents by permanent structures, can be secured to the ship's structure and is, except for division 1.4, structurally serviceable as defined in this section. Cargo transport units with fabric sides or tops are not closed cargo transport units. The floor of any closed cargo transport unit shall either be constructed of wood, close-boarded, or so arranged that goods are stowed on sparred gratings, wooden pallets or dunnage.

Combustible material means material which may or may not be dangerous goods but which is easily ignited and supports combustion. Examples of combustible materials include wood, paper, straw, vegetable fibres, products made from such materials, coal, lubricants, and oils. This definition does not apply to packaging material or dunnage.

*Potential sources of ignition* means, but is not limited to, open fires, machinery exhausts, galley uptakes, electrical outlets and electrical equipment including those on refrigerated or heated cargo transport units unless they are of certified safe type\*.

*Protected from sources of heat* means that packages and cargo transport units shall be stowed at least 2.4 m from heated ship structures, where the surface temperature is liable to exceed 55°C. Examples of heated structures are steam pipes, heating coils, top or side walls of heated fuel and cargo tanks, and bulkheads of machinery spaces. In addition, packages not loaded inside a cargo transport unit and stowed on deck shall be shaded from direct sunlight. The surface of a cargo transport unit can heat rapidly when in direct sunlight in nearly windless conditions and the cargo may also become heated. Depending on the nature of the goods in the cargo transport unit and the planned voyage precautions shall be taken to ensure that exposure to direct sunlight is reduced.

*Stowage* means the proper placement of dangerous goods on board a ship in order to ensure safety and environmental protection during transport.

*Stowage on deck* means stowage on the weather deck. For open ro-ro cargo spaces see 7.5.2.6.

*Stowage under deck* means any stowage that is not on the weather deck. For hatchless containerships see 7.4.2.1.

*Structurally serviceable for class 1* means, the cargo transport unit shall not have major defects in its structural components, e.g. top and bottom rails, top and bottom end rails, door sill and header, floor cross-members, corner posts, and corner fittings in a freight container. Major defects are: dents or bends in the structural members greater than 19 mm in depth, regardless of length; cracks or breaks in structural members; more

---

\* For cargo spaces, refer to SOLAS II-2/19.3.2 and for refrigerated or heated cargo transport units refer to Recommendation published by the international Electrotechnical Commission, in particular IEC 60079.

**Part 7 – Provisions concerning transport operations**

than one splice (e.g. a lapped splice) in top or bottom end rails or door headers; more than two splices in any one top or bottom side rail or any splice in a door sill or corner post; door hinges and hardware that are seized, twisted, broken, missing or otherwise inoperative; gaskets and seals that do not seal; or, for freight containers, any distortion of the overall configuration great enough to prevent proper alignment of handling equipment, mounting and securing on chassis or vehicle, or insertion into ship's cells. In addition, deterioration in any component of the cargo transport unit, regardless of the material of construction, such as rusted-out metal in sidewalls or disintegrated fiberglass, is unacceptable. Normal wear, however, including oxidation (rust), slight dents and scratches and other damage that does not affect serviceability or the weathertight integrity of the units, is acceptable.

**7.1.3 Stowage categories**

**7.1.3.1 Stowage categories for class 1**

Dangerous goods of class 1 other than division 1.4 compatibility group S, packed in limited quantities shall be stowed as indicated in column 16 of the Dangerous Goods List in accordance with one of the categories specified below.

<b>Stowage category 01</b>	Cargo ships	On deck in closed cargo transport unit or under deck
	(up to 12 passengers)	
	Passenger ships	On deck in closed cargo transport unit or under deck
<b>Stowage category 02</b>	Cargo ships	On deck in closed cargo transport unit or under deck
	(up to 12 passengers)	
	Passenger ships	On deck in closed cargo transport unit or under deck in closed cargo transport unit in accordance with 7.1.4.4.5
<b>Stowage category 03</b>	Cargo ships	On deck in closed cargo transport unit or under deck
	(up to 12 passengers)	
	Passenger ships	Prohibited except if in accordance with 7.1.4.4.5
<b>Stowage category 04</b>	Cargo ships	On deck in closed cargo transport unit or under deck in closed cargo transport unit
	(up to 12 passengers)	
	Passenger ships	Prohibited except if in accordance with 7.1.4.4.5
<b>Stowage category 05</b>	Cargo ships	On deck only in closed cargo transport unit
	(up to 12 passengers)	
	Passenger ships	Prohibited except if in accordance with 7.1.4.4.5

**7.1.3.2 Stowage categories for classes 2 to 9**

Dangerous goods of classes 2 to 9 and division 1.4 compatibility group S, packed in limited quantities shall be stowed as indicated in column 16 of the Dangerous Goods List in accordance with one of the categories specified below:

<b>Stowage category A</b>	
Cargo ships or passenger ships carrying a number of passengers limited to not more than 25 or to 1 passenger per 3 m of overall length, whichever is the greater number	} ON DECK OR UNDER DECK
Other passenger ships in which the limiting number of passengers transported is exceeded	
<b>Stowage category B</b>	
Cargo ships or passenger ships carrying a number of passengers limited to not more than 25 or to 1 passenger per 3 m of overall length, whichever is the greater number	} ON DECK OR UNDER DECK
Other passenger ships in which the limiting number of passengers transported is exceeded	
	} ON DECK ONLY



**Stowage category C**

Cargo ships or passenger ships carrying a number of passengers limited to not more than 25 or to 1 passenger per 3 m of overall length, whichever is the greater number	}	ON DECK ONLY
Other passenger ships in which the limiting number of passengers transported is exceeded		ON DECK ONLY

**Stowage category D**

Cargo ships or passenger ships carrying a number of passengers limited to not more than 25 or to 1 passenger per 3 m of overall length, whichever is the greater number	}	ON DECK ONLY
Other passenger ships in which the limiting number of passengers transported is exceeded		PROHIBITED

**Stowage category E**

Cargo ships or passenger ships carrying a number of passengers limited to not more than 25 or to 1 passenger per 3 m of overall length, whichever is the greater number	}	ON DECK OR UNDER DECK
Other passenger ships in which the limiting number of passengers transported is exceeded		PROHIBITED

**7.1.4 Special stowage provisions**

**7.1.4.1 Stowage of empty uncleaned packagings, including IBCs and large packagings.**

Notwithstanding the stowage provisions given in the Dangerous Goods List, empty uncleaned packagings, including IBCs and large packagings, which shall be stowed on deck only when full may be stowed on deck or under deck in a mechanically ventilated cargo space. However, empty uncleaned pressure receptacles which carry a label of class 2.3 shall be stowed on deck only (see also 4.1.1.11) and waste aerosols shall only be stowed according to column (16) of the Dangerous Goods List.

**7.1.4.2 Stowage of marine pollutants**

Where stowage is permitted on deck or under deck, under deck stowage is preferred. Where stowage on deck only is required, preference shall be given to stowage on well-protected decks or to stowage inboard in sheltered areas of exposed decks.

**7.1.4.3 Stowage of limited quantities and excepted quantities**

For the stowage of limited quantities and excepted quantities see sections 3.4 and 3.5.

**7.1.4.4 Stowage of goods of class 1**

**7.1.4.4.1** In cargo ships of 500 gross tons or over and passenger ships constructed before 1 September 1984 and in cargo ships of less than 500 gross tons constructed before 1 February 1992, goods of class 1 with the exception of division 1.4, compatibility group S, shall be stowed on deck only, unless otherwise approved by the Administration.

**7.1.4.4.2** Goods of class 1 with the exception of division 1.4 shall be stowed not less than a horizontal distance of 12m from living quarters, life-saving appliances and areas with public access.

**7.1.4.4.3** Goods of class 1 with the exception of division 1.4 shall be not be positioned closer to the ship's side than a distance equal to one eighth of the beam or 2.4 m, whichever is the lesser.

**7.1.4.4.4** Goods of class 1 shall not be stowed within a horizontal distance of 6 m from potential sources of ignition.

**7.1.4.4.5** Stowage on passenger ships

**7.1.4.4.5.1** Goods in division 1.4, compatibility group S, may be transported in any amount on passenger ships. No other goods of class 1 may be transported on passenger ships except:

- .1 goods in compatibility groups C, D and E and articles in compatibility group G, if the total net explosive mass does not exceed 10 kg per ship and if they are transported in closed cargo transport units on deck or under deck ;
- .2 articles in compatibility group B, if the total net explosive mass does not exceed 10 kg per ship and if they are transported on deck only in closed cargo transport units.

**7.1.4.4.6** Alternative arrangements to those prescribed in Chapter 7.1 for class 1 may be approved by the Administration.

Part 7 – Provisions concerning transport operations

7.1.4.5 Stowage of goods of class 7

7.1.4.5.1 The total activity in a single cargo space of a sea going vessel for transport of LSA material or SCO in Type IP 1, Type IP 2, Type IP 3 packaging or unpackaged shall not exceed the limits shown in the table hereunder.

Conveyance activity limits for LSA material and SCO  
in industrial packages or unpackaged

Nature of material	Activity limit for a seagoing vessel
LSA I	No limit
LSA II and LSA III non combustible solids	No limit
LSA II and LSA III combustible solids, and all liquids and gases	100A <sub>2</sub>
SCO	100A <sub>2</sub>

7.1.4.5.2 Provided that its average surface heat flux does not exceed 15 W/m<sup>2</sup> and that the immediately surrounding cargo is not in sacks or bags, a package or overpack may be transported or stored among packaged general cargo without any special stowage provisions except as may be specifically required by the competent authority in an applicable approval certificate.

7.1.4.5.3 Loading of freight containers and accumulation of packages, overpacks and freight containers shall be controlled as follows:

- .1 Except under the condition of exclusive use, the total number of packages, overpacks and freight containers aboard a single conveyance shall be so limited that the total sum of the transport indexes aboard the conveyance does not exceed the values shown in the table hereunder. For consignments of LSA I material there shall be no limit on the sum of the transport indexes.

TI limits for freight containers and conveyances not under exclusive use

Type of freight container or conveyance	Limit on total sum of transport indexes in a freight container or aboard a conveyance
Freight container – small	50
Freight container – large	50
Vehicle	50
Inland water-way vessel (barge)	50
Seagoing vessel <sup>a</sup>	
1 Hold, compartment or defined area Packages, overpacks, small freight containers	50
Large freight containers (closed containers)	200

Type of freight container or conveyance	Limit on total sum of transport indexes in a freight container or aboard a conveyance
2 Total vessel Packages, overpacks, small freight containers	200
Large freight containers (closed containers)	No limit

<sup>a</sup> Packages or overpacks transported in or on a vehicle which are in accordance with the provisions of 7.1.4.5.6 may be transported by vessels provided that they are not removed from the vehicle at any time while on board the ship.

- .2 Where a consignment is transported under exclusive use, there shall be no limit on the sum of the transport indexes aboard a single conveyance.
- .3 The radiation level under routine conditions of transport shall not exceed 2 mSv/h at any point on, and 0.1 mSv/h at 2 m from, the external surface of the conveyance, except for consignments transported under exclusive use by road or rail, for which the radiation limits around the vehicle are specified in 7.1.4.5.6.2 and 7.1.4.5.6.3.

- .4 The total sum of the criticality safety indexes in a freight container and aboard a conveyance shall not exceed the values shown in the table hereunder.

**CSI limits for freight containers and conveyances containing fissile material**

Type of freight container or conveyance	Limit on total sum of criticality safety indexes in a freight container or aboard a conveyance	
	Not under exclusive use	Under exclusive use
Freight container small	50	n.a.
Freight container large	50	100
Vehicle	50	100
Inland water-way vessel (barge)	50	100
Seagoing vessel <sup>a</sup>		
1 Cargo space or defined deck area		
Packages, overpacks, small freight containers	50	100
Large freight containers (closed containers)	50	100

Type of freight container or conveyance	Limit on total sum of criticality safety indexes in a freight container or aboard a conveyance	
	Not under exclusive use	Under exclusive use
2 Total vessel		
Packages, overpacks, small freight containers	200 <sup>b</sup>	200 <sup>c</sup>
Large freight containers (closed containers)	No limit <sup>b</sup>	No limit <sup>c</sup>

<sup>a</sup> Packages or overpacks transported in or on a vehicle which are in accordance with the provisions of 7.1.4.5.5 may be transported by ships provided that they are not removed from the vehicle at any time while on board the ship. In that case, the entries under the heading "under exclusive use" apply.

<sup>b</sup> The consignment shall be so handled and stowed that the total sum of CSIs in any group does not exceed 50, and that each group is handled and stowed so that the groups are separated from each other by at least 6 m.

<sup>c</sup> The consignment shall be so handled and stowed that the total sum of CSIs in any group does not exceed 100, and that each group is handled and stowed so that the groups are separated from each other by at least 6 m. The intervening space between groups may be occupied by other cargo.

7.1.4.5.4 Any package or overpack having either a transport index greater than 10, or any consignment having a criticality safety index greater than 50, shall be transported only under exclusive use.

7.1.4.5.5 For consignments under exclusive use, the radiation level shall not exceed:

- .1 10 mSv/h at any point on the external surface of any package or overpack, and may only exceed 2 mSv/h provided that:
  - .1 the vehicle is equipped with an enclosure which, during routine conditions of transport, prevents the access of unauthorized persons to the interior of the enclosure, and
  - .2 provisions are made to secure the package or overpack so that its position within the vehicle enclosure remains fixed during routine conditions of transport, and
  - .3 there is no loading or unloading during the shipment;
- .2 2 mSv/h at any point on the outer surfaces of the vehicle, including the upper and lower surfaces, or, in the case of an open vehicle, at any point on the vertical planes projected from the outer edges of the vehicle, on the upper surface of the load, and on the lower external surface of the vehicle; and
- .3 0.1 mSv/h at any point 2 m from the vertical planes represented by the outer lateral surfaces of the vehicle, or, if the load is transported in an open vehicle, at any point 2 m from the vertical planes projected from the outer edges of the vehicle.

## Part 7 – Provisions concerning transport operations

- 7.1.4.5.6 In the case of road vehicles, no persons other than the driver and assistants shall be permitted in vehicles carrying packages, overpacks or freight containers bearing category II YELLOW or III YELLOW labels.
- 7.1.4.5.7 Packages or overpacks having a surface radiation level greater than 2 mSv/h, unless being transported in or on a vehicle under exclusive use in accordance with the table under 7.1.4.5.3, footnote (a), shall not be transported by ship except under special arrangement.
- 7.1.4.5.8 The transport of consignments by means of a special use ship which, by virtue of its design or by reason of its being chartered, is dedicated to the purpose of carrying radioactive material shall be excepted from the provisions specified in 7.1.4.5.3 provided that the following conditions are met:
- .1 a radiation protection programme for the shipment shall be approved by the Administration and, when requested, by the competent authority at each port of call;
  - .2 stowage arrangements shall be predetermined for the whole voyage, including any consignments to be loaded at ports of call en route; and
  - .3 the loading, transport and unloading of the consignments shall be supervised by persons qualified in the transport of radioactive material.
- 7.1.4.5.9 Any conveyance and equipment used regularly for the transport of radioactive material shall be periodically checked to determine the level of contamination. The frequency of such checks shall be related to the likelihood of contamination and the extent to which radioactive material is transported.
- 7.1.4.5.10 Except as provided in 7.1.4.5.11, any conveyance, or equipment or part thereof, which has become contaminated above the limits specified in 4.1.9.1.2 in the course of the transport of radioactive material, or which shows a radiation level in excess of 5 µSv/h at the surface, shall be decontaminated as soon as possible by a qualified person and shall not be re used unless the non fixed contamination does not exceed the limits specified in 4.1.9.1.2, and the radiation level resulting from the fixed contamination on surfaces after decontamination is less than 5 µSv/h at the surface.
- 7.1.4.5.11 A freight container, tank, IBC or conveyance dedicated to the transport of unpackaged radioactive material under exclusive use shall be excepted from the provisions of 4.1.9.1.4 and 7.1.4.5.10 solely with regard to its internal surfaces and only for as long as it remains under that specific exclusive use.
- 7.1.4.5.12 Where a consignment is undeliverable, the consignment shall be placed in a safe location and the appropriate competent authority shall be informed as soon as possible and a request made for instructions on further action.
- 7.1.4.5.13 Radioactive material shall be segregated sufficiently from crew and passengers. The following values for dose shall be used for the purpose of calculating segregation distances or radiation levels:
- .1 for crew in regularly occupied working areas, a dose of 5 mSv in a year;
  - .2 for passengers, in areas where the passengers have regular access, a dose of 1 mSv in a year to the critical group, taking account of the exposures expected to be delivered by all other relevant sources and practices under control.
- 7.1.4.5.14 Category II YELLOW or III YELLOW packages or overpacks shall not be transported in spaces occupied by passengers, except those exclusively reserved for couriers specially authorized to accompany such packages or overpacks.
- 7.1.4.5.15 Any group of packages, overpacks and freight containers containing fissile material stored in transit in any one storage area shall be so limited that the total sum of the criticality safety indexes in the group does not exceed 50. Each group shall be stored so as to maintain a spacing of at least 6 m from other such groups.
- 7.1.4.5.16 Where the total sum of the criticality safety indexes on board a conveyance or in a freight container exceeds 50, as permitted in the table under 7.1.4.5.3.4, storage shall be such as to maintain a spacing of at least 6 m from other groups of packages, overpacks or freight containers containing fissile material or other conveyances carrying radioactive material.
- 7.1.4.5.17 Any departure from the provisions in 7.1.4.5.15 and 7.1.4.5.16 shall be approved by Administration and, when requested, by the competent authority at each port of call.
- 7.1.4.5.18 The segregation requirements specified in 7.1.4.5.13 may be established in one of the following two ways:
- by following the segregation table for persons (table 1 hereafter) in respect of living quarters or spaces regularly occupied by persons.
  - by demonstration that, for the following indicated exposure times, the direct measurement of the radiation level in regularly occupied spaces and living quarters is less than:
 

*for the crew:*

0.0070 mSv/h up to 700 hours in a year, or

0.0018 mSv/h up to 2750 hours in a year; and

for the passengers:

0.0018 mSv/h up to 550 hours in a year,

taking into account any relocation of cargo during the voyage. In all cases, the measurements of radiation level must be made and documented by a suitably qualified person.

Table 1 – CLASS 7 – Radioactive material  
Segregation table for persons

Sum of transport indices (TI)	Segregation distance of radioactive material from passengers and crew			
	General cargo ship <sup>1</sup>		Ferry, etc. <sup>2</sup>	Offshore support vessel <sup>3</sup>
	Break bulk (metres)	Containers (TEUs) <sup>4</sup>		
Up to 10	6	1	Stow at bow or stern furthest from living quarters and regularly occupied work areas	Stow at stern or at platform midpoint
More than 10 but not more than 20	8	1	as above	as above
More than 20 but not more than 50	13	2	as above	not applicable
More than 50 but not more than 100	18	3	as above	not applicable
More than 100 but not more than 200	26	4	as above	not applicable
More than 200 but not more than 400	36	6	as above	not applicable

<sup>1</sup> General cargo, break bulk or ro ro containership of 150 m minimum length.

<sup>2</sup> Ferry or cross channel, coastal and inter island ship of 100 m minimum length.

<sup>3</sup> Offshore support vessel of 50 m minimum length. (In this case the practical maximum sum of TIs carried is 20).

<sup>4</sup> TEU means "20 ft Equivalent Unit" (this is equivalent to a standard freight container of 6 m nominal length).

#### 7.1.4.6 Stowage of dangerous goods under temperature control

##### 7.1.4.6.1

When stowage arrangements are made, it shall be borne in mind that it may become necessary to take the appropriate emergency action, such as jettisoning or flooding of the container with water and the temperature need to be monitored in accordance to 7.3.7. If, during transport, the control temperature is exceeded, an alerting procedure shall be initiated involving either repair of the refrigeration machinery or an increase in the cooling capacity (such as by adding liquid or solid refrigerants). If an adequate cooling capacity is not restored, emergency procedures shall be started.

## Chapter 7.2

---

### *General segregation provisions*

#### 7.2.1 Introduction

This chapter contains the general provisions for the segregation of goods which are mutually incompatible.

Additional segregation provisions are given in:

- 7.3 Consigning operations concerning the packing and use of cargo transport units (CTUs) and related provisions;
- 7.4 Stowage and segregation on containerships;
- 7.5 Stowage and segregation on roll-on/roll-off ships;
- 7.6 Stowage and segregation on general cargo ships; and
- 7.7 Shipborne barges on barge-carrying ships.

#### 7.2.2 Definitions

##### 7.2.2.1 Segregation

Segregation is the process of separating two or more substances or articles which are considered mutually incompatible when their packing or stowage together may result in undue hazards in case of leakage or spillage, or any other accident.

However, as the extent of the hazard arising may vary, the segregation arrangements required may also vary as appropriate. Segregation is obtained by maintaining certain distances between incompatible dangerous goods or by requiring the presence of one or more steel bulkheads or decks between them, or a combination thereof. Intervening spaces between such dangerous goods may be filled with other cargo compatible with the dangerous substances or articles in question.

##### 7.2.2.2 Segregation terms

The following segregation terms that are used throughout this Code are defined in other chapters of this part as they apply to packing cargo transport units and segregation on board different ship types:

- .1 "Away from";
- .2 "Separated from";
- .3 "Separated by a complete compartment or hold from";
- .4 "Separated longitudinally by an intervening complete compartment or hold from".

Segregation terms such as "away from class ..." that are used in the Dangerous Goods List, "class ..." is deemed to include:

- .1 all substances within "class ..."; and
- .2 all substances for which a subsidiary risk label of "class ..." is required.

#### 7.2.3 Segregation provisions

7.2.3.1 To determine the segregation requirements between two or more dangerous goods, the segregation provisions, including the segregation table (7.2.4) and column 16 of the dangerous goods list shall be consulted, see also the annex to this chapter. In case of conflicting provisions, the provisions of column 16 of the dangerous goods list, always take precedence.

7.2.3.2 Whenever a segregation term applies (see 7.2.2.2), the goods are:

- .1 not permitted to be packed in the same outer packaging; and
- .2 not permitted to be transported in the same cargo transport unit except as provided in 7.2.6 and 7.3.4.

For “limited quantities” and “excepted quantities” see chapters 3.4 and 3.5.

7.2.3.3 Where the provisions of this Code indicate a single secondary hazard (one subsidiary risk label), the segregation provisions applicable to that hazard shall take precedence where they are more stringent than those of the primary hazard. The segregation provisions corresponding to a subsidiary risk of class 1 are those for class 1 division 1.3.

7.2.3.4 The segregation provisions for substances, materials or articles having more than two hazards (two or more subsidiary risk labels) are given in column 16 of the Dangerous Goods List.

For example:

In the Dangerous Goods List entry for BROMINE CHLORIDE, class 2.3, UN 2901, subsidiary risks 5.1 and 8, the following particular segregation is specified:

“segregation as for class 5.1, but “separated from” class 7”.

## 7.2.4 Segregation table

The general provisions for segregation between the various classes of dangerous goods are shown in the “segregation table” given below.

Since the properties of substances, materials or articles within each class may vary greatly, the dangerous goods list shall always be consulted for particular provisions for segregation as, in the case of conflicting provisions, these take precedence over the general provisions.

Segregation shall also take account of a single subsidiary risk label.

CLASS	1.1 1.2 1.5	1.3 1.6	1.4	2.1	2.2	2.3	3	4.1	4.2	4.3	5.1	5.2	6.1	6.2	7	8	9
Explosives 1.1, 1.2, 1.5	*	*	*	4	2	2	4	4	4	4	4	4	2	4	2	4	X
Explosives 1.3, 1.6	*	*	*	4	2	2	4	3	3	4	4	4	2	4	2	2	X
Explosives 1.4	*	*	*	2	1	1	2	2	2	2	2	2	X	4	2	2	X
Flammable gases 2.1	4	4	2	X	X	X	2	1	2	X	2	2	X	4	2	1	X
Non-toxic, non-flammable gases 2.2	2	2	1	X	X	X	1	X	1	X	X	1	X	2	1	X	X
Toxic gases 2.3	2	2	1	X	X	X	2	X	2	X	X	2	X	2	1	X	X
Flammable liquids 3	4	4	2	2	1	2	X	X	2	1	2	2	X	3	2	X	X
Flammable solids (including self-reactive substances and solid desensitized explosives) 4.1	4	3	2	1	X	X	X	X	1	X	1	2	X	3	2	1	X
Substances liable to spontaneous combustion 4.2	4	3	2	2	1	2	2	1	X	1	2	2	1	3	2	1	X
Substances which, in contact with water, emit flammable gases 4.3	4	4	2	X	X	X	1	X	1	X	2	2	X	2	2	1	X
Oxidizing substances (agents) 5.1	4	4	2	2	X	X	2	1	2	2	X	2	1	3	1	2	X
Organic peroxides 5.2	4	4	2	2	1	2	2	2	2	2	2	X	1	3	2	2	X
Toxic substances 6.1	2	2	X	X	X	X	X	X	1	X	1	1	X	1	X	X	X
Infectious substances 6.2	4	4	4	4	2	2	3	3	3	2	3	3	1	X	3	3	X
Radioactive material 7	2	2	2	1	1	2	2	2	2	1	2	X	3	X	2	X	
Corrosive substances 8	4	2	2	1	X	X	1	1	1	1	2	2	X	3	2	X	X
Miscellaneous dangerous substances and articles 9	X	X	X	X	X	X	X	X	X	X	X	X	X	X	X	X	X

The numbers and symbols in the table have the following meanings:

- 1 – “Away from”;
- 2 – “Separated from”;
- 3 – “Separated by a complete compartment or hold from”;
- 4 – “Separated longitudinally by an intervening complete compartment or hold from”.
- X – The Dangerous Goods List has to be consulted to verify whether there are specific segregation provisions.
- \* – See 7.2.7.1 of this chapter for the segregation provisions between class 1 substances or articles.

## 7.2.5 Segregation groups

7.2.5.1 For the purpose of segregation, dangerous goods having certain similar chemical properties have been grouped together in segregation groups as listed in 7.2.5.2. The entries allocated to these segregation groups are listed in 3.1.4.4. Where in the Dangerous Goods List entry in column 16 (stowage and segregation) a particular segregation requirement refers to a group of substances, such as "acids", the particular segregation requirement applies to the goods allocated to the respective segregation group.

7.2.5.2 Segregation groups referred to in the Dangerous Goods List:

- .1 acids
- .2 ammonium compounds
- .3 bromates
- .4 chlorates
- .5 chlorites
- .6 cyanides
- .7 heavy metals and their salts (including their organometallic compounds)
- .8 hypochlorites
- .9 lead and its compounds
- .10 liquid halogenated hydrocarbons
- .11 mercury and mercury compounds
- .12 nitrites and their mixtures
- .13 perchlorates
- .14 permanganates
- .15 powdered metals
- .16 peroxides
- .17 azides
- .18 alkalis.

7.2.5.3 It is recognized that not all substances, mixtures, solutions or preparations falling within a segregation group are listed in the IMDG Code by name. These are shipped under N.O.S. entries. Although these N.O.S. entries are not themselves listed in the segregation groups (see 3.1.4.4), the consignor shall decide whether inclusion under the segregation group is appropriate and, if so, shall mention that fact in the transport document (see 5.4.1.5.11).

7.2.5.4 The segregation groups in this Code do not cover substances which fall outside the classification criteria of this Code. It is recognized that some non-hazardous substances have similar chemical properties as substances listed in the segregation groups. A consignor or the person responsible for packing the goods into a cargo transport unit who does have knowledge of the chemical properties of such non-dangerous goods may decide to implement the segregation requirements of a related segregation group on a voluntary basis.

## 7.2.6 Special segregation provisions and exemptions

7.2.6.1 Notwithstanding 7.2.3.3 and 7.2.3.4, substances of the same class may be stowed together without regard to segregation required by secondary hazards (subsidiary risk label(s)), provided that the substances do not react dangerously with each other and cause:

- .1 combustion and/or evolution of considerable heat;
- .2 evolution of flammable, toxic or asphyxiant gases;
- .3 the formation of corrosive substances; or
- .4 the formation of unstable substances.

7.2.6.2 Where the Dangerous Goods List specifies that "segregation as for class ..." applies, the segregation provisions applicable to that class in 7.2.4 shall be applied. However, for the purposes of interpreting 7.2.6.1, which permits substances of the same class to be stowed together provided they do not react dangerously with each other, the segregation provisions of the class as represented by the primary hazard class in the Dangerous Goods List shall be applied.

For example:

UN 2965 – BORON TRIFLUORIDE DIMETHYL ETHERATE, class 4.3

The Dangerous Goods List entry specifies "segregation as for class 3, but "away from" classes 3, 4.1 and 8".



For the purposes of establishing the segregation provisions applicable in 7.2.4, the class 3 column shall be consulted.

This substance may be stowed together with other class 4.3 substances where they do not react dangerously with each other, see 7.2.6.1.

7.2.6.3 No segregation needs to be applied:

- .1 between dangerous goods of different classes which comprise the same substance but vary only in their water content, such as sodium sulphide in classes 4.2 and 8 or for class 7 if the difference is due to quantity only; and
- .2 between dangerous goods which belong to a group of substances of different classes but for which scientific evidence exists that they do not react dangerously when in contact with each other. Substances within the same table shown below are compatible with one another.

Table 1

UN	Proper Shipping Name	Class	Subsidiary risk(s)	Packing group
2014	HYDROGEN PEROXIDE, AQUEOUS SOLUTION with not less than 20% but not more than 60% hydrogen peroxide (stabilized as necessary)	5.1	8	II
2984	HYDROGEN PEROXIDE, AQUEOUS SOLUTION with not less than 8% but less than 20% hydrogen peroxide (stabilized as necessary)	5.1		III
3105	ORGANIC PEROXIDE TYPE D, LIQUID (peroxyacetic acid, type D, stabilized)	5.2	8	
3107	ORGANIC PEROXIDE TYPE E, LIQUID (peroxyacetic acid, type E, stabilized)	5.2	8	
3109	ORGANIC PEROXIDE TYPE F, LIQUID (peroxyacetic acid, type F, stabilized)	5.2	8	
3149	HYDROGEN PEROXIDE AND PEROXYACETIC ACID, MIXTURE with acid(s), water and not more than 5% peroxyacetic acid, STABILIZED	5.1	8	II

Table 2

UN	Proper Shipping Name	Class	Subsidiary risk(s)	Packing group
1295	TRICHLOROSILANE	4.3	3/8	I
1818	SILICON TETRACHLORIDE	8	–	II
2189	DICHLOROSILANE	2.3	2.1/8	–

7.2.6.4 Notwithstanding the provisions of 7.2.5, substances of class 8, packing group II or III, that would otherwise be required to be segregated from one another due to the provisions pertaining to segregation groups as identified by an entry in column (16) of the dangerous goods list indicating “away from” or “separated from” “acids” or “away from” or “separated from” “alkalis”, may be transported in the same cargo transport unit, whether in the same packaging or not, provided:

- .1 the substances comply with the provisions of 7.2.6.1;
- .2 the package does not contain more than 30 litres for liquids or 30 kg for solids;
- .3 the transport document includes the statement required by 5.4.1.5.11.3; and
- .4 a copy of the test report that verifies that the substances do not react dangerously with each other shall be provided if requested by the competent authority.

## 7.2.7 Segregation of goods of class 1

### 7.2.7.1 Segregation between goods of class 1

7.2.7.1.1 Goods of class 1 may be stowed within the same compartment or hold, or closed cargo transport unit as indicated in 7.2.7.1.4. In other cases, they shall be stowed in separate compartments or holds, or closed cargo transport units.

Part 7 – Provisions concerning transport operations

7.2.7.1.2 When goods requiring different stowage arrangements are permitted by 7.2.7.1.4 to be transported in the same compartment or hold, or closed cargo transport unit, the appropriate stowage arrangement shall conform to the most stringent provisions for the entire load.

7.2.7.1.3 Where a mixed load of different divisions is transported within the same compartment or hold, or closed cargo transport unit, the entire load shall be treated as if belonging to the hazard division in the order 1.1 (most dangerous), 1.5, 1.2, 1.3, 1.6 and 1.4 (least dangerous) and the stowage arrangement shall conform to the most stringent provisions for the entire load.

7.2.7.1.4 Permitted mixed stowage for goods of class 1

Compatibility group	A	B	C	D	E	F	G	H	J	K	L	N	S
A	X												
B		X											X
C			X	X <sup>6</sup>	X <sup>6</sup>		X <sup>1</sup>					X <sup>4</sup>	X
D			X <sup>6</sup>	X	X <sup>6</sup>		X <sup>1</sup>					X <sup>4</sup>	X
E			X <sup>6</sup>	X <sup>6</sup>	X		X <sup>1</sup>					X <sup>4</sup>	X
F						X							X
G			X <sup>1</sup>	X <sup>1</sup>	X <sup>1</sup>		X						X
H								X					X
J									X				X
K										X			X
L											X <sup>2</sup>		
N			X <sup>4</sup>	X <sup>4</sup>	X <sup>4</sup>							X <sup>3</sup>	X <sup>5</sup>
S		X	X	X	X	X	X	X	X	X		X <sup>5</sup>	X

“X” indicates that goods of the corresponding compatibility groups may be stowed in the same compartment, hold, or closed cargo transport unit

Notes:

- Explosive articles in compatibility group G (other than fireworks and those requiring special stowage) may be stowed with explosive articles of compatibility groups C, D and E provided no explosive substances are transported in the same compartment or hold, or closed cargo transport unit.
- A consignment of one type in compatibility group L shall only be stowed with a consignment of the same type within compatibility group L.
- Different types of articles of Division 1.6, compatibility group N, may only be transported together when it is proven that there is no additional risk of sympathetic detonation between the articles. Otherwise they shall be treated as Division 1.1.
- When articles of compatibility group N are transported with articles or substances of compatibility groups C, D or E, the goods of compatibility group N shall be treated as compatibility group D.
- When articles of compatibility group N are transported together with articles or substances of compatibility group S, the entire load shall be treated as compatibility group N.
- Any combination of articles in compatibility groups C, D and E shall be treated as compatibility group E. Any combination of substances in compatibility groups C and D shall be treated as the most appropriate compatibility group shown in 2.1.2.3, taking into account the predominant characteristics of the combined load. This overall classification code shall be displayed on any label or placard placed on a unit load or closed cargo transport unit as prescribed in 5.2.2.2.2.

7.2.7.1.5 Closed cargo transport units carrying different goods of class 1 do not require segregation from each other provided 7.2.7.1.4 authorizes the goods to be transported together. Where this is not permitted, closed cargo transport unit shall be “separated from” one another.

7.2.7.2 Segregation from goods of other classes

7.2.7.2.1 Notwithstanding the segregation provisions of this chapter, AMMONIUM NITRATE (UN 1942), AMMONIUM NITRATE FERTILIZERS (UN 2067), alkali metal nitrates (e.g., UN 1486) and alkaline earth metal nitrates (e.g., UN 1454) may be stowed together with blasting explosives (except EXPLOSIVE, BLASTING, TYPE C, UN 0083) provided the aggregate is treated as blasting explosives under class 1.

**Note:** Alkali metal nitrates include caesium nitrate (UN 1451), lithium nitrate (UN 2722), potassium nitrate (UN 1486), rubidium nitrate (UN 1477) and sodium nitrate (UN 1498). Alkaline earth metal nitrates include barium nitrate (UN 1446), beryllium nitrate (UN 2464), calcium nitrate (UN 1454), magnesium nitrate (UN 1474) and strontium nitrate (UN 1507).

Annex  
Segregation flow chart

The use of this chart is not mandatory and is provided for information purposes only.

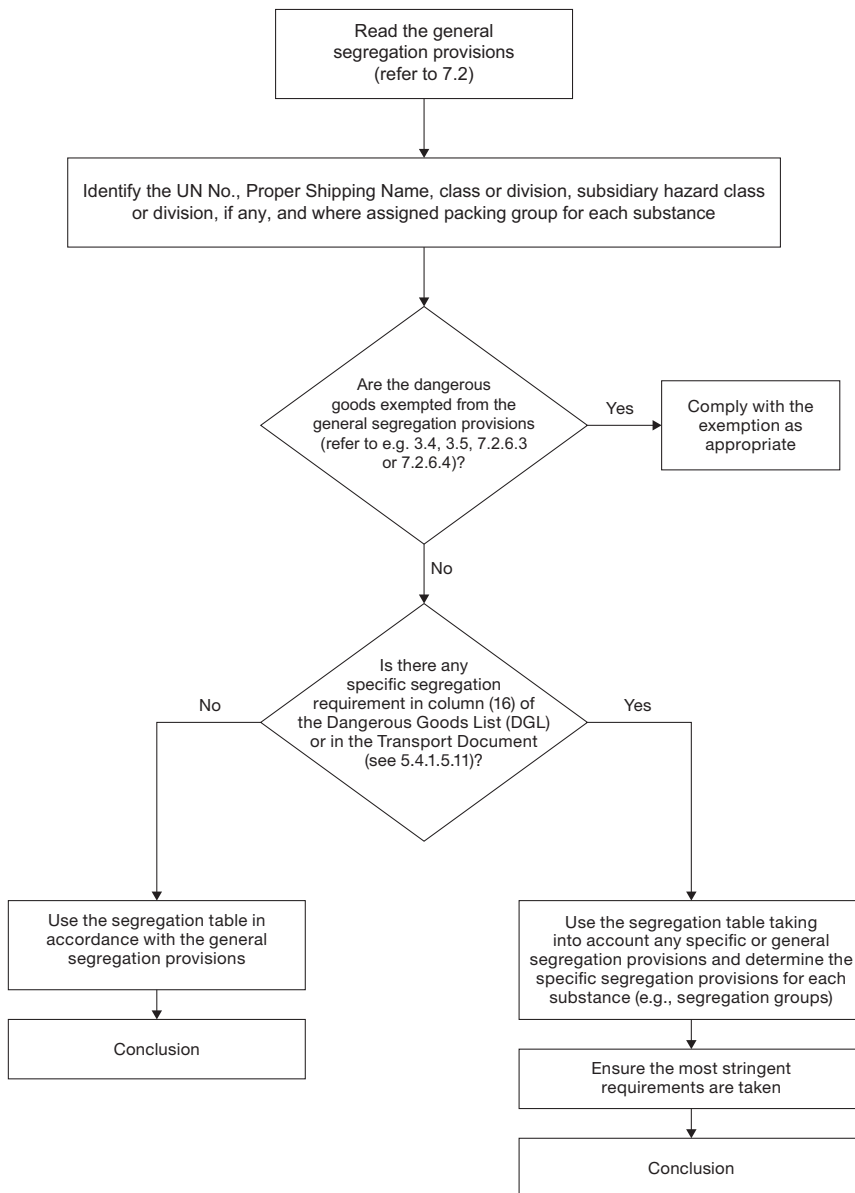

Part 7 – Provisions concerning transport operations

---

Examples

The following examples only illustrate the process of segregation. Subsequent additional provisions of this Code may apply (e.g 7.3.4).

- a. Segregation of 300 kg of celluloid, scrap (UN 2002) in one drum and 200 l of epibromohydrin (UN 2558) in one drum.
  - 1) According to the Dangerous Goods List, UN 2002 is class 4.2, PG III, and UN 2558 is class 6.1, PG I and has a subsidiary risk of class 3.
  - 2) Neither are exempted by 3.4, 3.5, 7.2.6.3 or 7.2.6.4.
  - 3) There are no specific segregation requirements for these substances in column (16) of the Dangerous Goods List.
  - 4) According to the segregation table given in 7.2.4 for classes 4.2 and 6.1, the intersecting box shows number 1, whereas for classes 4.2 and 3, the intersecting box shows a number 2. The value 2 is the more stringent, therefore the substances are required to be 'Separated from' one another.
- b. Segregation of 50 kg of potassium perchlorate (UN 1489) in one drum and 50 kg of nickel cyanide (UN 1653) in 1 drum.
  - 1) According to the Dangerous Goods List, UN 1489 is class 5.1, PG II and UN 1653 is class 6.1, PG II.
  - 2) Neither are exempted by 3.4, 3.5, 7.2.6.3 or 7.2.6.4.
  - 3) For UN 1489, column (16) of the Dangerous Goods List states: ""Separated from" ammonium compounds and cyanides".
  - 4) For UN 1653, column (16) of the Dangerous Goods List states: ""Separated from" acids".
  - 5) According to the segregation table given in 7.2.4 for classes 5.1 and 6.1, the intersecting box shows an "X".
  - 6) According to the segregation groups in section 3.1.4, UN 1653 is listed in group 6 (cyanides).
  - 7) Therefore, the substances are required to be "Separated from" one another.
- c. Segregation of 10 kg of acetone (UN 1090) in one box and 20 kg of ethyldichlorosilane (UN 1183) in an other box.
  - 1) According to the dangerous goods list, UN 1090 is class 3, PG II.
  - 2) According to the Dangerous Goods List, UN 1183 is class 4.3, PG I and has subsidiary risks of classes 3 and 8.
  - 3) Neither are exempted by 3.4, 3.5, 7.2.6.3 or 7.2.6.4.
  - 4) UN 1090 has no specific segregation requirements in column 16.
  - 5) For UN 1183, column (16) of the Dangerous Goods List states: "Segregation as for class 3 but "away from" classes 3, 4.1 and 8".
  - 6) According to the segregation table given in 7.2.4, the intersecting box shows an "X" for classes 3 and 3, but as UN 1183 is required to be 'away from' class 3, the substances are required to be "away from" one another.
- d. Segregation of 10 kg of adhesives (UN 1133, PG III) in limited quantities and 40 kg of beryllium nitrate (UN 2464) in the same freight container
  - 1) According to the Dangerous Goods List, UN 1133 is class 3, PG II.
  - 2) According to the Dangerous Goods List, UN 2464 is class 5.1, PG II and has a subsidiary risk of class 6.1.
  - 3) According to section 3.4, UN 1333 in limited quantities is exempted from the segregation provisions of Part 7.
  - 4) Therefore, no segregation requirements shall apply.

## Chapter 7.3

### *Consigning operations concerning the packing and use of cargo transport units (CTUs) and related provisions*

#### 7.3.1 Introduction

This chapter contains the provisions appropriate to those responsible for the consignment operations in the dangerous goods transport supply chain, including provisions relating to packing of dangerous goods into cargo transport units.

#### 7.3.2 General provisions for cargo transport units

7.3.2.1 Packages containing dangerous goods shall only be loaded in cargo transport units that are strong enough to withstand the shocks and loadings normally encountered during transport, having regard to the conditions to be expected during the anticipated journey. The cargo transport unit shall be constructed in such a way as to prevent the loss of contents. Where appropriate, the cargo transport unit shall be fitted with devices to facilitate securing and handling of the dangerous goods. The cargo transport units shall be adequately maintained.

7.3.2.2 Unless otherwise specified, the applicable provisions of the International Convention for Safe Containers (CSC) 1972, as amended, shall be followed for the use of any cargo transport unit which meets the definition of a "container" within the terms of that Convention.

7.3.2.3 The International Convention for Safe Containers does not apply to offshore containers that are handled in open seas. The design and testing of offshore containers shall take into account the dynamic lifting and impact forces that may occur when a container is handled in open seas in adverse weather and sea conditions. The requirement for such containers shall be determined by the approving competent authority. Such provisions should be based on MSC/Circ.860 "Guidelines for the Approval of Offshore Containers handled in Open Seas". Such containers shall be clearly marked with the words "OFFSHORE CONTAINER" on the safety approval plate.

#### 7.3.3 Packing of cargo transport units\*

7.3.3.1 The interior and exterior of a cargo transport unit shall be inspected prior to loading to ensure that there is no damage that could affect its integrity or that of the packages to be loaded in it.

7.3.3.2 Packages shall be examined and any found to be damaged, leaking or sifting shall not be packed into a cargo transport unit. Care shall be taken to see that excessive water, snow, ice or foreign matter adhering to packages is removed before packing into a cargo transport unit.

7.3.3.4 Drums containing dangerous goods shall always be stowed in an upright position unless otherwise authorized by the competent authority.

7.3.3.5 Cargo transport units shall be loaded in accordance with 7.3.4, so that incompatible dangerous or other goods are segregated. Specific loading instructions such as orientation arrows, not to be double stacked, keep dry or temperature control requirements shall be met. Liquid dangerous goods shall be loaded below dry dangerous goods whenever possible.

7.3.3.6 Packages containing dangerous goods and unpackaged dangerous articles shall be secured by suitable means capable of restraining the goods (such as fastening straps, sliding slatboards, adjustable brackets) in the cargo transport unit in a manner that will prevent any movement during transport which would change the orientation of the packages or cause them to be damaged. When dangerous goods are transported with other goods (e.g., heavy machinery or crates), all goods shall be securely fixed or packed in the cargo transport units so as to prevent the release of dangerous goods. Movement of packages may also be prevented

\* See IMO/ILO/UNECE Guidelines for Packing of Cargo Transport Units.

Part 7 – Provisions concerning transport operations

---

by filling any voids by the use of dunnage or by blocking and bracing. Where restraints such as banding or straps are used, these shall not be over-tightened to cause damage or deformation of the package or the securing points (such as D-rings) within the cargo transport unit. The packages shall be packed in such a way that there will be a minimum likelihood of damage to fittings during transport. Such fittings on packages shall be adequately protected. Where restraints such as banding or straps with integral container fittings are used, care should be taken to ensure that the Maximum Securing Load (MSL) of the fittings is not exceeded.

7.3.3.7 Packages shall not be stacked unless designed for that purpose. Where packages of different stacking designs are to be loaded together, consideration shall be given to their compatibility for stacking with each other. Where necessary, stacked packages shall be prevented from damaging the package below by the use of load bearing devices.

7.3.3.8 Cargo shall be entirely contained within the cargo transport unit without overhang or projections. Oversized machinery (such as tractors and vehicles) may overhang or project outside of the cargo transport unit provided that the dangerous goods integral to the machinery cannot leak or spill outside of the cargo transport unit.

7.3.3.9 During loading and unloading, packages containing dangerous goods shall be protected from being damaged. Particular attention shall be paid to the handling of packages during their preparation for transport, the type of cargo transport unit to be used for their carriage and to the method of loading or unloading, so that accidental damage is not caused through dragging or mishandling. Packages that appear to be leaking or damaged so that the contents may escape shall not be accepted for transport. If a package is found to be damaged so that the contents leak, the damaged package shall not be transported but moved to a safe place in accordance with instructions given by a competent authority or a designated responsible person who is familiar with the dangerous goods, the risks involved and the measures that should be taken in an emergency.

**Note 1:** Additional operational requirements for the transport of packagings and IBCs are provided in the special packing provisions for packagings and IBCs (see chapter 4.1).

7.3.3.10 When a dangerous goods consignment forms only part of the load of a cargo transport unit, it should, whenever possible, be packed adjacent to the doors with markings and labels visible, so as to be accessible in the event of an emergency or to facilitate inspection.

7.3.3.11 If the doors of a cargo transport unit are locked, the means of locking shall be such that, in cases of emergency, the doors can be opened without delay.

7.3.3.12 When venting is required, venting devices shall be kept clear and operable.

7.3.3.13 Cargo transport units containing dangerous goods shall be marked and placarded according to chapter 5.3. Irrelevant markings, labels, placards, orange panels, signs and marine pollutant marks shall be removed, masked or otherwise obliterated before packing a cargo transport unit.

7.3.3.14 Cargo transport units shall be packed so that the cargo is uniformly distributed consistent with the referenced guidelines\*.

7.3.3.15 If goods of class 1 are packed, the cargo transport unit shall comply with the definition in 7.1.2 for closed cargo transport unit for class 1.

7.3.3.16 If goods of class 7 are packed, the transport index and, if applicable, the criticality safety index, shall be limited according to 7.1.4.5.3.

7.3.3.17 Those responsible for the packing of dangerous goods into a cargo transport unit shall provide a “container/vehicle packing certificate” (see 5.4.2). This document is not required for tanks.

7.3.3.18 Flexible bulk containers are not allowed to be transported in cargo transport units (see 4.3.4).

### 7.3.4 Segregation provisions within cargo transport units

7.3.4.1 Dangerous goods which have to be segregated from each other according to the provisions in chapter 7.2 shall not be transported in the same cargo transport unit with the exception of dangerous goods which shall be segregated “away from” each other which may be transported in the same cargo transport unit with the approval of the competent authority. In such cases an equivalent standard of safety shall be maintained.

#### 7.3.4.2 Segregation in relation to foodstuffs

7.3.4.2.1 Dangerous goods having a primary or subsidiary risk of classes 2.3, 6.1, 6.2, 7 (with the exception of UN 2908, 2909, 2910 and 2911), 8 and dangerous goods having a reference to 7.3.4.2.1 in column 16 of the Dangerous Goods List shall not be transported together with foodstuffs (see 1.2.1) in the same cargo transport unit.

---

\* See IMO/ILO/UNECE Guidelines for Packing of Cargo Transport Units

7.3.4.2.2 Notwithstanding the provisions in 7.3.4.2.1, the following dangerous goods may be transported with foodstuffs provided that they are not loaded within 3 m from foodstuffs :

- .1 dangerous goods of packing group III of classes 6.1 and 8;
- .2 dangerous goods of packing group II of class 8; and
- .3 any other dangerous goods of packing group III with a subsidiary risk of classes 6.1 or 8; and
- .4 dangerous goods having a reference to 7.3.4.2.2 in column 16 of the Dangerous Goods List.

### 7.3.5 Tracking and monitoring equipment

When security devices, beacons or other tracking or monitoring equipment are used, they shall be securely installed to the cargo transport unit and shall be of a certified safe type\* for the dangerous goods that will be carried within the cargo transport unit.

### 7.3.6 Opening and unloading cargo transport units

7.3.6.1 Cargo transport units shall be approached with caution. Before opening the doors, the nature of the contents and the possibility that leakages may have caused an unsafe condition, concentration of toxic or flammable vapours, or an oxygen-enriched or oxygen-depleted atmosphere, shall be considered.

7.3.6.2 After a cargo transport unit carrying dangerous goods has been unpacked or unloaded, precautions shall be taken to ensure that there is no contamination likely to make the cargo transport unit dangerous.

7.3.6.3 After unpacking or unloading corrosive substances, particular attention shall be paid to cleaning, as residues may be highly corrosive to the metal structures.

7.3.6.4 When the cargo transport unit offers no further hazard, the dangerous goods placards and other marks related to dangerous goods shall be removed, masked or otherwise obliterated.

### 7.3.7 Cargo transport units under temperature control

#### 7.3.7.1 Preamble

7.3.7.1.1 If the temperature of certain substances (such as organic peroxides and self reactive substances) exceeds a value which is typical of the substance as packaged for transport, a self accelerating decomposition, possibly of explosive violence, may result. To prevent such decomposition, it is necessary to control the temperature of such substances during transport. Other substances not requiring temperature control for safety reasons may be transported under controlled temperature conditions for commercial reasons.

7.3.7.1.2 The provisions for the temperature control of certain specified substances are based on the assumption that the temperature in the immediate surroundings of the cargo does not exceed 55°C during transport and attains this value for a relatively short time only during each period of 24 hours.

7.3.7.1.3 If a substance which is not normally temperature controlled is transported under conditions where the temperature may exceed 55°C, it may require temperature control; in such cases, adequate measures shall be taken.

#### 7.3.7.2 General provisions

7.3.7.2.1 A self accelerating decomposition temperature (SADT)<sup>†</sup> shall be determined in order to decide if a substance shall be subjected to temperature control during transport. The relationship between SADT, the control temperature and the emergency temperature is as follows:

Type of receptacle	SADT*	Control temperature	Emergency temperature
Single packagings and IBC	20°C or less over 20°C to 35°C over 35°C	20°C below SADT 15°C below SADT 10°C below SADT	10°C below SADT 10°C below SADT 5°C below SADT
Portable tanks	< 50°C	10°C below SADT	5°C below SADT

\* Refer to the Recommendations published by the International Electrotechnical Commission, in particular, to publication IEC 60079.

† The self accelerating decomposition temperature (SADT) shall be determined in accordance with the latest version of the United Nations Recommendations on the Transport of Dangerous Goods, Manual of Tests and Criteria. Test methods for determining flammability are given in Part III, 32.4 of the United Nations Manual of Tests and Criteria. Because organic peroxides may react vigorously when heated, it is recommended to determine their flashpoint using small sample sizes such as described in ISO 3679.

## Part 7 – Provisions concerning transport operations

- 7.3.7.2.2 The substances for which a control temperature and an emergency temperature are indicated in 2.4.2.3.2.3 or 2.5.3.2.4 shall be transported under conditions of temperature control such that the temperature of the immediate surroundings of the cargo does not exceed the control temperature.
- 7.3.7.2.3 The actual transport temperature may be lower than the control temperature but shall be selected so as to avoid dangerous separation of phases.
- 7.3.7.2.4 The refrigeration system shall be subjected to a thorough inspection and a test prior to the cargo transport unit being packed to ensure that all parts are functioning properly.
- 7.3.7.2.5 When a cargo transport unit is to be filled with packages containing substances having different control temperatures, all packages shall be pre cooled to avoid exceeding the lowest control temperature.
- 7.3.7.2.5.1 In the event that non temperature controlled substances are transported in the same cargo transport unit as temperature controlled substances, the package(s) containing substances that require refrigeration shall be stowed in such a way as to be readily accessible from the door(s) of the cargo transport unit.
- 7.3.7.2.5.2 If substances with different control temperatures are loaded in the cargo transport unit, the substances with the lowest control temperature shall be stowed in the most readily accessible position from the doors of the cargo transport unit.
- 7.3.7.2.5.3 The door(s) shall be capable of being opened readily in case of emergency so that the package(s) can be removed. The carrier shall be informed about the location of the different substances within the unit. The cargo shall be secured to prevent packages from falling when the door(s) is (are) opened. The packages shall be securely stowed so as to allow for adequate air circulation throughout the cargo.
- 7.3.7.2.6 The master shall be provided with operating instructions for the refrigeration system, procedures to be followed in the event of loss of control and instructions for regular monitoring of operating temperatures. Spare parts shall be carried for the systems described in 7.3.7.3.2.3 and 7.3.7.3.2.4, 7.3.7.3.2.5 so that they are available for emergency use should the refrigeration system malfunction during transport.
- 7.3.7.2.7 In cases where it may not be possible to carry specific substances according to the general provisions, full details of the proposed method of shipment shall be submitted to the competent authority concerned for approval.
- 7.3.7.3 Methods of temperature control**
- 7.3.7.3.1 The suitability of a particular means of temperature control for transport depends on a number of factors. Among those to be considered are:
- .1 the control temperature(s) of the substance(s) to be transported;
  - .2 the difference between the control temperature and the anticipated ambient temperature conditions;
  - .3 the effectiveness of the thermal insulation of the cargo transport unit. The overall heat transfer coefficient shall not be more than  $0.4 \text{ W} / (\text{m}^2 \cdot \text{K})$  for cargo transport units and  $0.6 \text{ W} / (\text{m}^2 \cdot \text{K})$  for tanks; and
  - .4 the duration of the voyage.
- 7.3.7.3.2 Suitable methods for preventing the control temperature being exceeded are, in order of increasing capability:
- .1 thermal insulation, provided that the initial temperature of the substance is sufficiently below the control temperature;
  - .2 thermal insulation with a cooling method, provided that:
    - an adequate quantity of non flammable coolant (such as liquid nitrogen or solid carbon dioxide), allowing a reasonable margin for delay, is carried;
    - liquid oxygen or air is not used as a coolant;
    - there is uniform cooling effect even when most of the coolant has been consumed; and
    - the need to ventilate the cargo transport unit before entering is clearly indicated by a warning on the door(s) (see 5.5.3);
  - .3 single mechanical refrigeration, provided that the unit is thermally insulated and, for substances with a flashpoint lower than the sum of the emergency temperature plus 5°C, explosion proof electrical fittings are used within the cooling compartment to prevent ignition of flammable vapours from the substances;
  - .4 combined mechanical refrigeration system and cooling method, provided that:
    - the two systems are independent of one another; and
    - the provisions of 7.3.7.3.2.2 and 7.3.7.3.2.3 are met;
  - .5 dual mechanical refrigeration system, provided that:
    - apart from the integral power supply unit, the two systems are independent of one another;
    - each system alone is capable of maintaining adequate temperature control; and



**Chapter 7.3 – Consigning operations concerning the packing and use of CTUs**

- for substances with a flashpoint lower than the sum of the emergency temperature plus 5°C, explosion proof electrical fittings are used within the coolant compartment to prevent ignition of flammable vapours from the substances.
- 7.3.7.3.3** The refrigeration equipment and its controls shall be readily and safely accessible and all electrical connections weatherproof. Inside the cargo transport unit, the temperature shall be measured continuously. The measurement shall be taken in the air space of the unit, using two measuring devices independent of each other. The type and place of the measuring devices shall be selected so that their results are representative of the actual temperature in the cargo. At least one of the two measurements shall be recorded in such a manner that temperature changes are easily detectable.
- 7.3.7.3.4** If substances are transported with a control temperature less than +25°C, the cargo transport unit shall be equipped with a visible and audible alarm effectively set at no higher than the control temperature. The alarms shall work independently from the power supply of the refrigeration system.
- 7.3.7.3.5** If an electrical supply is necessary for the cargo transport unit to operate the refrigeration or heating equipment, it shall be ensured that the correct connecting plugs are fitted. For under deck stowage, plugs shall, as a minimum, be of an IP 55 enclosure in accordance with IEC Publication 60529\*, with the specification for electrical equipment of temperature class T4 and explosion group IIB. However, when stowed on deck, these plugs shall be of an IP 56 enclosure in accordance with IEC Publication 60529\*
- 7.3.7.4 Special provisions for self reactive substances (class 4.1) and organic peroxides (class 5.2)**
- 7.3.7.4.1** For self reactive substances (class 4.1) identified by UN Nos. 3231 and 3232 and organic peroxides (class 5.2) identified by UN Nos. 3111 and 3112, one of the following methods of temperature control described in 7.3.7.3.2 shall be used:
- .1 the methods referred to under 7.3.7.3.2.4 or 7.3.7.3.2.5; or
  - .2 the method referred to under 7.3.7.3.2.3 when the maximum ambient temperature to be expected during transport is at least 10°C below the control temperature.
- 7.3.7.4.2** For self reactive substances (class 4.1) identified by UN Nos. 3233 to 3240 and organic peroxides (class 5.2) identified by UN Nos. 3113 to 3120, one of the following methods shall be used:
- .1 the methods referred to under 7.3.7.3.2.4 or 7.3.7.3.2.5;
  - .2 the method referred to under 7.3.7.3.2.3 when the maximum ambient temperature to be expected during transport does not exceed the control temperature by more than 10°C; or
  - .3 for short international voyages only (see 1.2.1), the methods referred to under 7.3.7.3.2.1 and 7.3.7.3.2.2 when the maximum ambient temperature to be expected during transport is at least 10°C below the control temperature.
- 7.3.7.5 Special provisions applicable to the transport of substances stabilized by temperature control (other than self-reactive substances and organic peroxides)**
- 7.3.7.5.1** These provisions apply to the transport of substances:
- .1 the Proper Shipping Name of which contains the word “STABILIZED”; and
  - .2 for which the SADT (see 7.3.7.2.1) as presented for transport in the package, IBC or tank is 50°C or lower.
- When chemical inhibition is not used to stabilize a reactive substance which may generate dangerous amounts of heat and gas, or vapour, under normal transport conditions, these substances shall be transported under temperature control. These provisions do not apply to substances which are stabilized by the addition of chemical inhibitors such that the SADT is greater than 50°C.
- 7.3.7.5.2** The provisions in 7.3.7.2.1 to 7.3.7.2.3 and 7.3.7.3 apply to substances meeting criteria .1 and .2 in 7.3.7.5.1.
- 7.3.7.5.3** The actual transport temperature may be lower than the control temperature (see 7.3.7.2.1) but shall be selected so as to avoid dangerous separation of phases.
- 7.3.7.5.4** When these substances are transported in IBCs or portable tanks, the provisions for a SELF-REACTIVE LIQUID TYPE F, TEMPERATURE CONTROLLED shall apply. For transport in IBCs, see the special provisions in 4.1.7.2 and the “Additional provisions” in packing instruction IBC520; for transport in portable tanks, see the additional provisions in 4.2.1.13.

\* Reference is made to the Recommendations published by the International Electrotechnical Commission (IEC) and, in particular, to Publication 60529 Classification of Degrees of Protection provided by Enclosures.

Part 7 – Provisions concerning transport operations

---

**7.3.7.5.5** If a substance the Proper Shipping Name of which contains the word "STABILIZED" and which is not normally required to be transported under temperature control is transported under conditions where the temperature may exceed 55°C, it may require temperature control.

**7.3.7.6 Special provisions for flammable gases or liquids having a flashpoint less than 23°C c.c. transported under temperature control**

**7.3.7.6.1** When flammable gases or liquids having a flashpoint less than 23°C c.c. are packed or loaded in a cargo transport unit equipped with a refrigerating or heating system, the cooling or heating equipment shall comply with 7.3.7.3.

**7.3.7.6.2** When flammable liquids having a flashpoint less than 23°C c.c. and not requiring temperature control for safety reasons are transported under temperature control conditions for commercial reasons, explosion proof electrical fittings are required except when the substances are pre cooled to and transported at a control temperature of at least 10°C below the flashpoint. In case of failure of a non explosion proof refrigerating system, the system shall be disconnected from the power supply. It shall not be reconnected if the temperature has risen to a temperature less than 10°C below the flashpoint.

**7.3.7.6.3** When flammable gases not requiring temperature control for safety reasons are transported under temperature control conditions for commercial reasons, explosion proof electrical fittings are required.

**7.3.7.7 Special provisions for vehicles transported on ships**

Insulated, refrigerated and mechanically refrigerated vehicles shall conform to the provisions of 7.3.7.3 and 7.3.7.4 or 7.3.7.5 as appropriate. In addition, the refrigerating appliance of a mechanically refrigerated vehicle shall be capable of operating independently of the engine used to propel the vehicle.

**7.3.7.8 Approval**

The competent authority may approve that less stringent means of temperature control may be used or that artificial refrigeration may be dispensed with under conditions of transport such as short international voyages or low ambient temperatures.

**7.3.8 Loading of cargo transport units on board ships**

Before loading, cargo transport units used for the transport of dangerous goods shall be examined for external signs of damage, leakage or sifting of contents. Any cargo transport unit found to be damaged, leaking or sifting shall not be loaded on to a ship until repairs have been effected or damaged packages have been removed.

## Chapter 7.4

### *Stowage and segregation on containerships*

**Note:** To facilitate familiarization with these requirements and to support training of relevant personnel, illustrations applicable to the segregation requirements on containerships are given in MSC/Circ.[...].

#### 7.4.1 Introduction

7.4.1.1 The provisions of this chapter apply to the stowage and segregation of containers which meet the definition of a container within the term of the International Convention for Safe Containers (CSC) 1972, as amended, which are transported on deck and in the cargo holds of container ships or on deck and in the cargo holds of other types of ships provided that these stowage positions are properly fitted to give a permanent stowage of containers during transport.

7.4.1.2 For ships carrying containers in conventional cargo spaces not properly fitted for the permanent stowage of containers the provisions of chapter 7.6 apply.

7.4.1.3 For stowage of FISHMEAL, UNSTABILIZED (UN 1374), FISHMEAL, STABILIZED (UN 2219) and KRILL MEAL (UN 3497) in containers, the provisions of 7.6.2.7.2.2 also apply.

7.4.1.4 For stowage of AMMONIUM NITRATE (UN 1942), AMMONIUM NITRATE BASED FERTILIZER (UN 2067 AND 2071) in containers, the applicable provisions of 7.6.2.8.4 and 7.6.2.11.1 also apply.

#### 7.4.2 Stowage requirements

##### 7.4.2.1 Provisions for hatchless containerships

Dangerous goods shall only be transported in or vertically above hatchless container holds if:

- .1 the dangerous goods are permitted for under deck stowage as specified in the Dangerous Goods List; and
- .2 the hatchless container hold is in full compliance with the provisions of regulation II 2/19 of SOLAS 74, as amended, or regulation II 2/54 of SOLAS 74, as amended by the resolutions indicated in II 2/1.2.1, as applicable.

##### 7.4.2.2 Provisions for ships with partially weathertight hatchway covers

###### 7.4.2.2.1 *Provisions for partially weathertight hatchway covers with effective gutterbars\**

7.4.2.2.1.1 Partially weathertight hatchway covers fitted with effective gutterbars\* can be regarded as "resistant to fire and liquid" for the purpose of stowage and segregation of containers containing dangerous goods on containerships fitted with such hatchway covers. Additionally segregation requirements shall be in accordance with the requirements in paragraph 7.4.3.2.

7.4.2.2.1.2 When "not in the same vertical line unless separated by a deck" is required, containers containing dangerous goods shall not be stowed in any tier directly above a clear gap\* unless the cargo hold complies with the relevant requirements for the class and flashpoint of the dangerous goods in regulation II-2/19 of SOLAS 74, as amended, or regulation II-2/54 of SOLAS 74, as amended by resolutions indicated in II-2/1.2.1, as applicable. Additionally, containers containing incompatible dangerous goods shall not be stowed within the relevant sensitive vertical lines\* under deck.

###### 7.4.2.2.2 *Provisions for partially weathertight hatchway covers without effective gutterbars\**

7.4.2.2.2.1 Where hatchway covers are not fitted with effective gutterbars, containers containing dangerous goods shall not be stowed on such hatchway covers, unless the cargo hold complies with the relevant requirements for

\* For definitions and details see MSC/Circ.1087 found in the IMDG Code Supplement.

## Part 7 – Provisions concerning transport operations

the class and flashpoint of the dangerous goods in regulation II 2/19 of SOLAS 74, as amended, or regulation II 2/54 of SOLAS 74, as amended by the resolutions indicated in II 2/1.2.1, as applicable.

7.4.2.2.2.2 Where hatchway covers are not fitted with effective gutterbars<sup>\*</sup>, the following applies where stowage “not in the same vertical line” is required in 7.4.3.3.

7.4.2.2.2.3 When containers containing dangerous goods are stowed on deck, containers containing incompatible dangerous goods shall not be stowed within the relevant sensitive vertical lines<sup>\*</sup> of any clear gap<sup>\*</sup> on either side of the hatchway cover below deck.

7.4.2.2.2.4 When containers containing dangerous goods are stowed below deck within the relevant sensitive vertical lines of a clear gap, containers with incompatible dangerous goods shall not be stowed on the hatches above the hold<sup>\*</sup>.

#### 7.4.2.3 Provisions for containers with flammable gases and highly flammable liquids

7.4.2.3.1 In cargo ships of 500 gross tons or over and passenger ships constructed before 1st September 1984, and in cargo ships of less than 500 gross tons constructed before 1st February 1992, containers with flammable gases or with flammable liquids having a flashpoint of less than 23°C c.c., shall be stowed on deck only, unless otherwise approved by the Administration.

7.4.2.3.2 A container with flammable gases or with flammable liquids having a flashpoint of less than 23°C c.c. transported on deck shall be stowed at least 2.4 m from any potential source of ignition.

7.4.2.3.3 A container under temperature control that is not of a certified safe type shall not be stowed under deck together with containers containing flammable gases or with liquids having a flashpoint of less than 23°C c.c.

#### 7.4.2.4 Ventilation provisions

7.4.2.4.1 In cargo ships of 500 gross tons or over and passenger ships constructed before 1st September 1984, and in cargo ships of less than 500 gross tons constructed before 1st February 1992, containers with the following dangerous goods, may be stowed under deck only if the cargo space is equipped with mechanical ventilation and if under deck stowage is permitted in the Dangerous Goods List:

- dangerous goods of class 2.1;
- dangerous goods of class 3 with a flash point of less than 23°C c.c.;
- dangerous goods of class 4.3;
- dangerous goods of class 6.1 with a subsidiary risk of class 3;
- dangerous goods of class 8 with a subsidiary risk of class 3, and
- dangerous goods to which a specific stowage requirement requiring mechanical ventilation in column 16 of the Dangerous Goods List is assigned.

Otherwise containers shall be stowed on deck only.

7.4.2.4.2 The capacity of the mechanical ventilation (number of air changes per hour) shall be to the satisfaction of the Administration.

### 7.4.3 Segregation requirements

#### 7.4.3.1 Definitions and application

7.4.3.1.1 Container space means a distance of not less than 6 m fore and aft or not less than 2.4 m athwartships.

7.4.3.1.2 The provisions for segregation between containers onboard container ships with closed cargo holds and onboard hatchless container ships are given in the tables in 7.4.3.2 and 7.4.3.3 respectively.

<sup>\*</sup> \* For definitions and details see MSC/Circ.1087 found in the IMDG Code Supplement.

7.4.3.2 Table of segregation of containers on board container ships with closed cargo holds

SEGREGATION REQUIREMENT	VERTICAL			HORIZONTAL					
	CLOSED VERSUS CLOSED	CLOSED VERSUS OPEN	OPEN VERSUS OPEN	CLOSED VERSUS CLOSED		CLOSED VERSUS OPEN		OPEN VERSUS OPEN	
				ON DECK	UNDER DECK	ON DECK	UNDER DECK	ON DECK	UNDER DECK
"AWAY FROM" .1	ONE ON TOP OF THE OTHER PERMITTED	OPEN ON TOP OF CLOSED PERMITTED		NO RESTRICTION	NO RESTRICTION	NO RESTRICTION	NO RESTRICTION	ONE CONTAINER SPACE	ONE CONTAINER SPACE OR ONE BULKHEAD
"SEPARATED FROM" .2	NOT IN THE SAME VERTICAL LINE UNLESS SEGREGATED BY A DECK	NOT IN THE SAME VERTICAL LINE UNLESS SEGREGATED BY A DECK	NOT IN THE SAME VERTICAL LINE UNLESS SEGREGATED BY A DECK	NO RESTRICTION	NO RESTRICTION	NO RESTRICTION	NO RESTRICTION	ONE CONTAINER SPACE	ONE CONTAINER SPACE
"SEPARATED BY A COMPLETE COMPARTMENT OR HOLD FROM" .3	NOT IN THE SAME VERTICAL LINE UNLESS SEGREGATED BY A DECK	AS FOR "OPEN VERSUS OPEN"		ONE CONTAINER SPACE	ONE CONTAINER SPACE	ONE CONTAINER SPACE	ONE CONTAINER SPACE OR ONE BULKHEAD	ONE CONTAINER SPACE	ONE BULKHEAD
"SEPARATED LONGITUDINALLY BY AN INTERVENING COMPLETE COMPARTMENT OR HOLD FROM" .4*		PROHIBITED		PROHIBITED	PROHIBITED	PROHIBITED	PROHIBITED	PROHIBITED	PROHIBITED

\* Containers not less than 6 m from intervening bulkhead.

Note: All bulkheads and decks shall be resistant to fire and liquids.

Part 7 – Provisions concerning transport operations

7.4.3.3 Table of segregation of containers on board hatchless container ships

SEGREGATION REQUIREMENT	VERTICAL		HORIZONTAL								
	CLOSED VERSUS CLOSED	CLOSED VERSUS OPEN	OPEN VERSUS OPEN		CLOSED VERSUS CLOSED		CLOSED VERSUS OPEN		OPEN VERSUS OPEN		
			ON DECK	UNDER DECK	ON DECK	UNDER DECK	ON DECK	UNDER DECK	ON DECK	UNDER DECK	
"AWAY FROM" .1	ONE ON TOP OF THE OTHER PERMITTED	OPEN ON TOP OF CLOSED PERMITTED OTHERWISE AS FOR "OPEN VERSUS OPEN"	FORE AND AFT	NO RESTRICTION	NO RESTRICTION	NO RESTRICTION	NO RESTRICTION	NO RESTRICTION	NO RESTRICTION	ONE CONTAINER SPACE OR ONE BULKHEAD	ONE CONTAINER SPACE OR ONE BULKHEAD
"SEPARATED FROM" .2			ATHWART-SHIPS	NO RESTRICTION	NO RESTRICTION	NO RESTRICTION	NO RESTRICTION	NO RESTRICTION	NO RESTRICTION	ONE CONTAINER SPACE	ONE CONTAINER SPACE
			FORE AND AFT	ONE CONTAINER SPACE OR ONE BULKHEAD	ONE CONTAINER SPACE	ONE CONTAINER SPACE	ONE CONTAINER SPACE	ONE CONTAINER SPACE OR ONE BULKHEAD	ONE CONTAINER SPACE AND NOT IN OR ABOVE SAME HOLD	ONE CONTAINER SPACE AND NOT IN OR ABOVE SAME HOLD	ONE BULKHEAD
			ATHWART-SHIPS	ONE CONTAINER SPACE	ONE CONTAINER SPACE	ONE CONTAINER SPACE	TWO CONTAINER SPACES	TWO CONTAINER SPACES	TWO CONTAINER SPACES	TWO CONTAINER SPACES AND NOT IN OR ABOVE SAME HOLD	ONE BULKHEAD
"SEPARATED BY A COMPLETE COMPARTMENT OR HOLD FROM" .3	NOT IN THE SAME VERTICAL LINE	AS FOR "OPEN VERSUS OPEN"	FORE AND AFT	ONE CONTAINER SPACE AND NOT IN OR ABOVE SAME HOLD	ONE CONTAINER SPACE AND NOT IN OR ABOVE SAME HOLD	ONE CONTAINER SPACE AND NOT IN OR ABOVE SAME HOLD	ONE CONTAINER SPACE AND NOT IN OR ABOVE SAME HOLD	ONE BULKHEAD	ONE BULKHEAD	TWO CONTAINER SPACES AND NOT IN OR ABOVE SAME HOLD	TWO BULKHEADS
			ATHWART-SHIPS	TWO CONTAINER SPACES AND NOT IN OR ABOVE SAME HOLD	TWO CONTAINER SPACES AND NOT IN OR ABOVE SAME HOLD	TWO CONTAINER SPACES AND NOT IN OR ABOVE SAME HOLD	TWO CONTAINER SPACES AND NOT IN OR ABOVE SAME HOLD	ONE BULKHEAD	ONE BULKHEAD	THREE CONTAINER SPACES AND NOT IN OR ABOVE SAME HOLD	TWO BULKHEADS
"SEPARATED LONGITUDINALLY BY AN INTERVENING COMPLETE COMPARTMENT OR HOLD FROM" .4		PROHIBITED	FORE AND AFT	MINIMUM HORIZONTAL DISTANCE OF 24 M AND NOT IN OR ABOVE SAME HOLD	ONE BULKHEAD AND MINIMUM HORIZONTAL DISTANCE OF 24 M	MINIMUM HORIZONTAL DISTANCE OF 24 M AND NOT IN OR ABOVE SAME HOLD	MINIMUM HORIZONTAL DISTANCE OF 24 M AND NOT IN OR ABOVE SAME HOLD	TWO BULKHEADS	TWO BULKHEADS	MINIMUM HORIZONTAL DISTANCE OF 24 M AND NOT IN OR ABOVE SAME HOLD	TWO BULKHEADS
			ATHWART-SHIPS	PROHIBITED	PROHIBITED	PROHIBITED	PROHIBITED	PROHIBITED	PROHIBITED	PROHIBITED	PROHIBITED

\* Containers not less than 6 m from intervening bulkhead.

Note: All bulkheads and decks shall be resistant to fire and liquids.

## Chapter 7.5

### *Stowage and segregation on ro-ro ships*

**Note:** To facilitate familiarization with these requirements and to support training of relevant personnel, illustrations applicable to the segregation requirements on ro-ro ships are given in MSC/Circ.[.].

#### 7.5.1 Introduction

- 7.5.1.1 The provisions of this chapter apply to the stowage and segregation of cargo transport units which are transported in ro-ro cargo spaces.
- 7.5.1.2 For ro-ro ships which incorporate stowage positions which are properly fitted to give a permanent stowage of containers during transport, the provisions of chapter 7.4 apply for containers carried in these spaces.
- 7.5.1.3 For ro-ro ships which incorporate conventional cargo spaces, the provisions of chapter 7.6 apply in these spaces.
- 7.5.1.4 In case more than one container is loaded on the same chassis in a ro-ro-cargo space, the segregation of chapter 7.4 apply between the containers.

#### 7.5.2 Stowage provisions

- 7.5.2.1 Loading and unloading operations on each ro-ro cargo space shall take place under the supervision of either a working party consisting of officers and other crew members or responsible persons appointed by the master.
- 7.5.2.2 During the voyage, access to such spaces by passengers and other unauthorized persons shall only be permitted when such persons are accompanied by an authorized crew member.
- 7.5.2.3 All doors leading directly to these spaces shall be securely closed during the voyage and notices or signs prohibiting entrance to such spaces shall be conspicuously displayed.
- 7.5.2.4 The transport of dangerous goods shall be prohibited in any ro-ro cargo space in which the foregoing provisions cannot be met.
- 7.5.2.5 Closing arrangements for the openings between ro-ro cargo spaces and machinery and accommodation spaces shall be such as to avoid the possibility of dangerous vapours and liquids entering such spaces. Such openings shall normally be kept securely closed when dangerous cargo is on board, except to permit access by authorized persons or for emergency use.
- 7.5.2.6 Dangerous goods required to be carried on deck only shall not be carried in closed ro-ro cargo spaces, but may be carried in open ro-ro cargo spaces when authorized by the Administration.
- 7.5.2.7 Flammable gases or liquids having a flashpoint of less than 23°C c.c. shall not be stowed in a closed ro ro cargo space or special category space on a passenger ship unless:
- the design, construction and equipment of the space comply with the provisions of regulation II 2/19 of SOLAS 74, as amended, or regulation II 2/54 of SOLAS 74, as amended by the resolutions indicated in II 2/1.2.1, as applicable, and the ventilation system is operated to maintain at least six air changes per hour; or
  - the ventilation system of the space is operated to maintain at least ten air changes per hour and non certified safe electrical systems in the space are capable of being isolated by means other than removal of fuses in the event of failure of the ventilation system or any other circumstance likely to cause accumulation of flammable vapours.
- Otherwise stowage is restricted to on deck only.
- 7.5.2.8 Cargo transport units with flammable gases or liquids having a flashpoint of less than 23°C c.c. and transported on deck shall be stowed at least 3 m from any potential sources of ignition.

**Part 7 – Provisions concerning transport operations**

- 7.5.2.9 Mechanically operated refrigeration or heating equipment fitted to any cargo transport unit shall not be operated during the voyage when stowed in a closed ro ro cargo space or a special category space on a passenger ship.
- 7.5.2.10 Electrically operated refrigeration or heating equipment fitted to any cargo transport unit stowed in a closed ro ro cargo space or special category space on a passenger ship shall not be operated when flammable gases or liquids having a flashpoint of less than 23°C c.c. are present in the cargo transport unit or in the same space, unless:
  - the design, construction and equipment of the space comply with the provisions of regulation II 2/19 of SOLAS 1974, as amended, or regulation II 2/54 of SOLAS 74, as amended by the resolutions indicated II 2/1.2.1, as applicable; or
  - the ventilation system of the space is operated to maintain at least ten air changes per hour and all electrical systems in the space are capable of being isolated by means other than removal of fuses in the event of ventilation failure or other circumstance likely to cause accumulation of flammable vapours;
  - and, in either case, the refrigeration or heating equipment of the cargo transport unit shall comply with paragraph 7.3.7.6.
- 7.5.2.11 In ships the keel of which was laid before 1 September 1984 and for which regulation II 2/20 of SOLAS 74, as amended, or regulations II 2/37 and 38 of SOLAS 74, as amended by the resolutions indicated in II 2/1.2.1, are not applicable to a closed ro-ro cargo space, mechanical ventilation shall be provided to the satisfaction of the Administration. The ventilation fans shall be operating at all times when vehicles are in such spaces.
- 7.5.2.12 If continuous ventilation is impracticable in a closed ro-ro cargo space other than a special category space on a passenger ship, ventilation fans shall be operated daily for a limited period, as weather permits. In any case, prior to discharge, the fans shall be operated for a reasonable period. The ro-ro cargo space shall be proved gas-free at the end of the period. When the ventilation is not continuous, electrical systems which are not certified safe shall be isolated.
- 7.5.2.13 The master of a ship carrying dangerous goods in ro-ro cargo spaces shall ensure that, during loading and unloading operations and during the voyage, regular inspections of these spaces are made by an authorized crew member or responsible person in order to achieve early detection of any hazard.

**7.5.3 Segregation provisions**

7.5.3.1 The provisions for segregation between cargo transport units onboard ro-ro ships are given in the table in 7.5.3.2.

7.5.3.2 Table of segregation of cargo transport units on board ro-ro ships

SEGREGATION REQUIREMENT	HORIZONTAL						
		CLOSED VERSUS CLOSED		CLOSED VERSUS OPEN		OPEN VERSUS OPEN	
		ON DECK	UNDER DECK	ON DECK	UNDER DECK	ON DECK	UNDER DECK
"AWAY FROM" .1	FORE AND AFT	NO RESTRICTION	NO RESTRICTION	NO RESTRICTION	NO RESTRICTION	AT LEAST 3 METRES	AT LEAST 3 METRES
	ATHWARTSHIPS	NO RESTRICTION	NO RESTRICTION	NO RESTRICTION	NO RESTRICTION	AT LEAST 3 METRES	AT LEAST 3 METRES
"SEPARATED FROM" .2	FORE AND AFT	AT LEAST 6 METRES	AT LEAST 6 METRES OR ONE BULKHEAD	AT LEAST 6 METRES	AT LEAST 6 METRES OR ONE BULKHEAD	AT LEAST 6 METRES	AT LEAST 12 METRES OR ONE BULKHEAD
	ATHWARTSHIPS	AT LEAST 3 METRES	AT LEAST 3 METRES OR ONE BULKHEAD	AT LEAST 3 METRES	AT LEAST 6 METRES OR ONE BULKHEAD	AT LEAST 6 METRES	AT LEAST 12 METRES OR ONE BULKHEAD
"SEPARATED BY A COMPLETE COMPARTMENT OR HOLD FROM" .3	FORE AND AFT	AT LEAST 12 METRES	AT LEAST 24 METRES + DECK	AT LEAST 24 METRES	AT LEAST 24 METRES + DECK	AT LEAST 36 METRES	TWO DECKS OR TWO BULKHEADS
	ATHWARTSHIPS	AT LEAST 12 METRES	AT LEAST 24 METRES + DECK	AT LEAST 24 METRES	AT LEAST 24 METRES + DECK	PROHIBITED	PROHIBITED
"SEPARATED LONGITUDINALLY BY AN INTERVENING COMPLETE COMPARTMENT OR HOLD FROM" .4	FORE AND AFT	AT LEAST 36 METRES	TWO BULKHEADS OR AT LEAST 36 METRES + TWO DECKS	AT LEAST 36 METRES	AT LEAST 48 METRES INCLUDING TWO BULKHEADS	AT LEAST 48 METRES	PROHIBITED
	ATHWARTSHIPS	PROHIBITED	PROHIBITED	PROHIBITED	PROHIBITED	PROHIBITED	PROHIBITED

Note: All bulkheads and decks shall be resistant to fire and liquid.



## Chapter 7.6

### *Stowage and segregation on general cargo ships*

#### 7.6.1 Introduction

- 7.6.1.1 The provisions of this chapter apply to the stowage and segregation of dangerous goods stowed in the conventional way on board general cargo ships. They apply also to containers which are transported in conventional cargo spaces, including cargo spaces on the weather deck, not properly fitted to give a permanent stowage of the containers during transport.
- 7.6.1.2 For ships carrying containers in stowage positions which are properly fitted for the permanent stowage of containers the provisions of chapter 7.4 apply.

#### 7.6.2 Stowage and handling provisions

##### 7.6.2.1 Provisions for all classes

- 7.6.2.1.1 The minimum stacking height for testing packagings intended to contain dangerous goods in accordance with chapter 6.1 is 3 m. For IBCs and large packagings, the stacking test load shall be determined in accordance with 6.5.6.6.4 and 6.6.5.3.3.4 respectively.
- 7.6.2.1.2 Drums containing dangerous goods shall always be stowed in an upright position unless otherwise authorized by the competent authority.
- 7.6.2.1.3 The stowage of dangerous goods shall be so arranged as to ensure clear walkways and access to all facilities necessary for the safe working of the ship. When dangerous goods are stowed on deck, hydrants, sounding pipes and the like and access thereto shall be kept free and clear of such goods.
- 7.6.2.1.4 Fibreboard packagings, paper bags and other packages susceptible to water damage shall be stowed under deck or, if they are stowed on deck, they shall be so protected that at no time they are exposed to weather or to seawater.
- 7.6.2.1.5 Portable tanks shall not be overstowed by other cargo unless they are designed for that purpose or unless they are protected to the satisfaction of the competent authority.
- 7.6.2.1.6 Cargo spaces and decks shall be clean and dry as relevant to the hazards of the dangerous goods to be carried. In order to reduce the risk of ignition, the space shall be free of dust from other cargoes, such as grain or coal dust.
- 7.6.2.1.7 Packages and cargo transport units found to be damaged, leaking or sifting shall not be loaded on a general cargo ship. Care shall be taken to ensure that excessive water, snow, ice or foreign matter adhering to packages and cargo transport units shall be removed before loading.
- 7.6.2.1.8 Packages and cargo transport units and any other goods shall be adequately braced and secured for the voyage\*. Packages shall be loaded in such a way that there will be a minimum likelihood of damage to them and to any fittings during transport. Fittings on packages or portable tanks shall be adequately protected.

##### 7.6.2.2 Provisions for flammable gases and highly flammable liquids

- 7.6.2.2.1 In cargo ships of 500 gross tons or over and passengers ships constructed before 1st September 1984, and in cargo ships of less than 500 gross tons constructed before 1st February 1992, flammable gases or flammable liquids having a flashpoint of less than 23°C c.c., shall be stowed on deck only, unless otherwise approved by the Administration.
- 7.6.2.2.2 Flammable gases or liquids having a flashpoint less than 23°C c.c. transported on deck shall be stowed at least 3 m from any potential source of ignition.

\* Refer to regulation VII/5 of SOLAS 74 as amended.

## Part 7 – Provisions concerning transport operations

**7.6.2.3 Ventilation provisions**

7.6.2.3.1 In cargo ships of 500 gross tons or over and passenger ships constructed before 1st September 1984, and in cargo ships of less than 500 gross tons constructed before 1st February 1992, the following dangerous goods, may be stowed under deck only if the cargo space is equipped with mechanical ventilation and if under deck stowage is permitted in the Dangerous Goods List:

- dangerous goods of class 2.1;
- dangerous goods of class 3 with a flash point of less than 23°C c.c.;
- dangerous goods of class 4.3;
- dangerous goods of class 6.1 with a subsidiary risk of class 3;
- dangerous goods of class 8 with a subsidiary risk of class 3, and
- dangerous goods to which a specific stowage requirement requiring mechanical ventilation in column 16 of the Dangerous Goods List is assigned.

Otherwise containers shall be stowed on deck only.

7.6.2.3.2 The capacity of the mechanical ventilation (number of air changes per hour) shall be to the satisfaction of the Administration.

**7.6.2.4 Provisions for class 1**

7.6.2.4.1 All compartments or holds and cargo transport units shall be locked or suitably secured in order to prevent unauthorized access. The means of locking and securing shall be such that, in the case of emergency, access can be gained without delay.

7.6.2.4.2 Loading and unloading procedures and equipment used should be of such a nature that sparks are not produced, in particular where the floors of the cargo compartment are not constructed of close-boarded wood. All cargo handlers should be briefed by the shipper or receiver of the potential risks and necessary precautions, prior to commencing the handling of explosives. In the event of the contents of packages being affected by water whilst on board, immediate advice shall be sought from the shipper; pending this advice, handling of the packages shall be avoided.

**7.6.2.4.3 Segregation on deck**

When goods in different compatibility groups are transported on deck, they shall be stowed not less than 6 m apart unless their mixed stowage is allowed according to 7.2.7.

**7.6.2.4.4 Segregation in single hold ships**

In a single hold ship, dangerous goods of class 1 shall be segregated in accordance with 7.2.7 except that:

- .1 Goods in Division 1.1 or 1.2 of compatibility group B may be stowed in the same hold as substances of compatibility group D provided:
  - the net explosives mass of goods of compatibility group B does not exceed 50 kg; and
  - such goods are stowed in a closed cargo transport unit which is stowed at least 6 m from the substances of compatibility group D.
- .2 Goods in Division 1.4 of compatibility group B may be stowed in the same hold as substances of compatibility group D provided they are separated either by a distance of at least 6 m or by a steel division.

7.6.2.4.5 In the event that a package containing goods of class 1 is found to be suffering from breakage or leakage expert advice should be obtained for its safe handling and disposal.

**7.6.2.5 Provisions for class 2**

7.6.2.5.1 When pressure receptacles are stowed in a vertical position they shall be stowed in a block, cribbed or boxed-in with suitable sound lumber and the box or crib dunnaged to provide clearance from a steel deck. Pressure receptacles in a box or crib shall be braced to prevent any movement. The box or crib (gas rack) shall be securely chocked and lashed to prevent movement in any direction.

7.6.2.5.2 Pressure receptacles stowed on deck shall be protected from sources of heat.

**7.6.2.6 Provisions for class 3**

7.6.2.6.1 Class 3 substances with a flashpoint of less than 23°C c.c. packaged in jerricans, plastics (3H1, 3H2), drums, plastics (1H1, 1H2), plastics receptacles in a plastic drum (6HH1, 6HH2) and Plastic Intermediate Bulk Containers (IBCs 31H1 and 31H2), shall be stowed on deck only unless packed in a closed cargo transport unit.

- 7.6.2.6.2 Packages loaded on deck shall be protected from sources of heat.
- 7.6.2.7 Provisions for classes 4.1, 4.2 and 4.3
- 7.6.2.7.1 Packages stowed on deck shall be protected from sources of heat.
- 7.6.2.7.2 Stowage provisions for FISHMEAL, UNSTABILIZED (UN 1374), FISHMEAL, STABILIZED (UN 2216, class 9) and KRILL MEAL (UN3497)
- 7.6.2.7.2.1 For loose packagings:
- .1 Temperature readings shall be taken 3 times a day during the voyage and recorded.
  - .2 If the temperature of the cargo exceeds 55°C and continues to increase, ventilation to the hold shall be restricted. If self-heating continues, then carbon dioxide or inert gas shall be introduced. The ship shall be equipped with facilities for introducing carbon dioxide or inert gas into the holds.
  - .3 The cargo shall be stowed protected from sources of heat.
  - .4 For UN 1374 and 3497, where loose bags are being carried, double strip stowage is recommended, provided there is good surface and through ventilation. The diagram in 7.6.2.7.2.3 shows how this can be achieved. For UN 2216, where loose bags are being carried, no special ventilation is required for block stowage of bagged cargo.
- 7.6.2.7.2.2 For containers:
- .1 After packing, the doors and other openings shall be sealed to prevent the penetration of air into the unit.
  - .2 Temperature readings in the hold shall be taken once a day early in the morning during the voyage and recorded.
  - .3 If the temperature of the hold rises excessively above ambient and continues to increase, the possible need to apply copious quantities of water in an emergency and the consequent risk to the stability of the ship shall be considered.
  - .4 The cargo shall be stowed protected from sources of heat.
- 7.6.2.7.2.3

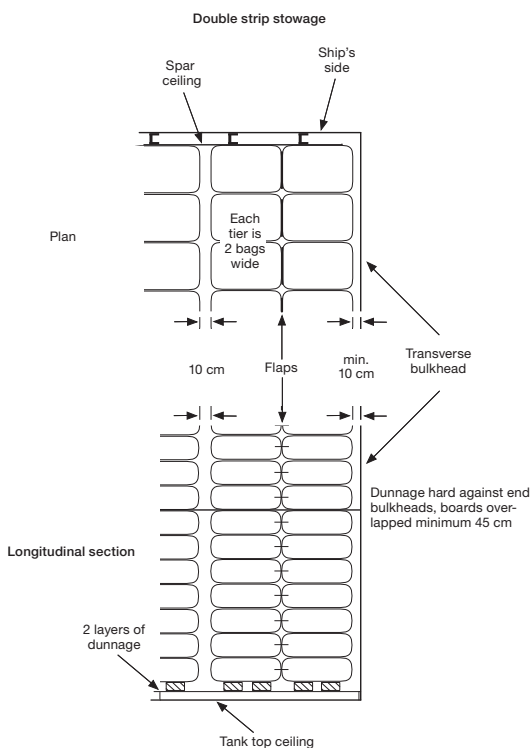

**Part 7 – Provisions concerning transport operations**

---

**7.6.2.7.3 Stowage provisions for SEED CAKE (UN 1386)**

**7.6.2.7.3.1** Stowage provisions for SEED CAKE, containing vegetable oil (a) mechanically expelled seeds, containing more than 10% oil or more than 20% oil and moisture combined:

- .1 through and surface ventilation is required;
- .2 if the voyage exceeds 5 days, the ship shall be equipped with facilities for introducing carbon dioxide or inert gas into the cargo spaces;
- .3 bags shall always be stowed in double strip, as shown in 7.6.2.7.2.3 of this Code for fishmeal, unstabilized; and
- .4 regular temperature readings shall be taken at varying depths in the cargo space and recorded. If the temperature of the cargo exceeds 55°C and continues to increase, ventilation to the cargo spaces shall be restricted. If self-heating continues, then carbon dioxide or inert gas shall be introduced.

**7.6.2.7.3.2** Stowage provisions for SEED CAKE, containing vegetable oil (b) solvent extractions and expelled seeds containing not more than 10% of oil and, when the amount of moisture is higher than 10%, not more than 20% of oil and moisture combined:

- .1 surface ventilation is required to assist in removing any residual solvent vapour;
- .2 if bags are stowed without provision for ventilation to circulate throughout the stow and the voyage exceeds 5 days, regular temperature readings shall be taken at varying depths in the hold and recorded; and
- .3 if the voyage exceeds 5 days, the vessel shall be equipped with facilities for introducing carbon dioxide or inert gas into the cargo spaces.

**7.6.2.8 Provisions for class 5.1**

**7.6.2.8.1** Cargo spaces shall be cleaned before oxidizing substances are loaded into them. All combustible materials which are not necessary for the stowage of such cargoes shall be removed from the hold.

**7.6.2.8.2** As far as reasonably practicable, non-combustible securing and protecting materials and only a minimum of clean dry wooden dunnage shall be used.

**7.6.2.8.3** Precautions shall be taken to avoid the penetration of oxidizing substances into other cargo spaces, bilges, etc., which may contain combustible material.

**7.6.2.8.4** UN 1942 AMMONIUM NITRATE and UN 2067 AMMONIUM NITRATE BASED FERTILIZER may be stowed under deck in a clean cargo space capable of being opened up in an emergency. The possible need to open hatches in case of fire to provide maximum ventilation and to apply water in an emergency and the consequent risk to the stability of the ship through flooding of cargo space shall be considered before loading.

**7.6.2.8.5** After discharge, cargo spaces used for the transport of oxidizing substances shall be inspected for contamination. A space that has been contaminated shall be properly cleaned and examined before being used for other cargoes.

**7.6.2.9 Provisions for self-reactive substances of class 4.1 and for class 5.2**

**7.6.2.9.1** Packages shall be stowed protected from sources of heat.

**7.6.2.9.2** When stowage arrangements are made, it shall be borne in mind that it may become appropriate to jettison a package or packages of this cargo.

**7.6.2.10 Provisions for classes 6.1 and 8**

**7.6.2.10.1** After discharge, spaces used for the transport of substances of this class shall be inspected for contamination. A space which has been contaminated shall be properly cleaned and examined before being used for other cargoes.

**7.6.2.10.2** Substances of class 8 shall be kept as dry as reasonably practicable, since in the presence of moisture they may be corrosive to most metals and some also react violently with water.

**7.6.2.11 Stowage of goods of class 9**

**7.6.2.11.1 Stowage provisions for AMMONIUM NITRATE BASED FERTILIZER , UN 2071**

**7.6.2.11.1.1** AMMONIUM NITRATE BASED FERTILIZER, UN 2071 shall be stowed in a clean cargo space capable of being opened up in an emergency. In the case of bagged fertilizer or fertilizer in containers or in bulk containers, it is sufficient if, in the case of an emergency, the cargo is accessible through free approaches (hatch entries), and mechanical ventilation enables the master to exhaust any gases or fumes resulting from decomposition.

The possible need to open hatches in case of fire to provide maximum ventilation and to apply water in an emergency, and the consequent risk to the stability of the ship through flooding of the cargo space, shall be considered before loading.

7.6.2.11.1.2 If suppression of decomposition should prove impracticable (such as in bad weather), there would not necessarily be immediate danger to the structure of the ship. However, the residue left after decomposition may have only half the mass of the original cargo; this loss of mass may also affect the stability of the ship and shall be considered before loading.

7.6.2.11.1.3 AMMONIUM NITRATE BASED FERTILIZER, UN 2071 shall be stowed out of direct contact with a metal engine-room bulkhead. In the case of bagged material, this may be done, for example, by using wooden boards to provide an air space between the bulkhead and the cargo. This requirement need not apply to short international voyages.

7.6.2.11.1.4 In the case of ships not fitted with smoke-detecting or other suitable devices, arrangements shall be made during the voyage to inspect cargo spaces containing these fertilizers at intervals not exceeding 4 hours (such as to sniff at the ventilators serving them) to ensure early detection of decomposition should that occur.

7.6.2.11.2 *Stowage provisions for FISHMEAL, STABILIZED (UN 2216, class 9)*

7.6.2.11.2.1 For stowage provisions for FISHMEAL, STABILIZED (UN 2216, class 9), see 7.6.2.7.2.

7.6.2.12 **Stowage of dangerous goods in flexible bulk containers**

7.6.2.12.1 The stowage of dangerous goods in flexible bulk containers is not permitted on deck.

7.6.2.12.2 Flexible bulk containers shall be stowed in such way that there are no void spaces between flexible bulk containers in the hold. If the flexible bulk containers do not completely fill the hold, adequate measures shall be taken to avoid shifting of cargo.

7.6.2.12.3 The maximum permissible stacking height of flexible bulk containers shall never exceed 3 high.

7.6.2.12.4 When flexible bulk containers are fitted with venting devices, the stowage of the flexible bulk containers shall not impede their function.

7.6.3 **Segregation provisions**

7.6.3.1 **Segregation from foodstuffs**

7.6.3.1.1 For the purpose of this subsection, the terms “away from”, “separated from” and “separated by a complete compartment or hold from” are defined in 7.6.3.2.

7.6.3.1.2 Dangerous goods having a primary or subsidiary risk of classes 2.3, 6.1, 7 (with the exception of UN 2908, 2909, 2910 and 2911), 8 and dangerous goods having a reference to 7.6.3.1.2 in column 16 of the Dangerous Goods List stowed in a conventional way shall be “separated from” foodstuffs stowed in a conventional way. If either dangerous goods or foodstuffs are in a closed cargo transport unit, dangerous goods shall be stowed “away from” foodstuffs. If both dangerous goods and foodstuffs are in different closed cargo transport units, no segregation requirements shall apply.

7.6.3.1.3 Dangerous goods of class 6.2 stowed in a conventional way shall be “separated by a complete compartment or hold from” foodstuffs stowed in a conventional way. If either dangerous goods or foodstuffs are in a closed cargo transport unit, dangerous goods shall be stowed “separated from” foodstuffs.

Part 7 – Provisions concerning transport operations

7.6.3.2 Segregation of packages containing dangerous goods and stowed in the conventional way

Definitions of the segregation terms

Away from:

Effectively segregated so that the incompatible goods cannot interact dangerously in the event of an accident but may be transported in the same compartment or hold or *on deck*, provided a minimum horizontal separation of 3 metres, projected vertically is obtained.

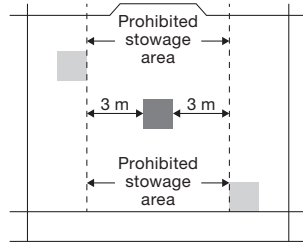

Separated from:

In different compartments or holds when stowed *under deck*. Provided the intervening deck is resistant to fire and liquid, a vertical separation, i.e. in different compartments, may be accepted as equivalent to this segregation. For *on deck* stowage, this segregation means a separation by a distance of at least 6 metres horizontally.

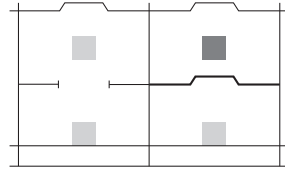

Separated by a complete compartment or hold from:

Either a vertical or a horizontal separation. If the intervening decks are not resistant to fire and liquid, then only a longitudinal separation, i.e. by an intervening complete compartment or hold, is acceptable. For *on deck* stowage, this segregation means a separation by a distance of at least 12 metres horizontally. The same distance has to be applied if one package is stowed on deck, and the other one in an upper compartment.

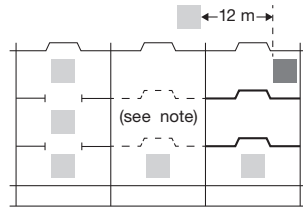

Note: One of the two decks must be resistant to fire and to liquid

Separated longitudinally by an intervening complete compartment or hold from:

Vertical separation alone does not meet this requirement. Between a package *under deck* and one on deck, a minimum distance of 24 m, including a complete compartment, must be maintained longitudinally. For *on deck* stowage, this segregation means a separation by a distance of at least 24 metres longitudinally.

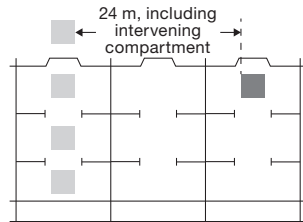

Legend

- (1) Reference package. ....
- (2) Package containing incompatible goods. ....
- (3) Deck resistant to fire and liquid. ....

Note: Vertical lines represent transverse watertight bulkheads between cargo spaces.

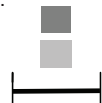

- 7.6.3.3 Segregation of dangerous goods stowed in the conventional way from those transported in cargo transport units**
- 7.6.3.3.1** Dangerous goods stowed in the conventional way shall be segregated from goods transported in open cargo transport units in accordance with 7.6.3.2.
- 7.6.3.3.2** Dangerous goods stowed in the conventional way shall be segregated from goods transported in closed cargo transport units in accordance with 7.6.3.2 except that:
- .1 where "away from" is required, no segregation between the packages and the closed cargo transport units is required; and
  - .2 where "separated from" is required, the segregation between the packages and the closed cargo transport units may be as for "away from" as defined in 7.6.3.2.
- 7.6.3.4 Segregation of dangerous goods in cargo transport units stowed in conventional cargo spaces**
- 7.6.3.4.1** Dangerous goods in different closed cargo transport units (closed freight containers) stowed in holds and compartments not properly fitted to give a permanent stowage of the containers during transport shall be segregated from each other in accordance with 7.6.3.2 except that:
- .1 where "away from" is required, no segregation between the closed cargo transport units is required; and
  - .2 where "separated from" is required, the segregation between the closed cargo transport units may be as for "away from" as defined in 7.6.3.2.
- 7.6.3.5 Segregation between bulk materials possessing chemical hazards and dangerous goods in packaged form**
- 7.6.3.5.1** Unless otherwise required in this Code or in the IMSBC Code, segregation between bulk materials possessing chemical hazards and dangerous goods in packaged form shall be in accordance with the following table.
- 7.6.3.5.2 Segregation table**

Bulk materials (classified as dangerous goods)	Dangerous goods in packaged form																
	CLASS	1.1 1.2 1.5	1.3 1.6	1.4	2.1	2.2 2.3	3	4.1	4.2	4.3	5.1	5.2	6.1	6.2	7	8	9
Flammable solids	4.1	4	3	2	2	2	2	X	1	X	1	2	X	3	2	1	X
Substances liable to spontaneous combustion	4.2	4	3	2	2	2	2	1	X	1	2	2	1	3	2	1	X
Substances which, in contact with water, emit flammable gases	4.3	4	4	2	1	X	2	X	1	X	2	2	X	2	2	1	X
Oxidizing substances (agents)	5.1	4	4	2	2	X	2	1	2	2	X	2	1	3	1	2	X
Toxic substances	6.1	2	2	X	X	X	X	X	1	X	1	1	X	1	X	X	X
Radioactive material	7	2	2	2	2	2	2	2	2	2	1	2	X	3	X	2	X
Corrosive substance	8	4	2	2	1	X	1	1	1	1	2	2	X	3	2	X	X
Miscellaneous dangerous substances and articles	9	X	X	X	X	X	X	X	X	X	X	X	X	X	X	X	X
Materials hazardous only in bulk (MHB)		X	X	X	X	X	X	X	X	X	X	X	X	3	X	X	X

Numbers and symbols relate to the following terms, as defined in this chapter:

- 1 – "Away from"
- 2 – "Separated from"
- 3 – "Separated by a complete compartment or hold from"
- 4 – "Separated longitudinally by an intervening complete compartment or hold from"
- X – The segregation, if any, is shown in the Dangerous Goods List in this Code or the individual entries in the IMSBC Code.

Part 7 – Provisions concerning transport operations

7.6.3.5.3 Definitions of the segregation terms

*Away from:*

Effectively segregated so that incompatible materials cannot interact dangerously in the event of an accident but may be transported in the same compartment or hold or *on deck* provided a minimum horizontal separation of 3 m, projected vertically, is provided.

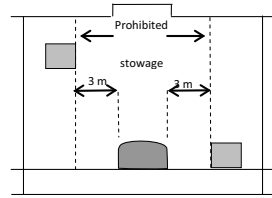

*Separated from:*

In different holds when stowed *under deck*. Provided an intervening deck is resistant to fire and liquid, a vertical separation, i.e. in different compartments, may be accepted as equivalent to this segregation.

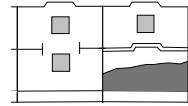

*Separated by a complete compartment or hold from:*

Either a vertical or a horizontal separation. If the decks are not resistant to fire and liquid, then only a longitudinal separation, i.e. by an intervening complete compartment, is acceptable.

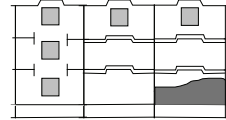

*Separated longitudinally by an intervening complete compartment or hold from:*

Vertical separation alone does not meet this requirement.

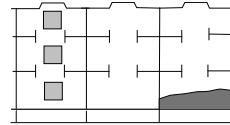

*Legend*

- (1) Reference bulk material . . . . .
- (2) Package containing incompatible. . . . .
- (3) Deck resistant to fire and liquid . . . . .

**Note:** Vertical lines represent transverse watertight bulkheads between cargo spaces.



## Chapter 7.7

### *Shipborne barges on barge-carrying ships*

#### 7.7.1 Introduction

7.7.1.1 The provisions of this chapter are applicable to shipborne barges which contain packaged dangerous goods or solid bulk materials possessing chemical hazards while aboard barge carrying ships.

7.7.1.2 Barges used for the shipborne transport of packaged dangerous goods or solid bulk materials possessing chemical hazards shall be of proper design and adequate strength to resist the stresses imposed by the conditions of the services in which they are employed and they shall be adequately maintained. Shipborne barges shall be approved in accordance with provisions for certification of a recognized classification society, or any organization approved by and acting on behalf of the competent authority of the countries concerned.

#### 7.7.2 Definitions

7.7.2.1 *Loading*, for the purpose of this chapter, means the placement of cargo into a shipborne barge.

7.7.2.2 *Stowage*, for the purposes of this chapter, means the placement of a shipborne barge aboard the barge carrying ship.

#### 7.7.3 Barge loading

7.7.3.1 Packages shall be examined and any found to be damaged, leaking or sifting shall not be loaded into a shipborne barge. Care shall be taken to ensure that excessive water, snow, ice or foreign matter adhering to packages shall be removed before loading into a shipborne barge.

7.7.3.2 Packages containing dangerous goods, cargo transport units and any other goods within a shipborne barge shall be adequately braced and secured for the voyage. Packages shall be loaded in such a way that there will be a minimum likelihood of damage to them and to any fittings during transport. Fittings on packages or portable tanks shall be adequately protected.

7.7.3.3 Certain dry dangerous goods may be transported in bulk in shipborne barges; this is indicated by the Code "BK2" in column 13 of the Dangerous Goods List. Where such solid bulk materials possessing chemical hazards are transported in shipborne barges, it shall be ensured that at all times the cargo is evenly distributed, properly trimmed and secured.

7.7.3.4 Shipborne barges into which packaged dangerous goods or solid bulk materials possessing chemical hazards are to be loaded shall be examined visually for hull or hatch cover damage which could impair watertight integrity. If there is evidence of such damage, the shipborne barge may not be used for the transport of packaged dangerous goods or solid bulk materials possessing chemical hazards and shall not be loaded.

7.7.3.5 Dangerous goods which have to be segregated from each other according to the provisions in chapter 7.2 shall not be transported in the same barge with the exception of dangerous goods which shall be segregated "away from" each other which may be transported in the same barge with the approval of the competent authority. In such cases an equivalent standard of safety shall be maintained.

7.7.3.6 Dangerous goods having a primary or subsidiary risk of classes 2.3, 6.1, 6.2, 7 (with the exception of UN 2908, 2909, 2910 and 2911), 8 and dangerous goods having a reference to 7.7.3.6 in column 16 of the Dangerous Goods List shall not be transported together with foodstuffs (see 1.2.1) in the same barge.

7.7.3.7 Notwithstanding the provisions in 7.7.3.6, the following dangerous goods may be transported with foodstuffs in the same barge provided that they are not loaded within 3 m from foodstuffs:

- .1 dangerous goods of packing group III of classes 6.1 and 8;
- .2 dangerous goods of packing group II of class 8;
- .3 any other dangerous goods of packing group III with a subsidiary risk of classes 6.1 or 8; and
- .4 dangerous goods having a reference to 7.7.3.7 in column 16 of the Dangerous Goods List.

## Part 7 – Provisions concerning transport operations

- 7.7.3.8 Shipborne barges containing a residue of a dangerous cargo or shipborne barges loaded with empty packagings still containing a residue of a dangerous substance shall comply with the same provisions as barges loaded with the substance itself.
- 7.7.3.9 **Stowage of dangerous goods in flexible bulk containers**
- 7.7.3.9.1 Flexible bulk containers shall be stowed in the barge in such way that there are no void spaces between the flexible bulk containers in the barge. If the flexible bulk containers do not completely fill the barge, adequate measures shall be taken to avoid shifting of cargo.
- 7.7.3.9.2 The maximum permissible height of the stack of the flexible bulk containers shall never exceed 3 high.
- 7.7.3.9.3 When flexible bulk containers are fitted with venting devices, the stowage of the flexible bulk containers in their barge shall not impede their function.
- 7.7.4 **Stowage of shipborne barges**
- 7.7.4.1 Stowage of shipborne barges carrying packaged dangerous goods or solid bulk materials possessing chemical hazards aboard barge carrying ships shall be as required for the substance in chapter 7.1 and in column 16 of the Dangerous Goods List. When a shipborne barge is loaded with more than one substance, and the stowage locations differ for the substances (i.e. some substances require on deck stowage while other substances require under deck stowage), the shipborne barge containing these substances shall be stowed on deck.
- 7.7.4.2 Provision shall be made to ensure that shipborne barges stowed under deck and loaded with cargoes requiring ventilation because of their dangerous nature are ventilated to the extent necessary.
- 7.7.4.3 Where it is required that a dangerous good shall be protected from sources of heat, this provision shall be applied to the shipborne barge as a whole, unless suitable alternative measures are provided.
- 7.7.4.4 When packaged dangerous goods or solid bulk materials possessing chemical hazards are loaded in shipborne barges aboard barge carrying ships having the capability of providing fixed fire fighting systems or fire detection systems to individual barges, care shall be taken to ensure that these systems are attached to the shipborne barge and operating properly.
- 7.7.4.5 When packaged dangerous goods or solid bulk materials possessing chemical hazards are loaded in shipborne barges aboard barge carrying ships having fixed fire fighting systems or fire detection systems installed in individual barge holds, care shall be taken to ensure that the ventilation closures on the shipborne barges are open, to permit the fire fighting medium to enter the barges in case of fire.
- 7.7.4.6 When ventilation ducts are provided to individual shipborne barges, the ventilation fans shall be secured when fire fighting medium is introduced into the hold to permit the medium to enter the shipborne barges.
- 7.7.5 **Segregation between barges on board barge carrying ships**
- 7.7.5.1 For barge carrying ships which incorporate other cargo spaces or any other method of stowage, the appropriate chapter shall apply to the relevant cargo space.
- 7.7.5.2 When a shipborne barge is loaded with two or more substances with different provisions for segregation, the most stringent segregation applicable shall be applied.
- 7.7.5.3 “Away from” and “separated from” require no segregation between shipborne barges.
- 7.7.5.4 “Separated by a complete compartment or hold from” means, for barge carrying ships with vertical holds, that separate holds are required. On barge carrying ships having horizontal barge levels, separate barge levels are required and the barges shall not be in the same vertical line.
- 7.7.5.5 “Separated longitudinally by an intervening complete compartment or hold from” means, for barge carrying ships with vertical holds, that separation by an intervening hold or engine room is required. On barge carrying ships having horizontal barge levels, separate barge levels and a longitudinal separation by at least two intervening barge spaces is required.

## Chapter 7.8

### *Special requirements in the event of an incident and fire precautions involving dangerous goods*

**Note:** The provisions of this chapter are not mandatory.

#### **7.8.1 General**

- 7.8.1.1** In the event of an incident involving dangerous goods, detailed recommendations are contained in The EmS Guide: Emergency Response Procedures for Ships Carrying Dangerous Goods.
- 7.8.1.2** In the event of personnel exposure during an incident involving dangerous goods, detailed recommendations are contained in Medical First Aid Guide for Use in Accidents Involving Dangerous Goods (MFAAG).
- 7.8.1.3** In the event that a package containing dangerous goods is found to be suffering from breakage or leakage while the ship is in port, the port authorities should be informed and appropriate procedures should be followed.

#### **7.8.2 General provisions in the event of incidents**

- 7.8.2.1** Recommendations on emergency action may differ depending on whether or not the goods are stowed on deck or under deck or whether a substance is gaseous, liquid or solid. When dealing with incidents involving flammable gases, or flammable liquids with a flashpoint of 60°C closed-cup (c.c.) or below, all sources of ignition (such as naked lights, unprotected light bulbs, electric handtools) should be avoided.
- 7.8.2.2** In general, the recommendation is to wash spillages on deck overboard with copious quantities of water and, where there is likely to be a dangerous reaction with water, from as far away as practicable. Disposal of spilt dangerous goods overboard is a matter for judgement by the master, bearing in mind that the safety of the crew has priority over pollution of the sea. If it is safe to do so, spillages and leakages of substances, articles and materials identified in this Code as MARINE POLLUTANT should be collected for safe disposal. Inert absorbent material should be used for liquids.
- 7.8.2.3** Toxic, corrosive and/or flammable vapours in under deck cargo spaces should, where possible, be dispersed before undertaking any emergency action. Where a mechanical ventilation system is used, care will be necessary to ensure that flammable vapours are not ignited.
- 7.8.2.4** If there is any reason to suspect leakage of these substances, entry into a hold or cargo space should not be permitted until the master or responsible officer has taken all safety considerations into account and is satisfied that it is safe to do so.
- 7.8.2.5** Emergency entry into the hold under other circumstances should only be undertaken by trained crew wearing self-contained breathing apparatus and other protective clothing.
- 7.3.2.6** A careful inspection for structural damage should be carried out after dealing with spillages of substances corrosive to steel and cryogenic liquids.

#### **7.8.3 Special provisions for incidents involving infectious substances**

- 7.8.3.1** If any person responsible for the transport or opening of packages containing infectious substances becomes aware of damage to or leakage from such packages, he should:
- .1 avoid handling the package or keep handling to a minimum;
  - .2 inspect adjacent packages for contamination and put aside any that have been contaminated;
  - .3 inform the appropriate public health authority or veterinary authority, and provide information on any other countries of transit where persons may have been exposed to danger; and
  - .4 notify the consignor and/or the consignee.

## Part 7 – Provisions concerning transport operations

**7.8.3.2 Decontamination**

A cargo transport unit, a bulk container or a cargo space of a ship, which has been used to transport infectious substances, shall be inspected for release of the substance before re-use. If infectious substances were released during transport, the cargo transport unit, the bulk container or the cargo space of a ship shall be decontaminated before it is re-used. Decontamination may be achieved by any means which effectively inactivates the infectious substance released.

**7.8.4 Special provisions for incidents involving radioactive material**

**7.8.4.1** If it is evident that a package is damaged or leaking, or if it is suspected that the package may have leaked or been damaged, access to the package should be restricted and a qualified person should, as soon as possible, assess the extent of contamination and the resultant radiation level of the package. The scope of the assessment should include the package, the conveyance, the adjacent loading and unloading areas, and, if necessary, all other material which has been transported in the conveyance. When necessary, additional steps for the protection of persons, property and the environment, in accordance with provisions established by the relevant competent authority, should be taken to overcome and minimize the consequences of such leakage or damage.

**7.8.4.2** Packages damaged or leaking radioactive contents in excess of allowable limits for normal conditions of transport may be removed to an acceptable interim location under supervision, but should not be forwarded until repaired or reconditioned and decontaminated.

**7.8.4.3** In the event of accidents or incidents during the transport of radioactive material, emergency provisions, as established by relevant national and/or international organizations, should be observed to protect persons, property and the environment. Appropriate guidelines for such provisions are contained in the International Atomic Energy Agency's document "Planning and Preparing for Emergency Response to Transport Accidents Involving Radioactive Material", Safety Standard Series No. TS-G-1.2 (ST-3), IAEA, Vienna (2002).

**7.8.4.4** Attention is drawn to the latest versions of both The EmS Guide: Emergency Response Procedures for Ships Carrying Dangerous Goods and the Medical First Aid Guide for Use in Accidents Involving Dangerous Goods (MFAG).

**7.8.4.5** Emergency response procedures should take into account the formation of other dangerous substances that may result from the reaction between the contents of a consignment and the environment in the event of an accident.

**7.8.4.6** In the event of a package containing radioactive material suffering from breakage or leakage while the ship is in port, the port authorities should be informed and advice obtained from them or from the competent authority<sup>8</sup>. Procedures have been drawn up in many countries for summoning radiological assistance in any such emergency.

**7.8.5 General fire precautions**

**7.8.5.1** The prevention of fire in a cargo of dangerous goods is achieved by practising good seamanship, observing in particular the following precautions:

- .1 keep combustible material away from ignition sources;
- .2 protect a flammable substance by adequate packing;
- .3 reject damaged or leaking packages;
- .4 stow packages protected from accidental damage or heating;
- .5 segregate packages from substances liable to start or spread fire;
- .6 where appropriate and practicable, stow dangerous goods in an accessible position so that packages in the vicinity of a fire may be protected;
- .7 enforce prohibition of smoking in dangerous areas and display clearly recognizable "NO SMOKING" notices or signs; and
- .8 the dangers from short-circuits, earth leakages or sparking will be apparent. Lighting and power cables and fittings should be maintained in good condition. Cables or equipment found to be unsafe should be disconnected. Where a bulkhead is required to be suitable for segregation purposes, cables and conduit penetrations of the decks and bulkheads should be sealed against the passage of gas and vapours.

<sup>8</sup> Reference is made to chapter 7.9 and the IAEA list of national competent authorities responsible for approvals and authorizations in respect of the transport of radioactive material. The list is updated annually.

When stowing dangerous goods on deck, the position and design of auxiliary machinery, electrical equipment and cable runs should be considered in order to avoid sources of ignition.

7.8.5.2 Fire precautions applying to individual classes, and where necessary to individual substances, are recommended in 7.8.2 and 7.8.6 to 7.8.9 and in the Dangerous Goods List.

## **7.8.6 Special fire precautions for class 1**

### **7.8.6.1**

- .1 The greatest risk in the handling and transport of goods of class 1 is that of fire from a source external to the goods, and it is vital that any fire should be detected and extinguished before it can reach such goods. Consequently, it is essential that fire precautions, fire-fighting measures and equipment are of a high standard and ready for immediate application and use.
- .2 Compartments containing goods of class 1 and adjacent cargo spaces should be provided with a fire-detection system. If such spaces are not protected by a fixed fire-extinguishing system, they should be accessible for fire-fighting operations.
- .3 No repair work should be carried out in a compartment containing goods of class 1. Special care should be exercised in carrying out repairs in any adjacent space. No welding, burning, cutting, or riveting operations involving the use of fire, flame, spark, or arc-producing equipment should be carried out in any space other than machinery spaces and workshops where fire-extinguishing arrangements are available, except in any emergency and, if in port, with prior authorization of the port authority.

## **7.8.7 Special fire precautions for class 2**

7.8.7.1 Effective ventilation should be provided to remove any leakage of gas from within the cargo space or spaces, bearing in mind that some gases are heavier than air and may accumulate in dangerous concentrations in the lower part of the ship.

7.8.7.2 Measures should be taken to prevent leaking gases from penetrating into any other part of the ship.

### **7.8.7.3**

- .1 If there is any reason to suspect leakage of a gas, entry into cargo spaces or other enclosed spaces should not be permitted until the master or responsible officer has taken all safety considerations into account and is satisfied that it is safe to do so. Emergency entry under other circumstances should only be undertaken by trained crew wearing self-contained breathing apparatus, and protective clothing when recommended, and always under the supervision of a responsible officer.
- .2 Leakage from pressure receptacles containing flammable gases may give rise to explosive mixtures with air. Such mixtures, if ignited, may result in explosion and fire.

## **7.8.8 Special fire precautions for class 3**

7.8.8.1 Flammable liquids give off flammable vapours which, especially in an enclosed space, form explosive mixtures with air. Such vapours, if ignited, may cause a “flashback” to the place in which the substances are stowed. Due regard should be paid to the provision of adequate ventilation to prevent accumulation of vapours.

## **7.8.9 Special fire precautions and fire fighting for class 7**

7.8.9.1 The radioactive contents of Excepted, Industrial, and Type A packages are so restricted that, in the event of an accident and damage to the package, there is a high probability that any material released, or shielding efficiency lost, would not give rise to such radiological hazard as to hamper fire-fighting or rescue operations.

7.8.9.2 Type B(U) packages, Type B(M) packages and Type C packages are designed to be strong enough to withstand severe fire without significant loss of contents or dangerous loss of radiation shielding.

## Chapter 7.9

### *Exemptions, approvals and certificates*

---

#### 7.9.1 Exemptions

**Note 1** The provisions of this section do not apply to exemptions mentioned in chapters 1 to 7.8 of this Code and to approvals (including permits, authorizations or agreements) and certificates which are referred to in chapters 1 to 7.8 of this Code. For the said approvals and certificates, see 7.9.2.

**Note 2** The provisions of this section do not apply to class 7. For consignments of radioactive material for which conformity with any provision of this Code applicable to class 7 is impracticable, refer to 1.5.4.

**7.9.1.1** Where this Code requires that a particular provision for the transport of dangerous goods shall be complied with, a competent authority or competent authorities (port State of departure, port State of arrival or flag State) may authorize any other provision by exemption if satisfied that such provision is at least as effective and safe as that required by this Code. Acceptance of an exemption authorized under this section by a competent authority not party to it is subject to the discretion of that competent authority. Accordingly, prior to any shipment covered by the exemption, the recipient of the exemption shall notify other competent authorities concerned.

**7.9.1.2** Competent authority or competent authorities which have taken the initiative with respect to the exemption:  
.1 shall send a copy of such exemption to the International Maritime Organization which shall bring it to the attention of the Contracting Parties to SOLAS and/or MARPOL, as appropriate, and  
.2 if appropriate, take action to amend the IMDG Code to include the provisions covered by the exemption.

**7.9.1.3** The period of validity of the exemption shall be not more than five years from the date of authorization. An exemption that is not covered under 7.9.1.2.2 may be renewed in accordance with the provisions of this section.

**7.9.1.4** A copy of the exemption shall accompany each consignment when offered to the carrier for transport under the terms of the exemption. A copy of the exemption or an electronic copy thereof shall be maintained on board each ship transporting dangerous goods in accordance with the exemption, as appropriate.

#### 7.9.2 Approvals (including permits, authorizations or agreements) and certificates

**7.9.2.1** Approvals, including permits, authorizations or agreements, and certificates referred to in chapters 1 to 7.8 of this Code and issued by the competent authority (authorities when the Code requires a multilateral approval) or a body authorized by that competent authority (e.g. approvals for alternative packaging in 4.1.3.7, approval for segregation as in 7.3.4.1 or certificates for portable tanks in 6.7.2.18.1) shall be recognized, as appropriate:

- .1 by other contracting parties to SOLAS if they comply with the requirements of the International Convention for the Safety of Life at Sea (SOLAS), 1974, as amended; and/or
- .2 by other contracting parties to MARPOL if they comply with the requirements of the International Convention for the Prevention of Pollution from Ships, 1973, as modified by the Protocol of 1978 relating thereto (MARPOL 73/78, Annex III), as amended.

#### 7.9.3 Contact information for the main designated national competent authorities

Contact information for the main designated national competent authorities concerned is given in this paragraph\*. Corrections to these addresses should be sent to the Organization†.

---

\* Reference is made to MSC.1/Circ.1410, as may be amended, which provides a more comprehensive listing of contact information for competent authorities and bodies.

† International Maritime Organization  
4 Albert Embankment  
London SE1 7SR  
United Kingdom  
Email: info@imo.org  
Fax: +44 207587 3120

LIST OF CONTACT INFORMATION FOR THE MAIN  
DESIGNATED NATIONAL COMPETENT AUTHORITIES

Country	Contact information for the main designated national competent authority
<b>ALGERIA</b>	Ministère des Transports/Direction de la Marine Marchande 119 Rue Didouche Mourad Alger ALGÉRIE Telephone: +213 26061 46 Telex: 66063 DGAF DZ
<b>AMERICAN SAMOA</b>	Silila Patane Harbour Master Port Administration Pagopago American Samoa AMERICAN SAMOA 96799
<b>ANGOLA</b>	National Director Marine Safety, Shipping and Ports National Directorate of Merchant Marine and Ports Rua Rainha Ginga 74, 4 Andar Luanda ANGOLA Telephone: +244 239 0034/397 984 Fax: +244 231 0375 Mobile: +244 924 393 36 Email: ispscode_angola@snet.co.ao
<b>ARGENTINA</b>	Prefectura Naval Argentina (Argentine Coast Guard) Dirección de protección ambiental Departamento de protección ambiental y mercancías peligrosas División mercancías y residuos peligrosos Avda. Eduardo Madero 235 4° piso, Oficina 4.36 y 4.37 Buenos Aires (C1106ACC) REPÚBLICA ARGENTINA Telephone: +54 11 4318 7669 Fax: +54 11 4318 7474 Email: dpma-mp@prefecturanaval.gov.ar
<b>AUSTRALIA</b>	Manager, Ship Inspection Maritime Operations Australian Maritime Safety Authority GPO Box 2181 Canberra ACT 2601 AUSTRALIA Telephone: +61 2 6279 5048 Fax: +61 2 6279 5058 Email: psc@amsa.gov.au Website: www.amsa.gov.au
<b>BAHAMAS</b>	The Director Bahamas Maritime Authority 120 Old Broad Street London, EC2N 1AR UNITED KINGDOM Telephone: +44 (0)20 7562 1300 Fax: +44 (0)20 7614 0650 Email: tech@bahamasmaritime.com Website: www.bahamasmaritime.com

Part 7 – Provisions concerning transport operations

Country	Contact information for the main designated national competent authority
BARBADOS	Director of Maritime Affairs Ministry of Tourism and International Transport 2nd Floor, Carlisle House Hincks Street Bridgetown St. Michael BARBADOS Telephone: +1 246 426 2710/3342 Fax: +1 246 426 7882 Email: ctech@sunbeach.net
BELGIUM	<p><i>Brussels office</i>                      Federal Public Service Mobility and Transport                      Directorate-General Maritime Transport                      Rue de Progrès 56                      B-1210 Brussels                      BELGIUM                      Telephone: +32 2 277 3500                      Fax: +32 2 277 4051                      Email: dg.mar@mobilit.fgov.be                      Website: www.mobilit.fgov.be</p> <p><i>Antwerp office</i>                      Federale Overheidsdienst Mobiliteit en Vervoer                      Directoraat-generaal Maritiem Vervoer                      Scheepvaartcontrole                      Loodsgebouw                      Tavernierkaai 3                      B-2000 Antwerpen                      BELGIUM                      Telephone: +32 3 229 0030                      Fax: +32 3 229 0031                      Email: hazmat.antwerpen@mobilit.fgov.be</p> <p><i>Ostend office</i>                      Federale Overheidsdienst Mobiliteit en Vervoer                      Directoraat-generaal Maritiem Vervoer                      Scheepvaartcontrole                      Natiënkaai 5                      B-8400 Oostende                      BELGIUM                      Telephone: +32 59 56 1450                      Fax: +32 59 56 1474                      Email: hazmat.zeebrugge@mobilit.fgov.be</p>
BELIZE	Ports Commissioner Belize Port Authority P.O. Box 633 Belize City BELIZE, C.A. Telephone: +501 227 2540/0981 Fax: +501 227 2500
BRAZIL	Diretoria de Portos e Costas (DPC-20) Rua Teófilo Otoni No. 04 Centro Rio de Janeiro CEP 20090-070 BRAZIL Telephone: +55 21 2104 5203 Fax: +55 21 2104 5202 Email: secom@dpc.mar.mil.br



Country	Contact information for the main designated national competent authority
BULGARIA	<p><i>Head office</i>            Captain Petar Petrov, Director            Directorate “Quality Management”            Bulgarian Maritime Administration            9 Dyakon Ignatii Str.            Sofia 1000            REPUBLIC OF BULGARIA            Telephone: +359 2 93 00 910/912            Fax: +359 2 93 00 920            Email: bma@marad.bg                      petrov@marad.bg</p> <p><i>Regional offices</i>            Harbour-Master            Directorate            “Maritime Administration” – Bourgas            3 Kniaz Alexander Batemberg Str.            Bourgas 8000            REPUBLIC OF BULGARIA            Telephone: +359 56 875 775            Fax: +359 56 840 064            Email: hm_bs@marad.bg</p> <p>Harbour-Master            Directorate            “Maritime Administration” – Varna            5 Primorski Bvd            Varna 9000            REPUBLIC OF BULGARIA            Telephone: +359 52 684 922            Fax: +359 52 602 378            Email: hm_vn@marad.bg</p>
BURUNDI	<p>Minister            Ministère des Transports, Postes et Télécommunications            B.P. 2000            Bujumbura            BURUNDI            Telephone: +257 219 324            Fax: +257 217 773</p>
CANADA	<p>The Chairman            Marine Technical Review Board            Director, Operations and Environmental Programs            Marine Safety – Transport Canada            Tower C, Place de Ville            330 Sparks Street, 10th Floor            Ottawa, Ontario            K1A 0N5            CANADA            Telephone: +1 613 991 3132                              +1 613 991 3143                              +1 613 991 3139/40            Fax: +1 613 993 8196</p>



Country	Contact information for the main designated national competent authority
<p><b>CROATIA</b> (continued)</p>	<p><i>Testing and certification of packagings</i> Adriainspekt Ciottina 17/b 51000 Rijeka REPUBLIC OF CROATIA Telephone: +385 51 511 133 Fax: +385 51 36 176</p> <p><i>Classification society for CSC containers (including IMO tanks)</i> Croatian Register of Shipping Marasoviceva 67 21000 Split REPUBLIC OF CROATIA Telephone: +385 21 358 933 Fax: +385 21 358 159</p>
<p><b>CUBA</b></p>	<p>Ministerio del Transporte Dirección de Seguridad e Inspección Marítima Boyeros y Tulipán Plaza Ciudad de la Habana CUBA Telephone: +53 7 881 6607 +53 7 881 9498 Fax: +53 7 881 1514 Email: dsim@mitrans.transnet.cu</p>
<p><b>CYPRUS</b></p>	<p>Department of Merchant Shipping Ministry of Communications and Works Kylinis Street Mesa Geitonia CY-4007 Lemesos P.O. Box 56193 CY-3305 Lemesos CYPRUS Telephone: +357 5 848 100 Fax: +357 5 848 200 Telex: 2004 MERSHIP CY Email: dms@cytanet.com.cy</p>
<p><b>CZECH REPUBLIC</b></p>	<p><i>Implementation</i> Ministry of Transport of the Czech Republic Navigation Department Nábr. L. Svobody 12 110 15 Praha 1 CZECH REPUBLIC Telephone: +420 225 131 151 Fax: +420 225 131 110 Email: sekretariat.230@mocr.cz</p> <p><i>Packaging, testing and certification</i> CIMTO, s.p. Un Michelského lesa 336 146 23 Praha 4 CZECH REPUBLIC Telephone: +42 2 472 94 64 Fax: +42 2 472 36 76</p> <p>IMET, s.r.o. Bažantní 697 165 00 Praha 6 CZECH REPUBLIC Telephone: +42 2 39 32 96 Fax: +42 2 29 23 70</p>

Part 7 – Provisions concerning transport operations

Country	Contact information for the main designated national competent authority
<p><b>CZECH REPUBLIC</b> (continued)</p>	<p><i>Classification of dangerous goods of all classes, except class 7 – radioactive materials</i> Český lodní a průmyslový registr, s.r.o. (Czech Shipping and Industry Register, Ltd.) Jankovcova 10 170 00 Praha 7 CZECH REPUBLIC Telephone: +42 2 667 10001 Fax: +42 2 808 984 Telex: +42 2 122 874 csir c</p>
<p><b>DEMOCRATIC PEOPLE'S REPUBLIC OF KOREA</b></p>	<p>Maritime Administration of the Democratic People's Republic of Korea Ryonhwa-2 Dong Central District Pyongyang DEMOCRATIC PEOPLE'S REPUBLIC OF KOREA P.O.Box 416, Pyongyang Telephone: +850 2 18111 8059 Fax: +850 3 381 4410 Email: mab@silibank.com</p>
<p><b>DENMARK</b></p>	<p>Danish Maritime Authority P.O. Box 2605 Vermundsgade 38C 2100 Copenhagen Ø DENMARK Telephone: +45 39 17 44 00 Fax: +45 39 17 44 01 Email: SFS@dma.dk  <i>Packing, testing and certification</i> Emballage og Transportinstituttet (E.T.I.) Dansk Teknologisk Institut Gregersensvej 2630 Tåstrup DENMARK  Packagings in conformity with the IMDG Code will be marked "DK Eti"</p>
<p><b>DJIBOUTI</b></p>	<p>Director of Maritime Affairs Ministère de l'équipement et des transports P.O. Box 59 Djibouti DJIBOUTI Telephone: +253 357 913 Fax: +253 351 538/253 931/355 879</p>
<p><b>ECUADOR</b></p>	<p>Dirección General de la Marine Mercante y del Litoral P.O. Box 7412 Guayaquil ECUADOR Telephone: +593 4 526 760 Fax: +593 4 324 246 Telex: 04 3325 DIGMER ED</p>
<p><b>EQUATORIAL GUINEA</b></p>	<p>The Director General (Maritime Affairs) Ministerio de Transportes, Tecnología, Correos y Telecomunicaciones Malabo REPUBLICA DE GUINEA ECUATORIAL Telephone: +240 275 406 Fax: +240 092 618</p>

Country	Contact information for the main designated national competent authority
ERITREA	<p>Director General Department of Maritime Transport Ministry of Transport and Communications ERITREA Telephone: +291 1 121 317/189 156/185 251 Fax: +291 1 184 690 / 186 541 Email: motcrez@eol.com.er</p>
ESTONIA	<p>Estonian Maritime Administration Maritime Safety Division Valge 4 EST-11413 Tallinn ESTONIA Telephone: +372 6205 700/715 Fax: +372 6205 706 Email: mot@vta.ee</p>
ETHIOPIA	<p>Maritime Affairs Authority P.O. Box 1B61 Addis Ababa ETHIOPIA Telephone: +251 11 550 36 83/38 Fax: +251 11 550 39 60 Mobile: +251 91 151 39 73 Email: maritime@ethione.et</p>
FIJI	<p>The Director of Maritime Safety Fiji Islands Maritime Safety Administration GPO Box 326 Suva FIJI Telephone: +679 331 5266 Fax: +679 330 3251 Email: fimsa@connect.com.fj</p>
FINLAND	<p>Transport Safety Agency Trafi P.O. Box 320 FI-00101 Helsinki FINLAND Telephone: +358 20 618 500 Fax: +358 20 618 5095 Email: kirjaamo@trafi.fi</p> <p><i>Packaging and certification institute</i> Safety Technology Authority (TUKES) P.O. Box 123 FI-00181 Helsinki FINLAND Telephone: +358 96 1671 Fax: +358 96 1674 66 Email: kirjaamo@tukes.fi</p>
FRANCE	<p>MTETM/DGMT/MMD Arche sud 92055 La Défense Cedex FRANCE Telephone: +33 (0)1 40 81 86 49 Fax: +33 (0)1 40 81 10 65 Email: olga.lefevre@equipement.gouv.fr</p>

## Part 7 – Provisions concerning transport operations

Country	Contact information for the main designated national competent authority
FRANCE (continued)	<p><i>Organizations authorized to carry out testing and type approval of packaging</i></p> <p>1 Bureau de vérifications techniques (BVT) ZAC de la Cerisaie 31, rue de Montjean 94266 Fresnes Cedex FRANCE</p> <p>2 Laboratoire d'études et de recherche des emballages métalliques (LEREM) 3, rue Fernand Hainaut 93400 Saint-Ouen FRANCE</p> <p>3 Laboratoire national d'essais (LNE) Laboratoire de Trappes 5, avenue Enrico Fermi 78197 Trappes Cedex FRANCE</p> <p>4 CEREM-LNE Sud 190, rue Georges Besse 30035 Nîmes Cedex 1 FRANCE</p> <p><i>Organizations authorized to carry out checks of mass-produced packagings</i></p> <p>1 Bureau de vérifications techniques (BVT)</p> <p>2 Laboratoire d'études et de recherche des emballages métalliques (LEREM)</p> <p>3 Laboratoire national d'essais (LNE)</p> <p>4 Bureau Veritas (BV)</p> <p>The BVT, the LNE and the BV are each authorized to carry out checks of mass-produced IBCs, within their respective areas of authority.</p> <p><i>Organizations authorized to carry out testing and initial and periodic inspections of metal and rigid plastics IBCs and of composite IBCs with plastic inner receptacles</i></p> <p>1 Bureau de vérifications techniques (BVT)</p> <p>2 Laboratoire national d'essais (LNE)</p> <p>3 Bureau Veritas (BV)</p> <p>4 Groupement des associations de propriétaires d'appareils à vapeur et électriques (GAPAVE)</p> <p><i>Organizations authorized for the approval of tanks</i></p> <p>1 American Bureau of Shipping (ABS)</p> <p>2 Bureau Veritas (BV)</p> <p>3 Lloyd's Register of Shipping (LR)</p> <p>4 Groupement des associations de propriétaires d'appareils à vapeur et électriques (GAPAVE)*</p>
GAMBIA	<p>The Director General Gambia Port Authority P.O. Box 617 Banjul THE GAMBIA Telephone: +220 4 227 270/4 227 260/4 227 266 Fax: +220 4 227 268</p>

\* For road tankers only.



Part 7 – Provisions concerning transport operations

Country	Contact information for the main designated national competent authority
<p>ICELAND <i>(continued)</i></p>	<p>Directorate of Shipping Hringbraut 121 P.O. Box 7200 127 Reykjavik ICELAND Telephone: +354 1 25844 Fax: +354 1 29835 Telex: 2307 ISINFO</p>
<p>INDIA</p>	<p>The Directorate General of Shipping Jahz Bhawan Walchand Hirachand Marg Bombay 400 001 INDIA Telephone: +91 22 263651 Telex: +DEGESHIP 2813-BOMBAY</p> <p><i>Packaging, testing and certification</i> Indian Institute of Packaging Bombay Madras Calcutta INDIA</p>
<p>INDONESIA</p>	<p>Director of Marine Safety Directorate-General of Sea Communication (Department Perhubungan) Jl. Medan Merdeka Barat No. 8 Jakarta Pusat INDONESIA Telephone: +62 381 3269 Fax: +62 384 0788</p>
<p>IRAN (ISLAMIC REPUBLIC OF)</p>	<p>Director General of Port Affairs Ports and Shipping Organization PSO Building, South Didar Ave. Shahid Haghani Highway, Vanak Square Tehran IRAN Telephone: +98 21 8493 2201 Fax: +98 21 8493 2227</p>
<p>IRELAND</p>	<p>The Chief Surveyor Marine Survey Office Department of Transport Leeson Lane Dublin 2 IRELAND Telephone: +353 1 604 14 20 Fax: +353 1 604 14 08 Email: mso@transport.ie</p>
<p>ISRAEL</p>	<p>Shipping and Ports Inspectorate Itzhak Rabin Government Complex Building 2 Pal-Yam 15a Haifa 31999 ISRAEL Telephone: +972 4 8632080 Fax: +972 4 8632118 Email: techni@mot.gov.il</p>



Country	Contact information for the main designated national competent authority
ITALY	<p>Italian Coast Guard Headquarters Ponte dei Mille 16100 Genoa ITALY Telephone: +39 010 25 18 154 + 102 +39 010 25 18 154 + 111 Fax: +39 010 24 78 245 Email: 001@sicnavge.it 005@sicnavge.it</p>
JAMAICA	<p>The Maritime Authority of Jamaica 4th Floor, Dyoil Building 40 Knutsford Boulevard Kingston 5 JAMAICA, W.I. Telephone: +1 876 929 2201 +1 876 754 7260/5 Telex: +1 876 7256 Email: maj@jamaicaships.com Website: www.jamaicaships.com</p> <p><i>Testing and certifying authority</i> The Bureau of Standards 6 Winchester Road P.O. Box 113 Kingston JAMAICA Telephone: +1 809 92 63140 7 Telex: 2291 STANBUR Jamaica Cable: STANBUREAU</p>
JAPAN	<p>Inspection and Measurement Division Maritime Bureau Ministry of Land, Infrastructure and Transport 2-1-3 Kasumigaseki, Chiyoda-ku Tokyo JAPAN Telephone: +81 3 5253 8639 Fax: +81 3 5253 1644 Email: MRB_KSK@mlit.go.jp</p> <p><i>Packaging, testing and certification</i> Nippon Hakuyohin Kentei Kyokai (HK) (The Ship Equipment Inspection Society of Japan) 3-32, Kioi-Cho, Chiyoda-ku Tokyo JAPAN Telephone: +81 3 3261 6611 Fax: +81 3 3261 6979</p> <p>Packagings, IBCs and large packagings in conformity with the IMDG Code will be marked "J", "J/JG" or "J/HK".</p>
KENYA	<p>Director General Kenya Maritime Authority P.O. Box 95076 (80104) Mombasa KENYA Telephone: +254 041 2318398/9 Fax: +254 041 2318397 Email: nkarigithu@yahoo.co.uk info@maritimeauthority.co.ke karigithu@kenya.com</p>

**Part 7 – Provisions concerning transport operations**

Country	Contact information for the main designated national competent authority
<b>KENYA</b> <i>(continued)</i>	Ministry of Transport & Communications P.O. Box 52692 Nairobi KENYA Telephone: +254 020 2729200 Fax: +254 020 2724553 Email: motc@insightkenya.com peterthuo_2004@yahoo.com
<b>LATVIA</b>	Maritime Administration of Latvia Maritime Safety Department Trijadibas iela, 5 LV-1048 Riga LATVIA Telephone: +371 670 62 171 +371 670 62 120 Fax: +371 678 60 083 Email: janis.sticenko@lja.lv Website: www.jurasadministracija.lv  <i>Classification Societies</i> American Bureau of Shipping Bureau Veritas Det Norske Veritas Lloyd's Register of Shipping Russian Maritime Register of Shipping
<b>LIBERIA</b>	Commissioner/Administration Bureau of Maritime Affairs P.O. Box 10-9042 1000 Monrovia 10 Monrovia LIBERIA Telephone: +231 227 744/37747/510 201 Fax: +231 226 069 Email: maritime@liberia.net  <i>Testing and certification</i> American Bureau of Shipping Bureau Veritas China Classification Society Det Norske Veritas Germanischer Lloyd Korean Register of Shipping Lloyd's Register of Shipping Nippon Kaiji Kyokai Polski Rejestr Statkow Registro Italiano Navale Russian Maritime Register of Shipping
<b>LITHUANIA</b>	<i>Implementation</i> Ministry of Transport and Communications Water Transport Department Gedimino Av. 17 01505 Vilnius LITHUANIA Telephone: +370 5 239 3986 Fax: +370 5 212 4335 Email: d.krivickiene@transp.lt

Country	Contact information for the main designated national competent authority
<p><b>LITHUANIA</b> <i>(continued)</i></p>	<p><i>Inspection</i> Lithuanian Maritime Safety Administration J. Janonio Str. 24 92251 Klaipeda LITHUANIA Telephone: +370 46 469 662 Fax: +370 46 469 600 Email: alvydas.nikolajus@msa.lt</p>
<p><b>MADAGASCAR</b></p>	<p>Director Agence Portuaire Maritime et Fluviale (APMF) P.O. Box 581 Antananarivo-101 MADAGASCAR Telephone: +261 20 242 5701 Telephone/Fax: +261 20 222 5860 Mobile: +261 320 229 259 Email: spapmf.dt@mttptat.gov.mg</p>
<p><b>MALAWI</b></p>	<p>Director of Marine Services Marine Department Ministry of Transport &amp; Civil Aviation Private Bag A81 Capital City Lilongwe MALAWI Telephone: +265 1 755 546/752 666 Direct line: 753 531 Fax: +265 1 750 157/758 894 Email: marinedepartment@malawi.net marinesafety@africa-online.net</p>
<p><b>MALAYSIA</b></p>	<p>Director Marine Department Peninsular Malaysia P.O. Box 12 42009 Port Kelang Selangor MALAYSIA Telex: MA 39748</p> <p>Director Marine Department, Sabah P.O. Box 5 87007 Labuan Sabah MALAYSIA</p> <p>Director Marine Department, Sarawak P.O. Box 530 93619 Kuching Sarawak MALAYSIA</p>
<p><b>MARSHALL ISLANDS</b></p>	<p>Office of the Maritime Administrator Maritime Operations Department Republic of the Marshall Islands 11495 Commerce Park Drive Reston, Virginia 20191-1507 USA Telephone: +1 703 620 4880 Fax: +1 703 476 8522 Telex: 248403 IRI UR Email: maritime@register-iri.com</p>

Part 7 – Provisions concerning transport operations

Country	Contact information for the main designated national competent authority
<b>MAURITIUS</b>	<p>Director of Shipping Ministry of Land Transport, Shipping and Public Safety New Government Centre, 4 Floor Port Louis MAURITIUS Telephone: +230 201 2115 Fax: +230 211 7699/216 1612/201 3417 Mobile: +230 774 0764 Email: pseebaluck@mail.gov.mu</p>
<b>MEXICO</b>	<p><i>Stowage, segregation, labelling and documentation of goods</i> Coordinación General de Puertos y Marina Mercante Secretaría de Comunicaciones y Transportes Avenida Nuevo León no. 210, Piso 19 Colonia Hipódromo Condesa, C.P. 06100 México, Distrito Federal MEXICO Telephone: +52 55 5265 3110 Fax: +52 55 5265 3108 Email: achacon@sct.gob.mx</p> <p><i>Receipt and processing of notifications in the event of a package falling overboard</i> Secretaría de Marina Eje 2 Oriente, tramo Heroica Escuela Naval Militar no. 861 Colonia Los Cipreses, C.P. 04830 México, Distrito Federal MEXICO Telephone: +52 55 5624 6500 Email: subsrio@semar.gob.mx</p> <p><i>Laboratory testing of packagings containing dangerous goods</i> Dirección General de la Sociedad Mexicana de Normalización y Certificación S.C. (NORMEX) Avenida San Antonio no. 256, Piso 7 Colonia Ampliación Nápoles, C.P. 03849 MEXICO Telephone: +52 55 5598 3036 Fax: +52 55 5598 5899 Email: normex@normex.com.mx</p>
<b>MONTENEGRO</b>	<p>Ministry of Interior and Public Administration of the Republic of Montenegro Department for Contingency Plans and Civil Security REPUBLIC OF MONTENEGRO Telephone: +382 81 241 590 Fax: +382 81 246 779 Email: mup.emergency@cg.yu</p>
<b>MOROCCO</b>	<p>Direction de la Marine Marchande et des Pêches Maritimes Boulevard El Hansali Casablanca MOROCCO Telephone: +1 212 227 8092 +1 212 222 1931 Telex: 24613 MARIMAR M 22824</p>

Country	Contact information for the main designated national competent authority
<b>MOZAMBIQUE</b>	<p>General Director National Maritime Authority (INAMAR) Av. Marquês do Pombal No. 297 P.O. Box 4317 Maputo MOZAMBIQUE</p> <p>Telephone: +258 21 320 552 Fax: +258 21 324 007 Mobile: +258 82 153 0280 Email: inamar@tvcabo.co.mz</p> <p><i>Testing and certification of packaging, intermediate bulk containers and large packaging</i></p> <p>Instituto Nacional de Normalização e Qualidade (INNOQ) Av. 25 de Setembro No. 1179, 2nd Floor Maputo MOZAMBIQUE</p> <p>Telephone: +258 21 303 822/3 Fax: +258 21 304 206 Mobile: +258 823 228 840 Email: innoq@emilmoz.com</p>
<b>NAMIBIA</b>	<p>Director of Maritime Affairs Ministry of Works, Transport and Communications Private Bag 13341 6719 Bell Street Snyman Circle, Windhoek NAMIBIA</p> <p>Telephone: +264 61 208 8025/6 Direct line: 208 8111 Fax: +264 61 240 024/224 060 Mobile: +264 811 220 599 Email: mmnangolo@mwtc.gov.na</p>
<b>NETHERLANDS</b>	<p>Ministry of Transport, Public Works and Water Management P.O. Box 20904 2500 EX The Hague NETHERLANDS</p> <p>Telephone: +31 70 351 6171 Fax: +31 70 351 1479</p> <p>Ministry of Transport, Public Works, Transport and Water Management Inspectorate P.O. Box 90653 2509 LR The Hague NETHERLANDS</p> <p>Telephone: +31 88 489 0000 Fax: +31 70 456 2413 Email: via <a href="http://www.ivw.nl/english/contact">www.ivw.nl/english/contact</a></p> <p><b>Netherlands Antilles</b> Directorate of Shipping and Maritime Affairs Seru Mahuma z/n Curaçao Netherlands Antilles (NETHERLANDS)</p> <p>Telephone: +599(9) 839 3700 +599(9) 839 3701 Fax: +599(9) 868 9964 Email: sina@onenet.an expertise@dsmz.org management@dsmz.org</p>

Part 7 – Provisions concerning transport operations

Country	Contact information for the main designated national competent authority
NEW ZEALAND	<p>Maritime New Zealand Level 10, Optimisation House 1 Grey Street PO Box 27-006 Wellington NEW ZEALAND Telephone: +64 4 473 0111 Fax: +64 4 494 1263 Email: enquiries@maritimenz.govt.nz Website: www.maritimenz.govt.nz</p> <p>The authorized organizations which have delegated authority from the Director of Maritime Safety for the approval, inspection and testing of all portable tanks, tank containers and freight containers are:</p> <p>American Bureau of Shipping Bureau Veritas Det Norske Veritas Germanischer Lloyd Lloyd's Register of Shipping</p>
NIGERIA	<p>Nigerian Maritime Administration and Safety Agency (NIMASA) Maritime House 4 Burma Road, Apapa PMB 12861, GPO Marina Lagos NIGERIA Telephone: +234 587 2214 / 580 4800/9 Fax: +234 587 1329 Telex: 23891 NAMARING Website: www.nimasa.gov.ng</p>
NORWAY	<p>Norwegian Maritime Directorate Smedasundet 50A N-5528 Haugesund NORWAY Telephone: +47 5274 5000 Fax: +47 5274 5001 Email: postmottak@sjofartsdir.no</p> <p><i>Certification of packaging and IBCs</i> Det Norske Veritas AS Veritasveien 1 N-1322 Høvik NORWAY Telephone: +47 67 57 99 00 Fax: +47 67 57 99 11 Email: TNCNO754@dnv.com</p> <p><i>Certification of CSC containers</i> Det Norske Veritas AS Veritasveien 1 N-1322 Høvik NORWAY Telephone: +47 67 57 99 00 Fax: +47 67 57 99 11 Email: mptno876@dnv.com</p> <p>Lloyd's Register EMEA P.O. Box 1562 Vika N-0253 Oslo NORWAY Telephone: +47 23 23 92 70 Fax: +47 23 23 92 71 Email: oslo@lr.org</p>

Country	Contact information for the main designated national competent authority
<p><b>NORWAY</b> <i>(continued)</i></p>	<p><i>Certification of IMO tanks</i> Det Norske Veritas AS Veritasveien 1 N-1322 Høvik NORWAY Telephone: +47 67 57 99 00 Fax: +47 67 57 99 11 Email: mptno876@dnv.com</p>
<p><b>PAKISTAN</b></p>	<p>Mercantile Marine Department 70/4 Timber Hard N.M. Reclamation Keamari, Post Box No. 4534 Karachi 75620 PAKISTAN Telephone: +92 21 2851306 +92 21 2851307 Fax: +92 21 4547472 (24 hours) +92 21 4547897 Telex: 29822 DGPS PK (24 hours)</p>
<p><b>PANAMA</b></p>	<p>Autoridad Marítima de Panamá Edificio 5534 Diablo Heights P.O. Box 0816 01548 Panamá PANAMA Telephone: +507 501 5000 Fax: +507 501 5007 Email: ampadmon@amp.gob.pa Website: www.amp.gob.pa</p>
<p><b>PAPUA NEW GUINEA</b></p>	<p>First Assistant Secretary Department of Transport Division of Marine P.O. Box 457 Konedobu PAPUA NEW GUINEA (PNG) Telephone: +675 211866 Telex: 22203</p>
<p><b>PERU</b></p>	<p>Dirección General de Capitanías y Guardacostas Marina de Guerra del Perú Jr. Constitución No. 150 Callao PERU Telephone: +51 1 613 6857 Fax: +51 1 613 6857 / 6726 Telex: 26042 PE COSTCAL Email: dicapi.medioambiente@dicapi.mil.pe</p> <p>Dirección General de Capitanías y Guardacostas Comandancia de Operaciones Guardacostas Constitución 150 Callao PERU Telephone: +51 1 4291547/4200766/4202020 Fax: +51 1 4291547 Email: pemcc@dicapi.mil.pe/comoperguard@dicapi.mil.pe</p>

## Part 7 – Provisions concerning transport operations

Country	Contact information for the main designated national competent authority
<b>PERU</b> (continued)	<p>Dirección General de Capitanías y Guardacostas            Costera Paita            Paita            PERU            Telephone: +51 1 73 211670            Fax: +51 1 73 211670            Email: costera.paita@dicapi.mil.pe            MMSI: 007600121            Radio Call Sign: OBY2            Lenguaje entendido: Español/ingles</p> <p>Dirección General de Capitanías y Guardacostas            Costera Callao            Constitución 150            Callao            PERU            Telephone: +51 1 4299798 /4200177            Fax: +51 1 4299798            Email: costera.callao@dicapi.mil.pe            MMSI: 007600125            Radio Call Sign: OB3            Lenguaje entendido: Español / ingles            Telephone: +51 1 6136868 anexo 6671 / anexo 6752            Fax: +51 1 6136856 / +51 1 4121913            Email: dicaasuntos@dicapi.mil.pe</p>
<b>PHILIPPINES</b>	<p>Philippines Ports Authority            Port of Manila            Safety Staff            P.O. Box 193            Port Area            Manila 2803            PHILIPPINES            Telephone: +63 2473441 to 49</p>
<b>POLAND</b>	<p>Ministry of Maritime Economy            Department of Maritime Safety            00-928 Warsaw            ul. Chatubińskiego 4/6            POLAND            Telephone: +48 22 630 15 40            Fax: +48 22 830 09 47</p> <p><i>Packaging, testing and certification</i>            Centralny Ośrodek Badawczo-Rozwojowy            Opakowań            ul.Konstancińska 11            02-942 Warszawa            POLAND            Telephone: +48 22 42 20 11            Fax: +48 22 42 23 03            Telex: 812473</p> <p>Packagings in conformity with the IMDG Code will be marked "PL".</p>



Country	Contact information for the main designated national competent authority
<b>POLAND</b> <i>(continued)</i>	<i>Classification societies</i> For CSC Containers Polski Rejestr Statków (Polish Register of Shipping) Al.Gen.J.Hallera 126 80-416 Gdańsk POLAND Telephone: +48 58 41 17 64 +48 58 46 03 82 +48 58 41 64 82 Fax: +48 58 46 03 92 +48 58 46 13 96 Telex: 0512 952 PRS PL
<b>PORTUGAL</b>	Direcção-Geral de Navegação e dos Transportes Marítimos Praça Luis de Camões, 22 – 2º Dto 1200 Lisboa PORTUGAL Telephone: +351 1 373821 Fax: +351 1 373826 Telex: 16753 SEMM PO
<b>REPUBLIC OF KOREA</b>	Maritime Technology Division Maritime Safety Policy Bureau Ministry of Land, Transport and Maritime Affairs (MLTM) 88, Gwanmunro, Gwacheon-si, Gyeonggi-do, 427-712 REPUBLIC OF KOREA Telephone: +82 2 2110 8590 Fax: +82 2 504 3062
<b>RUSSIAN FEDERATION*</b>	Department of State Policy for Maritime and River Transport Ministry of Transport of the Russian Federation Rozhdestvenka Street, 1, bldg. 1 Moscow 109012 RUSSIAN FEDERATION Telephone: +7 495 926 14 74  Classification society has been designated as competent inspector agency for the approval, acceptance and all consequential activities connected with IMO Type tanks, CSC containers, IBCs and packaging to be registered in the Russian Federation:  Russian Maritime Register of Shipping Telephone: +78 123 128 878 +78 123 140 743 +78 123 141 087 Telex: 121525 RSSU RU Email: pobox@rs-head.spb.ru  Ministry of Transport of the Russian Federation Regulation of Maritime Transport Operation Department 1/4 Rozhdestvenka Street Moscow 103759 RUSSIAN FEDERATION Telephone: +7 095 151 3839 +7 095 151 3406 +7 095 151 3839 Telex: 411197 MMF RU

\* Except for governmental explosives

Part 7 – Provisions concerning transport operations

Country	Contact information for the main designated national competent authority
<p><b>RUSSIAN FEDERATION*</b> <i>(continued)</i></p>	<p><i>Packaging, testing and certification</i> Central Marine Research and Design Institute (CNIMF) 6, Kavalergardskaya Street Saint Petersburg 193015 RUSSIAN FEDERATION Telephone: +7 812 275 89 47 Fax: +7 812 274 38 64 Telex: 821483 CNIMF RU</p>
<p><b>SAINT KITTS AND NEVIS</b></p>	<p>Department of Maritime Affairs Director of Maritime Affairs Ministry of Transport P.O. Box 186 Needsmust ST. KITTS, W.I. Telephone: +869 466 7032/4846 Fax: +869 465 0604/9475 Email: Maritimeaffairs@yahoo.com</p> <p>St. Kitts and Nevis International Registrar of Shipping and Seamen West Wing, York House 48-50 Western Road Romford RM1 3LP UNITED KINGDOM Telephone: +44 1708 380 400 Fax: +44 1708 380 401 Email: mail@stkittsregistry.net</p>
<p><b>SAO TOME &amp; PRINCIPE</b></p>	<p>The Minister Ministry of Public Works, Infrastructure &amp; Land Planning C.P. 171 SAO TOME &amp; PRINCIPE Telephone: +239 223 203/239 226 368 Fax: +239 222 824</p>
<p><b>SAUDI ARABIA</b></p>	<p>Port Authority Saudi Arabia Civil Defence Riyadh SAUDI ARABIA Telephone: +966 1 464 9477</p>
<p><b>SEYCHELLES</b></p>	<p>Director General Seychelles Maritime Safety Administration P.O. Box 912 Victoria, Mahe SEYCHELLES Telephone: +248 224 866 Fax: +248 224 829 Email: dg@msa.sc</p>
<p><b>SIERRA LEONE</b></p>	<p>The Executive Director Sierra Leone Maritime Administration Maritime House Government Wharf Ferry Terminal P.O. Box 313 Freetown SIERRA LEONE Telephone: +232 22 221 211 Fax: +232 22 221 215 Email: slma@sierratel.sl slmaoffice@yahoo.com</p>

\* Except for governmental explosives

Country	Contact information for the main designated national competent authority
<b>SINGAPORE</b>	<p>Maritime and Port Authority of Singapore Shipping Division 21st Storey PSA Building 460 Alexandra Road SINGAPORE 119963 Telephone: +65 375 1931/6223/1600 Fax: +65 375 6231 Email: shipping@mpa.gov.sg</p>
<b>SLOVENIA</b>	<p>Uprava Republike Slovenije za pomorstvo Ukmarjev trg 2 66 000 Koper SLOVENIA Telephone: +386 66 271 216 Fax: +386 66 271 447 Telex: +34 235 UP POM SI</p>
<b>SOUTH AFRICA</b>	<p>South African Maritime Safety Authority P.O. Box 13186 Hatfield 0028 Pretoria SOUTH AFRICA Telephone: +27 12 342 3049 Fax: +27 12 342 3160</p> <p>South African Maritime Safety Authority Hatfield Gardens, Block E (Ground Floor) Corner Arcadia and Grosvenor Street Hatfield 0083 Pretoria SOUTH AFRICA</p> <p><i>Head Office Administration</i> Chief Director Chief Directorate – Shipping Department of Transport Private Bag X193 0001 Pretoria SOUTH AFRICA Telephone: +27 12 290 2904 Fax: +27 12 323 7009</p> <p><i>Durban, East London, Port Elizabeth and Richards Bay</i> Chief Ship Surveyor Eastern Zone Department of Transport Marine Division Private Bag X54309 Durban SOUTH AFRICA Telephone: +27 12 3071501 Fax: +27 23 3064983</p> <p><i>Cape Town, Saldanha Bay and Mossel Bay</i> Chief Ship Surveyor Western Zone Department of Transport Marine Division Private Bag X7025 8012 Roggebaai SOUTH AFRICA Telephone: +2721 216 170 Fax: +2721 419 0730</p>

Part 7 – Provisions concerning transport operations

Country	Contact information for the main designated national competent authority
SPAIN	<p>Dirección General de la Marina Mercante Subdirección General de Seguridad Marítima y Contaminación c/Ruiz de Alarcón, 1 28071 Madrid SPAIN Telephone: +34 91 597 92 69/70 Fax: +34 91 597 92 87 Email: mercancias.peligrosas@fomento.es pmreal@fomento.es</p> <p>Subdirección General de Calidad y Seguridad Industrial Ministerio de Industria, Turismo y Comercio Paseo de la Castellana, 160 28071 Madrid SPAIN Telephone: +34 91 349 43 03 Fax: +34 91 349 43 00</p>
SUDAN	<p>Director Maritime Administration Directorate Ministry of Transport Port Sudan P.O. Box 531 SUDAN Telephone: +249 311 825 660 Fax: +249 311 831 276 Mobile: +249 912 51 105/310 997 Telephone/Fax: +249 1 837 742 15 Email: smaco22@yahoo.com</p>
SWEDEN	<p>Swedish Transport Agency Maritime Department Box 653 SE-601 78 Norrköping SWEDEN Telephone: +46 771 503 503 Fax: +46 11 239/934 Email: sjofart@transportstyrelsen.se</p> <p>SP, Swedish National Testing and Research Institute Building Technology and Mechanics Box 857 SE-501 15 Borås SWEDEN Telephone: +46 33 165 000 Fax: +46 33 135 502</p>
SWITZERLAND	<p>Office suisse de la navigation maritime Nauenstrasse 49 P.O. Box CH-4002 Basel SWITZERLAND Telephone: +41 61 270 91 20 Fax: +41 61 270 91 29 Email: dv-ssa@eda.admin.ch</p>

Country	Contact information for the main designated national competent authority
<b>TANZANIA</b>	<p>Director General Surface &amp; Marine Transport Regulatory Authority (SUMATRA) P.O. Box 3093 Dar es Salaam TANZANIA</p> <p>Telephone: +255 22 213 5081 Mobile: +255 744 781 865 Fax: +255 22 211 6697 Email: dg@sumatra.or.tz</p> <p>Ministry of Infrastructure Development P.O. Box 9144 Dar es Salaam TANZANIA</p> <p>Telephone: +255 22 212 2268 Fax: +255 22 211 2751/212 2079 Mobile: +254 748 7404/748 5404 Email: brufunjo@yahoo.com</p>
<b>THAILAND</b>	<p>Ministry of Transport and Communications Ratchadamnoen-Nok Avenue Bangkok 10100 THAILAND</p> <p>Telephone: +66 2 2813422 Fax: +66 2 2801714 Telex: 70000 MINOCOM TH</p>
<b>TUNISIA</b>	<p>Ministère du Transport Direction Générale de la Marine Marchande Avenue 7 novembre (près de l'aéroport) 2035 Tunis B.P. 179 Tunis cedex TUNISIA</p> <p>Telephone: +216 71 806 362 Fax: +216 71 806 413</p>
<b>TURKEY</b>	<p>Prime Ministry Undersecretariat for Maritime Affairs General Directorate for Maritime Transportation GMK BLV. No:128/A 06570 Maltepe-ANKARA TURKEY</p> <p>Telephone: +90 312 2321207 +90 312 2321249 Fax: +90 312 2313306 Email: dangerousgoods@uma.gov.tr</p>
<b>UNITED ARAB EMIRATES</b>	<p>National Transport Authority Marine Affairs Department P.O. Box 900 Abu Dhabi UNITED ARAB EMIRATES</p> <p>Telephone: +9712 4182 124 Fax: +9712 4491 500 Email: marine@nta.gov.ae</p>
<b>UNITED KINGDOM</b>	<p>Maritime and Coastguard Agency Bay 2/21 Spring Place 105 Commercial Road Southampton, SO15 1EG UNITED KINGDOM</p> <p>Telephone: +44 23 8032 9100 Fax: +44 23 8032 9204 Email: dangerous.goods@mcga.gov.uk</p>

Part 7 – Provisions concerning transport operations

Country	Contact information for the main designated national competent authority
<b>UNITED STATES</b>	<p>US Department of Transportation Pipeline and Hazardous Materials Safety Administration Office of International Standards East building / PHH-70 1200 New Jersey Ave, S.E. Washington, D.C. 20590 USA Telephone: +1 202 366 0656 Fax: +1 202 366 5713 Email: infocntr@dot.gov Website: hazmat.dot.gov</p> <p>United States Coast Guard Hazardous Materials Standards Division (CG-5223) 2100 Second Street, S.W. Washington, D.C. 20593-7126 USA Telephone: +1 202 372 1420 +1 202 372 1426 Fax: +1 202 372 1926</p>
<b>URUGUAY</b>	<p>Prefectura del Puerto de Montevideo Rambla 25 de Agosto de 1825 S/N Montevideo URUGUAY Telephone: +598 2 960123 +598 2 960022 Telex: 23929 COMAPRE-UY</p>
<b>VANUATU</b>	<p>Deputy Commissioner of Maritime Affairs c/o Vanuatu Maritime Services Limited 3/9 Broadway, Suite 2020 New York, NY 10006 USA Telephone: +212 425 9600 Fax: +212 425 9652 Email: email@vanuatuships.com Website: www.vanuatuships.com</p>
<b>VENEZUELA (BOLIVARIAN REPUBLIC OF)</b>	<p>Instituto Nacional de los Espacios Acuáticos Avenida Orinoco entre calles Perijá y Mucuchies Edificio INEA, Piso 6, Las Mercedes Caracas 1060 BOLIVARIAN REPUBLIC OF VENEZUELA Telephone: +58 212 909 1430 +58 212 909 1450 +58 212 909 1587 Fax: +58 212 909 1461 +58 212 909 1573 Email: asuntos_internacionales@inea.gob.ve Website: www.inea.gob.ve</p>
<b>VIETNAM</b>	<p>Director General Vietnam Inland Waterway Administration 80 Tran Hung Dao Hanoi VIETNAM Telephone: +84 4 9421 887 Fax: +84 4 9420 788 Email: cuctruong.viwa@mt.gov.vn</p>

Country	Contact information for the main designated national competent authority
<b>VIETNAM</b> <i>(continued)</i>	<i>Further information</i> Ms Yen International Relation Department Telephone: +84 4 9424 750 Mobile: +84 913 599 801 Email: yenton197@gmail.com viwa.inter.re@hn.vnn.vn
<b>YEMEN</b>	Executive Chairman Maritime Affairs Authority P.O. Box 19395 Sana'a REPUBLIC OF YEMEN Telephone: +967 1 414 412 / 419 914 / 423 005 Fax: +967 1 414 645 Email: MAA-Headoffice@y.net.ye Website: www.MAA.gov.ye
<b>ZAMBIA</b>	Department of Maritime & Inland Waterways Ministry of Communications & Transport P.O. Box 50346 Fairley Road Lusaka ZAMBIA Telephone: +260 1 250 716/251 444/251 022 Fax: +260 1 253 165/251 795 Email: dmiw@zamtel.zm
<b>Associate Member</b> <b>HONG KONG,</b> <b>CHINA</b>	The Director of Marine Marine Department GPO Box 4155 HONG KONG, CHINA Telephone: +852 2852 3085 Fax: +852 2815 8596 Email: pfdg@mardep.gov.hk

---

MARITIME SAFETY COMMITTEE  
90th session  
Agenda item 28

MSC 90/28/Add.3  
21 June 2012  
Original: ENGLISH

**REPORT OF THE MARITIME SAFETY COMMITTEE ON ITS  
NINETIETH SESSION**

Attached is the second part of annex 4 (Annex 2, Amendments to the International Maritime Dangerous Goods (IMDG) Code (amendment 36-12), Dangerous Goods List) to the report of the Maritime Safety Committee on its ninetieth session (MSC 90/28).

\*\*\*







IMO Dangerous Goods List

UN No. (1)	PSN (2)	Class No. (3)	Subsidiary Risk(s) (4)	Packing Group (5)	Special Provisions (6)	Limited quantities (7a)	Excepted quantities (7b)	Packing		IBC		Portable tanks and bulk containers	EIMS (15)	Stowage and Segregation (16)	Properties and Observations (17)	UN No. (18)
								Class No. (5)	Subsidiary Risk(s) (4)	Institutions (8)	Provisions (9)					
	3.1.2	2.0	2.0	2.0, 1.3	3.3	3.4	3.5	4.1, 4	4.1, 4	4.1, 4	4.1, 4	4.2, 5 4.3	5.4, 5.2 7.8	7.1 to 7.7		

0005	AMMONIUM PICKATE dry or wetted with less than 10% water, by mass	1.1 D	3497	-	-	0	ED	P112 LP101 or (6)	P26	-	-	-	F-B, S-Y	Category 04: "Away from heat" or "Away from oxidizing substances" or "Away from" lead and its compounds. Protected from sources of heat.	Substance.	0005
0005	CARTRIDGES FOR WEAPONS with bursting charge	1.1 F	-	-	-	0	ED	P130	-	-	-	-	F-B, S-X	Category 05: Protected from sources of heat.	See glossary of terms in appendix B.	0005
0006	CARTRIDGES FOR WEAPONS with bursting charge	1.1 E	-	-	-	0	ED	P130 LP101	P67 L1	-	-	-	F-B, S-X	Category 04: Protected from sources of heat.	See glossary of terms in appendix B.	0006
0007	CARTRIDGES FOR WEAPONS with bursting charge	1.2 F	-	-	-	0	ED	P130	-	-	-	-	F-B, S-X	Category 05: Protected from sources of heat.	See glossary of terms in appendix B.	0007
0009	AMMUNITION, INCENDIARY with or without burster, expelling charge or propelling charge	1.2 G	-	-	-	0	ED	P130 LP101	P67 L1	-	-	-	F-B, S-X	Category 03: Protected from sources of heat.	See glossary of terms in appendix B.	0009
0010	AMMUNITION, INCENDIARY with or without burster, expelling charge or propelling charge	1.3 G	-	-	-	0	ED	P130 LP101	P67 L1	-	-	-	F-B, S-X	Category 03: Protected from sources of heat.	See glossary of terms in appendix B.	0010
0012	CARTRIDGES FOR WEAPONS, INERT PROJECTILE or CARTRIDGES, SMALL ARMS	1.4 S	-	-	-	364	5 kg	ED	P130	-	-	-	F-B, S-X	Category 01: Protected from sources of heat.	See glossary of terms in appendix B.	0012
0014	CARTRIDGES FOR WEAPONS, BLANK or CARTRIDGES, SMALL ARMS, BLANK or CARTRIDGES FOR TOOLS, BLANK	1.4 S	-	-	-	364	5 kg	ED	P130	-	-	-	F-B, S-X	Category 01: Protected from sources of heat.	See glossary of terms in appendix B.	0014
0015	AMMUNITION, SMOKE with or without burster, expelling charge or propelling charge	1.2 G	See SP204	-	204	0	ED	P130 LP101	P67 L1	-	-	-	F-B, S-X	Category 03: Protected from sources of heat.	See glossary of terms in appendix B.	0015
0016	AMMUNITION, SMOKE with or without burster, expelling charge or propelling charge	1.3 G	See SP204	-	204	0	ED	P130 LP101	P67 L1	-	-	-	F-B, S-X	Category 03: Protected from sources of heat.	See glossary of terms in appendix B.	0016
0018	AMMUNITION, TEAR-PRODUCING with burster, expelling charge or propelling charge	1.2 G	6.1/8	-	-	0	ED	P130 LP101	P67 L1	-	-	-	F-B, S-Z	Category 03: Segregation as for Class 1.2.C; Protected from sources of heat.	See glossary of terms in appendix B.	0018
0019	AMMUNITION, TEAR-PRODUCING with burster, expelling charge or propelling charge	1.3 G	6.1/8	-	-	0	ED	P130 LP101	P67 L1	-	-	-	F-B, S-Z	Category 03: Segregation as for Class 1.2.C; Protected from sources of heat.	See glossary of terms in appendix B.	0019
0020	AMMUNITION, TOXIC with burster, expelling charge or propelling charge	1.2 K	6.1	-	274	0	ED	P101	-	-	-	-	F-B, S-Z	Category 05: Protected from sources of heat.	See glossary of terms in appendix B.	0020
0021	AMMUNITION, TOXIC with burster, expelling charge or propelling charge	1.3 K	6.1	-	274	0	ED	P101	-	-	-	-	F-B, S-Z	Category 05: Protected from sources of heat.	See glossary of terms in appendix B.	0021

UN No. (1)	PSN (2)	Class No. (3)	Subsidiary Risk(s) (4)	Packing Group (5)	Special Provisions (6)	Limited quantities (7a)	Excepted quantities (7b)	Packing		IBC		UN No. (18)	Properties and Observations (17)
								Instruc-tions (8)	Provisions (9)	Instruc-tions (10)	Provisions (11)		
	3.1.2	2.0	2.0	2.0	3.3	3.4	3.5	4.1.4	4.1.4	4.1.4	4.1.4		
0027	BLACK POWDER (GUNPOWDER) granular, or as a meal	1.1 D	-	-	-	0	EO	P113	PP50	-	-		See glossary of terms in appendix B.
0028	BLACK POWDER (GUNPOWDER), COMPRESSED or BLACK POWDER (GUNPOWDER) IN PELLETS	1.1 D	-	-	-	0	EO	P113	PP51	-	-		See glossary of terms in appendix B.
0029	DETONATORS, NON-ELECTRIC for blasting	1.1 B	-	-	-	0	EO	P131	PP68	-	-		See glossary of terms in appendix B.
0030	DETONATORS, ELECTRIC for blasting	1.1 B	-	-	-	0	EO	P131	-	-	-		See glossary of terms in appendix B.
0033	BOMBS with bursting charge	1.1 F	-	-	-	0	EO	P130	-	-	-		See glossary of terms in appendix B.
0034	BOMBS with bursting charge	1.1 D	-	-	-	0	EO	P130	PP67 LP101 LI	-	-		See glossary of terms in appendix B.
0035	BOMBS with bursting charge	1.2 D	-	-	-	0	EO	P130	PP67 LP101 LI	-	-		See glossary of terms in appendix B.
0037	BOMBS, PHOTO-FLASH	1.1 F	-	-	-	0	EO	P130	-	-	-		See glossary of terms in appendix B.
0038	BOMBS, PHOTO-FLASH	1.1 D	-	-	-	0	EO	P130	PP67 LP101 LI	-	-		See glossary of terms in appendix B.
0039	BOMBS, PHOTO-FLASH	1.2 G	-	-	-	0	EO	P130	PP67 LP101 LI	-	-		See glossary of terms in appendix B.
0042	BOOSTERS without detonator	1.1 D	-	-	-	0	EO	P132 (a) or (b)	-	-	-		See glossary of terms in appendix B.
0043	BURSTERS explosive	1.1 D	-	-	-	0	EO	P133	PP69	-	-		See glossary of terms in appendix B.
0044	PRIMERS, CAP TYPE	1.4 S	-	-	-	0	EO	P133	-	-	-		See glossary of terms in appendix B.
0048	CHARGES, DEMOLITION	1.1 D	-	-	-	0	EO	P130	PP67 LP101 LI	-	-		See glossary of terms in appendix B.
0049	CARTRIDGES, FLASH	1.1 G	-	-	-	0	EO	P135	-	-	-		See glossary of terms in appendix B.
0050	CARTRIDGES, FLASH	1.3 G	-	-	-	0	EO	P135	-	-	-		See glossary of terms in appendix B.

UN No. (1)	PSN (2)	Class No. (3)	Subsidiary Risk(s) (4)	Packing Group (5)	Special Provisions (6)	Limited quantities (7a)	Excepted quantities (7b)	Packing		IBC	
								Institutions (8)	Provisions (9)	Institutions (10)	Provisions (11)
3.1.2		2.0	2.0	2.0, 1.3	3.3	3.4	3.5	4.1, 4	4.1, 4	4.1, 4	4.1, 4

0054 CARTRIDGES, SIGNAL 1.3 C - - - 0 EO P135 - - - See glossary of terms in appendix B. 0054

0055 CASES, CARTRIDGE, EMPTY, WITH PRIMER 1.4.5 - - 364 5 kg EO P136 - - - See glossary of terms in appendix B. 0055

0056 CHARGES, DEPTH 1.1 D - - - 0 EO P130, P167, LP101, L1 - - - See glossary of terms in appendix B. 0056

0059 CHARGES, SHARED without detonator 1.1 D - - - 0 EO P137 P970 - - - See glossary of terms in appendix B. 0059

0060 CHARGES, SUPPLEMENTARY, EXPLOSIVE 1.1 D - - - 0 EO P132 (a) or (b) - - - See glossary of terms in appendix B. 0060

0065 CORD, DETONATING flexible 1.1 D - - - 0 EO P139 P971, P972 - - - See glossary of terms in appendix B. 0065

0066 CORD, IGNITER 1.4 C - - - 0 EO P140 - - - See glossary of terms in appendix B. 0066

0070 CUTTERS, CABLE, BXPLOSIVE 1.4.5 - - - 0 EO P134 LP102 - - - See glossary of terms in appendix B. 0070

0072 CYCLOTRIMETHYLENETRIMINE, (CYCLONITE), (RDX) (HFOGEM), WETTED with not less than 15% water, by mass 1.1 D - - 266 0 EO P112 (a) PM45 - - - Mass detonating explosive which becomes more sensitive if the wetting agent is lost. This substance when containing less alcohol, water or phlegmatizer than specified, shall not be transported, unless specifically authorized by the competent authority. 0072

0073 DETONATORS FOR AMMUNITION 1.1 B - - - 0 EO P133 - - - See glossary of terms in appendix B. 0073

0074 DIAZODINITROPHENOL, WETTED with not less than 40% water or mixture of alcohol and water, by mass 1.1 A - - 266 0 EO P110 (a) or (b) PM42 - - - Sensitive substance used in detonators, which becomes extremely sensitive if the wetting agents are lost. This substance, when containing less alcohol, water or phlegmatizer than specified, shall not be transported, unless specifically authorized by the competent authority. 0074

0075 DIETHYLENEGLYCOL DINITRATE, DESENSITIZED with not less than 25% non-volatile water-insoluble phlegmatizer, by mass 1.1 D - - 266 0 EO P115 PPS3, PPS4, PPS2, PPS5 - - - This substance, when containing less alcohol, water or phlegmatizer than specified, shall not be transported, unless specifically authorized by the competent authority. 0075

0076 DINITROPHENOL, dry or wetted with less than 15% water, by mass 1.1 D 6.1 P - - 0 EO P112 (a), (b) or (c) P226 - - - Substance. Category 04. "Away from" lead and its compounds. Protected from sources of heat. 0076

0077 DINITROPHENOLATES alkali metals, dry or wetted with less than 15% water, by mass 1.3 C 6.1 P - - 0 EO P114 (a) or (b) P226 - - - Substance. Category 04. "Away from" lead and its compounds. Protected from sources of heat. 0077

UN No. (18)	Properites and Observations (17)	Stowage and Segregation (16)	Portable tanks and bulk containers	
			Tank instructions (15)	Provisions (14)
		7.1 to 7.7	4.2.5, 4.3	4.2.5, 7.8

See glossary of terms in appendix B. 0054

See glossary of terms in appendix B. 0055

See glossary of terms in appendix B. 0056

See glossary of terms in appendix B. 0059

See glossary of terms in appendix B. 0060

See glossary of terms in appendix B. 0065

See glossary of terms in appendix B. 0066

See glossary of terms in appendix B. 0070

See glossary of terms in appendix B. 0072

See glossary of terms in appendix B. 0073

See glossary of terms in appendix B. 0074

See glossary of terms in appendix B. 0075

See glossary of terms in appendix B. 0076

See glossary of terms in appendix B. 0077

UN No. (1)	PSN (2)	Class No. (3)	Subsidiary Risk(s) (4)	Packing Group (5)	Special Provisions (6)	Limited quantities (7a)	Excepted quantities (7b)	Packing		IBC		Portable tanks and bulk containers		EMs (15)	Stowage and Segregation (16)	Properties and Observations (17)	UN No. (18)
								Institutions (8)	Provisions (9)	Institutions (10)	Provisions (11)	Tank instructions (12)	Provisions (13)				
0078	DINITRORESORCINOL dry or wetted with less than 15% water, by mass	1.1 D	-	-	-	0	EO	P112 (a) or (c)	P26	-	-	-	-	F-B, S-Y	Category 04: "Away from" lead and sources of heat.	Substance.	0078
0079	HEXANITRODIPIRYLAMINE (DIPICRYLAMINE), (HEXY)	1.1 D	-	-	-	0	EO	P112 (b) or (c)	-	-	-	-	-	F-B, S-Y	Category 04: Protected from sources of heat.	Substance.	0079
0081	EXPLOSIVE, BLASTING, TYPE A	1.1 D	-	-	-	0	EO	P116	PR3 PR6	-	-	-	-	F-B, S-Y	Category 04: When containing ammonium compounds, "Away from" chlorates or perchlorates and perchlorates: Protected from sources of heat.	Substance. See glossary of terms in appendix B.	0081
0082	EXPLOSIVE, BLASTING, TYPE B	1.1 D	-	-	-	0	EO	P116	PR1 PR2 PR6	BC100 B9	-	-	-	F-B, S-Y	Category 04: When containing ammonium compounds, "Away from" chlorates or perchlorates and explosives containing chlorates or sources of heat.	Substance. See glossary of terms in appendix B.	0082
0083	EXPLOSIVE, BLASTING, TYPE C	1.1 D	-	-	267	0	EO	P116	-	-	-	-	-	F-B, S-Y	Category 04: "Away from" ammonium compounds and explosives containing ammonium compounds or salts. Protected from sources of heat.	Substance. See glossary of terms in appendix B.	0083
0084	EXPLOSIVE, BLASTING, TYPE D	1.1 D	-	-	-	0	EO	P116	-	-	-	-	-	F-B, S-Y	Category 04: Protected from sources of heat.	Substance. See glossary of terms in appendix B.	0084
0092	FLARES, SURFACE	1.3 G	-	-	-	0	EO	P135	-	-	-	-	-	F-B, S-X	Category 03: Protected from sources of heat.	See glossary of terms in appendix B.	0092
0093	FLARES, AERIAL	1.3 G	-	-	-	0	EO	P135	-	-	-	-	-	F-B, S-X	Category 03: Protected from sources of heat.	See glossary of terms in appendix B.	0093
0094	FLASH POWDER	1.1 G	-	-	-	0	EO	P113	PM9	-	-	-	-	F-B, S-Y	Category 03: Protected from sources of heat.	See glossary of terms in appendix B.	0094
0099	FRACTURING DEVICES: EXPLOSIVE for oil wells, without detonator	1.1 D	-	-	-	0	EO	P134 U102	-	-	-	-	-	F-B, S-X	Category 04: Protected from sources of heat.	See glossary of terms in appendix B.	0099
0101	FUSE, NON-DETONATING	1.3 G	-	-	-	0	EO	P140	PP74 PP75	-	-	-	-	F-B, S-X	Category 03: Protected from sources of heat.	See glossary of terms in appendix B.	0101
0102	CORD (FUSE), DETONATING metal-clad	1.2 D	-	-	-	0	EO	P139	PP71	-	-	-	-	F-B, S-X	Category 04: Protected from sources of heat.	See glossary of terms in appendix B.	0102
0103	FUSE, IGNITER tubular, metal-clad	1.4 G	-	-	-	0	EO	P140	-	-	-	-	-	F-B, S-X	Category 02: Protected from sources of heat.	See glossary of terms in appendix B.	0103
0104	CORD (FUSE), DETONATING, MILD EFFECT, metal-clad	1.4 D	-	-	-	0	EO	P139	PP71	-	-	-	-	F-B, S-X	Category 02: Protected from sources of heat.	See glossary of terms in appendix B.	0104
0105	FUSE, SAFETY	1.4 S	-	-	-	0	EO	P140	PP73	-	-	-	-	F-B, S-X	Category 01: Protected from sources of heat.	See glossary of terms in appendix B.	0105

**TSFS 2015:66  
Bilaga 1**

UN No. (1)	PSN (2)	Class No. (3)	Subsidiary Risk(s) (4)	Packing Group (5)	Special Provisions (6)	Limited quantities (7a)	Excepted quantities (7b)	Packing		IBC		Portable tanks and bulk containers	EMs (15)	Stowage and Segregation (16)	UN No. (17)	
								Institutions (a) or (b)	Provisions (9)	Institutions (10)	Provisions (11)					
0106	FUZES, DETONATING	1.1 B	-	-	-	0	ED	P1.41	-	-	-	-	F-B, S-X	Category 05: Protected from sources of heat.	See glossary of terms in appendix B.	0106
0107	FUZES, DETONATING	1.2 B	-	-	-	0	ED	P1.41	-	-	-	-	F-B, S-X	Category 05: Protected from sources of heat.	See glossary of terms in appendix B.	0107
0110	GRENADES, PRACTICE hand or rifle	1.4 S	-	-	-	0	ED	P1.41	-	-	-	-	F-B, S-X	Category 01: Protected from sources of heat.	See glossary of terms in appendix B.	0110
0113	GUANYL NITROSAMINOQUANYLIDRENE HYDRAZINE, WETTED with not less than 30% water, by mass	1.1 A	-	-	266	0	ED	P110 (a) or (b)	PM2	-	-	-	F-B, S-Y	Category 05: Protected from sources of heat.	Sensitive substance used in detonators, which becomes extremely sensitive if the wetting agents are lost. This substance, when containing less alcohol, water or phlegmatizer than specified, shall not be transported, unless specifically authorized by the competent authority.	0113
0114	QUANYL NITROSAMINOQUANYL TETRAZENE, WETTED with not less than 30% water, or mixture of alcohol and water, by mass	1.1 A	-	-	266	0	ED	P110 (a) or (b)	PM2	-	-	-	F-B, S-Y	Category 05: Protected from sources of heat.	Sensitive substance used in detonators, which becomes extremely sensitive if the wetting agents are lost. This substance, when containing less alcohol, water or phlegmatizer than specified, shall not be transported, unless specifically authorized by the competent authority.	0114
0118	HEXOLITE (HEXOTOL) dry or wetted with less than 15% water, by mass	1.1 D	-	-	-	0	ED	P112 (a), (b) or (c)	-	-	-	-	F-B, S-Y	Category 04: Protected from sources of heat.	Substance. Mixtures of mass detonating explosives.	0118
0121	IGNITERS	1.1 G	-	-	-	0	ED	P1.42	-	-	-	-	F-B, S-X	Category 03: Protected from sources of heat.	See glossary of terms in appendix B.	0121
0124	JET PERFORATING GUNS, CHARGED oil well, without detonator	1.1 D	-	-	-	0	ED	P1.01	-	-	-	-	F-B, S-X	Category 04: Protected from sources of heat.	See glossary of terms in appendix B.	0124
0129	LEAD AZIDE, WETTED with not less than 20% water, or mixture of alcohol and water, by mass	1.1 A	-	-	266	0	ED	P110 (a) or (b)	PM2	-	-	-	F-B, S-Y	Category 05: Protected from sources of heat.	Sensitive substance used in detonators, which become extremely sensitive if the wetting agents are lost. This substance, when containing less alcohol, water or phlegmatizer than specified, shall not be transported, unless specifically authorized by the competent authority.	0129
0130	LEAD STYPHNATE (LEAD TRINITRORESORCINATE), WETTED with not less than 20% water, or mixture of alcohol and water, by mass	1.1 A	-	-	266	0	ED	P110 (a) or (b)	PM2	-	-	-	F-B, S-Y	Category 05: Protected from sources of heat.	Sensitive substance used in detonators, which become extremely sensitive if the wetting agents are lost. This substance, when containing less alcohol, water or phlegmatizer than specified, shall not be transported, unless specifically authorized by the competent authority.	0130
0131	LIGHTERS, FUSE	1.4 S	-	-	-	0	ED	P1.42	-	-	-	-	F-B, S-X	Category 01: Protected from sources of heat.	See glossary of terms in appendix B.	0131
0132	DEFLAGRATING METAL SALTS OF AROMATIC NITRODERIVATIVES, N.O.S.	1.3 C	-	-	-	0	ED	P11.4 (b)	PP2.6	-	-	-	F-B, S-Y	Category 04: "Away from" lead and its compounds. Protected from sources of heat.	Substance.	0132
0133	MANNITOL HEXANITRATE (NITROMANNITE), WETTED with not less than 40% water, or mixture of alcohol and water, by mass	1.1 D	-	-	266	0	ED	P11.2 (a)	-	-	-	-	F-B, S-Y	Category 04: Protected from sources of heat.	This substance, when containing less alcohol, water or phlegmatizer than specified, shall not be transported, unless specifically authorized by the competent authority.	0133
0135	MERCURY FILUMINATE, WETTED with not less than 20% water, or mixture of alcohol and water, by mass	1.1 A	-	-	266	0	ED	P110 (a) or (b)	PM2	-	-	-	F-B, S-Y	Category 05: Protected from sources of heat.	Sensitive substance used in detonators which will become extremely sensitive if the wetting agents are lost. This substance, when containing less alcohol, water or phlegmatizer than specified, shall not be transported, unless specifically authorized by the competent authority.	0135
0136	MINES with bursting charge	1.1 F	-	-	-	0	ED	P1.30	-	-	-	-	F-B, S-X	Category 05: Protected from sources of heat.	See glossary of terms in appendix B.	0136

UN No. (1)	PSN (2)	Class No. (3)	Subsidiary Risk(s) (4)	Packing Group (5)	Special Provisions (6)	Limited quantities (7a)	Excepted quantities (7b)	Packing		IBC		Portable tanks and bulk containers		Stowage and Segregation (16)	Properties and Observations (17)	UN No. (18)
								Class (8)	Institutions (9)	Institutions (10)	Provisions (11)	Tank instructions (12)	Provisions (13)			
	3.1.2	2.0	2.0	2.0, 1.3	3.3	3.4	3.5	4.1, 4	4.1, 4	4.1, 4	4.1, 4	4.3	4.2, 5	7.1 to 7.7		
0137	MINES with bursting charge	1.1 D	-	-	-	0	EO	P130 LP101	P67 L1	-	-	-	F-B, S-X	Category 04. Protected from sources of heat.	See glossary of terms in appendix B.	0137
0138	MINES with bursting charge	1.2 D	-	-	-	0	EO	P130 LP101	P67 L1	-	-	-	F-B, S-X	Category 04. Protected from sources of heat.	See glossary of terms in appendix B.	0138
0143	NITROGLYCERIN, DESENSITIZED with not less than 40% non-volatile water-insoluble phlegmatizer, by mass	1.1 D	See SP271	-	266 271 272	0	EO	P115	P53 P54 P57 P58	-	-	-	F-B, S-Z	Category 04. Protected from sources of heat.	Substance. This substance, when containing less alcohol, water or phlegmatizer than specified, shall not be transported, unless specifically authorized by the competent authority.	0143
0144	NITROGLYCERIN SOLUTION IN ALCOHOL with more than 1% but not more than 10% nitroglycerin	1.1 D	-	-	358	0	EO	P115	P45 P46 P59 P60	-	-	-	F-B, S-Y	Category 04. Protected from sources of heat.	Substance.	0144
0146	NITROSTARCH dry or wetted, with less than 20% water, by mass	1.1 D	-	-	-	0	EO	P112 (a), (b) or (c)	-	-	-	-	F-B, S-Y	Category 04. Protected from sources of heat.	Substance.	0146
0147	NITRO UREA	1.1 D	-	-	-	0	EO	P112 (b)	-	-	-	-	F-B, S-Y	Category 04. Protected from sources of heat.	Substance.	0147
0150	PENTAERYTHRITOL TETRANITRATE; PENTABERYTHRITOL TETRANITRATE; PENTABERYTHRITOL TRINITRATE; PENTABERYTHRITOL DINITRATE; PENTABERYTHRITOL MONONITRATE; DESENSITIZED with not less than 15% phlegmatizer, by mass	1.1 D	-	-	266	0	EO	P112 (a) or (b)	-	-	-	-	F-B, S-Y	Category 04. Protected from sources of heat.	Substance. Mass detonating explosive which will become more sensitive if it loses its wetting or desensitizing agent. This substance, when transported, unless specifically authorized by the competent authority, shall not be transported, unless specifically authorized by the competent authority.	0150
0151	PENTOLITE dry or wetted with less than 15% water, by mass	1.1 D	-	-	-	0	EO	P112 (a), (b) or (c)	-	-	-	-	F-B, S-Y	Category 04. Protected from sources of heat.	Substance. Mixtures of mass detonating explosive substances.	0151
0153	TRINITROANILINE (PICRAMIDE)	1.1 D	-	-	-	0	EO	P112 (b) or (c)	-	-	-	-	F-B, S-Y	Category 04. Protected from sources of heat.	Substance.	0153
0154	TRINITROPHENOL (PICRIC ACID) dry or wetted with less than 30% water, by mass	1.1 D	-	-	-	0	EO	P112 (a), (b) or (c)	P26	-	-	-	F-B, S-Y	Category 04. Protected from sources of heat. "Away from" lead and its compounds.	Substance.	0154
0155	TRINITROCHLOROBENZENE (PICRYL CHLORIDE)	1.1 D	-	-	-	0	EO	P112 (b) or (c)	-	-	-	-	F-B, S-Y	Category 04. Protected from sources of heat.	Substance.	0155
0159	POWDER CAKE (POWDER PASTE), WETTED with not less than 25% water, by mass	1.3 C	-	-	266	0	EO	P111	P43	-	-	-	F-B, S-Y	Category 04. Protected from sources of heat.	Substance consisting of nitrocellulose impregnated with not more than 10% of nitroglycerin or other liquid organic nitrates or a mixture of these. The substance, when transported, unless specifically authorized by the competent authority, shall not be transported, unless specifically authorized by the competent authority.	0159
0160	POWDER, SMOKELESS	1.1 C	-	-	-	0	EO	P114 (b)	P50 P52	-	-	-	F-B, S-Y	Category 04. Protected from sources of heat.	Substance based on nitrocellulose used as propellant. Sensitive to sparks, friction, pressure and electrostatic discharge.	0160

UN No. (1)	PSN (2)	Class No. (3)	Subsidiary Risk(s) (4)	Packing Group (5)	Special Provisions (6)	Limited quantities (7a)	Excepted quantities (7b)	Packing		IBC		Portable tanks and bulk containers		EMs (15)	Stowage and Segregation (16)	UN No. (17)	Properties and Observations (17)
								Institutions (8)	Provisions (9)	Institutions (10)	Provisions (11)	Tank instructions (12)	Provisions (13)				
	3.1.2	2.0	2.0	2.0	3.3	3.4	3.5	4.1.4	4.1.4	4.1.4	4.1.4	4.2.5	4.2.5	5.4.3.2	7.1 to 7.7		
0161	POWDER, SMOKELESS	1.3 C	-	-	-	0	EO	P1.14 (b)	PP50 PP52	-	-	-	-	F-B, S-Y	Category 04: Protected from sources of heat.		Substances based on nitrocellulose used as propellant. Sensitive to sparks, friction, pressure and electrostatic discharge.
0167	PROJECTILES with bursting charge	1.1 F	-	-	-	0	EO	P1.30	-	-	-	-	-	F-B, S-X	Category 05: Protected from sources of heat.		See glossary of terms in appendix B.
0168	PROJECTILES with bursting charge	1.1 D	-	-	-	0	EO	P1.30 LP101	PP67 LI	-	-	-	-	F-B, S-X	Category 04: Protected from sources of heat.		See glossary of terms in appendix B.
0169	PROJECTILES with bursting charge	1.2 D	-	-	-	0	EO	P1.30 LP101	PP67 LI	-	-	-	-	F-B, S-X	Category 04: Protected from sources of heat.		See glossary of terms in appendix B.
0171	AMMUNITION, ILLUMINATING with or without burster, expelling charge or propelling charge	1.2 G	-	-	-	0	EO	P1.30 LP101	PP67 LI	-	-	-	-	F-B, S-X	Category 03: Protected from sources of heat.		See glossary of terms in appendix B.
0173	RELEASE DEVICES, EXPLOSIVE	1.4 S	-	-	-	0	EO	P1.34 LP102	-	-	-	-	-	F-B, S-X	Category 01: Protected from sources of heat.		See glossary of terms in appendix B.
0174	RIVETS, EXPLOSIVE	1.4 S	-	-	-	0	EO	P1.34 LP102	-	-	-	-	-	F-B, S-X	Category 01: Protected from sources of heat.		See glossary of terms in appendix B.
0180	ROCKETS with bursting charge	1.1 F	-	-	-	0	EO	P1.30	-	-	-	-	-	F-B, S-X	Category 05: Protected from sources of heat.		See glossary of terms in appendix B.
0181	ROCKETS with bursting charge	1.1 E	-	-	-	0	EO	P1.30 LP101	PP67 LI	-	-	-	-	F-B, S-X	Category 04: Protected from sources of heat.		See glossary of terms in appendix B.
0182	ROCKETS with bursting charge	1.2 E	-	-	-	0	EO	P1.30 LP101	PP67 LI	-	-	-	-	F-B, S-X	Category 04: Protected from sources of heat.		See glossary of terms in appendix B.
0183	ROCKETS with inert head	1.3 C	-	-	-	0	EO	P1.30 LP101	PP67 LI	-	-	-	-	F-B, S-X	Category 04: Protected from sources of heat.		See glossary of terms in appendix B.
0186	ROCKET MOTORS	1.3 C	-	-	-	0	EO	P1.30 LP101	PP67 LI	-	-	-	-	F-B, S-X	Category 04: Protected from sources of heat.		See glossary of terms in appendix B.
0190	SAMPLES, EXPLOSIVE other than initiating explosive	1	-	-	1.6 2.74	0	EO	P1.01	-	-	-	-	-	F-B, S-X	Category 05: Protected from sources of heat.		See glossary of terms in appendix B. Division and compatibility group as classified by the competent authority.
0191	SIGNAL DEVICES, HAND	1.4 G	-	-	-	0	EO	P1.35	-	-	-	-	-	F-B, S-X	Category 02: Protected from sources of heat.		See glossary of terms in appendix B.
0192	SIGNALS, RAILWAY TRACK, EXPLOSIVE	1.1 G	-	-	-	0	EO	P1.35	-	-	-	-	-	F-B, S-X	Category 03: Protected from sources of heat.		See glossary of terms in appendix B.
0193	SIGNALS, RAILWAY TRACK, EXPLOSIVE	1.4 S	-	-	-	0	EO	P1.35	-	-	-	-	-	F-B, S-X	Category 01: Protected from sources of heat.		See glossary of terms in appendix B.



UN No. (1)	PSN (2)	Class No. (3)	Subsidiary Risk(s) (4)	Packing Group (5)	Special Provisions (6)	Limited quantities (7a)	Excepted quantities (7b)	Packing		IBC	
								Institutions (8)	Provisions (9)	Institutions (10)	Provisions (11)
	3.1.2	2.0	2.0	2.0, 1.3	3.3	3.4	3.5	4.1, 4	4.1, 4	4.1, 4	4.1, 4
0194	SIGNALS, DISTRESS, ship	1.1 G	-	-	-	0	EO	P135	-	-	-
0195	SIGNALS, DISTRESS, ship	1.3 G	-	-	-	0	EO	P135	-	-	-
0196	SIGNALS, SMOKE	1.1 G	-	-	-	0	EO	P135	-	-	-
0197	SIGNALS, SMOKE	1.4 G	-	-	-	0	EO	P135	-	-	-
0204	SOUNDING DEVICES, EXPLOSIVE	1.2 F	-	-	-	0	EO	P134, P102	-	-	-
0207	TETRANITROANILINE	1.1 D	-	-	-	0	EO	P112 (b) or (c)	-	-	-
0208	TRINITROPHENYL METHANITRIMINE (TETRYL)	1.1 D	-	-	-	0	EO	P112 (b) or (c)	-	-	-
0209	TRINITROTOLUENE (TNT) dry or wetted with less than 30% water, by mass	1.1 D	-	-	-	0	EO	P112 (a), (b) or (c)	PM46	-	-
0212	TRACERS FOR AMMUNITION	1.3 G	-	-	-	0	EO	P133	PM69	-	-
0213	TRINITROANISOLE	1.1 D	-	-	-	0	EO	P112 (b) or (c)	-	-	-
0214	TRINITROBENZENE dry or wetted with less than 30% water, by mass	1.1 D	-	-	-	0	EO	P112 (a), (b) or (c)	-	-	-
0215	TRINITROBENZOIC ACID dry or wetted with less than 30% water, by mass	1.1 D	-	-	-	0	EO	P112 (a), (b) or (c)	-	-	-
0216	TRINITRO-m-CRESOL	1.1 D	-	-	-	0	EO	P112 (b) or (c)	PM26	-	-
0217	TRINITRONAPHTHALENE	1.1 D	-	-	-	0	EO	P112 (b) or (c)	-	-	-

UN No. (16)	Properties and Observations (17)	Portable tanks and bulk containers		Stowage and Segregation (16)	EIMS (15)	Tank instructions (15)	Provisions (14)
		Provisions (14)	EIMS (15)				
		4.2.5 4.3	4.2.5 7.8	7.1 to 7.7	(16)	(17)	
0194	See glossary of terms in appendix B.	-	-	Category 03: Protected from sources of heat.	F-B, S-X	-	-
0195	See glossary of terms in appendix B.	-	-	Category 03: Protected from sources of heat.	F-B, S-X	-	-
0196	See glossary of terms in appendix B.	-	-	Category 03: Protected from sources of heat.	F-B, S-X	-	-
0197	See glossary of terms in appendix B.	-	-	Category 02: Protected from sources of heat.	F-B, S-X	-	-
0204	See glossary of terms in appendix B.	-	-	Category 05: Protected from sources of heat.	F-B, S-X	-	-
0207	Substance.	-	-	Category 04: Protected from sources of heat.	F-B, S-Y	-	-
0208	Substance. Mass detonating explosive.	-	-	Category 04: Protected from sources of heat.	F-B, S-Y	-	-
0209	Substance. Tritonal is a substance consisting of trinitrotoluene (TNT) mixed with aluminium.	-	-	Category 04: Protected from sources of heat.	F-B, S-Y	-	-
0212	See glossary of terms in appendix B.	-	-	Category 03: Protected from sources of heat.	F-B, S-X	-	-
0213	Substance.	-	-	Category 04: Protected from sources of heat.	F-B, S-Y	-	-
0214	Substance.	-	-	Category 04: Protected from sources of heat.	F-B, S-Y	-	-
0215	Substance.	-	-	Category 04: Protected from sources of heat.	F-B, S-Y	-	-
0216	Substance.	-	-	Category 04: "Away from" lead and its compounds. Protected from sources of heat.	F-B, S-Y	-	-
0217	Substance.	-	-	Category 04: Protected from sources of heat.	F-B, S-Y	-	-

TSFS 2015:66  
Bilaga 1

UN No. (1)	PSN (2)	Class No. (3)	Subsidiary Risk(s) (4)	Packing Group (5)	Special Provisions (6)	Limited quantities (7a)	Excepted quantities (7b)	Packing		IBC		EMs (15)	Stowage and Segregation (16)	UN No. (17)	
								Institutions (8)	Provisions (9)	Institutions (10)	Provisions (11)				
0218	TRINITROPHENOLE	1.1 D	-	-	-	0	ED	P112 (a), (b) or (c)	-	-	-	F-B, S-Y	Category 04. Protected from sources of heat.	Substance.	0218
0219	TRINITROBENZOL (STYPHNIC ACID) dry or wetted with less than 20% water, or mixture of alcohol and water, by mass	1.1 D	-	-	-	0	ED	P112 (a), (b) or (c)	PP26	-	-	F-B, S-Y	Category 04. "Away from" lead and its compounds. Protected from sources of heat.	Substance.	0219
0220	UREA NITRATE dry or wetted with less than 20% water, by mass	1.1 D	-	-	-	0	ED	P112 (a), (b) or (c)	-	-	-	F-B, S-Y	Category 04. Protected from sources of heat.	Substance.	0220
0221	WARHEADS, TORPEDO with bursting charge	1.1 D	-	-	-	0	ED	P130 LP101	PH67 LI	-	-	F-B, S-X	Category 04. Protected from sources of heat.	See glossary of terms in appendix B.	0221
0222	AMMONIUM NITRATE with more than 0.2% combustible impurities, or ammonium nitrate with more than 0.2% carbon, to the exclusion of any other added substance	1.1 D	-	-	-	0	ED	P112 (a), (b) or (c)	PH47	-	-	F-B, S-Y	Category 04. "Away from" lead and its compounds. Protected from sources of heat.	Substance.	0222
0224	BARIUM AZIDE, dry or wetted with less than 50% water, by mass	1.1 A	6.1	-	-	0	ED	P110 (a) or (b)	PM42	-	-	F-B, S-Z	Category 05. Protected from sources of heat.	See glossary of terms in appendix B.	0224
0225	BOOSTERS WITH DETONATOR	1.1 B	-	-	-	0	ED	P133	PH69	-	-	F-B, S-X	Category 05. Protected from sources of heat.	See glossary of terms in appendix B.	0225
0226	CYCLOTRIMETHYLENEDIETERYL NITRAMINE (HMX; OCTOGEN), WETTED with not less than 15% water, by mass	1.1 D	-	-	266	0	ED	P112 (a)	PH45	-	-	F-B, S-Y	Category 04. Protected from sources of heat.	Substances. Mass detaching explosives which will become more sensitive if the wetting or desensitizing agents lost. This substance, when containing less alcohol, water or phlegmatizer than specified, shall not be transported, unless specifically authorized by the competent authority.	0226
0234	SODIUM DINITRO- <i>o</i> -CRESOLATE dry or wetted with less than 15% water, by mass	1.3 C	6.1 P	-	-	0	ED	P114 (a) or (b)	PP26	-	-	F-B, S-Z	Category 04. "Away from" lead and its compounds. Protected from sources of heat.	Substance.	0234
0235	SODIUM PICRAMATE dry or wetted with less than 20% water, by mass	1.3 C	-	-	-	0	ED	P114 (a) or (b)	PP26	-	-	F-B, S-Y	Category 04. "Away from" lead and its compounds. Protected from sources of heat.	Substance.	0235
0236	ZIRCONIUM PICRAMATE dry or wetted with less than 20% water, by mass	1.3 C	-	-	-	0	ED	P114 (a) or (b)	PP26	-	-	F-B, S-Y	Category 04. "Away from" lead and its compounds. Protected from sources of heat.	Substance.	0236
0237	CHARGES, SHAPED, FLEXIBLE LINEAR	1.4 D	-	-	-	0	ED	P138	-	-	-	F-B, S-X	Category 03. Protected from sources of heat.	See glossary of terms in appendix B.	0237
0238	ROCKETS, LINE-THROWING	1.2 G	-	-	-	0	ED	P130	-	-	-	F-B, S-X	Category 03. Protected from sources of heat.	See glossary of terms in appendix B.	0238
0240	ROCKETS, LINE-THROWING	1.3 C	-	-	-	0	ED	P130	-	-	-	F-B, S-X	Category 03. Protected from sources of heat.	See glossary of terms in appendix B.	0240

UN No. (1)	PSN (2)	Portable tanks and bulk containers			Stowage and Segregation (16)	Properties and Observations (17)	UN No. (18)
		Tank instructions (15)	Provisions (14)	EMS (15)			
3.1.2		4.2.5 4.3	4.2.5	5.4.3.2 7.8	7.1 to 7.7		

UN No. (1)	PSN (2)	Class No. (3)	Packing Group (4)	Subsidiary Risk(s) (5)	Special Provisions (6)	Limited quantities (7a)	Excepted quantities (7b)	Packing		IBC	
								Institutions (8)	Provisions (9)	Institutions (10)	Provisions (11)
3.1.2		2.0	2.0	2.0	3.3	3.4	3.5	P1.16	P6.1 P6.2 P6.5	IBC100	IBC10

0241	EXPLOSIVE, BLASTING, TYPE E	1.1 D	-	-	-	0	EO	P1.16	P6.1 P6.2 P6.5	IBC100	IBC10	-	-	F-B, S-X	Category 04: When containing from "chlorates or perchlorates or explosives containing chlorates or perchlorates. Protected from sources of heat.	See glossary of terms in appendix B.	0241							
0242	CHARGES, PROPPELLING, FOR CANNON	1.3 C	-	-	-	0	EO	P1.30	-	-	-	-	-	F-B, S-X	Category 04: Protected from sources of heat.	See glossary of terms in appendix B.	0242							
0243	AMMUNITION, INCENDIARY, WHITE PHOSPHORUS with burster, expelling charge or propelling charge	1.2 H	-	-	-	0	EO	P1.30 LP101	P6.7 L1	-	-	-	-	F-B, S-X	Category 05: Protected from sources of heat.	See glossary of terms in appendix B.	0243							
0244	AMMUNITION, INCENDIARY, WHITE PHOSPHORUS with burster, expelling charge or propelling charge	1.3 H	-	-	-	0	EO	P1.30 LP101	P6.7 L1	-	-	-	-	F-B, S-X	Category 05: Protected from sources of heat.	See glossary of terms in appendix B.	0244							
0245	AMMUNITION, SMOKE, WHITE PHOSPHORUS with burster, 1.2 H expelling charge or propelling charge	1.2 H	-	-	-	0	EO	P1.30 LP101	P6.7 L1	-	-	-	-	F-B, S-X	Category 05: Protected from sources of heat.	See glossary of terms in appendix B.	0245							
0246	AMMUNITION, SMOKE, WHITE PHOSPHORUS with burster, 1.3 H expelling charge or propelling charge	1.3 H	-	-	-	0	EO	P1.30 LP101	P6.7 L1	-	-	-	-	F-B, S-X	Category 05: Protected from sources of heat.	See glossary of terms in appendix B.	0246							
0247	AMMUNITION, INCENDIARY liquid or gel, with burster, expelling charge or propelling charge	1.3 J	-	-	-	0	EO	P1.01	-	-	-	-	-	F-B, S-X	Category 05: Protected from sources of heat.	See glossary of terms in appendix B.	0247							
0248	CONTRIVANCES, WATER-ACTIVATED with burster, expelling charge or propelling charge	1.2 L	4.3	-	274	0	EO	P1.44	P7.7	-	-	-	-	F-B, S-Y	Category 05: Protected from sources of heat.	See glossary of terms in appendix B.	0248							
0249	CONTRIVANCES, WATER-ACTIVATED with burster, expelling charge or propelling charge	1.3 L	4.3	-	274	0	EO	P1.44	P7.7	-	-	-	-	F-B, S-Y	Category 05: Protected from source of heat.	See glossary of terms in appendix B.	0249							
0250	ROCKET MOTORS WITH HYPERGEOIC LIQUIDS with or without expelling charge	1.3 L	-	-	-	0	EO	P1.01	-	-	-	-	-	F-B, S-X	Category 05: Protected from sources of heat.	See glossary of terms in appendix B.	0250							
0254	AMMUNITION, ILLUMINATING with or without burster, expelling charge or propelling charge	1.3 G	-	-	-	0	EO	P1.30 LP101	P6.7 L1	-	-	-	-	F-B, S-X	Category 03: Protected from sources of heat.	See glossary of terms in appendix B.	0254							
0255	DETONATORS, ELECTRIC for blasting	1.4 B	-	-	-	0	EO	P1.31	-	-	-	-	-	F-B, S-X	Category 05: Protected from sources of heat.	See glossary of terms in appendix B.	0255							
0257	FUZES, DETONATING	1.4 B	-	-	-	0	EO	P1.41	-	-	-	-	-	F-B, S-X	Category 05: Protected from sources of heat.	See glossary of terms in appendix B.	0257							
0266	OCTOULITE (OCTUL) dry or wetted with less than 15% water, by mass	1.1 D	-	-	-	0	EO	P1.12 P1.13 P1.14 P1.15 P1.16 P1.17 P1.18 P1.19 P1.20 P1.21 P1.22 P1.23 P1.24 P1.25 P1.26 P1.27 P1.28 P1.29 P1.30 P1.31 P1.32 P1.33 P1.34 P1.35 P1.36 P1.37 P1.38 P1.39 P1.40 P1.41 P1.42 P1.43 P1.44 P1.45 P1.46 P1.47 P1.48 P1.49 P1.50 P1.51 P1.52 P1.53 P1.54 P1.55 P1.56 P1.57 P1.58 P1.59 P1.60 P1.61 P1.62 P1.63 P1.64 P1.65 P1.66 P1.67 P1.68 P1.69 P1.70 P1.71 P1.72 P1.73 P1.74 P1.75 P1.76 P1.77 P1.78 P1.79 P1.80 P1.81 P1.82 P1.83 P1.84 P1.85 P1.86 P1.87 P1.88 P1.89 P1.90 P1.91 P1.92 P1.93 P1.94 P1.95 P1.96 P1.97 P1.98 P1.99 P1.100	-	-	-	-	-	-	-	-	-	-	-	-	F-B, S-Y	Category 04: Protected from sources of heat.	Substance. Mixtures of mass detonating explosives.	0266
0267	DETONATORS, NON-ELECTRIC for blasting	1.4 B	-	-	-	0	EO	P1.31	P6.8	-	-	-	-	F-B, S-X	Category 05: Protected from sources of heat.	See glossary of terms in appendix B.	0267							
0268	BOOSTERS WITH DETONATOR	1.2 B	-	-	-	0	EO	P1.33	P6.9	-	-	-	-	F-B, S-X	Category 05: Protected from sources of heat.	See glossary of terms in appendix B.	0268							

UN No. (1)	PSN (2)	Class No. (5)	Subsidiary Risk(s) (4)	Packing Group (3)	Special Provisions (6)	Limited quantities (7a)	Excepted quantities (7b)	Packing		IBC		Portable tanks and bulk containers		Stowage and Segregation (16)	Properties and Observations (17)	UN No. (18)	
								Institu- tions (8)	Provisions (9)	Institu- tions (10)	Provisions (11)	Tank instructions (15)	Provisions (14)				EMS (15)
3.1.2		2.0	2.0	2.0, 1.3	3.3	3.4	3.5	4.1, 4	4.1, 4	4.1, 4	4.1, 4	4.3	4.2, 5	7.1 to 7.7			0271
0271	CHARGES, PROPELLING	1.1 C	-	-	-	0	EO	P1.43	P7/6	-	-	-	-	F-8, S-X	Category 04, Protected from sources of heat.	See glossary of terms in appendix B.	0271
0272	CHARGES, PROPELLING	1.3 C	-	-	-	0	EO	P1.43	P7/6	-	-	-	-	F-8, S-X	Category 04, Protected from sources of heat.	See glossary of terms in appendix B.	0272
0275	CARTRIDGES, POWER DEVICE	1.3 C	-	-	-	0	EO	P1.34 LP102	-	-	-	-	-	F-8, S-X	Category 04, Protected from sources of heat.	See glossary of terms in appendix B.	0275
0276	CARTRIDGES, POWER DEVICE	1.4 C	-	-	-	0	EO	P1.34 LP102	-	-	-	-	-	F-8, S-X	Category 03, Protected from sources of heat.	See glossary of terms in appendix B.	0276
0277	CARTRIDGES, OIL WELL	1.3 C	-	-	-	0	EO	P1.34 LP102	-	-	-	-	-	F-8, S-X	Category 04, Protected from sources of heat.	See glossary of terms in appendix B.	0277
0278	CARTRIDGES, OIL WELL	1.4 C	-	-	-	0	EO	P1.34 LP102	-	-	-	-	-	F-8, S-X	Category 02, Protected from sources of heat.	See glossary of terms in appendix B.	0278
0279	CHARGES, PROPELLING, FOR CANNON	1.1 C	-	-	-	0	EO	P1.30	-	-	-	-	-	F-8, S-X	Category 04, Protected from sources of heat.	See glossary of terms in appendix B.	0279
0280	ROCKET MOTORS	1.1 C	-	-	-	0	EO	P1.30 LP101	P6/7 LI	-	-	-	-	F-8, S-X	Category 04, Protected from sources of heat.	See glossary of terms in appendix B.	0280
0281	ROCKET MOTORS	1.2 C	-	-	-	0	EO	P1.30 LP101	P6/7 LI	-	-	-	-	F-8, S-X	Category 04, Protected from sources of heat.	See glossary of terms in appendix B.	0281
0282	NITROCELLULOSE (PICRITED) dry or wetted with less than 20% water, by mass	1.1 D	-	-	-	0	EO	P1.12 (a), (b) or (c)	-	-	-	-	-	F-8, S-Y	Category 04, Protected from sources of heat.	Substance.	0282
0283	BOOSTERS without detonator	1.2 D	-	-	-	0	EO	P1.32 (a) or (b)	-	-	-	-	-	F-8, S-X	Category 04, Protected from sources of heat.	See glossary of terms in appendix B.	0283
0284	GRENADES hand or rifle, with bursting charge	1.1 D	-	-	-	0	EO	P1.41	-	-	-	-	-	F-8, S-X	Category 04, Protected from sources of heat.	See glossary of terms in appendix B.	0284
0285	GRENADES hand or rifle, with bursting charge	1.2 D	-	-	-	0	EO	P1.41	-	-	-	-	-	F-8, S-Y	Category 04, Protected from sources of heat.	See glossary of terms in appendix B.	0285
0286	WARHEADS, ROCKET with bursting charge	1.1 D	-	-	-	0	EO	P1.30 LP101	P6/7 LI	-	-	-	-	F-8, S-X	Category 04, Protected from sources of heat.	See glossary of terms in appendix B.	0286
0287	WARHEADS, ROCKET with bursting charge	1.2 D	-	-	-	0	EO	P1.30 LP101	P6/7 LI	-	-	-	-	F-8, S-X	Category 04, Protected from sources of heat.	See glossary of terms in appendix B.	0287
0288	CHARGES, SHAPED, FLEXIBLE, UNRAR	1.1 D	-	-	-	0	EO	P1.38	-	-	-	-	-	F-8, S-X	Category 04, Protected from sources of heat.	See glossary of terms in appendix B.	0288

UN No. (1)	PSN (2)	Class No. (5)	Subsidiary Risk(s) (4)	Packing Group (3)	Special Provisions (6)	Limited quantities (7a)	Excepted quantities (7b)	Packing		IBC		UN No. (18)
								Institutions (8)	Provisions (9)	Institutions (10)	Provisions (11)	
	3.1.2	2.0	2.0	2.0, 1.3	3.3	3.4	3.5	4.1, 4	4.1, 4	4.1, 4	4.1, 4	
0289	CORD, DETONATING flexible	1.4 D	-	-	-	0	EO	P1 39	P671 P672	-	-	0289
0290	CORD/USED, DETONATING metal-cord	1.1 D	-	-	-	0	EO	P1 39	P671	-	-	0290
0291	BOMBS with bursting charge	1.2 F	-	-	-	0	EO	P1 30	-	-	-	0291
0292	GRENADES hand or rifle, with bursting charge	1.1 F	-	-	-	0	EO	P1 41	-	-	-	0292
0293	GRENADES hand or rifle, with bursting charge	1.2 F	-	-	-	0	EO	P1 41	-	-	-	0293
0294	MINES with bursting charge	1.2 F	-	-	-	0	EO	P1 30	-	-	-	0294
0295	ROCKETS with bursting charge	1.2 F	-	-	-	0	EO	P1 30	-	-	-	0295
0296	SOUNDING DEVICES, EXPLOSIVE	1.1 F	-	-	-	0	EO	P1 34 LP1 02	-	-	-	0296
0297	AMMUNITION, ILLUMINATING with or without burster, expelling charge or propelling charge	1.4 G	-	-	-	0	EO	P1 30 LP1 01 L1	P667 L1	-	-	0297
0299	BOMBS, PHOTO-FLASH	1.3 G	-	-	-	0	EO	P1 30 LP1 01 L1	P667 L1	-	-	0299
0300	AMMUNITION, INCENDIARY with or without burster, expelling charge or propelling charge	1.4 G	-	-	-	0	EO	P1 30 LP1 01 L1	P667 L1	-	-	0300
0301	AMMUNITION, TEAR-PRODUCING with burster, expelling charge or propelling charge	1.4 G	6.1, 8	-	-	0	EO	P1 30 LP1 01 L1	P667 L1	-	-	0301
0303	AMMUNITION, SMOKE with or without burster, expelling charge or propelling charge	1.4 G	See SP204	-	204	0	EO	P1 30 LP1 01 L1	P667 L1	-	-	0303
0305	FLASH POWDER	1.3 G	-	-	-	0	EO	P1 13	PM49	-	-	0305
0306	TRACERS FOR AMMUNITION	1.4 G	-	-	-	0	EO	P1 33	PM69	-	-	0306
0312	CARTRIDGES, SIGNAL	1.4 G	-	-	-	0	EO	P1 35	-	-	-	0312

UN No. (1)	PSN (2)	Class No. (3)	Subsidiary Risk(s) (4)	Packing Group (5)	Special Provisions (6)	Limited quantities (7a)	Excepted quantities (7b)	Packing		IBC		Portable tanks and bulk containers	EHS (15)	Stowage and Segregation (16)	Properties and Observations (17)	UN No. (18)
								Instit. (8)	Provisions (9)	Instit. (10)	Provisions (11)					
	3.1.2	2.0	2.0	2.0, 1.3	3.3	3.4	3.5	4.1, 4	4.1, 4	4.1, 4	4.1, 4	4.2, 5 4.3	5.4, 5.2 7.8	7.1 to 7.7		
0313	SIGNALS, SMOKE	1.2 G	-	-	-	0	EO	P1.35	-	-	-	-	F-8, S-X	Category 03: Protected from sources of heat.	See glossary of terms in appendix B.	0313
0314	IGNITERS	1.2 G	-	-	-	0	EO	P1.42	-	-	-	-	F-8, S-X	Category 03: Protected from sources of heat.	See glossary of terms in appendix B.	0314
0315	IGNITERS	1.3 C	-	-	-	0	EO	P1.42	-	-	-	-	F-8, S-X	Category 03: Protected from sources of heat.	See glossary of terms in appendix B.	0315
0316	FUZES, IGNITING	1.3 C	-	-	-	0	EO	P1.41	-	-	-	-	F-8, S-X	Category 03: Protected from sources of heat.	See glossary of terms in appendix B.	0316
0317	FUZES, IGNITING	1.4 C	-	-	-	0	EO	P1.41	-	-	-	-	F-8, S-X	Category 03: Protected from sources of heat.	See glossary of terms in appendix B.	0317
0318	GRENADES, PRACTICE hand or rifle	1.3 C	-	-	-	0	EO	P1.41	-	-	-	-	F-8, S-X	Category 03: Protected from sources of heat.	See glossary of terms in appendix B.	0318
0319	PRIMERS, TUBULAR	1.3 C	-	-	-	0	EO	P1.33	-	-	-	-	F-8, S-X	Category 03: Protected from sources of heat.	See glossary of terms in appendix B.	0319
0320	PRIMERS, TUBULAR	1.4 C	-	-	-	0	EO	P1.33	-	-	-	-	F-8, S-X	Category 02: Protected from sources of heat.	See glossary of terms in appendix B.	0320
0321	CARTRIDGES FOR WEAPONS with bursting charge	1.2 E	-	-	-	0	EO	P1.30 LP1.01	P6.7 LI	-	-	-	F-8, S-X	Category 04: Protected from sources of heat.	See glossary of terms in appendix B.	0321
0322	ROCKET MOTORS WITH HYPERGOLIC LIQUIDS with or without expelling charge	1.2 L	-	-	-	0	EO	P1.01	-	-	-	-	F-8, S-X	Category 05: Protected from sources of heat.	See glossary of terms in appendix B.	0322
0323	CARTRIDGES, POWER DEVICE	1.4 S	-	-	347	0	EO	P1.34 LP1.02	-	-	-	-	F-8, S-X	Category 01: Protected from sources of heat.	See glossary of terms in appendix B.	0323
0324	PROJECTILES with bursting charge	1.2 F	-	-	-	0	EO	P1.30	-	-	-	-	F-8, S-X	Category 05: Protected from sources of heat.	See glossary of terms in appendix B.	0324
0325	IGNITERS	1.4 G	-	-	-	0	EO	P1.42	-	-	-	-	F-8, S-X	Category 02: Protected from sources of heat.	See glossary of terms in appendix B.	0325
0326	CARTRIDGES FOR WEAPONS, BLANK	1.1 C	-	-	-	0	EO	P1.30	-	-	-	-	F-8, S-X	Category 04: Protected from sources of heat.	See glossary of terms in appendix B.	0326
0327	CARTRIDGES FOR WEAPONS, BLANK or CARTRIDGES, SMALL ARMS, BLANK	1.3 C	-	-	-	0	EO	P1.30	-	-	-	-	F-8, S-X	Category 04: Protected from sources of heat.	See glossary of terms in appendix B.	0327
0328	CARTRIDGES FOR WEAPONS, INERT PROJECTILE	1.2 C	-	-	-	0	EO	P1.30 LP1.01	P6.7 LI	-	-	-	F-8, S-X	Category 04: Protected from sources of heat.	See glossary of terms in appendix B.	0328
0329	TORPEDOOS with bursting charge	1.1 E	-	-	-	0	EO	P1.30 LP1.01	P6.7 LI	-	-	-	F-8, S-X	Category 04: Protected from sources of heat.	See glossary of terms in appendix B.	0329

UN No. (1)	PSN (2)	Class No. (3)	Subsidiary Risk(s) (4)	Packing Group (5)	Special Provisions (6)	Limited quantities (7a)	Excepted quantities (7b)	Packing			IBC			UN No. (18)
								Institutions (8)	Provisions (9)	Institutions (10)	Provisions (11)	Institutions (12)	Provisions (13)	
	3.1.2	2.0	2.0	2.0	3.3	3.4	3.5	4.1.4	4.1.4	4.1.4	4.1.4	4.1.4		
0330	TORPEDOES with bursting charge	1.1 F	-	-	-	0	EO	P130	-	-	-	-	-	0330
0331	EXPLOSIVE, BLASTING, TYPE B (AGENT, BLASTING, TYPE B)	1.5 D	-	-	-	0	EO	P116	PG1 PG2 PG4 PG5	IBC100	-	-	-	0331
0332	EXPLOSIVE, BLASTING, TYPE E (AGENT, BLASTING, TYPE E)	1.5 D	-	-	-	0	EO	P116	PG1 PG2 PG5	IBC100	-	-	-	0332
0333	FIREWORKS	1.1 G	-	-	-	0	EO	P135	-	-	-	-	-	0333
0334	FIREWORKS	1.2 G	-	-	-	0	EO	P135	-	-	-	-	-	0334
0335	FIREWORKS	1.3 G	-	-	-	0	EO	P135	-	-	-	-	-	0335
0336	FIREWORKS	1.4 G	-	-	-	0	EO	P135	-	-	-	-	-	0336
0337	FIREWORKS	1.4 S	-	-	-	0	EO	P135	-	-	-	-	-	0337
0338	CARTRIDGES FOR WEAPONS, BLANK or CARTRIDGES, SMALL ARMS, BLANK	1.4 C	-	-	-	0	EO	P130	-	-	-	-	-	0338
0339	CARTRIDGE FOR WEAPONS, INERT PROJECTILE or CARTRIDGES, SMALL ARMS	1.4 C	-	-	-	0	EO	P130	-	-	-	-	-	0339
0340	NITROCELLULOSE dry or wetted with less than 25% water (alcohol), by mass	1.1 D	-	-	-	0	EO	P112 (a) or (b)	-	-	-	-	-	0340
0341	NITROCELLULOSE unmodified or plasticized with less than 18% plasticizing substance, by mass	1.1 D	-	-	-	0	EO	P112 (b)	-	-	-	-	-	0341
0342	NITROCELLULOSE, WETTED with not less than 25% alcohol, by mass	1.3 C	-	-	105	0	EO	P114 (a)	PM3	-	-	-	-	0342
0343	NITROCELLULOSE, PLASTICIZED with not less than 18% plasticizing substance, by mass	1.3 C	-	-	105	0	EO	P111	-	-	-	-	-	0343
0344	PROJECTILES with bursting charge	1.4 D	-	-	-	0	EO	P130 LP101 LI	PG7 LI	-	-	-	-	0344

UN No. (1)	PSN (2)	Class No. (3)	Subsidiary Risk(s) (4)	Packing Group (5)	Special Provisions (6)	Limited quantities (7a)	Excepted quantities (7b)	Packing		IBC		Tank instructions (15)	Provisions (14)	EIMS (15)	Stowage and Segregation (16)	Properties and Observations (17)	UN No. (18)
								Instruc-tions (8)	Provisions (9)	Instruc-tions (10)	Provisions (11)						
	3.1.2	2.0	2.0	2.0, 1.3	3.3	3.4	3.5	4.1, 4	4.1, 4	4.1, 4	4.1, 4	4.2, 5 4.3	4.2, 5	5.4, 5.2 7.8	7.1 to 7.7		
0345	PROJECTILES inert, with tracer	1.4 S	-	-	-	0	EO	P1 30 LP1 01	P6 7 L1	-	-	-	-	F-B, S-X	Category 01: Protected from sources of heat.	See glossary of terms in appendix B.	0345
0346	PROJECTILES with burster or expelling charge	1.2 D	-	-	-	0	EO	P1 30 LP1 01	P6 7 L1	-	-	-	-	F-B, S-X	Category 04: Protected from sources of heat.	See glossary of terms in appendix B.	0346
0347	PROJECTILES with burster or expelling charge	1.4 D	-	-	-	0	EO	P1 30 LP1 01	P6 7 L1	-	-	-	-	F-B, S-X	Category 02: Protected from sources of heat.	See glossary of terms in appendix B.	0347
0348	CARTRIDGES FOR WEAPONS with bursting charge	1.4 F	-	-	-	0	EO	P1 30	-	-	-	-	-	F-B, S-X	Category 05: Protected from sources of heat.	See glossary of terms in appendix B.	0348
0349	ARTICLES, EXPLOSIVE, N.O.S.	1.4 S	-	-	-	178 274	EO	P1 01	-	-	-	-	-	F-B, S-X	Category 01: Protected from sources of heat.	-	0349
0350	ARTICLES, EXPLOSIVE, N.O.S.	1.4 B	-	-	-	178 274	EO	P1 01	-	-	-	-	-	F-B, S-X	Category 05: Protected from sources of heat.	-	0350
0351	ARTICLES, EXPLOSIVE, N.O.S.	1.4 C	-	-	-	178 274	EO	P1 01	-	-	-	-	-	F-B, S-X	Category 02: Protected from sources of heat.	-	0351
0352	ARTICLES, EXPLOSIVE, N.O.S.	1.4 D	-	-	-	178 274	EO	P1 01	-	-	-	-	-	F-B, S-X	Category 02: Protected from sources of heat.	-	0352
0353	ARTICLES, EXPLOSIVE, N.O.S.	1.4 C	-	-	-	178 274	EO	P1 01	-	-	-	-	-	F-B, S-X	Category 02: Protected from sources of heat.	-	0353
0354	ARTICLES, EXPLOSIVE, N.O.S.	1.1 L	See SP943	-	-	178 274	EO	P1 01	-	-	-	-	-	F-B, S-X	Category 05: Protected from sources of heat.	-	0354
0355	ARTICLES, EXPLOSIVE, N.O.S.	1.2 L	See SP943	-	-	178 274	EO	P1 01	-	-	-	-	-	F-B, S-X	Category 05: Protected from sources of heat.	-	0355
0356	ARTICLES, EXPLOSIVE, N.O.S.	1.3 L	See SP943	-	-	178 274	EO	P1 01	-	-	-	-	-	F-B, S-X	Category 05: Protected from sources of heat.	-	0356
0357	SUBSTANCES, EXPLOSIVE, N.O.S.	1.1 L	-	-	-	178 274	EO	P1 01	-	-	-	-	-	F-B, S-Y	Category 05: Protected from sources of heat.	-	0357
0358	SUBSTANCES, EXPLOSIVE, N.O.S.	1.2 L	-	-	-	178 274	EO	P1 01	-	-	-	-	-	F-B, S-Y	Category 05: Protected from sources of heat.	-	0358
0359	SUBSTANCES, EXPLOSIVE, N.O.S.	1.3 L	-	-	-	178 274	EO	P1 01	-	-	-	-	-	F-B, S-Y	Category 05: Protected from sources of heat.	-	0359
0360	DETONATOR ASSEMBLIES, NON-ELECTRIC for blasting	1.1 B	-	-	-	0	EO	P1 31	-	-	-	-	-	F-B, S-X	Category 05: Protected from sources of heat.	See glossary of terms in appendix B.	0360
0361	DETONATOR ASSEMBLIES, NON-ELECTRIC for blasting	1.4 B	-	-	-	0	EO	P1 31	-	-	-	-	-	F-B, S-X	Category 05: Protected from sources of heat.	See glossary of terms in appendix B.	0361



UN No. (1)	PSN (2)	Class No. (3)	Subsidiary Risk(s) (4)	Packing Group (5)	Special Provisions (6)	Limited quantities (7a)	Excepted quantities (7b)	Packing		IBC		Portable tanks and bulk containers		EMs (15)	Stowage and Segregation (16)	Properties and Observations (17)	UN No. (18)	
								Instruc-tions (8)	Provisions (9)	Instruc-tions (10)	Provisions (11)	Tank instructions (12)	Provisions (14)					
	3.1.2	2.0	2.0	2.0, 1.3	3.3	3.4	3.5	4.1, 4	4.1, 4	4.1, 4	4.1, 4	4.2, 5 4.3	4.2, 5 7.8	7.1 to 7.7				
0362	AMMUNITION, PRACTICE	1.4 C	-	-	0	EO	P1.30 LP101	PK67 L1	-	-	-	-	F-B, S-X	Category 02. Protected from sources of heat.	See glossary of terms in appendix B.		0362	
0363	AMMUNITION, PROOF	1.4 C	-	-	0	EO	P1.30 LP101	PK67 L1	-	-	-	-	F-B, S-X	Category 02. Protected from sources of heat.	See glossary of terms in appendix B.		0363	
0364	DETONATORS FOR AMMUNITION	1.2 B	-	-	0	EO	P1.33	-	-	-	-	-	F-B, S-X	Category 05. Protected from sources of heat.	See glossary of terms in appendix B.		0364	
0365	DETONATORS FOR AMMUNITION	1.4 B	-	-	0	EO	P1.33	-	-	-	-	-	F-B, S-X	Category 05. Protected from sources of heat.	See glossary of terms in appendix B.		0365	
0366	DETONATORS FOR AMMUNITION	1.4 S	-	-	347	0	EO	P1.33	-	-	-	-	F-B, S-X	Category 01. Protected from sources of heat.	See glossary of terms in appendix B.		0366	
0367	FUZES-DETONATING	1.4 S	-	-	0	EO	P1.41	-	-	-	-	-	F-B, S-X	Category 01. Protected from sources of heat.	See glossary of terms in appendix B.		0367	
0368	FUZES, IGNITING	1.4 S	-	-	0	EO	P1.41	-	-	-	-	-	F-B, S-X	Category 01. Protected from sources of heat.	See glossary of terms in appendix B.		0368	
0369	WARHEADS, ROCKET with bursting charge	1.1 F	-	-	0	EO	P1.30	-	-	-	-	-	F-B, S-X	Category 05. Protected from sources of heat.	See glossary of terms in appendix B.		0369	
0370	WARHEADS, ROCKET with burster or expelling charge	1.4 D	-	-	0	EO	P1.30 LP101	PK67 L1	-	-	-	-	F-B, S-X	Category 02. Protected from sources of heat.	See glossary of terms in appendix B.		0370	
0371	WARHEADS, ROCKET with burster or expelling charge	1.4 F	-	-	0	EO	P1.30	-	-	-	-	-	F-B, S-X	Category 05. Protected from sources of heat.	See glossary of terms in appendix B.		0371	
0372	GRENADES, PRACTICE hand or rifle	1.2 C	-	-	0	EO	P1.41	-	-	-	-	-	F-B, S-X	Category 03. Protected from sources of heat.	See glossary of terms in appendix B.		0372	
0373	SIGNAL DEVICES, HAND	1.4 S	-	-	0	EO	P1.35	-	-	-	-	-	F-B, S-X	Category 01. Protected from sources of heat.	See glossary of terms in appendix B.		0373	
0374	SOUNDING DEVICES, EXPLOSIVE	1.1 D	-	-	0	EO	P1.34 LP102	-	-	-	-	-	F-B, S-X	Category 04. Protected from sources of heat.	See glossary of terms in appendix B.		0374	
0375	SOUNDING DEVICES, EXPLOSIVE	1.2 D	-	-	0	EO	P1.34 LP102	-	-	-	-	-	F-B, S-X	Category 04. Protected from sources of heat.	See glossary of terms in appendix B.		0375	
0376	PRIMERS, TUBULAR	1.4 S	-	-	0	EO	P1.33	-	-	-	-	-	F-B, S-X	Category 01. Protected from sources of heat.	See glossary of terms in appendix B.		0376	
0377	PRIMERS, CAP TYPE	1.1 B	-	-	0	EO	P1.33	-	-	-	-	-	F-B, S-X	Category 05. Protected from sources of heat.	See glossary of terms in appendix B.		0377	
0378	PRIMERS, CAP TYPE	1.4 B	-	-	0	EO	P1.33	-	-	-	-	-	F-B, S-X	Category 05. Protected from sources of heat.	See glossary of terms in appendix B.		0378	

**TSFS 2015:66**  
**Bilaga 1**

UN No. (1)	PSN (2)	Class No. (3)	Subsidiary Risk(s) (4)	Packing Group (5)	Special Provisions (6)	Limited quantities (7a)	Excepted quantities (7b)	Packing		IBC		Tank instructions (15)	Provisions (14)	Ems (15)	Stowage and Segregation (16)	Properties and Observations (17)	UN No. (18)
								Institutions (8)	Provisions (9)	Institutions (10)	Provisions (11)						
	3.1.2	2.0	2.0	2.0	3.3	3.4	3.5	4.1.4	4.1.4	4.1.4	4.1.4	4.2.5 4.3	4.2.5	5.4.5.2 7.8	7.1 to 7.7		
0379	CASES, CARTRIDGE, EMPTY, WITH PRIMER	1.4 C	-	-	-	0	EO	P1.36	-	-	-	-	-	F-B, S-X	Category 02. Protected from sources of heat.	See glossary of terms in appendix B.	0379
0380	ARTICLES, PYROPHORIC	1.2 L	-	-	-	0	EO	P1.01	-	-	-	-	-	F-B, S-X	Category 05. Protected from sources of heat.	See glossary of terms in appendix B.	0380
0381	CARTRIDGES, POWER DEVICE	1.2 C	-	-	-	0	EO	P1.34 LP1.02	-	-	-	-	-	F-B, S-X	Category 04. Protected from sources of heat.	See glossary of terms in appendix B.	0381
0382	COMPONENTS, EXPLOSIVE TRAIN, N.O.S.	1.2 B	-	-	178 274	0	EO	P1.01	-	-	-	-	-	F-B, S-X	Category 05. Protected from sources of heat.	See glossary of terms in appendix B.	0382
0383	COMPONENTS, EXPLOSIVE TRAIN, N.O.S.	1.4 B	-	-	178 274	0	EO	P1.01	-	-	-	-	-	F-B, S-X	Category 05. Protected from sources of heat.	See glossary of terms in appendix B.	0383
0384	COMPONENTS, EXPLOSIVE TRAIN, N.O.S.	1.4 S	-	-	178 274	0	EO	P1.01	-	-	-	-	-	F-B, S-X	Category 01. Protected from sources of heat.	See glossary of terms in appendix B.	0384
0385	5-NITROBENZOTRIAZOL	1.1 D	-	-	-	0	EO	P1.1.2 (b) or (c)	-	-	-	-	-	F-B, S-Y	Category 04. Protected from sources of heat.	Substance.	0385
0386	TRINITROBENZOSULPHONIC ACID	1.1 D	-	-	-	0	EO	P1.1.2 (b) or (c)	P2.6	-	-	-	-	F-B, S-Y	Category 04. "Away from" lead and its compounds. Protected from sources of heat.	Substance.	0386
0387	TRINITROFLUORENONE	1.1 D	-	-	-	0	EO	P1.1.2 (b) or (c)	-	-	-	-	-	F-B, S-Y	Category 04. Protected from sources of heat.	Substance.	0387
0388	TRINITROTOLUENE (TNT) AND TRINITROBENZENE MIXTURE OR TRINITROTOLUENE (TNT) AND HEXANITROSTILBENE MIXTURE	1.1 D	-	-	-	0	EO	P1.1.2 (b) or (c)	-	-	-	-	-	F-B, S-Y	Category 04. Protected from sources of heat.	Substance.	0388
0389	TRINITROTOLUENE (TNT) MIXTURE CONTAINING TRINITROBENZENE AND HEXANITROSTILBENE	1.1 D	-	-	-	0	EO	P1.1.2 (b) or (c)	-	-	-	-	-	F-B, S-Y	Category 04. Protected from sources of heat.	Substance.	0389
0390	TRITONAL	1.1 D	-	-	-	0	EO	P1.1.2 (b) or (c)	-	-	-	-	-	F-B, S-Y	Category 04. Protected from sources of heat.	Tritonal is a substance consisting of trinitrotoluene (TNT) mixed with aluminium.	0390
0391	CYCLOTRIMETHYLENETRINITRAMINE (CYCLONITE); HEXOGEN, RDX AND CYCLOTRIMETHYLENETRINITRAMINE (HMX); CYCLOTRIMETHYLENETRINITRAMINE, WETTED WITH NOT LESS THAN 15% WATER, BY MASS or CYCLOTRIMETHYLENETRINITRAMINE (CYCLONITE); HEXOGEN, RDX AND CYCLOTRIMETHYLENETRINITRAMINE (HMX), OCTOGEN MIXTURE, DESENSITIZED WITH NOT LESS THAN 1.0% PLEGMATIZER, BY MASS	1.1 D	-	-	266	0	EO	P1.1.2 (a) or (b)	-	-	-	-	-	F-B, S-Y	Category 04. Protected from sources of heat.	Substance. Mass detonating explosive which will become more sensitive if the wetting or desensitizing agents are lost. This substance, when containing less alcohol, water or plegmatizer than specified, shall not be transported, unless specifically authorized by the competent authority.	0391

UN No. (1)	PSN (2)	Class No./Div (5)	Subsidiary Risk(s) (4)	Packing Group (3)	Special Provisions (6)	Limited quantities (7a)	Excepted quantities (7b)	Packing			IBC			EMs (15)	Stowage and Segregation (16)	Properties and Observations (17)	UN No. (18)
								Institu-tions (8)	Provisions (9)	Institu-tions (10)	Provisions (11)	P112 (b) or (c)	P112 (a)				
0392	HEXANITROSTILBENE	1.1 D	-	-	-	0	EO	P112 (b) or (c)	-	-	-	-	-	F-B, S-Y	Category 04. Protected from sources of heat.	Substance. Mass detonating explosive.	0392
0393	HEXOTONAL	1.1 D	-	-	-	0	EO	P112 (b)	-	-	-	-	-	F-B, S-Y	Category 04. Protected from sources of heat.	Substance. Mass detonating explosive.	0393
0394	TRINITRORESORCINOL (STYPHNIC ACID), WETTED with not less than 20% water, or mixture of alcohol and water, by mass	1.1 D	-	-	-	0	EO	P112 (a)	PP26	-	-	-	-	F-B, S-Y	Category 04. "Away from" lead and its compounds. Protected from sources of heat.	Substance. Mass detonating.	0394
0395	ROCKET MOTORS, LIQUID FUELLED	1.2 J	-	-	-	0	EO	P101	-	-	-	-	-	F-B, S-X	Category 05. "Separated from" longitudinally by an intervening complete compartment or hold from" divisions 1.1, 1.2, 1.3, 1.5 and 1.6 except from explosives of compatibility group J. Protected from sources of heat.	See glossary of terms in appendix B.	0395
0396	ROCKET MOTORS, LIQUID FUELLED	1.3 J	-	-	-	0	EO	P101	-	-	-	-	-	F-B, S-X	Category 05. "Separated from" division 1.4 and "Separated from" longitudinally by an intervening complete compartment or hold from" divisions 1.1, 1.2, 1.3, 1.5 and 1.6 except from explosives of compatibility group J. Protected from sources of heat.	See glossary of terms in appendix B.	0396
0397	ROCKETS, LIQUID FUELLED with bursting charge	1.1 J	-	-	-	0	EO	P101	-	-	-	-	-	F-B, S-X	Category 05. "Separated from" longitudinally by an intervening complete compartment or hold from" divisions 1.1, 1.2, 1.3, 1.5 and 1.6 except from explosives of compatibility group J. Protected from sources of heat.	See glossary of terms in appendix B.	0397
0398	ROCKETS, LIQUID FUELLED with bursting charge	1.2 J	-	-	-	0	EO	P101	-	-	-	-	-	F-B, S-X	Category 05. "Separated from" division 1.4 and "Separated from" longitudinally by an intervening complete compartment or hold from" divisions 1.1, 1.2, 1.3, 1.5 and 1.6 except from explosives of compatibility group J. Protected from sources of heat.	See glossary of terms in appendix B.	0398
0399	BOMBS WITH FLAMMABLE LIQUID with bursting charge	1.1 J	-	-	-	0	EO	P101	-	-	-	-	-	F-B, S-X	Category 05. "Separated from" division 1.4 and "Separated from" longitudinally by an intervening complete compartment or hold from" divisions 1.1, 1.2, 1.3, 1.5 and 1.6 except from explosives of compatibility group J. Protected from sources of heat.	See glossary of terms in appendix B.	0399
0400	BOMBS WITH FLAMMABLE LIQUID with bursting charge	1.2 J	-	-	-	0	EO	P101	-	-	-	-	-	F-B, S-X	Category 05. "Separated from" division 1.4 and "Separated from" longitudinally by an intervening complete compartment or hold from" divisions 1.1, 1.2, 1.3, 1.5 and 1.6 except from explosives of compatibility group J. Protected from sources of heat.	See glossary of terms in appendix B.	0400
0401	DIPICRYL SULPHIDE dry or wetted with less than 10% water, by mass	1.1 D	-	-	-	0	EO	P112 (a), (b) or (c)	-	-	-	-	-	F-B, S-Y	Category 04. Protected from sources of heat.	Substance.	0401

**TSFS 2015:66**  
**Bilaga 1**

UN No. (1)	PSN (2)	Class No. (3)	Subsidiary Risk(s) (4)	Packing Group (5)	Special Provisions (6)	Limited quantities (7a)	Excepted quantities (7b)	Packing		IBC		EMs (15)	Stowage and Segregation (16)	Properties and Observations (17)	UN No. (18)
								Institu- tions (8)	Provisions (9)	Institu- tions (10)	Provisions (11)				
	3.1.2	2.0	2.0	2.0	3.3	3.4	3.5	4.1.4	4.1.4	4.1.4	4.1.4	4.2.5 4.3	7.1 to 7.7		
0402	AMMONIUM PERCHLORATE	1.1 D	-	-	152	0	EO	P112 (b) or (c)	-	-	-	F-B, S-Y	Category 04. "Away from heat" sources of heat; per chlorates or perchlorates. Protected from sources of heat.	Substance.	0402
0403	FLARES, AERIAL	1.4 G	-	-	-	0	EO	P135	-	-	-	F-B, S-X	Category 02. Protected from sources of heat.	See glossary of terms in appendix B.	0403
0404	FLARES, AERIAL	1.4 S	-	-	-	0	EO	P135	-	-	-	F-B, S-X	Category 01. Protected from sources of heat.	See glossary of terms in appendix B.	0404
0405	CARTRIDGES, SIGNAL	1.4 S	-	-	-	0	EO	P135	-	-	-	F-B, S-X	Category 01. Protected from sources of heat.	See glossary of terms in appendix B.	0405
0406	DINITROBENZENE	1.3 C	-	-	-	0	EO	P114 (b)	-	-	-	F-B, S-Y	Category 04. Protected from sources of heat.	Substance.	0406
0407	TETRAZOL-1-ACETIC ACID	1.4 C	-	-	-	0	EO	P114 (b)	-	-	-	F-B, S-Y	Category 02. Protected from sources of heat.	Substance.	0407
0408	FUZES, DETONATING with protective features	1.1 D	-	-	-	0	EO	P141	-	-	-	F-B, S-X	Category 04. Protected from sources of heat.	See glossary of terms in appendix B.	0408
0409	FUZES, DETONATING with protective features	1.2 D	-	-	-	0	EO	P141	-	-	-	F-B, S-X	Category 04. Protected from sources of heat.	See glossary of terms in appendix B.	0409
0410	FUZES, DETONATING with protective features	1.4 D	-	-	-	0	EO	P141	-	-	-	F-B, S-X	Category 02. Protected from sources of heat.	See glossary of terms in appendix B.	0410
0411	PENTAERYTHRITRE TETRAMINATE (PENTAERYTHRITOL TETRAMINATE; PETN) with not less than 7% wax, by mass	1.1 D	-	-	131	0	EO	P112 (b) or (c)	-	-	-	F-B, S-Y	Category 04. Protected from sources of heat.	Substance.	0411
0412	CARTRIDGES FOR WEAPONS with bursting charge	1.4 E	-	-	-	0	EO	P130 LP101	P67 E1	-	-	F-B, S-X	Category 03. Protected from sources of heat.	[See glossary of terms in appendix B.]	0412
0413	CARTRIDGES FOR WEAPONS, BLANK	1.2 C	-	-	-	0	EO	P130	-	-	-	F-B, S-X	Category 04. Protected from sources of heat.	See glossary of terms in appendix B.	0413
0414	CHARGES, PROPELLING, FOR CANNON	1.2 C	-	-	-	0	EO	P130	-	-	-	F-B, S-X	Category 04. Protected from sources of heat.	See glossary of terms in appendix B.	0414
0415	CHARGES, PROPELLING	1.2 C	-	-	-	0	EO	P143	P976	-	-	F-B, S-X	Category 04. Protected from sources of heat.	See glossary of terms in appendix B.	0415
0417	CARTRIDGES FOR WEAPONS, INERT PROJECTILE or CARTRIDGES, SMALL ARMS	1.3 C	-	-	-	0	EO	P130	-	-	-	F-B, S-X	Category 04. Protected from sources of heat.	See glossary of terms in appendix B.	0417
0418	FLARES, SURFACE	1.1 G	-	-	-	0	EO	P135	-	-	-	F-B, S-X	Category 03. Protected from sources of heat.	See glossary of terms in appendix B.	0418

UN No. (1)	PSN (2)	Class No. (3)	Subsidiary Risk(s) (4)	Packing Group (5)	Special Provisions (6)	Limited quantities (7a)	Excepted quantities (7b)	Packing		IBC		EHS (15)	Provisors (14)	Portable tanks and bulk containers		UN No. (16)	Properties and Observations (17)	UN No. (18)
								Instruc-tions (8)	Provisions (9)	Instruc-tions (10)	Provisions (11)			Tank instructions (12)	Provisors (13)			
	3.1.2	2.0	2.0	2.0, 1.3	3.3	3.4	3.5	4.1, 4	4.1, 4	4.1, 4	4.1, 4	4.2, 5 4.3	4.2, 5	7.1 to 7.7				
0419	FLARES, SURFACE	1.2 G	-	-	-	0	EO	P135	-	-	-	-	-	F-8, S-X	Category 03: Protected from sources of heat.	See glossary of terms in appendix B.	0419	
0420	FLARES, AERIAL	1.1 G	-	-	-	0	EO	P135	-	-	-	-	-	F-8, S-X	Category 03: Protected from sources of heat.	See glossary of terms in appendix B.	0420	
0421	FLARES, AERIAL	1.2 G	-	-	-	0	EO	P135	-	-	-	-	-	F-8, S-X	Category 03: Protected from sources of heat.	See glossary of terms in appendix B.	0421	
0424	PROJECTILES inert, with tracer	1.3 G	-	-	-	0	EO	P130 LP101	P67 L1	-	-	-	-	F-8, S-X	Category 03: Protected from sources of heat.	See glossary of terms in appendix B.	0424	
0425	PROJECTILES inert, with tracer	1.4 G	-	-	-	0	EO	P130 LP101	P67 L1	-	-	-	-	F-8, S-X	Category 02: Protected from sources of heat.	See glossary of terms in appendix B.	0425	
0426	PROJECTILES with burster or expelling charge	1.2 F	-	-	-	0	EO	P130	-	-	-	-	-	F-8, S-X	Category 05: Protected from sources of heat.	See glossary of terms in appendix B.	0426	
0427	PROJECTILES with burster or expelling charge	1.4 F	-	-	-	0	EO	P130	-	-	-	-	-	F-8, S-X	Category 05: Protected from sources of heat.	See glossary of terms in appendix B.	0427	
0428	ARTICLES, PYROTECHNIC for technical purposes	1.1 G	-	-	-	0	EO	P135	-	-	-	-	-	F-8, S-X	Category 03: Protected from sources of heat.	See glossary of terms in appendix B.	0428	
0429	ARTICLES, PYROTECHNIC for technical purposes	1.2 G	-	-	-	0	EO	P135	-	-	-	-	-	F-8, S-X	Category 03: Protected from sources of heat.	See glossary of terms in appendix B.	0429	
0430	ARTICLES, PYROTECHNIC for technical purposes	1.3 G	-	-	-	0	EO	P135	-	-	-	-	-	F-8, S-X	Category 03: Protected from sources of heat.	See glossary of terms in appendix B.	0430	
0431	ARTICLES, PYROTECHNIC for technical purposes	1.4 G	-	-	-	0	EO	P135	-	-	-	-	-	F-8, S-X	Category 02: Protected from sources of heat.	See glossary of terms in appendix B.	0431	
0432	ARTICLES, PYROTECHNIC for technical purposes	1.4 S	-	-	-	0	EO	P135	-	-	-	-	-	F-8, S-X	Category 01: Protected from sources of heat.	See glossary of terms in appendix B.	0432	
0433	POWDER CAKE (POWDER PASTE), WETTED with not less than 17% alcohol, by mass	1.1 C	-	-	-	266	EO	P111	-	-	-	-	-	F-8, S-Y	Category 04: Protected from sources of heat.	See glossary of terms in appendix B.	0433	
0434	PROJECTILES with burster or expelling charge	1.2 G	-	-	-	0	EO	P130 LP101	P67 L1	-	-	-	-	F-8, S-X	Category 03: Protected from sources of heat.	See glossary of terms in appendix B.	0434	
0435	PROJECTILES with burster or expelling charge	1.4 G	-	-	-	0	EO	P130 LP101	P67 L1	-	-	-	-	F-8, S-X	Category 02: Protected from sources of heat.	See glossary of terms in appendix B.	0435	
0436	ROCKETS with expelling charge	1.2 C	-	-	-	0	EO	P130 LP101	P67 L1	-	-	-	-	F-8, S-X	Category 04: Protected from sources of heat.	See glossary of terms in appendix B.	0436	

UN No. (1)	PSN (2)	Class No./Div (3)	Subsidiary Risk(s) (4)	Packing Group (5)	Special Provisions (6)	Limited quantities (7a)	Excepted quantities (7b)	Packing		IBC	
								Instruc-tions (8)	Provisions (9)	Instruc-tions (10)	Provisions (11)
3.1.2		2.0	2.0	2.0, 1.3	3.3	3.4	3.5	4.1, 4	4.1, 4	4.1, 4	

0437 ROCKETS with expelling charge

1.3 C - - - - 0 ED P130 LP101

P667 LI

Category 04. Protected from sources of heat.

See glossary of terms in appendix B.

0437

0438 ROCKETS with expelling charge

1.4 C - - - - 0 ED P130 LP101

P667 LI

Category 02. Protected from sources of heat.

See glossary of terms in appendix B.

0438

0439 CHARGES, SHAPED without detonator

1.2 D - - - - 0 ED P137 PP70

Category 04. Protected from sources of heat.

See glossary of terms in appendix B.

0439

0440 CHARGES, SHAPED without detonator

1.4 D - - - - 0 ED P137 PP70

Category 02. Protected from sources of heat.

See glossary of terms in appendix B.

0440

0441 CHARGES, SHAPED without detonator

1.4 S - - - - 347 0 ED P137 PP70

Category 01. Protected from sources of heat.

See glossary of terms in appendix B.

0441

0442 CHARGES, EXPLOSIVE, COMMERCIAL without detonator

1.1 D - - - - 0 ED P137

Category 04. Protected from sources of heat.

See glossary of terms in appendix B.

0442

0443 CHARGES, EXPLOSIVE, COMMERCIAL without detonator

1.2 D - - - - 0 ED P137

Category 04. Protected from sources of heat.

See glossary of terms in appendix B.

0443

0444 CHARGES, EXPLOSIVE, COMMERCIAL without detonator

1.4 D - - - - 0 ED P137

Category 02. Protected from sources of heat.

See glossary of terms in appendix B.

0444

0445 CHARGES, EXPLOSIVE, COMMERCIAL without detonator

1.4 S - - - - 347 0 ED P137

Category 01. Protected from sources of heat.

See glossary of terms in appendix B.

0445

0446 CASES, COMBUSTIBLE, EMPTY, WITHOUT PRIMER

1.4 C - - - - 0 ED P136

Category 02. Protected from sources of heat.

See glossary of terms in appendix B.

0446

0447 CASES, COMBUSTIBLE, EMPTY, WITHOUT PRIMER

1.3 C - - - - 0 ED P136

Category 04. Protected from sources of heat.

See glossary of terms in appendix B.

0447

0448 5-MERCAPTOTETRAZOL-1-ACETIC ACID

1.4 C - - - - 0 ED P114 (b)

Category 02. Protected from sources of heat.

Substance.

0448

0449 TORPEDOIS, LIQUID-FUELLED with or without bursting charge

1.1 J - - - - 0 ED P101

Category 05. "Separated from" division 1.4 and "Separated longitudinally by an intervening complete compartment or hold from" divisions 1.1, 1.2, 1.3, 1.5 and 1.6 except from explosives of compatibility group J. Protected from sources of heat.

See glossary of terms in appendix B.

0449

0450 TORPEDOIS, LIQUID-FUELLED with inert head

1.3 J - - - - 0 ED P101

Category 05. "Separated from" division 1.4 and "Separated longitudinally by an intervening complete compartment or hold from" divisions 1.1, 1.2, 1.3, 1.5 and 1.6 except from explosives of compatibility group J. Protected from sources of heat.

See glossary of terms in appendix B.

0450

0451 TORPEDOIS with bursting charge

1.1 D - - - - 0 ED P130 LP101

Category 04. Protected from sources of heat.

See glossary of terms in appendix B.

0451

UN No. (1)	Provisions (14)	EIMS (15)	Stowage and Segregation (16)	Properties and Observations (17)	UN No. (18)
7.1 to 7.7	4.2.5 4.3	5.4.5.2 7.8	7.1 to 7.7		

Category 04. Protected from sources of heat.

See glossary of terms in appendix B.

0437

Category 02. Protected from sources of heat.

See glossary of terms in appendix B.

0438

Category 04. Protected from sources of heat.

See glossary of terms in appendix B.

0439

Category 02. Protected from sources of heat.

See glossary of terms in appendix B.

0440

Category 01. Protected from sources of heat.

See glossary of terms in appendix B.

0441

Category 04. Protected from sources of heat.

See glossary of terms in appendix B.

0442

Category 04. Protected from sources of heat.

See glossary of terms in appendix B.

0443

Category 02. Protected from sources of heat.

See glossary of terms in appendix B.

0444

Category 01. Protected from sources of heat.

See glossary of terms in appendix B.

0445

Category 02. Protected from sources of heat.

See glossary of terms in appendix B.

0446

Category 04. Protected from sources of heat.

See glossary of terms in appendix B.

0447

Category 02. Protected from sources of heat.

Substance.

0448

Category 05. "Separated from" division 1.4 and "Separated longitudinally by an intervening complete compartment or hold from" divisions 1.1, 1.2, 1.3, 1.5 and 1.6 except from explosives of compatibility group J. Protected from sources of heat.

See glossary of terms in appendix B.

0449

Category 05. "Separated from" division 1.4 and "Separated longitudinally by an intervening complete compartment or hold from" divisions 1.1, 1.2, 1.3, 1.5 and 1.6 except from explosives of compatibility group J. Protected from sources of heat.

See glossary of terms in appendix B.

0450

Category 04. Protected from sources of heat.

See glossary of terms in appendix B.

0451

UN No. (1)	PSN (2)	Class No. (3)	Subsidiary Risk(s) (4)	Packing Group (5)	Special Provisions (6)	Limited quantities (7a)	Excepted quantities (7b)	Packing		IBC	
								Institutions (8)	Provisions (9)	Institutions (10)	Provisions (11)
3.1.2		2.0	2.0	2.0, 1.3	3.3	3.4	3.5	4.1, 4	4.1, 4	4.1, 4	4.1, 4
1.4 G	-	-	-	-	-	0	ED	P1, 41	-	-	-

UN No. (16)	Properties and Observations (17)	Portable tanks and bulk containers		Stowage and Segregation (16)	EIMS (15)
		Tank instructions (15)	Provisions (14)		
7.1 to 7.7		4.2.5 4.3	4.2.5	5.4, 5.2 7.8	(15)
Category 02. Protected from sources of heat.	See glossary of terms in appendix B.	-	-	-	F-B, S-X

0452	GRENADS, PRACTICE hand or rifle	1.4 G	-	-	-	0	ED	P1, 41	-	-	-	Category 02. Protected from sources of heat.	See glossary of terms in appendix B.	0452
0453	ROCKETS, LINE-THROWING	1.4 G	-	-	-	0	ED	P1, 30	-	-	-	Category 02. Protected from sources of heat.	See glossary of terms in appendix B.	0453
0454	IGNITERS	1.4 S	-	-	-	0	ED	P1, 42	-	-	-	Category 01. Protected from sources of heat.	See glossary of terms in appendix B.	0454
0455	DETONATORS, NON-ELECTRIC for blasting	1.4 S	-	-	347	0	ED	P1, 31	PR6, 8	-	-	Category 01. Protected from sources of heat.	See glossary of terms in appendix B.	0455
0456	DETONATORS, ELECTRIC for blasting	1.4 S	-	-	347	0	ED	P1, 31	-	-	-	Category 01. Protected from sources of heat.	See glossary of terms in appendix B.	0456
0457	CHARGES, BURSTING, PLASTICS BONDED	1.1 D	-	-	-	0	ED	P1, 30	-	-	-	Category 04. Protected from sources of heat.	See glossary of terms in appendix B.	0457
0458	CHARGES, BURSTING, PLASTICS BONDED	1.2 D	-	-	-	0	ED	P1, 30	-	-	-	Category 04. Protected from sources of heat.	See glossary of terms in appendix B.	0458
0459	CHARGES, BURSTING, PLASTICS BONDED	1.4 D	-	-	-	0	ED	P1, 30	-	-	-	Category 02. Protected from sources of heat.	See glossary of terms in appendix B.	0459
0460	CHARGES, BURSTING, PLASTICS BONDED	1.4 S	-	-	347	0	ED	P1, 30	-	-	-	Category 01. Protected from sources of heat.	See glossary of terms in appendix B.	0460
0461	COMPONENTS, EXPLOSIVE TRAIN, N.O.S.	1.1 B	-	-	178 274	0	ED	P1, 01	-	-	-	Category 05. Protected from sources of heat.	See glossary of terms in appendix B.	0461
0462	ARTICLES, EXPLOSIVE, N.O.S.	1.1 C	-	-	178 274	0	ED	P1, 01	-	-	-	Category 04. Protected from sources of heat.	-	0462
0463	ARTICLES, EXPLOSIVE, N.O.S.	1.1 D	-	-	178 274	0	ED	P1, 01	-	-	-	Category 04. Protected from sources of heat.	-	0463
0464	ARTICLES, EXPLOSIVE, N.O.S.	1.1 E	-	-	178 274	0	ED	P1, 01	-	-	-	Category 04. Protected from sources of heat.	-	0464
0465	ARTICLES, EXPLOSIVE, N.O.S.	1.1 F	-	-	178 274	0	ED	P1, 01	-	-	-	Category 05. Protected from sources of heat.	-	0465
0466	ARTICLES, EXPLOSIVE, N.O.S.	1.2 C	-	-	178 274	0	ED	P1, 01	-	-	-	Category 04. Protected from sources of heat.	-	0466
0467	ARTICLES, EXPLOSIVE, N.O.S.	1.2 D	-	-	178 274	0	ED	P1, 01	-	-	-	Category 04. Protected from sources of heat.	-	0467
0468	ARTICLES, EXPLOSIVE, N.O.S.	1.2 E	-	-	178 274	0	ED	P1, 01	-	-	-	Category 04. Protected from sources of heat.	-	0468

TSFS 2015:66  
Bilaga 1

UN No. (1)	PSN (2)	Class No. (3)	Subsidiary Risk(s) (4)	Packing Group (5)	Special Provisions (6)	Limited quantities (7a)	Excepted quantities (7b)	Packing		IBC		Tank instructions (15)	Provisors (14)	EMS (15)	Stowage and Segregation (16)	Properties and Observations (17)	UN No. (18)
								Institutions (8)	Provisions (9)	Institutions (10)	Provisions (11)						
	3.1.2	2.0	2.0	2.0, 1.3	3.3	3.4	3.5	4.1, 4	4.1, 4	4.1, 4	4.1, 4	4.2, 5 4.3	4.2, 5	5.4, 5.2 7.8	7.1 to 7.7		
0469	ARTICLES, EXPLOSIVE, N.O.S.	1.2 F	-	-	178 274	0	ED	P1.01	-	-	-	-	-	F-B, S-X	Category 05. Protected from sources of heat.	-	0469
0470	ARTICLES, EXPLOSIVE, N.O.S.	1.3 C	-	-	178 274	0	ED	P1.01	-	-	-	-	-	F-B, S-X	Category 04. Protected from sources of heat.	-	0470
0471	ARTICLES, EXPLOSIVE, N.O.S.	1.4 E	-	-	178 274	0	ED	P1.01	-	-	-	-	-	F-B, S-X	Category 03. Protected from sources of heat.	-	0471
0472	ARTICLES, EXPLOSIVE, N.O.S.	1.4 F	-	-	178 274	0	ED	P1.01	-	-	-	-	-	F-B, S-X	[Category 05. Protected from sources of heat.	-	0472
0473	SUBSTANCES, EXPLOSIVE, N.O.S.	1.1 A	-	-	178 274	0	ED	P1.01	-	-	-	-	-	F-B, S-Y	Category 05. Protected from sources of heat.	-	0473
0474	SUBSTANCES, EXPLOSIVE, N.O.S.	1.1 C	-	-	178 274	0	ED	P1.01	-	-	-	-	-	F-B, S-Y	Category 04. Protected from sources of heat.	-	0474
0475	SUBSTANCES, EXPLOSIVE, N.O.S.	1.1 D	-	-	178 274	0	ED	P1.01	-	-	-	-	-	F-B, S-Y	Category 04. Protected from sources of heat.	-	0475
0476	SUBSTANCES, EXPLOSIVE, N.O.S.	1.1 G	-	-	178 274	0	ED	P1.01	-	-	-	-	-	F-B, S-Y	Category 03. Protected from sources of heat.	-	0476
0477	SUBSTANCES, EXPLOSIVE, N.O.S.	1.3 C	-	-	178 274	0	ED	P1.01	-	-	-	-	-	F-B, S-Y	Category 04. Protected from sources of heat.	-	0477
0478	SUBSTANCES, EXPLOSIVE, N.O.S.	1.3 G	-	-	178 274	0	ED	P1.01	-	-	-	-	-	F-B, S-Y	Category 03. Protected from sources of heat.	-	0478
0479	SUBSTANCES, EXPLOSIVE, N.O.S.	1.4 C	-	-	178 274	0	ED	P1.01	-	-	-	-	-	F-B, S-Y	Category 02. Protected from sources of heat.	-	0479
0480	SUBSTANCES, EXPLOSIVE, N.O.S.	1.4 D	-	-	178 274	0	ED	P1.01	-	-	-	-	-	F-B, S-Y	Category 02. Protected from sources of heat.	-	0480
0481	SUBSTANCES, EXPLOSIVE, N.O.S.	1.4 S	-	-	178 274	0	ED	P1.01	-	-	-	-	-	F-B, S-Y	Category 01. Protected from sources of heat.	-	0481
0482	SUBSTANCES, EXPLOSIVE, VERY INSENSITIVE (SUBSTANCES, EX, N.O.S.)	1.5 D	-	-	178 274	0	ED	P1.01	-	-	-	-	-	F-B, S-Y	Category 03. Protected from sources of heat.	-	0482
0483	CYCLOTRIMETHYLENETRANTRAMINE (CYCLONITE; HEXOGEN; RDX); DESENSITIZED	1.1 D	-	-	-	0	ED	P1.1.2 (b) or (c)	-	-	-	-	-	F-B, S-Y	Category 04. Protected from sources of heat.	Substance. Mass detonating explosive which will become more sensitive if the wetting or desensitizing agents are lost.	0483
0484	CYCLOTRIMETHYLENETRANTRAMINE (OCTOGEN; HMX); DESENSITIZED	1.1 D	-	-	-	0	ED	P1.1.2 (b) or (c)	-	-	-	-	-	F-B, S-Y	Category 04. Protected from sources of heat.	Substance. Mass detonating explosive which will become more sensitive if the wetting or desensitizing agents are lost.	0484
0485	SUBSTANCES, EXPLOSIVE, N.O.S.	1.4 C	-	-	178 274	0	ED	P1.01	-	-	-	-	-	F-B, S-Y	Category 03. Protected from sources of heat.	-	0485



UN No. (1)	PSN (2)	Class No. (3)	Subsidiary Risk(s) (4)	Packing Group (5)	Special Provisions (6)	Limited quantities (7a)	Excepted quantities (7b)	Packing		IBC		Portable tanks and bulk containers	EIMS (15)	Stowage and Segregation (16)	UN No. (18)	
								Institutions (8)	Provisions (9)	Institutions (10)	Provisions (11)					Tank instructions (12)
3.1.2		2.0	2.0	2.0	2.0	3.3	3.4	3.5	4.1.4	4.1.4	4.1.4	4.2.5 4.3	4.2.5 7.8	7.1 to 7.7	(17)	
0486 ARTICLES, EXPLOSIVE, EXTREMELY INSENSITIVE (ARTICLES; ED)																
1.6 N		-	-	-	-	0	ED	P1.01	-	-	-	-	F-B, S-X	Category 03. Protected from sources of heat.	See glossary of terms in appendix B.	0486
0487 SIGNALS, SMOKE																
1.3 G		-	-	-	-	0	ED	P1.35	-	-	-	-	F-B, S-X	Category 03. Protected from sources of heat.	See glossary of terms in appendix B.	0487
0488 AMMUNITION, PRACTICE																
1.3 G		-	-	-	-	0	ED	P1.30 LP1.01	PP57 L1	-	-	-	F-B, S-X	Category 03. Protected from sources of heat.	See glossary of terms in appendix B.	0488
0489 DINITROGLYCEROL (DNG/L)																
1.1 D		-	-	-	-	0	ED	P1.12 (b) or (c)	-	-	-	-	F-B, S-Y	Category 04. Protected from sources of heat.	Substance.	0489
0490 NITROTRIAZOLONE (NTO)																
1.1 D		-	-	-	-	0	ED	P1.12 (b) or (c)	-	-	-	-	F-B, S-Y	Category 04. Protected from sources of heat.	Substance.	0490
0491 CHARGES, PROPELLING																
1.4 C		-	-	-	-	0	ED	P1.43	PP7.6	-	-	-	F-B, S-X	Category 02. Protected from sources of heat.	See glossary of terms in appendix B.	0491
0492 SIGNALS, RAILWAY TRACK, EXPLOSIVE																
1.3 G		-	-	-	-	0	ED	P1.35	-	-	-	-	F-B, S-X	Category 03. Protected from sources of heat.	See glossary of terms in appendix B.	0492
0493 SIGNALS, RAILWAY TRACK, EXPLOSIVE																
1.4 G		-	-	-	-	0	ED	P1.35	-	-	-	-	F-B, S-X	Category 02. Protected from sources of heat.	See glossary of terms in appendix B.	0493
0494 JET PERFORATING GUNS, CHARGED oil well, without detonator																
1.4 D		-	-	-	-	0	ED	P1.01	-	-	-	-	F-B, S-X	Category 02. Protected from sources of heat.	See glossary of terms in appendix B.	0494
0495 PROPELLANT, LIQUID																
1.3 C		-	-	-	224	0	ED	P1.15	PP53 PP54 PP57 PP58	-	-	-	F-B, S-Y	Category 04. Protected from sources of heat.	See glossary of terms in appendix B.	0495
0496 OCTONAL																
1.1 D		-	-	-	-	0	ED	P1.12 (b) or (c)	-	-	-	-	F-B, S-Y	Category 04. Protected from sources of heat.	Substance. Mixtures of mass detonating explosives.	0496
0497 PROPELLANT, LIQUID																
1.1 C		-	-	-	224	0	ED	P1.15	PP53 PP54 PP57 PP58	-	-	-	F-B, S-Y	Category 04. Protected from sources of heat.	See glossary of terms in appendix B.	0497
0498 PROPELLANT, SOLID																
1.1 C		-	-	-	-	0	ED	P1.14 (b)	-	-	-	-	F-B, S-Y	Category 04. Protected from sources of heat.	See glossary of terms in appendix B.	0498
0499 PROPELLANT, SOLID																
1.3 C		-	-	-	-	0	ED	P1.14 (b)	-	-	-	-	F-B, S-Y	Category 04. Protected from sources of heat.	See glossary of terms in appendix B.	0499
0500 DETONATOR ASSEMBLIES, NON-ELECTRIC for blasting																
1.4.5		-	-	-	347	0	ED	P1.31	-	-	-	-	F-B, S-X	Category 01. Protected from sources of heat.	See glossary of terms in appendix B.	0500

# TSFS 2015:66 Bilaga 1

Portable tanks and bulk containers	
Tank instructions	Provisions
(15)	(14)
4.2.5 4.3	4.2.5 7.8

UN No. (1)	PSN (2)	Class No. (3)	Subsidiary Risk(s) (4)	Packing Group (5)	Special Provisions (6)	Limited quantities (7a)	Excepted quantities (7b)	Packing		IBC	
								Instructions (8)	Provisions (9)	Instructions (10)	Provisions (11)
3.1.2		2.0	2.0	2.0	1.3	3.4	3.5	4.1.4	4.1.4	4.1.4	4.1.4

UN No. (1)	PSN (2)	Class No. (3)	Subsidiary Risk(s) (4)	Packing Group (5)	Special Provisions (6)	Limited quantities (7a)	Excepted quantities (7b)	Instructions (8)	Provisions (9)	Instructions (10)	Provisions (11)	EMSS (15)	Stowage and Segregation (16)	Properties and Observations (17)	UN No. (18)
0501	PROPPELLANT, SOLID	1.4 C	-	-	-	0	EO	P11.4 (b)	-	-	-	F-B, S-Y	Category 02. Protected from sources of heat.	See glossary of terms in appendix B.	0501
0502	ROCKETS with inert head	1.2 C	-	-	-	0	EO	P1.30 LP101	PH57 LI	-	-	F-B, S-X	Category 04. Protected from sources of heat.	See glossary of terms in appendix B.	0502
0503	AIR BAG INFLATORS or AIR BAG MODULES or SEAT-BELT PRETENSIONERS	1.4 C	-	-	235 289	0	EO	P1.35	-	-	-	F-B, S-X	Category 02. Protected from sources of heat.	See glossary of terms in appendix B.	0503
0504	1H-TETRAZOLE	1.1 D	-	-	-	0	EO	P11.2 (c)	PM4.8	-	-	F-B, S-Y	Category 04. Protected from sources of heat.	Substance.	0504
0505	SIGNALS, DISTRESS, ship	1.4C	-	-	-	0	EO	P1.35	-	-	-	F-B, S-X	Category 02. Protected from sources of heat.	See glossary of terms in appendix B.	0505
0506	SIGNALS, DISTRESS, ship	1.4S	-	-	-	0	EO	P1.35	-	-	-	F-B, S-X	Category 01. Protected from sources of heat.	See glossary of terms in appendix B.	0506
0507	SIGNALS, SMOKE	1.4S	-	-	-	0	EO	P1.35	-	-	-	F-B, S-X	Category 01. Protected from sources of heat.	See glossary of terms in appendix B.	0507
0508	1-HYDROXYBENZOTRIAZOLE, ANHYDROUS, dry or wetted with less than 20% water, by mass	1.3C	-	-	-	0	EO	P114(b) PP50	PM4.8	-	-	F-B, S-Y	Category 04. Protected from sources of heat.	Substance.	0508
0509	POWDER, SMOKELESS	1.4C	-	-	-	0	EO	P114(b)	PM4.8	-	-	F-B, S-Y	Category 02. Protected from sources of heat.	See glossary of terms in appendix B.	0509
1001	ACETYLENE, DISSOLVED	2.1	-	-	-	0	EO	P200	-	-	-	E, D, S, U	Category D. Protected from sources of heat, fire, and oxidizing agents. Separated from chlorine.	Flammable gas with slight odour. Explosive limits: 2.1% to 80% lighter than air (0.6). Heating should be avoided, since these conditions may result in delayed explosion. Empty cylinders should be carried with the same precautions as filled cylinders.	1001
1002	AIR, COMPRESSED	2.2	-	-	-	1.20m <sup>l</sup>	EI	P200	-	-	-	F-C, S-V	Category A.	Non-flammable gas.	1002
1003	AIR, REFRIGERATED LIQUID	2.2	5.1	-	-	0	EO	P203	-	-	-	T75 TP22	Category D.	Liquefied, non-flammable gas. Strong oxidizing agent. Mixtures of liquid air with combustible materials or oils may explode. May ignite organic materials.	1003
1005	AMMONIA, ANHYDROUS	2.3	8	-	23	0	EO	P200	-	-	-	T50	Category D. Clear of living quarters. "Separated from" chlorine. "Separated from" acids.	Liquefied, non-flammable, toxic and corrosive gas with a pungent odour. Lighter than air (0.6). Suffocating in low concentrations. Even though this substance has a flammability hazard, it only exhibits such hazard under extreme fire conditions. It is extremely irritating to skin, eyes and mucous membranes.	1005
1006	ARGON, COMPRESSED	2.2	-	-	-	120 m <sup>l</sup>	EI	P200	-	-	-	F-C, S-V	Category A.	Inert gas. Heavier than air (1.4).	1006
1008	BORON TRIFLUORIDE	2.3	8	-	-	0	EO	P200	-	-	-	F-C, S-U	Category D. Clear of living quarters.	Non-flammable, toxic and corrosive gas. Forms dense white corrosive fumes in moist air. Reacts violently with water, evolving hydrogen fluoride, an irritating and corrosive gas apparent as white fumes. In the presence of water, it forms a highly corrosive and irritating solution (2.3.5). Highly irritating to skin, eyes and mucous membranes.	1008
1009	BROMOTRIFLUOROMETHANE (REFRIGERANT GAS R 13B1)	2.2	-	-	-	120 m <sup>l</sup>	EI	P200	-	-	-	F-C, S-V	Category A.	Liquefied, non-flammable gas with a slight odour. Much heavier than air (5.2).	1009

UN No. (1)	PSN (2)	Class No. (3)	Subsidiary Risk(s) (4)	Packing Group (5)	Special Provisions (6)	Limited quantities (7a)	Excepted quantities (7b)	Packing		IBC		Portable tanks and bulk containers	EMs (15)	Stowage and Segregation (16)	Properties and Observations (17)	UN No. (18)
								Institutions (8)	Provisions (9)	Institutions (10)	Provisions (11)					
	3.1.2	2.0	2.0	2.0	3.3	3.4	3.5	4.1.4	4.1.4	4.1.4	4.1.4	T50	-	F-D, S-U	Category B. Clear of living quarters. Liquefied, flammable gas with an unpleasant odour. Explosive limits: 2% to 1.0% 1.2% heavier than air (1.34).	1010
1010 BUTADIENE, STABILIZED or BUTADIENES AND HYDROCARBON MIXTURE, STABILIZED, containing more than 40% butadienes																
1011	BUTANE	2.1	-	-	-	0	EO	P200	-	-	-	T50	-	F-D, S-U	Category B. Clear of living quarters. Liquefied, flammable gas with an unpleasant odour. Explosive limits: 2% to 1.0% 1.2% heavier than air (1.34).	1011
1012	BUTYLENE	2.1	-	-	-	0	EO	P200	-	-	-	T50	-	F-D, S-U	Category E. Clear of living quarters. Flammable hydrocarbon gas. Explosive limits: 1.8% to 8.4%. Heavier than air (2.11).	1012
1013	CARBON DIOXIDE	2.2	-	-	-	120 mf	E1	P200	-	-	-	T50	-	F-C, S-V	Category A. Liquefied, non-flammable gas. Heavier than air (1.5). Cannot remain in the liquid state above 31°C.	1013
1016	CARBON MONOXIDE, COMPRESSED	2.3	2.1	-	-	0	EO	P200	-	-	-	T50	-	F-D, S-U	Category D. Clear of living quarters. Flammable, toxic, odourless gas. Explosive limits: 12% to 75%. Slightly lighter than air (0.97).	1016
1017	CHLORINE	2.3	5.1/8 P	-	-	0	EO	P200	-	-	-	T50	TP19	F-C, S-U	Category D. Clear of living quarters. Segregation as for class 5.1 but 'Separated from' Class 7. Non-flammable, toxic and corrosive yellow gas with a pungent odour. Corrosive to glass and to most metals. Much heavier than air (2.4). Highly irritating to skin, eyes and mucous membranes. Powerful oxidant which may cause fire.	1017
1018	CHLORODIFLUOROMETHANE (REFRIGERANT GAS R 22)	2.2	-	-	-	120 mf	E1	P200	-	-	-	T50	-	F-C, S-V	Category A. Liquefied, non-flammable gas with a chloroform-like odour. Much heavier than air (3.0).	1018
1020	CHLOROPENTAFLUOROETHANE (REFRIGERANT GAS R 115)	2.2	-	-	-	120 mf	E1	P200	-	-	-	T50	-	F-C, S-V	Category A. Liquefied, non-flammable gas. Much heavier than air (5.4).	1020
1021	1-CHLORO-1,1,2,2-TETRAFLUOROETHANE (REFRIGERANT GAS R 124)	2.2	-	-	-	120 mf	E1	P200	-	-	-	T50	-	F-C, S-V	Category A. Liquefied, non-flammable gas. Much heavier than air (4.7).	1021
1022	CHLOROTRIFLUOROMETHANE (REFRIGERANT GAS R 13)	2.2	-	-	-	120 mf	E1	P200	-	-	-	T50	-	F-C, S-V	Category A. Liquefied, non-flammable gas. Much heavier than air (3.6). Cannot remain in the liquid state above 29°C.	1022
1023	COAL GAS, COMPRESSED	2.3	2.1	-	-	0	EO	P200	-	-	-	T50	-	F-D, S-U	Category D. Clear of living quarters. Flammable, toxic gas. Explosive limits: 4.5% to 40%. Much lighter than air (0.4 to 0.6).	1023
1026	CYANOGEN	2.3	2.1	-	-	0	EO	P200	-	-	-	T50	-	F-D, S-U	Category D. Clear of living quarters. Liquefied, flammable, toxic gas with a pungent odour. Explosive limits: 6.6% to 43%. Heavier than air (1.9).	1026
1027	CYCLOPROPANE	2.1	-	-	-	0	EO	P200	-	-	-	T50	-	F-D, S-U	Category E. Clear of living quarters. Flammable hydrocarbon gas. Heavier than air.	1027
1028	DICHLORODIFLUOROMETHANE (REFRIGERANT GAS R 12)	2.2	-	-	-	120 mf	E1	P200	-	-	-	T50	-	F-C, S-V	Category A. Liquefied, non-flammable gas. Much heavier than air (4.2).	1028
1029	DICHLORODIFLUOROMETHANE (REFRIGERANT GAS R 21)	2.2	-	-	-	120 mf	E1	P200	-	-	-	T50	-	F-C, S-V	Category A. Liquefied, non-flammable gas with a chloroform-like odour. Much heavier than air (3.6). Boiling point: 9°C.	1029
1030	1,1-DIFLUOROETHANE (REFRIGERANT GAS R 152a)	2.1	-	-	-	0	EO	P200	-	-	-	T50	-	F-D, S-U	Category B. Clear of living quarters. Flammable gas. Explosive limits: 5% to 17%. Much heavier than air (2.3).	1030
1032	DIMETHYLAMINE, ANHYDROUS	2.1	-	-	-	0	EO	P200	-	-	-	T50	-	F-D, S-U	Category D. Clear of living quarters. Liquefied, flammable gas with an ammonia-like odour. Heavier than air (1.6). Boiling point: 7°C. Suffocating in low concentrations.	1032

**TSFS 2015:66**  
**Bilaga 1**

UN No. (1)	PSN (2)	Class No. (3)	Subsidiary Risk(s) (4)	Packing Group (5)	Special Provisions (6)	Limited quantities (7a)	Excepted quantities (7b)	Packing		IBC		Tank instructions (15)	Provisions (14)	EMs (15)	Stowage and Segregation (16)	Properties and Observations (17)	UN No. (18)
								Institutions (8)	Provisions (9)	Institutions (10)	Provisions (11)						
	3.1.2	2.0	2.0	2.0	1.3	3.3	3.4	3.5	4.1, 4	4.1, 4	4.1, 4	4.2, 5	4.2, 5	5.4, 5.2	7.1 to 7.7		
1033	DIMETHYL ETHER	2.1	-	-	-	0	EO	P200	-	-	-	T50	-	F-D, S-U	Category B. Clear of living quarters. Flammable gas with a chloroform-like odour. Heavier than air (1.6).		1033
1035	ETHANE	2.1	-	-	-	0	EO	P200	-	-	-	-	-	F-D, S-U	Category E. Clear of living quarters. Flammable gas. Explosive limits: 3% to 16%. Slightly heavier than air (1.05).		1035
1036	ETHYLAMINE	2.1	-	-	912	0	EO	P200	-	-	-	T50	-	F-D, S-U	Category D. Clear of living quarters. Liquefied, flammable gas with an ammonia-like odour. Explosive limits: 3.5% to 14%. Heavier than air (1.6). Boiling point: 17°C.		1036
1037	ETHYL CHLORIDE	2.1	-	-	-	0	EO	P200	-	-	-	T50	-	F-D, S-U	Category B. Clear of living quarters. Liquefied, flammable gas. Explosive limits: 3.5% to 15%. Much heavier than air (2.2). Boiling point: 13°C.		1037
1038	ETHYLENE REFRIGERATED LIQUID	2.1	-	-	-	0	EO	P203	-	-	-	T75	TP5	F-D, S-U	Category D. Clear of living quarters. Liquefied, flammable gas. Explosive limits: 3% to 34%. Lighter than air (0.98).		1038
1039	ETHYL METHYL ETHER	2.1	-	-	-	0	EO	P200	-	-	-	-	-	F-D, S-U	Category B. Clear of living quarters. Liquefied, flammable gas. Explosive limits: 2% to 10%. Much heavier than air (2.1). Boiling point: 11°C.		1039
1040	ETHYLENE OXIDE or ETHYLENE OXIDE WITH NITROGEN up to a total pressure of 1 MPa (10 bar) at 50°C	2.3	2.1	-	342	0	EO	P200	-	-	-	T50	TP20 TP90	F-D, S-U	Category D. Clear of living quarters. Liquefied, flammable, toxic gases with an ether-like odour. Heavier than air (1.5). Boiling point: 11°C.		1040
1041	ETHYLENE OXIDE AND CARBON DIOXIDE MIXTURE with more than 9% but not more than 87% ethylene oxide	2.1	-	-	-	0	EO	P200	-	-	-	T50	-	F-D, S-U	Category B. Clear of living quarters. Liquefied, flammable gas with an ether-like odour. Heavier than air (1.5).		1041
1043	FERTILIZER AMMONIATING SOLUTION with free ammonia	2.2	-	-	-	120 ml <sup>f</sup>	E1	P200	-	-	-	-	-	F-C, S-V	Category E. Clear of living quarters. Non-flammable aqueous solution of ammonium nitrate, calcium nitrate, urea and their mixtures containing ammonia gas. Emits toxic vapours of ammonia.		1043
1044	FIRE EXTINGUISHERS with compressed or liquefied gas	2.2	-	-	225	120 ml <sup>f</sup>	EO	P003	-	-	-	-	-	F-C, S-V	Category A. Fire extinguishers, containing compressed or liquefied gases under pressure above 175 kPa for expelling fire-extinguishing contents.		1044
1045	FLUORINE, COMPRESSED	2.3	5.1/8	-	-	0	EO	P200	-	-	-	-	-	F-C, S-W	Category D. Clear of living quarters. Non-flammable, toxic and corrosive pale yellowish gas with a pungent odour. Powerful oxidant which may cause fire. Reacts with water or moist air to produce toxic and corrosive fumes. Corrosive to glass and to most metals. Will explode when mixed with hydrogen. Heavier than air (1.3). Highly irritating to skin, eyes and mucous membranes.		1045
1046	HELIUM, COMPRESSED	2.2	-	-	-	120 ml <sup>f</sup>	E1	P200	-	-	-	-	-	F-C, S-V	Category A. Inert gas. Much lighter than air (0.14).		1046
1048	HYDROGEN BROMIDE, ANHYDROUS	2.3	8	-	-	0	EO	P200	-	-	-	-	-	F-C, S-U	Category D. Clear of living quarters. Non-flammable, toxic and corrosive gas with a pungent odour. Highly corrosive in the presence of water. Much heavier than air (3.6). Highly irritating to the skin, eyes and mucous membranes.		1048
1049	HYDROGEN, COMPRESSED	2.1	-	-	-	0	EO	P200	-	-	-	-	-	F-D, S-U	Category E. Clear of living quarters. Flammable, odourless gas. Explosive limits: 4% to 75%. Much lighter than air (0.07).		1049
1050	HYDROGEN CHLORIDE, ANHYDROUS	2.3	8	-	-	0	EO	P200	-	-	-	-	-	F-C, S-U	Category D. Clear of living quarters. Non-flammable, toxic and corrosive colourless gas with a pungent odour. Highly corrosive in the presence of water. Heavier than air (1.3). Highly irritating to skin, eyes and mucous membranes.		1050
1051	HYDROGEN CYANIDE, STABILIZED containing less than 3% water	6.1	3	1	-	0	ES	P200	-	-	-	-	-	F-E, S-D	Category D. Clear of living quarters. Very volatile, colourless flammable liquid, evolving extremely toxic fumes on contact with water. Boiling point: 26°C. Flashpoint: 19°C. Miscible with water. Highly toxic if swallowed. Do skin contact or by inhalation.		1051

UN No. (1)	PSN (2)	Class No. (3)	Subsidiary Risk(s) (4)	Packing Group (5)	Special Provisions (6)	Limited quantities (7a)	Excepted quantities (7b)	Packing			IBC	
								Instituted quantities (8)	Institutions (9)	Provisions (10)	Institutions (11)	Provisions (11)
3.1.2		2.0	2.0	2.0, 1.3	3.3	3.4	3.5	4.1, 4	4.1, 4	4.1, 4	4.1, 4	

Portable tanks and bulk containers		EMs (15)	Storage and Segregation (16)	UN No. (17)
Tank instructions (15)	Provisions (14)			
4.2.5 4.3	4.2.5	5.4, 5.2 7.8	7.1 to 7.7	(17)

UN No.	PSN	Class No.	Subsidiary Risk(s)	Packing Group	Special Provisions	Limited quantities	Excepted quantities	Instituted quantities	Institutions	Provisions	IBC Institutions	IBC Provisions	UN No.	Properties and Observations
1052	HYDROGEN FLUORIDE, ANHYDROUS	8	6.1	1	-	0	EO	P200	-	-	-	-	1052	Category D. Clear of living quarters. Colourless, fuming and highly volatile liquid with an irritating and pungent odour. Highly corrosive to metals and glass in the presence of moisture. Boiling point: 20°C. Toxic if swallowed, by skin contact or by inhalation. Causes severe burns to skin, eyes and mucous membranes.
1053	HYDROGEN SULPHIDE	2.3	2.1	-	-	0	EO	P200	-	-	-	-	1053	Category D. Clear of living quarters. Liquefied, flammable, toxic gas with a foul odour. Heavier than air (1.2).
1055	ISOBUTYLENE	2.1	-	-	-	0	EO	P200	-	-	-	-	1055	Flammable hydrocarbon gas. Explosive limits: 1.8% to 8.8%. May contain propane, cyclopropane, propylene, butane, butylenes, etc., in varying proportions. Heavier than air (1.94).
1056	KRYPTON, COMPRESSED	2.2	-	-	-	120 ml	E1	P200	-	-	-	-	1056	Inert gas. Much heavier than air (2.9).
1057	LIGHTERS OR LIGHTER REFILLS containing flammable gas	2.1	-	-	201	0	EO	P002	P84	-	-	-	1057	Lighters or lighter refills containing butane or other flammable gas.
1058	LIQUEFIED GASES non-flammable, charged with nitrogen, carbon dioxide or air	2.2	-	-	-	120 ml	E1	P200	-	-	-	-	1058	Non-flammable gases or mixtures of such gases which are used for filling receptacles from which the contents are to be dispersed under pressure. Vapour may be heavier than air.
1060	METHYLACETYLENE AND PROPADIENE MIXTURE STABILIZED	2.1	-	-	-	0	EO	P200	-	-	-	-	1060	Flammable gas. Explosive limits: 3% to 11%. Heavier than air (1.4).
1061	METHYLAMINE, ANHYDROUS	2.1	-	-	-	0	EO	P200	-	-	-	-	1061	Liquefied, flammable gas with an ammonia-like odour. Heavier than air (1.09).
1062	METHYL BROMIDE with not more than 2.0% chloroacrin	2.3	-	-	23	0	EO	P200	-	-	-	-	1062	Liquefied, toxic gas with a chloroform-like odour. Much heavier than air (3.3). Boiling point: 4.5°C. Even though this substance has a flammability hazard, it only exhibits such hazard under extreme fire conditions in confined areas.
1063	METHYL CHLORIDE (REFRIGERANT GAS R 40)	2.1	-	-	-	0	EO	P200	-	-	-	-	1063	Liquefied, flammable gas. Explosive limits: 8% to 20%. Heavier than air (1.3).
1064	METHYL MERCAPTAN	2.3	2.1	-	-	0	EO	P200	-	-	-	-	1064	Liquefied, flammable, toxic gas with a foul odour. Heavier than air (1.7). Boiling point: 6°C.
1065	NEON, COMPRESSED	2.2	-	-	-	120 ml	E1	P200	-	-	-	-	1065	Inert gas. Lighter than air (0.7).
1066	NITROGEN, COMPRESSED	2.2	-	-	-	120 ml	E1	P200	-	-	-	-	1066	Non-flammable, odourless gas. Lighter than air (0.97).
1067	DNITROGEN TETROXIDE (NITROGEN DIOXIDE)	2.3	5.1/8	-	-	0	EO	P200	-	-	-	-	1067	Liquefied, non-flammable, toxic and corrosive gas which gives off brown vapour with a pungent odour. Strong oxidizing agent. Corrosive in the presence of water. Heavier than air (1.6). Boiling point: 21°C. Highly irritating to skin, eyes and mucous membranes. Toxic by inhalation, with delayed effects similar to phosgene.
1069	NITROSYL CHLORIDE	2.3	8	-	-	0	EO	P200	-	-	-	-	1069	Non-flammable, toxic yellow gas with an irritating odour. Corrosive to steel. Much heavier than air (2.3). Highly irritating to skin, eyes and mucous membranes.
1070	NITROUS OXIDE	2.2	5.1	-	-	0	EO	P200	-	-	-	-	1070	Non-flammable gas. Strong oxidizing agent. Heavier than air (1.5).

**TSFS 2015:66**  
**Bilaga 1**

UN No. (1)	PSN (2)	Class No. (3)	Subsidiary Risk(s) (4)	Packing Group (5)	Special Provisions (6)	Limited quantities (7a)	Excepted quantities (7b)	Packing		IBC		Portable tanks and bulk containers		EMS (15)	Stowage and Segregation (16)	Properties and Observations (17)	UN No. (18)	
								Class or Div. (5)	Subsidiary Risk(s) (4)	Institu-tions (10)	Provisions (11)	Tank instructions (14)	Provisions (14)					
	3.1.2	2.0	2.0	2.0, 1.3	3.3	3.4	3.5	4.1, 4	4.1, 4	4.1, 4	4.1, 4	4.2, 5	4.2, 5	54, 5.2	7.1 to 7.7			
1071	OIL GAS, COMPRESSED	2.3	2.1	-	-	0	EO	P200	-	-	-	-	-	F-D, S-U	Category D. Clear of living quarters. Flammable, toxic gas. A mixture of hydrocarbons and carbon monoxide.	Mixtures of liquid oxygen with acetylene or oils may explode.	1071	
1072	OXYGEN, COMPRESSED	2.2	5.1	-	355	0	EO	P200	-	-	-	-	-	F-C, S-W	Category A.	Non-flammable, odourless gas. Strong oxidizing agent. Heavier than air (1.1).	1072	
1073	OXYGEN, REFRIGERATED LIQUID	2.2	5.1	-	-	0	EO	P203	-	-	-	T75	T75	F-C, S-W	Category D.	Liquefied, non-flammable gas. Strong oxidizing agent. Mixtures of liquid oxygen with acetylene or oils may explode.	1073	
1075	PETROLEUM GASES, LIQUEFIED	2.1	-	-	-	0	EO	P200	-	-	-	T50	T50	F-D, S-U	Category E. Clear of living quarters.	Flammable hydrocarbon gases or mixtures obtained from natural gas or by distillation of mineral oils or coal, etc. May contain propane, cyclopropane, propylene, butane, butylene, etc., in varying proportions. Heavier than air.	1075	
1076	PHOSGENE	2.3	8	-	-	0	EO	P200	-	-	-	-	-	F-C, S-U	Category D. Clear of living quarters.	Liquefied, non-flammable, toxic and corrosive gas with a foul odour. Corrosive in the presence of water. Much heavier than air (3.5). Boiling point: 8°C. Highly irritating to skin, eyes and mucous membranes. This gas is extremely toxic and may cause severe damage and death after a few hours' delay.	1076	
1077	PROPYLENE	2.1	-	-	-	0	EO	P200	-	-	-	T50	T50	F-D, S-U	Category E. Clear of living quarters.	Flammable hydrocarbon gas. Explosive limits: 2% to 11.1%. Heavier than air (1.5).	1077	
1078	REFRIGERANT GAS, N.O.S.	2.2	-	-	274	120 ml	E1	P200	-	-	-	T50	T50	F-C, S-V	Category A.	Different chlorofluorohydrocarbons or other non-flammable, non-toxic gases considered as refrigerant agents.	1078	
1079	SULPHUR DIOXIDE	2.3	8	-	-	0	EO	P200	-	-	-	T50	TP19	F-C, S-U	Category D. Clear of living quarters.	Non-flammable, toxic and corrosive gas with a pungent odour. Much heavier than air (2.3). Highly irritating to skin, eyes and mucous membranes.	1079	
1080	SULPHUR HEXAFLUORIDE	2.2	-	-	-	120 ml	E1	P200	-	-	-	-	-	F-C, S-V	Category A.	Liquefied, non-flammable, odourless gas. Much heavier than air (5.1).	1080	
1081	TETRAFLUOROETHYLENE, STABILIZED	2.1	-	-	-	0	EO	P200	-	-	-	-	-	F-D, S-U	Category E. Clear of living quarters.	Liquefied, flammable gas. Explosive limits: 11% to 60%. Much heavier than air (5.5). Irritating to skin, eyes and mucous membranes.	1081	
1082	TRIFLUOROCHLOROETHYLENE, STABILIZED	2.3	2.1	-	-	0	EO	P200	-	-	-	T50	T50	F-D, S-U	Category D. Clear of living quarters.	Flammable, toxic, odourless gas. Explosive limits: 8.4% to 38.7%. Much heavier than air (4.0).	1082	
1083	TRIMETHYLAMINE, ANHYDROUS	2.1	-	-	-	0	EO	P200	-	-	-	T50	T50	F-D, S-U	Category B. Clear of living quarters.	Liquefied, flammable gas with a fishy odour. Explosive limits: 2% to 12%. Much heavier than air (2.1). Boiling point: 3°C.	1083	
1085	VINYL BROMIDE, STABILIZED	2.1	-	-	-	0	EO	P200	-	-	-	T50	T50	F-D, S-U	Category B. Clear of living quarters.	Liquefied, flammable gas. Much heavier than air (3.7). Boiling point: 16°C.	1085	
1086	VINYL CHLORIDE, STABILIZED	2.1	-	-	-	0	EO	P200	-	-	-	T50	T50	F-D, S-U	Category B. Clear of living quarters.	Liquefied, flammable gas. Explosive limits: 4% to 31%. Much heavier than air (2.2).	1086	
1087	VINYLMETHYL ETHER, STABILIZED	2.1	-	-	-	0	EO	P200	-	-	-	T50	T50	F-D, S-U	Category B. Clear of living quarters.	Liquefied, flammable gas. Explosive limits: 2.6% to 39%. Heavier than air (2.0). Boiling point: 0°C.	1087	
1088	ACETAL	3	-	II	-	1 l	E2	P001	-	IBC02	-	T4	TP1	F-E, S-D	Category E.	Colourless, volatile liquid with an agreeable odour. Flashpoint: below -18°C.c. Explosive limits: 1.6% to 10.4%. Miscible with water.	1088	
1089	ACETALDEHYDE	3	-	I	-	0	E3	P001	-	-	-	T11	TP2 TP7	F-E, S-D	Category E.	Colourless liquid with a pungent, fruity odour. Flashpoint: -27°C.c. Explosive limits: 4% to 52%. Boiling point: 20.2°C. Miscible with water. Harmful if swallowed or by inhalation.	1089	

UN No. (1)	PSN (2)	Class or Div. No. (3)	Subsidiary Risk(s) (4)	Packing Group (5)	Special Provisions (6)	Limited quantities (7a)	Excepted quantities (7b)	Packing		IBC		Portable tanks and bulk containers	EMs (15)	Storage and Segregation (16)	Properties and Observations (17)	UN No. (18)
								Instructi- ons (8)	Provisi- ons (9)	Instruc- tions (10)	Provisi- ons (11)					
1090	ACETONE	3	-	II	-	1 ℓ	E2	P001	-	IBC02	-	T4	F-E, S-D	Category E	Colourless, clear liquid, with a characteristic mini-like odour. Flashpoint: 20°C to -10°C c.c. Explosive limits: 2.5% to 13%. Miscible with water.	1090
1091	ACETONE OILS	3	-	II	-	1 ℓ	E2	P001	-	IBC02	-	T4	F-E, S-D	Category B	Light yellow to brownish, oily liquids. Flashpoint: -4°C to 8°C c.c. Immiscible with water.	1091
1092	AGROLEIN, STABILIZED	6.1	3	I	354	0	E0	P601	-	-	-	T22	F-E, S-D	Category D	Colourless or yellow liquid with a most irritating odour. Flashpoint: -26°C c.c. Explosive limits: 2.8% to 31%. Boiling point: 52°C. Miscible with water. Highly toxic if swallowed, by skin contact or by inhalation.	1092
1093	ACRYLONITRILE, STABILIZED	3	6.1	I	-	0	E0	P001	-	-	-	T14	F-E, S-D	Category E	Colourless, mobile liquid with a mild pungent odour. Flashpoint: -5°C c.c. Explosive limits: 3% to 17%. Partially miscible with water. Toxic if swallowed, by skin contact or by inhalation. Practice has shown that this substance may leak from packagings that ordinarily are leakproof to other chemicals.	1093
1098	ALLYL ALCOHOL	6.1	3	I	354	0	E0	P602	-	-	-	T20	F-E, S-D	Category D	Colourless liquid with a pungent mustard-like odour. Flashpoint: 21°C c.c. Explosive limits: 2.5% to 18%. Miscible with water. Highly toxic if swallowed, by skin contact or by inhalation.	1098
1099	ALLYL BROMIDE	3	6.1	I	-	0	E0	P001	-	-	-	T14	F-E, S-D	Category B	Colourless to light yellow liquid with an irritating odour. Flashpoint: 44°C. Boiling point: 44°C. Highly toxic if swallowed, by skin contact or by inhalation.	1099
1100	ALLYL CHLORIDE	3	6.1	I	-	0	E0	P001	-	-	-	T14	F-E, S-D	Category E	Colourless liquid with a unpleasant pungent odour. Flashpoint: -29°C c.c. Explosive limits: 3.3% to 11.1%. Boiling point: 44°C. Immiscible with water. Toxic if swallowed, by skin contact or by inhalation.	1100
1104	AMYL ACETATES	3	-	III	-	5 ℓ	E1	P001 LP01	-	IBC03	-	T2	F-E, S-D	Category A	Colourless liquids with a pear- or banana-like odour. normal-AMYL ACETATE: flashpoint 25°C c.c. secondary-AMYL ACETATE: flashpoint 32°C c.c. Immiscible with water.	1104
1105	PENTANOLS	3	-	II	-	1 ℓ	E2	P001	-	IBC02	-	T4	F-E, S-D	Category B	Colourless liquids with a strong odour. Immiscible with water. tertiary-AMYL ALCOHOL: flashpoint 19°C to 21°C c.c.	1105
1105	PENTANOLS	3	-	III	223	5 ℓ	E1	P001 LP01	-	IBC03	-	T2	F-E, S-D	Category A	See entry above. Explosive limits: 1.2% to 10.5%.	1105
1106	AMYLAMINE	3	8	II	-	1 ℓ	E2	P001	-	IBC02	-	T7	F-E, S-C	Category B	Colourless, clear liquids. Explosive limits: 2.2% to 22%. normal-AMYLAMINE (1-PENTYLAMINE): flashpoint 4°C c.c. tertiary-AMYLAMINE (3-PENTYLAMINE): flashpoint 2°C c.c. Miscible with water. Harmful by inhalation. Causes burns to skin, eyes and mucous membranes.	1106
1106	AMYLAMINE	3	8	III	223	5 ℓ	E1	P001	-	IBC03	-	T4	F-E, S-C	Category A	See entry above. However, irritating to skin, eyes and mucous membranes.	1106
1107	AMYL CHLORIDE	3	-	II	-	1 ℓ	E2	P001	-	IBC02	-	T4	F-E, S-D	Category B	Colourless or light brown liquids with an aromatic odour. n-AMYLCHLORIDE: flashpoint: 11°C. Explosive limits: normal-AMYL CHLORIDE [1.4% to 8.6%]: immiscible with water.	1107
1108	1-PENTENE (n-AMYLENE)	3	-	I	-	0	E3	P001	-	-	-	T11	F-E, S-D	Category E	Colourless, volatile liquid with a disagreeable odour. Flashpoint: -20°C c.c. Boiling point: 36°C. Immiscible with water. Irritating to skin, eyes and mucous membranes. Narcotic in high concentrations.	1108
1109	AMYL FORMATES	3	-	III	-	5 ℓ	E1	P001 LP01	-	IBC03	-	T2	F-E, S-D	Category A	Colourless liquids with a pleasant odour. normal-AMYL FORMATE: flashpoint 27°C c.c. ISOAMYL FORMATE: flashpoint 26°C c.c. Explosive limits: 1.7% to 10%. Immiscible with water.	1109

**TSFS 2015:66**  
**Bilaga 1**

UN No. (1)	PSN (2)	Class or Div (3)	Subsidiary Risk(s) (4)	Packing Group (5)	Special Provisions (6)	Limited quantities (7a)	Excepted quantities (7b)	Packing		IBC		Portable tanks and bulk containers		EMs (15)	Stowage and Segregation (16)	Properties and Observations (17)	UN No. (18)
								Institutions (8)	Provisions (9)	Institutions (10)	Provisions (11)	Tank instructions (12)	Provisions (13)				
1110	n-AMYL METHYL KETONE	3	-	III	-	5 ℓ	E1	P001 LPO1	-	IBC03	-	T2	TP1	F-E, S-D	Category A	Colourless liquid. Flashpoint: 49°C c.c. Immiscible with water.	1110
1111	AMYL MERCAPTAN	3	-	II	-	1 ℓ	E2	P001	-	IBC02	-	T4	TP1	F-E, S-D	Category B	Colourless to yellow liquids with an extremely disagreeable garlic-like odour. normal-AMYL MERCAPTAN: flashpoint 7°C c.c. normal-AMYL MERCAPTAN: flashpoint 19°C c.c. ISOAMYL MERCAPTAN: flashpoint 18°C c.c. Immiscible with water. These substances may leak from packagings that ordinarily are leakproof to other chemicals.	1111
1112	AMYL NITRATE	3	-	III	-	5 ℓ	E1	P001 LPO1	-	IBC03	-	T2	TP1	F-E, S-D	Category A	Colourless liquids with an ether-like odour normal - AMYL NITRATE: flashpoint 17°C c.c. ISOAMYL NITRATE: flashpoint 32°C c.c. Immiscible with water. Harmful by inhalation.	1112
1113	AMYL NITRITE	3	-	II	-	1 ℓ	E2	P001	-	IBC02	-	T4	TP1	F-E, S-D	Category E	Clear of living quarters. Yellowish, transparent, volatile liquid with a fragrant fruity odour. Flashpoint: 10°C c.c. normal-AMYL NITRITE: 10°C c.c. Flashpoint of pure normal -AMYL NITRITE: 10°C c.c. Decomposes on exposure to air, light or water, evolving toxic nitrous fumes which are orange in colour. Immiscible with water. Harmful by inhalation.	1113
1114	BENZENE	3	-	II	-	1 ℓ	E2	P001	-	IBC02	-	T4	TP1	F-E, S-D	Category B	Colourless liquid with a characteristic odour. Flashpoint: -11°C c.c. Explosive limits: 1.4% to 8%. Freezing point 5°C, rises below its freezing point to -95°C. Immiscible with water. This substance may produce serious chronic effects of a toxic nature.	1114
1120	BUTANOLS	3	-	II	-	1 ℓ	E2	P001	-	IBC02	-	T4	TP1 TP29	F-E, S-D	Category B	Colourless liquids with a disagreeable odour. Explosive limits: normal - BUTANOL 1.4% to 1.2% secondary - BUTANOL 1.7% to 9.8% tertiary - BUTANOL 2.4% to 8%. normal - BUTANOL is immiscible with water. Primary - BUTANOL is miscible with water. tertiary - BUTANOL is miscible with water. Irritating to skin, eyes and mucous membranes.	1120
1120	BUTANOLS	3	-	III	223	5 ℓ	E1	P001 LPO1	-	IBC03	-	T2	TP1	F-E, S-D	Category A	See entry above.	1120
1123	BUTYLACETATES	3	-	II	-	1 ℓ	E2	P001	-	IBC02	-	T4	TP1	F-E, S-D	Category B	Colourless liquids with a pineapple-like odour. Immiscible with water. normal - BUTYL ACETATE: flashpoint 27°C c.c. Explosive limits: 1.5% to 15%.	1123
1123	BUTYLACETATES	3	-	III	223	5 ℓ	E1	P001 LPO1	-	IBC03	-	T2	TP1	F-E, S-D	Category A	See entry above.	1123
1125	n-BUTYLAMINE	3	8	II	-	1 ℓ	E2	P001	-	IBC02	-	T7	TP1	F-E, S-C	Category B	Flashpoint -9°C c.c. Explosive limits 1.7% to 10%. Colourless, volatile liquid with an ammonia-like odour. Miscible with water. Causes burns to skin, eyes and mucous membranes.	1125
1126	1-BROMOBUTANE	3	-	II	-	1 ℓ	E2	P001	-	IBC02	-	T4	TP1	F-E, S-D	Category B	Colourless to pale straw-coloured, clear liquid. Flashpoint: 13°C c.c. Explosive limits: 2.6% to 6.6%. Immiscible with water. Narcotic.	1126
1127	CHLOROBUTANES	3	-	II	-	1 ℓ	E2	P001	-	IBC02	-	T4	TP1	F-E, S-D	Category B	Colourless liquids. tertiary-BUTYL CHLORIDE: flashpoint -30°C c.c., boiling point 51°C. Immiscible with water.	1127
1128	n-BUTYL FORMATE	3	-	II	-	1 ℓ	E2	P001	-	IBC02	-	T4	TP1	F-E, S-D	Category B	Colourless liquid. Flashpoint: 18°C c.c. Explosive limits: 1.6% to 8.3%. Immiscible with water.	1128
1129	BUTYLBALDEHYDE	3	-	II	-	1 ℓ	E2	P001	-	IBC02	-	T4	TP1	F-E, S-D	Category B	Colourless liquid with a characteristic pungent odour. Flashpoint: -7°C c.c. Explosive limits: 1.4% to 12.5%. Immiscible with water.	1129
1130	CAMPHOR OIL	3	-	III	-	5 ℓ	E1	P001 LPO1	-	IBC03	-	T2	TP1	F-E, S-E	Category A	Colourless oil with a characteristic odour. Flash point: 47°C c.c. Immiscible with water.	1130





**TSFS 2015:66  
Bilaga 1**

UN No. (1)	PSN (2)	Class or Div (3)	Subsidiary Risk(s) (4)	Packing Group (5)	Special Provisions (6)	Limited quantities (7a)	Excepted quantities (7b)	Packing			IBC		Portable tanks and bulk containers	EMs (15)	Stowage and Segregation (16)	Properties and Observations (17)	UN No. (18)
								Class (8)	Packing (9)	Instruc-tions (10)	Provisions (11)	Tank instructions (12)					
	3.1.2	2.0	2.0	2.0, 1.3	3.3	3.4	3.5	4.1, 4	4.1, 4	4.1, 4			4.2, 5 4.3	5.4, 5.2 7.8	7.1 to 7.7		
1146	CYCLOPENTANE	3	-	II	-	1 ℓ	E2	P001	-	IBC02	-	T7	TP1	F-E, S-D	Category E	Colourless liquid with a pungent odour. Flashpoint: below -18°C c.c. Boiling point: 49°C. Immiscible with water. Irritating to skin, eyes and mucous membranes. Narcotic in high concentrations.	1146
1147	DECAHYDRONAPHTHALENE	3	-	III	-	5 ℓ	E1	P001 LP01	-	IBC03	-	T2	TP1	F-E, S-D	Category A	Colourless liquids with an aromatic odour. Flashpoint: 52°C to 57°C c.c. Explosive limits: 0.7% to 4.9%. Immiscible with water. Harmful by inhalation.	1147
1148	DIACETONE ALCOHOL	3	-	II	-	1 ℓ	E2	P001	-	IBC02	-	T4	TP1	F-E, S-D	Category B	Colourless liquid. Explosive limits: 1.4% to 8%. Miscible with water.	1148
1148	DIACETONE ALCOHOL	3	-	III	223	5 ℓ	E1	P001 LP01	-	IBC03	-	T2	TP1	F-E, S-D	Category A	See entry above.	1148
1149	DI-BUTYL ETHERS	3	-	III	-	5 ℓ	E1	P001	-	IBC03	-	T2	TP1	F-E, S-D	Category A	Colourless liquids with a mild ether-like odour. Explosive limits: 0.9% to 8.5%. Immiscible with water. Flashpoint: 25°C c.c. normal - DI-BUTYL ETHER.	1149
1150	1,2-DICHLOROETHYLENE	3	-	II	-	1 ℓ	E2	P001	-	IBC02	-	T7	TP2	F-E, S-D	Category B	Colourless liquid with a chloroform-like odour. Flashpoint: 6°C c.c. Explosive limits: 5.6% to 16%. Immiscible with water. Boiling range: 48°C to 61°C.	1150
1152	DICHLOROPENTANES	3	-	III	-	5 ℓ	E1	P001 LP01	-	IBC03	-	T2	TP1	F-E, S-D	Category A	Light yellow liquids. 1,5-DICHLOROPENTANE: flashpoint 26°C c.c. Immiscible with water.	1152
1153	ETHYLENE GLYCOLDIETHYL ETHER	3	-	II	-	1 ℓ	E2	P001	-	IBC02	-	T4	TP1	F-E, S-D	Category A	Colourless liquid with an ether-like odour. Flashpoint: 35°C c.c. Immiscible with water.	1153
1153	ETHYLENE GLYCOLDIETHYL ETHER	3	-	III	-	5 ℓ	E1	P001 LP01	-	IBC03	-	T2	TP1	F-E, S-D	Category A	See entry above.	1153
1154	DIETHYLAMINE	3	8	II	-	1 ℓ	E2	P001	-	IBC02	-	T7	TP1	F-E, S-C	Category E. Clear of living quarters.	Colourless liquid with an ammonia-like odour. Flashpoint: -39°C c.c. Boiling point: 6°C. Immiscible with water. Causes burns to skin, eyes and mucous membranes. Harmful if swallowed. Causes dangerous lung irritation.	1154
1155	DIETHYLETHER (ETHYL ETHER)	3	-	I	-	0	E3	P001	-	-	-	T11	TP2	F-E, S-D	Category E. Clear of living quarters.	Colourless, volatile and mobile liquid with a pleasant aromatic odour. Flashpoint: -40°C c.c. Explosive limits: 1.7% to 48%. Boiling point: 34°C. Immiscible with water. In the presence of oxygen or on long standing, it may form peroxides. These peroxides may form, these may explode spontaneously or when heated. Strongly narcotic. Readily ignited by static electricity.	1155
1156	DIETHYL KETONE	3	-	II	-	1 ℓ	E2	P001	-	IBC02	-	T4	TP1	F-E, S-D	Category B	Colourless, mobile liquid. Flashpoint: 13°C c.c. Explosive limits: 1.6% to... Immiscible with water.	1156
1157	DISOBUTYL KETONE	3	-	III	-	5 ℓ	E1	P001 LP01	-	IBC03	-	T2	TP1	F-E, S-D	Category A	Colourless liquid. Flashpoint: 49°C c.c. Explosive limits: 0.8% to 7.1%. Immiscible with water.	1157
1158	DISOPROPYLAMINE	3	8	II	-	1 ℓ	E2	P001	-	IBC02	-	T7	TP1	F-E, S-C	Category B	Colourless, volatile liquid with a fishy odour. Flashpoint: -7°C c.c. Boiling point: 35°C. Immiscible with water. Harmful by inhalation. Causes burns to skin, eyes and mucous membranes.	1158
1159	DISOPROPYL ETHER	3	-	II	-	1 ℓ	E2	P001	-	IBC02	-	T4	TP1	F-E, S-D	Category E. Clear of living quarters.	Colourless liquid with an ether-like odour. Flashpoint: 29°C c.c. Explosive limits: 1.1% to 21%. Immiscible with water. In the presence of oxygen or on long standing or exposure to sunlight, unstable peroxides may form. These may explode spontaneously or when heated. Strongly narcotic. Readily ignited by static electricity.	1159

UN No. (1)	PSN (2)	Class or Div (3)	Subsidiary Risk(s) (4)	Packing Group (5)	Special Provisions (6)	Limited quantities (7a)	Excepted quantities (7b)	Packing			IBC		Properties and Observations (17)
								Instruc-tions (8)	Provisions (9)	Instruc-tions (10)	Provisions (11)		
	3.1.2	2.0	2.0	2.0	3.3	3.4	3.5	4.1.4	4.1.4	4.1.4	4.1.4		
1160	DIMETHYLAMINE, AQUEOUS SOLUTION	3	8	II	-	1 ℓ	E2	P001	-	IBC02	-		Aqueous solution of a flammable gas, with an ammonia-like odour. Flashpoint: 14.4°C. Boiling point for 60% solution in water: 36°C. Flashpoint for 25% solution in water: 0°C c.c. Miscible with water. Harmful by inhalation. Causes burns to skin, eyes and mucous membranes. Reacts violently with acid.
1161	DIMETHYL CARBONATE	3	-	II	-	1 ℓ	E2	P001	-	IBC02	-		Colourless liquid. Immiscible with water. Flashpoint: 18°C c.c.
1162	DIMETHYLCHLOROSILANE	3	8	II	-	0	E0	P010	-	-	-		Colourless liquid with a pungent odour. Flashpoint: -9°C c.c. Explosive limits: 1.4% to 9.5%. Immiscible with water. Reacts with water to form a complex mixture of dimethylsiloxanes and evolves hydrogen chloride, a toxic and corrosive gas. Harmful by inhalation. Causes burns to skin, eyes and mucous membranes.
1163	DIMETHYLHYDRAZINE, UNSYMMETRICAL	6.1	3/8 P	I	354	0	E0	P602	-	-	-		Colourless liquid with an ammonia-like odour. Flashpoint: -18°C c.c. Explosive limits: 2% to 95%. Miscible with water, generating heat. Reacts violently with acids. Highly flammable by inhalation, by ingestion and by contact with skin. Causes burns to skin, eyes and mucous membranes. May react dangerously with oxidizing substances.
1164	DIMETHYL SULPHIDE	3	-	II	-	1 ℓ	E2	P001	-	IBC02	B8		Colourless liquid with a disagreeable odour. Flashpoint: -37°C c.c. Explosive limits: 2.2% to 19.7%. Boiling point: 37°C. Immiscible with water. When involved in a fire, evolves toxic gases. Narcotic in high concentrations.
1165	DIOXANE	3	-	II	-	1 ℓ	E2	P001	-	IBC02	-		Colourless liquid with an ether-like odour. Flashpoint: 12°C c.c. Explosive limits: 2% to 22%. Miscible with water. Harmful by inhalation.
1166	DIOXOLANE	3	-	II	-	1 ℓ	E2	P001	-	IBC02	-		Colourless liquid. Flashpoint: 2°C c.c. Miscible with water. Harmful by inhalation.
1167	DIVINYL ETHER, STABILIZED	3	-	I	-	0	E3	P001	-	-	-		Colourless, clear liquid with a characteristic odour. Flashpoint: -30°C c.c. Boiling point: 35°C. Miscible with water. Reacts with oxygen in the presence of oxygen or on long standing or exposure to sunlight, unstable peroxides sometimes form; these may explode spontaneously or when heated. Strongly narcotic. Readily ignited by static electricity.
1169	EXTRACTS, AROMATIC, LIQUID	3	-	II	-	5 ℓ	E2	P001	-	IBC02	-		Usually consist of alcoholic solutions. Miscibility with water depends upon the composition.
1169	EXTRACTS, AROMATIC, LIQUID	3	-	III	223 955	5 ℓ	E1	P001 LP01	-	IBC03	-		See entry above.
1170	ETHANOL (ETHYL ALCOHOL) or ETHANOL SOLUTION (ETHYL ALCOHOL SOLUTION)	3	-	II	144	1 ℓ	E2	P001	-	IBC02	-		Colourless, volatile liquids. Pure ETHANOL: flashpoint 13°C c.c. Explosive limits: 3.3% to 19%. Miscible with water.
1170	ETHANOL (ETHYL ALCOHOL) or ETHANOL SOLUTION (ETHYL ALCOHOL SOLUTION)	3	-	III	144 223	5 ℓ	E1	P001 LP01	-	IBC03	-		See entry above.
1171	ETHYLENE GLYCOL MONOETHYL ETHER	3	-	III	-	5 ℓ	E1	P001 LP01	-	IBC03	-		Colourless liquid. Flashpoint: 40°C c.c. Explosive limits: 1.7% to 15.6%. Miscible with water.
1172	ETHYLENE GLYCOL MONOETHYL ETHER ACETATE	3	-	III	-	5 ℓ	E1	P001 LP01	-	IBC03	-		Colourless liquid. Flashpoint: 51°C c.c. Explosive limits: 1.7% to 10.1%. Partially miscible with water.
1173	ETHYL ACETATE	3	-	II	-	1 ℓ	E2	P001	-	IBC02	-		Colourless liquid with a fragrant odour. Flashpoint: -4°C c.c. Explosive limits: 2.18% to 11.5%. Immiscible with water.

**TSFS 2015:66**  
**Bilaga 1**

UN No. (1)	PSN (2)	Class No. (3)	Subsidiary Risk(s) (4)	Packing Group (5)	Special Provisions (6)	Limited quantities (7a)	Excepted quantities (7b)	Packing		IBC		Portable tanks and bulk containers	EMs (15)	Stowage and Segregation (16)	Properties and Observations (17)	UN No. (18)		
								Instruc-tions (8)	Provisions (9)	Instruc-tions (10)	Provisions (11)						Tank instructions (12)	Provisions (13)
3	3.1.2	2.0	2.0	2.0	3.3	3.4	3.5	4.1,4	4.1,4	4.1,4	4.1,4	T4	TP1	F-E, S-D	Category B	Colourless liquid with an aromatic odour. Flashpoint: 27°C c.c. Explosive limits: 1% to 6.7%. Immiscible with water.	1175	
1175	ETHYLBENZENE	3	-	II	-	1 ℓ	E2	P001	-	IBC02	-	T4	TP1	F-E, S-D	Category B	Colourless liquid with an aromatic odour. Flashpoint: 27°C c.c. Explosive limits: 1% to 6.7%. Immiscible with water.	1175	
1176	ETHYLBORATE	3	-	II	-	1 ℓ	E2	P001	-	IBC02	-	T4	TP1	F-E, S-D	Category B	Colourless liquid. Flashpoint: 11°C c.c. Immiscible with water.	1176	
1177	2-ETHYLBUTYL ACETATE	3	-	III	-	5 ℓ	E1	P001	-	IBC03	-	T2	TP1	F-E, S-D	Category A	Colourless liquid. Flashpoint: 54°C c.c. Immiscible with water.	1177	
1178	2-ETHYLBUTYALDEHYDE	3	-	II	-	1 ℓ	E2	P001	-	IBC02	-	T4	TP1	F-E, S-D	Category B	Colourless liquid. Flashpoint: 11°C c.c. Explosive limits: 1.2% to 7.7%. Immiscible with water.	1178	
1179	ETHYL BUTYL ETHER	3	-	II	-	1 ℓ	E2	P001	-	IBC02	-	T4	TP1	F-E, S-D	Category B	Colourless liquid. Flashpoint: -1°C c.c. Immiscible with water.	1179	
1180	ETHYL BUTYRATE	3	-	III	-	5 ℓ	E1	P001	-	IBC03	-	T2	TP1	F-E, S-D	Category A	Colourless, volatile liquid with a pineapple-like odour. Flashpoint: 26°C c.c. Immiscible with water.	1180	
1181	ETHYL CHLOROACETATE	6.1	3	II	-	100 ml	E4	P001	-	IBC02	-	T7	TP2	F-E, S-D	Category A	Colourless, flammable liquid with a pungent and fruity odour. Flashpoint: 54°C c.c. Immiscible with water. When heated, evolves toxic and corrosive fumes. Toxic if swallowed, by skin contact or by inhalation.	1181	
1182	ETHYLCHLOROFORMATE	6.1	3/8	I	354	0	E0	P602	-	-	-	T20	TP2 TP3 TP37	F-E, S-C	Category D. Clear of living quarters. Segregation as for class 3 but "Away from class 4.1."	Colourless liquid. Flashpoint: 16°C c.c. Reacts and decomposes with water or heat, evolving hydrogen chloride, an irritating and corrosive gas. Highly toxic if swallowed, by skin contact or by inhalation. Causes burns to skin, eyes and mucous membranes.	1182	
1183	ETHYLDICHLOROSILANE	4.3	3/8	I	-	0	E0	P401	PP31	-	-	T14	TP2 TP3	F-C, S-O	Category D. Clear of living quarters. Segregation as for class 3 but "Away from" classes 3, 4, 1 and 8.	Colourless, very volatile liquid with a pungent odour. Flashpoint: -1°C c.c. Immiscible with water. Reacts violently with water or steam to produce heat which may lead to self-ignition; toxic and corrosive fumes will be evolved. May react vigorously in contact with oxidizing substances. Causes burns to skin, eyes and mucous membranes.	1183	
1184	ETHYLENE DICHLORIDE	3	6.1	II	-	1 ℓ	E2	P001	-	IBC02	-	T7	TP1	F-E, S-D	Category B	Clear of living quarters.	Colourless liquid with a chloroform-like odour. Flashpoint: 13°C c.c. Explosive limits: 6.2% to 15.9%. Immiscible with water. Toxic by inhalation. Irritating to skin, eyes and mucous membranes.	1184
1185	ETHYLENEMINE, STABILIZED	6.1	3	I	354	0	E0	P601	-	-	-	T22	TP2 TP13	F-E, S-D	Category D. Clear of living quarters.	Colourless, only flammable liquid with a pungent ammonia-like odour. Flashpoint: 20°C c.c. Immiscible with water. Highly toxic if swallowed, by skin contact or by inhalation.	1185	
1188	ETHYLENE GLYCOL MONOMETHYL ETHER	3	-	III	-	5 ℓ	E1	P001	-	IBC03	-	T2	TP1	F-E, S-D	Category A	Miscible with water.	Colourless liquid. Flashpoint: 38°C c.c. Explosive limits: 1.8% to 20%. Immiscible with water.	1188
1189	ETHYLENE GLYCOL MONOMETHYL ETHER ACETATE	3	-	III	-	5 ℓ	E1	P001	-	IBC03	-	T2	TP1	F-E, S-D	Category A	Explosive limits: 1.7% to 8.2%. Miscible with water.	Colourless liquid with a characteristic odour. Flashpoint: 44°C c.c. Explosive limits: 1.7% to 8.2%. Miscible with water.	1189
1190	ETHYL FORMATE	3	-	II	-	1 ℓ	E2	P001	-	IBC02	-	T4	TP1	F-E, S-D	Category E	Colourless liquid with a pleasant aromatic odour. Flashpoint: -20°C c.c. Explosive limits: 3.5% to 16.5%. Boiling point: 54°C. Immiscible with water.	1190	
1191	OCTYL ALDRHYDES	3	-	III	-	5 ℓ	E1	P001	-	IBC03	-	T2	TP1	F-E, S-D	Category A	Colourless liquids with a characteristic odour. Flashpoint: 48°C to 32°C c.c. Explosive limits: 0.3% to 7.2%. Immiscible with water.	1191	
1192	ETHYL LACTATE	3	-	III	-	5 ℓ	E1	P001	-	IBC03	-	T2	TP1	F-E, S-D	Category A	Explosive limits: 1.5% to 11.4%. Miscible with water.	Colourless liquid. Flashpoint: 46°C c.c. Explosive limits: 1.5% to 11.4%. Miscible with water.	1192

UN No. (1)	PSN (2)	Class or Div (5)	Subsidiary Risk(s) (4)	Packing Group (3)	Special Provisions (6)	Limited quantities (7a)	Excepted quantities (7b)	Packing		IBC		Portable tanks and bulk containers		EMs (15)	Stowage and Segregation (16)	Properties and Observations (17)	UN No. (18)	
								Instruc-tions (8)	Provisions (9)	Instruc-tions (10)	Provisions (11)	Tank instructions (13)	Provisions (14)					
	3.1.2	2.0	2.0	2.0	1.3	3.3	3.4	3.5	4.1, 4	4.1, 4	4.1, 4	4.3	4.2, 5	5.4, 5.2	7.8	7.1 to 7.7		
1193	ETHYL METHYL KETONE (METHYLETHYL KETONE)	3	-	II	-	1 ℓ	E2	P001	-	IBC02	-	T4	TP1	F-E, S-D	Category B.	Colourless liquid. Flashpoint: -1°C c.c. Explosive limits: 1.8% to 11.5%. Miscible with water.	1193	
1194	ETHYL NITRITE SOLUTION	3	6.1	I	900	0	EO	P001	-	-	-	-	-	F-E, S-D	Category D.	Clear of living quarters. Alcoholic solution of ethyl nitrite. Extremely volatile, with an aromatic, ethereal odour. Explosive limits of the pure product: 3% to 50%. Boiling point of pure product: 17°C. Miscible or partially miscible with water. ...	1194	
1195	ETHYL PROPIONATE	3	-	II	-	1 ℓ	E2	P001	-	IBC02	-	T4	TP1	F-E, S-D	Category B.	Colourless liquid with a pineapple-like odour. Flashpoint: 12°C c.c. Explosive limits: 1.8% to 11%. Immiscible with water.	1195	
1196	ETHYLTRICHLOROSUANE	3	8	II	-	0	EO	P010	-	-	-	T10	TP2 TP7 TP13	F-E, S-C	Category B.	Clear of living quarters. Colourless liquid with a pungent odour. Flashpoint: 14°C c.c. Readily hydrolysed by moisture, evolving hydrogen chloride, an irritating and corrosive gas apparent as white fumes. Causes burns to skin and eyes. Irritating to mucous membranes.	1196	
1197	EXTRACTS, FLAVOURING, LIQUID	3	-	II	-	5 ℓ	E2	P001	-	IBC02	-	T4	TP1 TP8	F-E, S-D	Category B.	Usually consist of alcoholic solutions. Miscibility with water depends upon the composition.	1197	
1197	EXTRACTS, FLAVOURING, LIQUID	3	-	III	223 955	5 ℓ	E1	P001 LP01	-	IBC03	-	T2	TP1	F-E, S-D	Category A.	See entry above.	1197	
1198	FORMALDEHYDE SOLUTION, FLAMMABLE	3	8	III	-	5 ℓ	E1	P001	-	IBC03	-	T4	TP1	F-E, S-C	Category A.	Clear of living quarters. Colourless liquids with a pungent odour. Flashpoint: 32-60°C c.c. Miscible with water. Irritating to skin, eyes and mucous membranes.	1198	
1199	FURALDEHYDES	6.1	3	II	-	100 ml <sup>f</sup>	E4	P001	-	IBC02	-	T7	TP2	F-E, S-D	Category A.	Colourless or reddish-brown, mobile liquid with a pungent odour. Miscible with water. Explosive limits for 2-FURALDEHYDE: 2.1% to 19.3%. Flashpoints: 2-FURALDEHYDE 60°C c.c., 3-FURALDEHYDE 48°C c.c. Toxic if swallowed, by skin contact or by inhalation.	1199	
1201	FUSEL OIL	3	-	II	-	1 ℓ	E2	P001	-	IBC02	-	T4	TP1	F-E, S-D	Category B.	Colourless, oily liquid with a disagreeable odour. A mixture consisting of amyl alcohols. Immiscible with water.	1201	
1201	FUSEL OIL	3	-	III	223 955	5 ℓ	E1	P001 LP01	-	IBC03	-	T2	TP1	F-E, S-D	Category A.	See entry above.	1201	
1202	GAS OIL or DIESEL FUEL or HEATING OIL, LIGHT	3	-	III	363	5 ℓ	E1	P001 LP01	-	IBC03	-	T2	TP1	F-E, S-E	Category A.	Immiscible with water.	1202	
1203	MOTOR SPIRIT or GASOLINE or PETROL	3	-	II	243 363	1 ℓ	E2	P001	-	IBC02	-	T4	TP1	F-E, S-E	Category E.	Immiscible with water.	1203	
1204	NITROGLYCERIN SOLUTION IN ALCOHOL with not more than 1% nitroglycerin	3	-	II	-	1 ℓ	EO	P001	PP5	IBC02	-	-	-	F-E, S-D	Category B.	Immiscible with water. Ignites readily. When involved in a fire, evolves large quantities of toxic and corrosive fumes. The contents of the package may allow solvent to evaporate and thus leave the nitroglycerin in an explosive state.	1204	
1206	HEPTANES	3	-	II	-	1 ℓ	E2	P001	-	IBC02	-	T4	TP1	F-E, S-D	Category B.	Colourless, volatile liquids. Explosive limits: 1.1%-6.7%. n-HEPTANE. Flashpoint -4°C c.c. Immiscible with water. Irritating to skin, eyes and mucous membranes.	1206	
1207	HEXALDEHYDE	3	-	III	-	5 ℓ	E1	P001 LP01	-	IBC03	-	T2	TP1	F-E, S-D	Category A.	Colourless liquid with a pungent odour. Flashpoint: 32°C c.c. Immiscible with water.	1207	

**TSFS 2015:66**  
**Bilaga 1**

UN No. (1)	PSN (2)	Class or Div (3)	Subsidiary Risk(s) (4)	Packing Group (5)	Special Provisions (6)	Limited quantities (7a)	Excepted quantities (7b)	Packing			IBC			Portable tanks and bulk containers	EMs (15)	Stowage and Segregation (16)	Properties and Observations (17)	UN No. (18)
								Class (8)	Packing (9)	Instruct-ions (10)	Instruc-tions (11)	Instruc-tions (12)	Instruc-tions (13)					
3.1.2		2.0	2.0	2.0, 1.3	3.3	3.4	3.5	4.1, 4	4.1, 4	4.1, 4				4.2, 5 4.3	5.4, 5.2 7.8	7.1 to 7.7		
1208	HEXANES	3	-	II	-	1 ℓ	E2	P001	-	IBC02	-		T4	TP1	F-E, S-D	Category E	Colourless, volatile liquids with a faint odour. Explosive limits: 1.1% to 7.7% in air. n-HEXANE: flashpoint-22°C c.c. boiling point 69°C. n-HEXANE: flashpoint-22°C c.c. boiling point 69°C. NIOHEXANE: flashpoint-48°C c.c. boiling point 50°C. Immiscible with water. Slightly irritating to skin, eyes and mucous membranes.	1208
1210	PRINTING INK flammable or PRINTING INK RELATED MATERIAL (including printing ink thinning or reducing compound), flammable	3	-	I	163	500 ml	E3	P001	-	-	-	-	T11	TP1 TP8	F-E, S-D	Category E	Fluid or viscous liquid containing colouring matter in solution or suspension. Immiscible with water. Slightly irritating to skin, eyes and mucous membranes. Miscibility with water depends upon the solvent.	1210
1210	PRINTING INK flammable or PRINTING INK RELATED MATERIAL (including printing ink thinning or reducing compound), flammable	3	-	II	163	5 ℓ	E2	P001	P01	IBC02	-		T4	TP1 TP8	F-E, S-D	Category B	See entry above.	1210
1210	PRINTING INK flammable or PRINTING INK RELATED MATERIAL (including printing ink thinning or reducing compound), flammable	3	-	III	163	5 ℓ	E1	P001 LP01	P01	IBC03	-		T2	TP1	F-E, S-D	Category A	See entry above.	1210
1212	ISOBUTANOL (ISOBUTYL ALCOHOL)	3	-	III	-	5 ℓ	E1	P001 LP01	-	IBC03	-		T2	TP1	F-E, S-D	Category A	Colourless liquid with a sweet odour. Flashpoint: 28°C c.c. Explosive limits: 1.2% to 10.9%. Partially miscible with water.	1212
1213	ISOBUTYL ACETATE	3	-	II	-	1 ℓ	E2	P001	-	IBC02	-		T4	TP1	F-E, S-D	Category B	Colourless liquid with a pleasant, like odour. Flashpoint: 18°C c.c. Explosive limits: 1.3% to 10.5%. Immiscible with water.	1213
1214	ISOBUTYLAMINE	3	8	II	-	1 ℓ	E2	P001	-	IBC02	-		T7	TP1	F-E, S-C	Category B	Clear of living quarters. Colourless liquid. Flashpoint: -9°C c.c. Explosive limits: 3.4% to 9%. Miscible with water. Harmful by inhalation. Causes burns to skin and eyes. Irritating to mucous membranes.	1214
1216	ISOCTENES	3	-	II	-	1 ℓ	E2	P001	-	IBC02	-		T4	TP1	F-E, S-D	Category B	Colourless liquids. Immiscible with water.	1216
1218	ISOPRENE, STABILIZED	3	-	I	-	0	E3	P001	-	-	-		T11	TP2	F-E, S-D	Category E	Colourless, volatile liquid. Flashpoint: -48°C c.c. Explosive limits: 1.5% to 9.7%. Boiling point: 34°C. Immiscible with water.	1218
1219	ISOPROPANOL (ISOPROPYL ALCOHOL)	3	-	II	-	1 ℓ	E2	P001	-	IBC02	-		T4	TP1	F-E, S-D	Category B	Colourless, mobile liquid. Flashpoint: 12°C c.c. Explosive limits: 2% to 12%. Miscible with water.	1219
1220	ISOPROPYL ACETATE	3	-	II	-	1 ℓ	E2	P001	-	IBC02	-		T4	TP1	F-E, S-D	Category B	Colourless liquid with an aromatic odour. Flashpoint: 11°C c.c. Explosive limits: 1.8% to 7.8%. Immiscible with water.	1220
1221	ISOPROPYLAMINE	3	8	I	-	0	E0	P001	-	-	-		T11	TP2	F-E, S-C	Category E	Clear of living quarters. Colourless, volatile liquid with an ammonia-like odour. Flashpoint: -37°C c.c. Explosive limits: 2.3% to 10.4%. Boiling point: 32°C. Miscible with water. Harmful if swallowed. Causes burns to skin, eyes and mucous membranes.	1221
1222	ISOPROPYL NITRATE	3	-	II	26	1 ℓ	E2	P001	-	-	-		-	-	F-E, S-D	Category D	Colourless liquid. Flashpoint: 12°C c.c. Explosive limits: up to 100%. Immiscible with water. May explode on heating. Harmful by inhalation.	1222
1223	KEROSENE	3	-	III	363	5 ℓ	E1	P001 LP01	-	IBC03	-		T2	TP2	F-E, S-E	Category A	Immiscible with water.	1223
1224	KETONES, LIQUID, N.O.S.	3	-	II	274	1 ℓ	E2	P001	-	IBC02	-		T7	TP1 TP8 TP28	F-E, S-D	Category B	-	1224
1224	KETONES, LIQUID, N.O.S.	3	-	III	223	5 ℓ	E1	P001 LP01	-	IBC03	-		T4	TP1 TP29	F-E, S-D	Category A	-	1224

UN No. (1)	PSN (2)	Class or Div (5)	Subsidiary Risk(s) (4)	Packing Group (3)	Special Provisions (6)	Limited quantities (7a)	Excepted quantities (7b)	Packing		IBC	
								Instruc-tions (8)	Provisions (9)	Instruc-tions (10)	Provisions (11)
3.1.2		2.0	2.0	2.0	1.3	3.3	3.4	4.1,4	4.1,4	4.1,4	4.1,4
1228	MERCAPTANS, LIQUID, FLAMMABLE; TOXIC, N.O.S. or MERCAPTAN MIXTURE, LIQUID, FLAMMABLE, TOXIC, N.O.S.	3	6.1	II	274	1 ℓ	E2	P001	-	IBC02	-
1228	MERCAPTANS, LIQUID, FLAMMABLE; TOXIC, N.O.S. or MERCAPTAN MIXTURE, LIQUID, FLAMMABLE, TOXIC, N.O.S.	3	6.1	III	223 274	5 ℓ	E1	P001	-	IBC03	-
1229	METHYL OXIDE	3	-	III	-	5 ℓ	E1	P001 LP01	-	IBC03	-
1230	METHANOL	3	6.1	II	279	1 ℓ	E2	P001	-	IBC02	-
1231	METHYL ACETATE	3	-	II	-	1 ℓ	E2	P001	-	IBC02	-
1233	METHYLAMYLACETATE	3	-	III	-	5 ℓ	E1	P001 LP01	-	IBC03	-
1234	METHYLAL	3	-	II	-	1 ℓ	E2	P001	88	IBC02	-
1235	METHYLAMINE, AQUEOUS SOLUTION	3	8	II	-	1 ℓ	E2	P001	-	IBC02	-
1237	METHYL BUTYRATE	3	-	II	-	1 ℓ	E2	P001	-	IBC02	-

UN No. (16)	Properties and Observations (17)	Portable tanks and bulk containers		Stowage and Segregation (16)	F-E, S-D	Category B. Clear of living quarters. Colourless to yellow liquids with a garflic odour. Immiscible with water. Toxic if swallowed, by skin contact or by inhalation.	1228
		Tank instructions (15)	Provisions (14)				
4.2.5 4.3		4.2.5 4.3	4.2.5 7.8	7.1 to 7.7	F-E, S-D	Category B. Clear of living quarters. Colourless to yellow liquids with a garflic odour. Immiscible with water. Toxic if swallowed, by skin contact or by inhalation.	1228
4.2.5 7.8		4.2.5 7.8	4.2.5 7.8	7.1 to 7.7	F-E, S-D	Category B. Clear of living quarters. Colourless to yellow liquids with a garflic odour. Immiscible with water. Toxic if swallowed, by skin contact or by inhalation.	1228

Category B. Clear of living quarters. Colourless to yellow liquids with a garflic odour. Immiscible with water. Toxic if swallowed, by skin contact or by inhalation.

2.3.4.2, 7.6.3.1.2 or 7.7.3.6. Separated from odour-absorbing carboys.

Category B. Clear of living quarters. Segregation from foodstuffs as in 2.3.4.2, 7.6.3.1.2 or 7.7.3.6. Separated from odour-absorbing carboys.

Category A.

Colourless, oily liquid with a sweet odour. Flashpoint: 32°C c.c. Miscible with water.

Category B. Clear of living quarters. Colourless, volatile liquid. Flashpoint: 12°C c.c. Explosive limits: 6% to 36.5%. Miscible with water. Toxic if swallowed, may cause blindness. Avoid skin contact.

Category B.

Colourless, volatile liquid with a fragrant odour. Flashpoint: -10°C c.c. Explosive limits: 3% to 16%. Miscible with water.

Category A.

Colourless liquid. Flashpoint: 43°C c.c. Immiscible with water.

Category E.

Colourless, volatile liquid with a chloroform-like odour. Flashpoint: -28°C c.c. Explosive limits: 3.6% to 12.6%. Boiling point: 42°C. Miscible with water. Irritating to skin, eyes and mucous membranes.

Category E. "Separated from" mercury and mercury compounds. Separated from acids.

Aqueous solution of a flammable gas having an ammonia-like odour. Explosive limits: 5% to 20.7% (pure product); boiling point: -7°C (pure product); flashpoint: 13°C c.c. Miscible with water. May react explosively with mercury. Harmful by inhalation. Reacts violently with acids. Causes burns to skin, eyes and mucous membranes.

Category B.

Colourless liquid. Flashpoint: 14°C c.c. Immiscible with water.

Category D. Clear of living quarters. Segregation as for Class 3 but "Away from" Class 4.1.

Colourless liquid. Flashpoint: 5°C c.c. Immiscible with water. Highly toxic if swallowed, by skin contact or by inhalation. Causes burns to skin, eyes and mucous membranes.

Category D. Clear of living quarters. Colourless liquid. Flashpoint: below -18°C c.c. Immiscible with water. Highly toxic if swallowed, by skin contact or by inhalation.

Category D. Clear of living quarters. Segregation as for Class 3 but "Away from" Classes 3.4.1 and 8.

Colourless, very volatile liquid with a pungent odour. Flashpoint: -26°C c.c. Explosive limits: 4.5% to 70%. Boiling point: 41°C. Immiscible with water. May react explosively with oxidizing agents. May react vigorously in contact with oxidizing substances. Causes burns to skin, eyes and mucous membranes.

Category E.

Colourless liquid with an agreeable odour. Flashpoint: -32°C c.c. Explosive limits: 5% to 22.7%. Boiling point: 32°C. Miscible with water.

Category D. Clear of living quarters. Segregation as for Class 3 but "Away from" Class 4.1 and Class 8. "Separated from" acids.

Colourless liquid with an ammonia-like odour. Flashpoint: 20°C c.c. Explosive limits: 2.5% to 98%. Miscible with water. Reacts violently with acids. May react dangerously with oxidizing substances. Highly toxic if swallowed, by skin contact or by inhalation. Causes burns to skin, eyes and mucous membranes.

Category E.

Colourless liquid with an ammonia-like odour. Flashpoint: 20°C c.c. Explosive limits: 2.5% to 98%. Miscible with water. Reacts violently with acids. May react dangerously with oxidizing substances. Highly toxic if swallowed, by skin contact or by inhalation. Causes burns to skin, eyes and mucous membranes.

UN No. (1)	PSN (2)	Class or Div (3)	Subsidiary Risk(s) (4)	Packing Group (5)	Special Provisions (6)	Limited quantities (7a)	Excepted quantities (7b)	Packing		IBC		Portable tanks and bulk containers			Properties and Observations (17)	UN No. (18)	
								Instruc-tions (8)	Provisions (9)	Instruc-tions (10)	Provisions (11)	Tank instructions (12)	Provisions (13)	EMS (15)			Stowage and Segregation (16)
	3.1.2	2.0	2.0	2.0, 1.3	3.3	3.4	3.5	4.1, 4	4.1, 4	4.1, 4	4.1, 4	T4	TP1	F-E, S-D	Category B.	Colourless liquid with a pleasant odour. Flashpoint: 14°C c.c. Explosive limits: 1.4% to 7.3%. Immiscible with water.	1245
		3	-	II	-	1 ℓ	E2	P001	-	IBC02	-	T4	TP1	F-E, S-D	Category B.	Colourless liquid with a pleasant odour. Flashpoint: 14°C c.c. Explosive limits: 1.4% to 7.3%. Immiscible with water.	1246
		3	-	II	-	1 ℓ	E2	P001	-	IBC02	-	T4	TP1	F-E, S-D	Category B.	Colourless liquid with a pleasant odour. Flashpoint: 8°C c.c. Explosive limits: 1.5% to 11.6%. Immiscible with water. Irritating to skin, eyes and mucous membranes.	1247
		3	-	II	-	1 ℓ	E2	P001	-	IBC02	-	T4	TP1	F-E, S-D	Category B.	Colourless liquid. Flashpoint: -2°C c.c. Explosive limits: 2.4% to 13%. Immiscible with water.	1248
		3	-	II	-	1 ℓ	E2	P001	-	IBC02	-	T4	TP1	F-E, S-D	Category B.	Colourless liquid. Flashpoint: 7°C c.c. Explosive limits: 1.5% to 8.2%. Immiscible with water.	1249
		3	8	II	-	0	E0	P010	-	-	-	T10	TP2 TP7 TP13	E-E, S-C	Category B. Clear of living quarters.	1250	
		6.1	3/8	I	354	0	E0	P601	-	-	-	T22	TP2 TP3 TP13 TP17	F-E, S-C	Category D. Clear of living quarters. Segregation as for Class 3 but "Away from" class 4.1.	1251	
		6.1	3	I	-	0	E5	P601	-	-	-	-	-	F-E, S-D	Category D. Clear of living quarters. "Separated longitudinally from other classes in the same compartment or hold from" Class 1.	Colourless or yellow, volatile, flammable liquid. Flashpoint: below -20°C c.c. Oxidizes in air and explodes at a temperature above 100°C c.c. Immiscible with water. Highly toxic if swallowed, by skin contact or by inhalation.	1259
		3	-	II	26	1 ℓ	E2	P001	-	-	-	-	-	F-E, S-D	Category A.	Colourless liquid. Flashpoint: 35°C c.c. Explosive limits: 7.1% to 62%. Miscible with water. Fire and explosion hazard if package is ruptured.	1261
		3	-	II	-	1 ℓ	E2	P001	-	IBC02	-	T4	TP1	F-E, S-E	Category B.	Colourless liquids. Explosive limits: 1% to 6.5%. ISOOCTANE: Flashpoint-12°C c.c. n-OCTANE: flashpoint 13°C c.c. Immiscible with water.	1262
		3	-	I	163	500 ml	E3	P001	-	-	-	T11	TP1 TP8 TP27	F-E, E	Category E.	Miscibility with water depends upon the composition.	1263
		3	-	II	163	5 ℓ	E2	P001	PP1	IBC02	-	T4	TP1 TP8 TP28	F-E, E	Category B.	See entry above.	1263
		3	-	III	163	5 ℓ	E1	P001	PP1	IBC03	-	T2	TP1 TP29	F-E, E	Category A.	See entry above.	1263
		3	-	III	-	5 ℓ	E1	P001	LP01	IBC03	-	T2	TP1	F-E, S-D	Category A.	Colourless liquid. Flashpoint: 27°C c.c. Explosive limits: 1.3% to... Miscible with water.	1264
		3	-	I	-	0	E3	P001	-	-	-	T11	TP2	F-E, S-D	Category E.	Colourless liquids with a non-flammable odour. Explosive limits: 1.4% to 8%. ISOPENTANE (METHYLBUTANE): boiling point 35°C c.c. Immiscible with water. Slightly irritating to skin, eyes and mucous membranes. Narcotic in high concentrations.	1265



UN No. (1)	PSN (2)	Class No. (3)	Subsidiary Risk(s) (4)	Packing Group (5)	Special Provisions (6)	Limited quantities (7a)	Excepted quantities (7b)	Packing			IBC			EMs (15)	Stowage and Segregation (16)	Properties and Observations (17)	UN No. (18)
								Class or Div. (5)	Institutions (8)	Provisions (9)	Institutions (10)	Provisions (11)	Tank instructions (12)				
	3.1.2	2.0	2.0	2.0, 1.3	3.3	3.4	3.5	4.1, 4	4.1, 4	4.1, 4	4.1, 4	4.3	4.2, 5	5.4, 5.2	7.1 to 7.7		
1265	PENTANES, liquid	3	-	II	-	1 ℓ	E2	P001	-	IBC02	-	T4	TP1	F-E, S-D	Category E	See entry above. Normal-PENTANE boiling point 36°C.	1265
1266	PERFUMERY PRODUCTS with flammable solvents	3	-	II	163	5 ℓ	E2	P001	-	IBC02	-	T4	TP1 TP8	F-E, S-D	Category B.	Miscibility with water depends upon the composition.	1266
1266	PERFUMERY PRODUCTS with flammable solvents	3	-	III	163 223 955	5 ℓ	E1	P001 LP01	-	IBC03	-	T2	TP1	F-E, S-D	Category A.	See entry above.	1266
1267	PETROLEUM CRUDE OIL	3	-	I	357	500 ml	E3	P001	-	-	-	T1,1	TP1 TP8	F-E, S-E	Category E.	Immiscible with water.	1267
1267	PETROLEUM CRUDE OIL	3	-	II	357	1 ℓ	E2	P001	-	IBC02	-	T4	TP1 TP8	F-E, S-E	Category B.	See entry above.	1267
1267	PETROLEUM CRUDE OIL	3	-	III	223 357	5 ℓ	E1	P001 LP01	-	IBC03	-	T2	TP1	F-E, S-E	Category A.	See entry above.	1267
1268	PETROLEUM DISTILLATES, N.O.S. or PETROLEUM PRODUCTS, N.O.S.	3	-	I	363	500 ml	E3	P001	-	-	-	T1,1	TP1 TP8	F-E, S-E	Category E.	Immiscible with water.	1268
1268	PETROLEUM DISTILLATES, N.O.S. or PETROLEUM PRODUCTS, N.O.S.	3	-	II	363	1 ℓ	E2	P001	-	IBC02	-	T7	TP1 TP8 TP28	F-E, S-E	Category B.	See entry above.	1268
1268	PETROLEUM DISTILLATES, N.O.S. or PETROLEUM PRODUCTS, N.O.S.	3	-	III	223 363 955	5 ℓ	E1	P001 LP01	-	IBC03	-	T4	TP1 TP29	F-E, S-E	Category A.	See entry above.	1268
1272	RNE OIL	3	-	III	-	5 ℓ	E1	P001 LP01	-	IBC03	-	T2	TP1	F-E, S-E	Category A.	Volatile oils, with characteristic odours. Flashpoint: 57°C to 60°C c.c. Immiscible with water.	1272
1274	n-PROPANOL (PROPYL ALCOHOL, NORMAL)	3	-	II	-	1 ℓ	E2	P001	-	IBC02	-	T4	TP1	F-E, S-D	Category B.	Colourless liquid. Explosive limits: 2% to 12%. Flashpoint: 15°C to 23°C c.c. Miscible with water.	1274
1274	n-PROPANOL (PROPYL ALCOHOL, NORMAL)	3	-	III	223	5 ℓ	E1	P001 LP01	-	IBC03	-	T2	TP1	F-E, S-D	Category A.	See entry above. Flashpoint: 23°C to 26°C c.c.	1274
1275	PROPIONALDEHYDE	3	-	II	-	1 ℓ	E2	P001	-	IBC02	-	T7	TP1	F-E, S-D	Category E.	Colourless liquid with a pungent odour. Flashpoint: below -18°C c.c. Explosive limits: 2.3% to 21%. Boiling point: 49°C. Miscible with water. Irritating to skin, eyes and mucous membranes.	1275
1276	n-PROPYL ACETATE	3	-	II	-	1 ℓ	E2	P001	-	IBC02	-	T4	TP1	F-E, S-D	Category B.	Colourless, clear liquid with a pleasant odour. Flashpoint: 10°C c.c. Explosive limits: 1.8% to 8%. Immiscible with water.	1276
1277	PROPYLAMINE	3	8	II	-	1 ℓ	E2	P001	-	IBC02	-	T7	TP1	F-E, S-C	Category E. Clear of living quarters.	Colourless liquid. Flashpoint: below -18°C c.c. Explosive limits: 2% to 10.4%. Boiling point: 48°C. Miscible with water. Harmful if swallowed. Causes burns to skin, eyes and mucous membranes.	1277
1278	1-CHLOROPROPANE	3	-	II	-	1 ℓ	E2	P001	-	IBC02	B8	T7	TP2	F-E, S-D	Category E.	Colourless liquid with a chloroform-like odour. Flashpoint: -18°C c.c. Explosive limits: 2.6% to 10.5%. Boiling point: 47°C. Immiscible with water.	1278

**TSFS 2015:66**  
**Bilaga 1**

UN No. (1)	PSN (2)	Class No. (3)	Subsidiary Risk(s) (4)	Packing Group (5)	Special Provisions (6)	Limited quantities (7a)	Excepted quantities (7b)	Packing			IBC	
								Instruc-tions (8)	Provisions (9)	Instruc-tions (10)	Provisions (11)	
	3.1.2	2.0	2.0	2.0, 1.3	3.3	3.4	3.5	4.1, 4	4.1, 4	4.1, 4		

UN No. (16)	Properties and Observations (17)	Portable tanks and bulk containers		Stowage and Segregation (16)	UN No. (16)
		Tank instructions (15)	Provisions (14)		
		4.2.5 4.3	4.2.5	5.4.5.2 7.8	

1279	1,2-DICHLOROPROPANE	3	-	II	-	1 ℓ	E2	P001	-	IBC02	-	T4	TP1	F-E, S-D	Category B.	Colourless liquid. Flashpoint: 15°C c.c. Immiscible with water. Harmful by inhalation. Irritating to skin and eyes.	1279
1280	PROPYLENE OXIDE	3	-	I	-	0	E3	P001	-	-	-	T11	TP2	F-E, S-D	Category E. Clear of living quarters.	Colourless, volatile liquid with an ether-like odour. Flashpoint: below -18°C c.c. Explosive limits: 2% to 22%. Boiling point: 34°C. Partially miscible with water.	1280
1281	PROPYL FORMATES	3	-	II	-	1 ℓ	E2	P001	-	IBC02	-	T4	TP1	F-E, S-D	Category B.	Colourless liquids with a pleasant odour. Explosive limits: 2.4% to 7.8%. Miscibility with water depends upon the composition. Irritating to skin, eyes and mucous membranes.	1281
1282	PYRIDINE	3	-	II	-	1 ℓ	E2	P001	-	IBC02	-	T4	TP2	F-E, S-D	Category B. Clear of living quarters.	Colourless or slightly yellow liquid with a pungent odour. Flashpoint: 17°C c.c. Explosive limits: 1.8% to 12.4%. Miscible with water. Harmful by inhalation.	1282
1286	ROSIN OIL	3	-	II	-	1 ℓ	E2	P001	-	IBC02	-	T4	TP1	F-E, S-E	Category B.	Colourless to brown viscous liquid. Immiscible with water.	1286
1286	ROSIN OIL	3	-	III	223	5 ℓ	E1	P001 LP01	-	IBC03	-	T2	TP1	F-E, S-E	Category A.	See entry above.	1286
1287	RUBBER SOLUTION	3	-	II	-	5 ℓ	E2	P001	-	IBC02	-	T4	TP1	F-E, S-D	Category B.	Miscibility with water depends upon the composition.	1287
1287	RUBBER SOLUTION	3	-	III	223	5 ℓ	E1	P001 LP01	-	IBC03	-	T2	TP1	F-E, S-D	Category A.	See entry above.	1287
1288	SHALE OIL	3	-	II	-	1 ℓ	E2	P001	-	IBC02	-	T4	TP1	F-E, S-E	Category B.	Immiscible with water.	1288
1288	SHALE OIL	3	-	III	223	5 L	E1	P001 LP01	-	IBC03	-	T2	TP1	F-E, S-E	Category A.	See entry above.	1288
1289	SODIUM METHYLATE SOLUTION in alcohol	3	8	II	-	1 ℓ	E2	P001	-	IBC02	-	T7	TP1	F-E, S-C	Category B.	Reacts violently with water. Causes burns to skin, eyes and mucous membranes.	1289
1289	SODIUM METHYLATE SOLUTION in alcohol	3	8	III	223	5 ℓ	E1	P001	-	IBC03	-	T4	TP1	F-E, S-C	Category A.	See entry above. Irritating to skin, eyes and mucous membranes.	1289
1292	TETRAETHYL SILICATE	3	-	III	-	5 ℓ	E1	P001 LP01	-	IBC03	-	T2	TP1	F-E, S-D	Category A.	Colourless liquid. Flashpoint: 37°C c.c. Explosive limits: 1.3% to 23%. Immiscible with water.	1292
1293	TINCTURES, MEDICINAL	3	-	II	-	1 ℓ	E2	P001	-	IBC02	-	T4	TP1	F-E, S-D	Category B.	Miscibility with water depends upon the composition.	1293
1293	TINCTURES, MEDICINAL	3	-	III	904	5 ℓ	E1	P001 LP01	-	IBC03	-	T2	TP1	F-E, S-D	Category A.	See entry above.	1293
1294	TOLUENE	3	-	II	-	1 ℓ	E2	P001	-	IBC02	-	T4	TP1	F-E, S-D	Category B.	Colourless liquid with a benzene-like odour. Flashpoint: 7°C c.c. Explosive limits: 1.27% to 7%. Immiscible with water.	1294

UN No. (1)	PSN (2)	IBC				Packing				Portable tanks and bulk containers			Properties and Observations (17)	UN No. (18)	
		Class or Div. (5)	Subsidiary Risk(s) (4)	Packing Group (3)	Special Provisions (6)	Limited quantities (7a)	Excepted quantities (7b)	Instruc-tions (8)	Provisions (9)	Instruc-tions (10)	Provisions (11)	Tank instructions (15)			Provisions (14)
	3.1.2	2.0	2.0	2.0, 1.3	3.3	3.4	3.5	4.1, 4	4.1, 4	4.1, 4	4.3	4.2, 5	54, 5.2	7.1 to 7.7	
1295	TRICHLOROSILANE	4.3	8/3	I	-	0	E0	P401	PPS1	-	-	T14	F-C, S-D	Category D. Clear of living quarters. Flashpoint: 32°C. Boiling point: 32°C. Reacts with water or steam to produce heat, which may lead to self-ignition; toxic and corrosive fumes will be evolved. May react vigorously in contact with oxidizing substances. Causes burns to skin, eyes and mucous membranes.	1295
1296	TRIMETHYLAMINE	3	8	II	-	1 ℓ	E2	P001	-	IBC02	-	T7	F-E, S-C	Category B. Clear of living quarters. Explosive limits: 1.2% to 8%. Miscible with water. Harmful by inhalation. Causes burns to skin and eyes. Irritating to mucous membranes.	1296
1297	TRIMETHYLAMINE, AQUEOUS SOLUTION not more than 50% trimethylamine, by mass	3	8	I	-	0	E0	P001	-	-	-	T11	F-E, S-C	Category D. Clear of living quarters. Flashpoint depending on percentage of dissolved gas. May react explosively with mercury. Miscible with water. An aqueous solution of 45% TRIMETHYLAMINE, by mass, has a flashpoint of -35°C c.c. and a boiling point of 3°C c.c. Causes burns to skin, eyes and mucous membranes.	1297
1297	TRIMETHYLAMINE, AQUEOUS SOLUTION not more than 50% trimethylamine, by mass	3	8	II	-	1 ℓ	E2	P001	-	IBC02	-	T7	F-E, S-C	Category B. Clear of living quarters. See entry above.	1297
1297	TRIMETHYLAMINE, AQUEOUS SOLUTION not more than 50% trimethylamine, by mass	3	8	III	223	5 ℓ	E1	P001	-	IBC03	-	T7	F-E, S-C	Category A. Clear of living quarters. See entry above. Irritating to skin, eyes and mucous membranes. Separated from mercury and mercury compounds.	1297
1298	TRIMETHYLCHLOROSILANE	3	8	II	-	0	E0	P010	-	-	-	T10	F-E, S-C	Category E. Clear of living quarters. Colourless liquid. Flashpoint: below -18°C c.c. Explosive limits: 1.8% to 8%. Boiling point: 57°C. Immiscible with water. Readily hydrolysed by moisture, evolving hydrogen chloride, a toxic and corrosive gas. Causes burns to skin, eyes and mucous membranes.	1298
1299	TURPENTINE	3	-	III	-	5 ℓ	E1	P001	-	IBC03	-	T2	F-E, S-E	Category A. Colourless liquid. Flashpoint: 35°C c.c. Mixture of resin and volatile oils. Immiscible with water.	1299
1300	TURPENTINE SUBSTITUTE	3	-	II	-	1 ℓ	E2	P001	-	IBC02	-	T4	F-E, S-E	Category B. Immiscible with water.	1300
1300	TURPENTINE SUBSTITUTE	3	-	III	223	5 ℓ	E1	P001	-	IBC03	-	T2	F-E, S-E	Category A. See entry above.	1300
1301	VINYL ACETATE, STABILIZED	3	-	II	-	1 ℓ	E2	P001	-	IBC02	-	T4	F-E, S-D	Category B. Colourless to light yellow liquid. Flashpoint: -8°C c.c. Explosive limits: 2.6% to 14%. Immiscible with water.	1301
1302	VINYL ETHER, STABILIZED	3	-	I	-	0	E3	P001	-	-	-	T11	F-E, S-D	Category D. Colourless liquid. Flashpoint: below -18°C c.c. Explosive limits: 1.7% to 28%. Boiling point: 33°C. Immiscible with water. Extremely reactive; may polymerize.	1302
1303	VINYLDIENE CHLORIDE, STABILIZED	3	P	I	-	0	E3	P001	-	-	-	T12	F-E, S-D	Category E. Clear of living quarters. Colourless to straw-coloured, volatile liquid with a sweet odour. Flashpoint: -28°C c.c. Explosive limits: 6.5% to 15.5%. Boiling point: 32°C. Immiscible with water.	1303
1304	VINYLSOBUTYL ETHER, STABILIZED	3	-	II	-	1 ℓ	E2	P001	-	IBC02	-	T4	F-E, S-D	Category B. Colourless liquid. Flashpoint: -9°C o.c. Immiscible with water.	1304
1305	VINYLTRICHLOROSILANE	3	8	II	-	0	E0	P010	-	-	-	T10	F-E, S-C	Category B. Clear of living quarters. Colourless, pale yellow or pink liquid with a pungent odour. Flashpoint: 17°C c.c. Boiling point: 35°C. Evolves irritating and corrosive gas upon contact with water, forming white fumes. Immiscible with water. In the presence of moisture, corrosive to most metals.	1305
1306	WOOD PRESERVATIVES, LIQUID	3	-	II	-	5 ℓ	E2	P001	-	IBC02	-	T4	F-E, S-D	Category B. Miscibility with water depends upon the composition. Harmful by inhalation.	1306

UN No. (1)	PSN (2)	Class or Div. (3)	Subsidiary Risk(s) (4)	Packing Group (5)	Special Provisions (6)	Limited quantities (7a)	Excepted quantities (7b)	Packing		IBC	
								Instructions (8)	Provisions (9)	Instructions (10)	Provisions (11)
3.1.2		2.0	2.0	2.0, 1.3	3.3	3.4	3.5	4.1, 4	4.1, 4	4.1, 4	

Tank instructions (15)	Provisions (14)	EMs (15)	Stowage and Segregation (16)	Properties and Observations (17)

UN No. (1)	PSN (2)	Class or Div. (3)	Subsidiary Risk(s) (4)	Packing Group (5)	Special Provisions (6)	Limited quantities (7a)	Excepted quantities (7b)	Instructions (8)	Provisions (9)	Instructions (10)	Provisions (11)	Tank instructions (15)	Provisions (14)	EMs (15)	Stowage and Segregation (16)	Properties and Observations (17)	
1306	WOOD PRESERVATIVES, LIQUID	3	-	III	223 555	5 ℓ	E1	P001 LP01	-	IBC03	-	T2	TP1	F-E, S-D	Category A.	See entry above.	1306
1307	XYLENES	3	-	II	-	1 ℓ	E2	P001	-	IBC02	-	T4	TP1	F-E, S-D	Category B.	Colorless liquids. Flashpoint: 17°C to 23°C. Explosive limits: 1.1% to 7%, immiscible with water.	1307
1307	XYLENES	3	-	III	223	5 ℓ	E1	P001 LP01	-	IBC03	-	T2	TP1	F-E, S-D	Category A.	See entry above. Flashpoint: 23°C to 30°C. C.	1307
1308	ZIRCONIUM, SUSPENDED IN A FLAMMABLE LIQUID	3	-	I	-	0	E3	P001	PP3	-	-	-	-	F-E, S-D	Category D.	Finely divided zirconium metal in a flammable liquid. Immiscible with water. Spillage is liable to self-ignition.	1308
1308	ZIRCONIUM, SUSPENDED IN A FLAMMABLE LIQUID	3	-	II	-	1 ℓ	E2	P001	PP3	-	-	-	-	F-E, S-D	Category B.	See entry above.	1308
1308	ZIRCONIUM, SUSPENDED IN A FLAMMABLE LIQUID	3	-	III	223	5 ℓ	E1	P001	-	-	-	-	-	F-E, S-D	Category B.	See entry above.	1308
1309	ALUMINIUM POWDER, COATED	4.1	-	II	-	1 kg	E2	P002 LP02	PP38	IBC08	B2 B4	T3	TP33	F-G, S-C	Category A. Keep as dry as reasonably practicable. "Away from liquid halogenated hydrocarbons." "Separated from" "oxidizing agents, acids, alkalis and iron oxide."	If uncoded it possesses the property of evolving hydrogen gas when in contact with water, especially seawater; if treated with oil or wax it does not at ordinary temperatures. Reacts readily with acids and caustic alkalis, evolving hydrogen, a flammable gas. Reacts readily with iron oxide and other oxidizing agents. In the event of breakage of receptacles, the scattered powder is readily ignited by sparks or open flame and may give rise to an explosive atmosphere.	1309
1309	ALUMINIUM POWDER, COATED	4.1	-	III	223	5 kg	E1	P002 LP02	PP38	IBC08	B3	T1	TP33	F-G, S-C	Category A. Keep as dry as reasonably practicable. "Away from liquid halogenated hydrocarbons." "Separated from" "oxidizing agents, acids, alkalis and iron oxide."	See entry above.	1309
1310	AMMONIUM PICRATE, WETTED with not less than 10% water, by mass	4.1	-	I	28	0	E0	P406 PP31	-	-	-	-	-	F-B, S-J	Category D. "Away from" class 3 and heavy metals and their salts.	Desensitized explosive. Substance in pure form consists of yellow crystals. Explosive and sensitive to friction in the dry state. May form extremely sensitive compounds with heavy metals or their salts. Harmful if swallowed or by skin contact.	1310
1312	BORNEOL	4.1	-	III	-	5 kg	E1	P002 LP02	-	IBC08	B3	T1	TP33	F-A, S-I	Category A.	White, translucent lumps. Camphor-like odour. Insoluble in water. Harmful by ingestion.	1312
1313	CALCIUM RESINATE	4.1	-	III	-	5 kg	E1	P002	-	IBC06	-	T1	TP33	F-A, S-I	Category A.	Yellowish-white, amorphous powder or lumps. Insoluble in water. Liable to spontaneous heating. Irritating to skin and mucous membranes.	1313
1314	CALCIUM RESINATE, RISED	4.1	-	III	-	5 kg	E1	P002	-	IBC04	-	T1	TP33	F-A, S-I	Category A.	Yellowish-white, amorphous powder or lumps. Insoluble in water. Liable to spontaneous heating. Irritating to skin and mucous membranes.	1314
1318	COBALT RESINATE, PRECIPITATED	4.1	-	III	-	5 kg	E1	P002	-	IBC06	-	T1	TP33	F-A, S-I	Category A.	Dark brownish-black solid. Insoluble in water. Readily combustible; may ignite spontaneously if contaminated with vegetable fibres (such as cotton). Irritating to skin and mucous membranes.	1318
1320	DINITROPHENOL, WETTED with not less than 15% water, by mass	4.1	6.1 P	I	28	0	E0	P406 PP31	PP31	-	-	-	-	F-B, S-J	Category E. "Away from" class 3 and heavy metals and their salts.	Desensitized explosive. Substance when pure consists of yellow crystals. Slightly soluble in water. May form extremely sensitive compounds with heavy metals or their salts. Toxic if swallowed; by skin contact or by inhalation.	1320
1321	DINITROPHENOLATES, WETTED with not less than 15% water, by mass	4.1	6.1 P	I	28	0	E0	P406 PP31	PP31	-	-	-	-	F-B, S-J	Category E. "Away from" class 3 and heavy metals and their salts.	Desensitized explosives. Explosive and sensitive to friction in the dry state. May form extremely sensitive compounds with heavy metals or their salts. Toxic if swallowed; by skin contact or by inhalation.	1321

UN No. (1)	PSN (2)	Class No. (3)	Subsidiary Risk(s) (4)	Packing Group (5)	Special Provisions (6)	Limited quantities (7a)	Excepted quantities (7b)	Packing			IBC			Proportions (14)	EMs (15)	Stowage and Segregation (16)	Properties and Observations (17)	UN No. (18)
								Class (8)	Institutions (9)	Provisions (10)	Institutions (11)	Provisions (12)	Institutions (13)					
1322	DINITRORESORCINOL, WETTED with not less than 15% water, by mass	4.1	-	I	28	0	E0	P406	PP16 PP1	-	-	-	-	F-B, S-J	Category E. "Away from" class 3 and heavy metals and their salts.	Desensitized explosive. Harmful if swallowed or by skin contact.	1322	
1323	FERROCERIUM	4.1	-	II	249	1 kg	E2	P002	-	IBC08	B2 B4	TP33	F-C, S-C	Category A.	Alloy derived from cerium or mischmetal, with the addition of 10% to 65% iron. Emits sparks when struck.	Harmful if swallowed or by skin contact.	1323	
1324	FILMS, NITROCELLULOSE BASE gelatin coated, except scrap	4.1	-	III	-	5 kg	E1	P002	PP15	-	-	-	-	F-A, S-I	Category D. "Away from" class 3.	Ignites readily. When involved in a fire, evolves toxic fumes; in closed compartments, these fumes may form an explosive mixture with air.	1324	
1325	FLAMMABLE SOLID, ORGANIC, N.O.S.	4.1	-	II	274 915	1 kg	E2	P002	-	IBC08	B2 B4	TP33	F-A, S-C	Category B.	-	-	1325	
1325	FLAMMABLE SOLID, ORGANIC, N.O.S.	4.1	-	III	223 274 915	5 kg	E1	P002	-	IBC08	B3	TP33	F-A, S-C	Category B.	-	-	1325	
1326	HAFNIUM POWDER, WETTED with not less than 25% water (a visible excess of water must be present) (a) mechanically produced, particle size less than 53 microns; (b) chemically produced, particle size less than 840 microns	4.1	-	II	916	1 kg	E2	P410	PP3 PM40	IBC06	B2	TP33	F-A, S-J	Category E. "Separated from" class 5.1.	Insoluble in water. Liable to spontaneous combustion when dry. Forms explosive mixtures with oxidizing substances.	Insoluble in water. Liable to spontaneous combustion when wet. damp or contaminated with oil. Refuse for shipment when loose, damp, wet or contaminated with oil.	1326	
1327	HAY, STRAW or BHUSA	4.1	-	-	29 281 954	3 kg	E0	P003	PP19	IBC08	B6	-	-	F-A, S-I	Category A. "Away from" animal or vegetable oils. Unless carried in closed cargo transport units, bales shall be properly covered by tarpaulins or the like. Cargo spaces containing hay, straw or bales shall be properly covered with tarpaulins or grease. Ventilator cowls leading into the cargo space shall have spark-preventing screens. All other openings, air intakes and electrical connections shall be properly secured. During temporary interruption of loading, when the hatch remains uncovered, a fire-hatch shall be closed. Smoking, drinking or discharge, smoking in the vicinity shall be prohibited and fire-fighting appliances kept ready for immediate operation.	Category A. "Separated from" class 5.1.	Category A. "Away from" animal or vegetable oils. Unless carried in closed cargo transport units, bales shall be properly covered by tarpaulins or the like. Cargo spaces containing hay, straw or bales shall be properly covered with tarpaulins or grease. Ventilator cowls leading into the cargo space shall have spark-preventing screens. All other openings, air intakes and electrical connections shall be properly secured. During temporary interruption of loading, when the hatch remains uncovered, a fire-hatch shall be closed. Smoking, drinking or discharge, smoking in the vicinity shall be prohibited and fire-fighting appliances kept ready for immediate operation.	1327
1328	HEXAMETHYLENETETRAMINE	4.1	-	III	-	5 kg	E1	P002	-	IBC08	B3	TP33	F-A, S-C	Category A.	White, crystalline powder. Soluble in water.	-	1328	
1330	MANGANESE RESINATE	4.1	-	III	-	5 kg	E1	P002	-	IBC06	-	TP33	F-A, S-I	Category A.	Very dark brown solid. Insoluble in water. Liable to spontaneous heating. Irritating to skin, eyes and mucous membranes.	-	1330	
1331	MATCHES, "STRIKANYWHERE"	4.1	-	III	293	5 kg	E1	P407	PP27	-	-	-	-	F-A, S-I	Category B.	Ignite by friction; prepared surface is not required.	1331	
1332	METALDHYDE	4.1	-	III	-	5 kg	E1	P002	LP02	IBC08	B3	TP33	F-A, S-C	Category A.	White crystals, powder or tablets. Insoluble in water. Harmful if swallowed or by dust inhalation.	-	1332	
1333	CERIUM slabs, ingots or rods	4.1	-	II	-	1 kg	E2	P002	-	IBC08	B2 B4	-	-	F-G, S-P	Category A. "Separated from" classes 3 and 5.1.	Contains 94%-99% rare earth metals. In contact with water or moist air, evolves hydrogen, a flammable gas. Emits sparks when scratched or struck.	1333	
1334	NAPHTHALENE, CRUDE or NAPHTHALENE, REFINED	4.1	-	III	948 967	5 kg	E1	P002	LP02	IBC08	B3	TP33	F-A, S-C	Category A.	Crystalline flakes or powder with a persistent odour. Evolves flammable vapours at or below, its melting point.	Category A. When transported in BKG bulk container, see 7.6.2.12 and 7.7.3.9.	1334	

**TSFS 2015:66**  
**Bilaga 1**

UN No. (1)	PSN (2)	Class No. or Div (5)	Subsidiary Risk(s) (4)	Packing Group (3)	Special Provisions (6)	Limited quantities (7a)	Excepted quantities (7b)	Packing		IBC		Tank instructions (15)	Provisions (14)	Ems (15)	Stowage and Segregation (16)	Properties and Observations (17)	UN No. (18)
								Instructions (8)	Provisions (9)	Instructions (10)	Provisions (11)						
1336	NITROGLANDIENE (PICRITEL), WETTED with not less than 20% water, by mass	4.1	-	I	28	0	EO	P406	PP31	-	-	-	-	F-B, S-J	Category E: "Away from" class 3 and heavy metals and their salts.	Desensitized explosive. White solid. When involved in a fire, evolves toxic and irritating fumes. May form extremely sensitive compounds with heavy metals or their salts.	1336
1337	NITROSTARCH, WETTED with not less than 20% water, by mass	4.1	-	I	28	0	EO	P406	PP31	-	-	-	-	F-B, S-J	Category D: "Away from" class 3 and heavy metals and their salts.	Desensitized explosive. Orange powder. Explosive and sensitive to friction in the dry state. When involved in a fire, evolves toxic fumes; in closed compartments these fumes may form an explosive mixture with air. May form extremely sensitive compounds, with heavy metals or their salts.	1337
1338	PHOSPHORUS, AMORPHOUS	4.1	-	III	-	5 kg	E1	P410	-	IBC08	B3	T1	TP33	F-A, S-C	"Separated from" class 5.1.	Reddish-brown powder, insoluble in water. Ignites readily by friction. When involved in a fire, evolves irritating fumes. Forms explosive mixtures with oxidizing substances. Harmful if swallowed or by dust inhalation.	1338
1339	PHOSPHORUS HEPTASULPHIDE free from yellow or white phosphorus	4.1	-	II	-	1 kg	E2	P410	PP31	IBC04	-	T3	TP33	F-G, S-C	Category B: "Separated from" class 5.1.	Yellow solid, ignites readily by friction. Develops heat in contact with moist air, evolving toxic and flammable gases. Forms explosive mixtures with oxidizing substances. Harmful if swallowed or by dust inhalation.	1339
1340	PHOSPHORUS PENTASULPHIDE free from yellow or white phosphorus	4.3	4.1	II	-	500 g	E2	P410	PP31 PH40	IBC04	-	T3	TP33	F-G, S-N	Category D.	Yellow solid, ignites readily by friction. Develops heat in contact with moist air, evolving toxic and flammable gases. Forms explosive mixtures with oxidizing substances. Harmful if swallowed or by dust inhalation.	1340
1341	PHOSPHORUS SESQUISULPHIDE free from yellow or white phosphorus	4.1	-	II	-	1 kg	E2	P410	PP31	IBC04	-	T3	TP33	F-A, S-C	Category B: "Separated from" class 5.1.	Yellow solid, ignites readily by friction. Develops heat in contact with moist air, evolving toxic and flammable gases. Harmful if swallowed or by dust inhalation.	1341
1343	PHOSPHORUS TRISULPHIDE free from yellow or white phosphorus	4.1	-	II	-	1 kg	E2	P410	PP31	IBC04	-	T3	TP33	F-G, S-C	Category B: "Separated from" class 5.1.	Yellow solid, ignites readily by friction. Develops heat in contact with moist air, evolving toxic and flammable gases. Forms explosive mixtures with oxidizing substances. Harmful if swallowed or by dust inhalation.	1343
1344	TRINITROPHENOL (PICRIC ACID), WETTED with not less than 30% water, by mass	4.1	-	I	28	0	EO	P406	PP26 PP31	IBC04	-	-	-	F-B, S-J	Category E: "Away from" class 3 and heavy metals and their salts.	Desensitized explosive. Substance in pure form consists of yellow crystals. Soluble in water. When involved in a fire, evolves toxic and irritating fumes. Harmful if swallowed or by skin contact.	1344
1345	RUBBER SCRAP powdered or granulated, not exceeding 800 microns and rubber content exceeding 45% or RUBBER SHODDY powdered or granulated, not exceeding 840 microns and rubber content exceeding 45%	4.1	-	II	23 917	1 kg	E2	P002	-	IBC08	B2 B4	T3	TP33	F-A, S-I	Category A.	Liable to spontaneous heating.	1345
1346	SILICON POWDER, AMORPHOUS	4.1	-	III	32	5 kg	E1	P002 LPO2	-	IBC08	B3	T1	TP33	F-A, S-C	Category A: "Separated from" class 5.1.	Dark brown, non-metallic powder. Burns in air, when ignited, readily flammable when mixed with oxidizing substances.	1346
1347	SILVER PICRATE, WETTED with not less than 30% water, by mass	4.1	-	I	28 900	0	EO	P406	PP25 PP26 PP31	-	-	-	-	F-B, S-J	Category D: "Away from" class 3 and heavy metals and their salts.	Desensitized explosive. Yellow crystals. Soluble in water. Explosive and sensitive to friction in the dry state. Harmful if swallowed or by skin contact. May form extremely sensitive compounds with heavy metals or their salts. Transport of SILVER PICRATE, dry or wetted with less than 30% water, by mass is prohibited.	1347
1348	SODIUM DINITRO- <i>o</i> -CRESOLATE, WETTED with not less than 15% water, by mass	4.1	6.1 P	I	28	0	EO	P406	PP26 PP31	-	-	-	-	F-B, S-J	Category E: "Away from" class 3 and heavy metals and their salts.	Desensitized explosives. Substance in dry form consists of yellow powder. Explosive and sensitive to friction in the dry state. May form extremely sensitive compounds with heavy metals or their salts. When involved in a fire, evolves toxic fumes; in closed compartments, these fumes may form an explosive mixture with air. Toxic if swallowed; by skin contact or by inhalation.	1348
1349	SODIUM PICRAMATE, WETTED with not less than 20% water, by mass	4.1	-	I	28	0	EO	P406	PP26 PP31	-	-	-	-	F-B, S-J	Category E: "Away from" class 3 and heavy metals and their salts.	Desensitized explosive. Substance in pure form consists of yellow powder. Explosive and sensitive to friction in the dry state. May form extremely sensitive compounds with heavy metals or their salts. When involved in a fire, evolves toxic fumes; in closed compartments, these fumes may form an explosive mixture with air. Harmful if swallowed or by skin contact.	1349
1350	SULPHUR	4.1	-	III	242 967	5 kg	E1	P002 LPO2	-	IBC08	B3	T1	TP33	F-A, S-C	Category A: Protected from sources of heat. "Separated from" class 5.1.	When involved in a fire, evolves toxic, very irritating and suffocating gas. static electricity. Forms explosive mixtures with oxidizing substances. Harmful if swallowed. Transported in bulk containers, see 7.6.2.1.2 and 7.7.3.9. Containers must be closed. Provisions of this Code should not apply to sulphur when it is formed to a specific shape (such as prills, granules, pellets, pastilles or flakes).	1350

UN No. (1)	PSN (2)	Class No. (3)	Subsidiary Risk(s) (4)	Packing Group (5)	Special Provisions (6)	Limited quantities (7a)	Excepted quantities (7b)	Packing		IBC		Tank instructions (15)	Provisors (14)	EMs (15)	Stowage and Segregation (16)	Properties and Observations (17)	UN No. (18)
								Instructions (8)	Institutions (9)	Institutions (10)	Provisions (11)						
1352	TITANIUM POWDER, WETTED with not less than 25% water, by mass (a) mechanically produced, particle size less than 53 microns (b) chemically produced, particle size less than 840 microns	4.1	-	II	28 316	1 kg	E2	P410	PP31 PM40	IBC06	B2	T3	TP33	F-A, S-J	Category E - "Separated from" class 3.1.	Grey powder. Forms explosive mixtures with oxidizing substances.	1352
1353	FIBRES OF FABRICS IMPREGNATED WITH WEAKLY NITRATED NITROCELLULOSE, N.O.S.	4.1	-	III	-	5 kg	E1	P410	-	IBC08	B3	-	-	F-A, S-J	Category D.	The board used in the manufacture of boots and shoes. When involved in a fire, evolves toxic fumes; in closed compartments, these fumes may form an explosive mixture with air.	1353
1354	TRINITROBENZENE, WETTED with not less than 30% water, by mass	4.1	-	I	28	0	EO	P406	PP31	-	-	-	-	F-B, S-J	Category E - "Away from" class 3 and heavy metals and their salts.	Desensitized explosive. Substance in pure form consists of yellow crystals. When involved in a fire, evolves toxic fumes; in closed compartments these fumes may form an explosive mixture with air. Explosive and sensitive to friction in the dry state. May form extremely sensitive compounds with heavy metals or their salts. Harmful if swallowed or by skin contact.	1354
1355	TRINITROBENZOIC ACID, WETTED with not less than 30% water, by mass	4.1	-	I	28	0	EO	P406	PP31	-	-	-	-	F-B, S-J	Category E - "Away from" class 3 and heavy metals and their salts.	Desensitized explosive. Substance in pure form consists of yellow crystals. Soluble in water. When involved in a fire, evolves toxic fumes; in closed compartments these fumes may form an explosive mixture with air. Explosive and sensitive to friction in the dry state. May form extremely sensitive compounds with heavy metals or their salts.	1355
1356	TRINITROTOLUENE (TNT), WETTED with not less than 30% water, by mass	4.1	-	I	28	0	EO	P406	PP31	-	-	-	-	F-B, S-J	Category E - "Away from" class 3 and heavy metals and their salts.	Desensitized explosive. Substance in pure form consists of yellow crystals. Soluble in water. When involved in a fire, evolves toxic fumes; in closed compartments these fumes may form an explosive mixture with air. Explosive and sensitive to friction in the dry state. May form extremely sensitive compounds with heavy metals or their salts. Harmful if swallowed or by skin contact.	1356
1357	UREA NITRATE, WETTED with not less than 20% water, by mass	4.1	-	I	28 227 319	0	EO	P406	PP31	-	-	-	-	F-B, S-J	Category E - "Away from" class 3 and heavy metals and their salts.	Desensitized explosive. Substance in pure form consists of white crystals. Soluble in water. When involved in a fire, evolves toxic fumes; in closed compartments these fumes may form an explosive mixture with air. Explosive and sensitive to friction in the dry state. May form extremely sensitive compounds with heavy metals or their salts.	1357
1358	ZIRCONIUM POWDER, WETTED with not less than 25% water (a visible excess of water must be present) (a) mechanically produced, particle size less than 53 microns (b) chemically produced, particle size less than 840 microns	4.1	-	II	916	1 kg	E2	P410	PP31 PM40	IBC06	B2	T3	TP33	F-G, S-J	Category E - "Separated from" class 5.1.	Grey powder. Insoluble in water. Liable to spontaneous combustion when dry. Forms explosive mixtures with oxidizing substances.	1358
1360	CALCIUM PHOSPHIDE	4.3	6.1	I	-	0	EO	P403	PP31	-	-	-	-	F-G, S-N	Category E - "Under deck in a mechanically ventilated space. Clear of living quarters. "Separated from" acids.	Red to brown crystals. Reacts with acids or decomposes slowly in contact with water or damp air, evolving phosphine, a spontaneously flammable and highly toxic gas. Reacts violently with oxidizing substances. Toxic if swallowed, by skin contact or by inhalation.	1360
1361	CARBON animal or vegetable origin	4.2	-	II	925	0	E2	P002	PP12	IBC06	-	T3	TP33	F-A, S-J	Category A. Keep as cool as possible.	Black powder or granules. Liable to heat slowly and ignite spontaneously in air. The material as offered for shipment should have been sufficiently heat-treated and should be cooled down to ambient temperature before packing.	1361
1361	CARBON animal or vegetable origin	4.2	-	III	223 325	0	E1	P002 LP02	PP12	IBC08	B3	T1	TP33	F-A, S-J	Category A. Keep as cool as possible.	See entry above.	1361
1362	CARBON, ACTIVATED	4.2	-	III	223 325	0	E1	P002	PP11 PP31	IBC06	B3	T1	TP33	F-A, S-J	Category A. Keep as cool as possible.	Black powder or granules. Liable to heat slowly and ignite spontaneously in air. The material as offered for shipment should be sufficiently heat-treated and should be cooled down to ambient temperature before packing.	1362
1363	COPRA	4.2	-	III	29 326	0	E1	P002 LP02	PP20	IBC08	B3 B6	BK2	-	F-A, S-J	Category A. Keep as dry as reasonably practicable. Protected from sources of heat. Provide a good thorough ventilation for bagged cargo. Double strapping is required. The illustration in 7.6.2.2.3 shows how this can be achieved. During the voyage regular temperature readings shall be taken at intervals of not more than 24 hours. If the temperature of the cargo exceeds the ambient temperature and continues to increase, ventilations shall be closed down.	Dried kernels of copra, with a penetrating rancid odour which may taint other cargoes.	1363

**TSFS 2015:66  
Bilaga 1**

UN No. (1)	PSN (2)	Class No. (5)	Subsidiary Risk(s) (4)	Packing Group (3)	Special Provisions (6)	Limited quantities (7a)	Excepted quantities (7b)	Packing		IBC		Portable tanks and bulk containers	Ems (15)	Stowage and Segregation (16)	Properties and Observations (17)	UN No. (18)	
								Instruc-tions (8)	Provisions (9)	Instruc-tions (10)	Provisions (11)						Tank instructions (12)
1364	COTTON WASTE, OILY	4.2	-	III	29	0	E1	P003 LPO2	P019	IBC08	B3 B6	-	F-A, S-J	Category A. "Separated from" animal or vegetable oil.	Fibres of vegetable origin.	1364	
1365	COTTON, WET	4.2	-	III	29	0	E1	P003	P019	IBC08	B3 B6	-	F-A, S-J	Category A.	Really combustible, liable to ignite spontaneously according to moisture content.	1365	
1369	p-NITROSODIMETHYLANILINE	4.2	-	II	927	0	E2	P410	-	IBC06	B2	T3	TP93	F-A, S-J	Category D. Segregation from foodstuffs as in 7.4.3.4.2, 7.6.3.1.2 or 7.7.3.6.	Dark green, crystalline solid. Insoluble in water. Ignites spontaneously in air when dry. Harmful if swallowed.	1369
1372	FIBRES ANIMAL or FIBRES VEGETABLE burnt, wet or damp	4.2	-	III	117	0	E1	P410	-	-	-	-	-	F-A, S-J	Category A.	Liable to ignite spontaneously according to moisture content.	1372
1373	FIBRES or FABRICS, ANIMAL or VEGETABLE or SYNTHETIC, N.O.S. with oil	4.2	-	III	-	0	E1	P410	P031	IBC08	B3	T1	TP93	F-A, S-J	Category A.	Liable to ignite spontaneously according to the oil content.	1373
1374	FISHMEAL, UNSTABILIZED or FISHSCRAP, UNSTABILIZED High hazard. Unrestricted moisture content. Unrestricted fat content. Unrestricted protein content. Unrestricted fat content in excess of 15% by mass, in the case of anti-oxidant treated fishmeal or fish scrap	4.2	-	II	928 300	0	E2	P410	P031 P040	IBC08	B2 B4	T3	TP33	F-A, S-J	Category B. "Separated by a complete compartment or hold" provisions as in 7.4.3.4.2, 7.6.3.1.2, 7.7.3.6.1.4. For special stowage provisions see 7.4.1.3 and 7.6.2.7.2. Protected from sources of heat.	Brown to greenish-brown product derived from oily fish. Strong odour which may affect other cargo. Liable to heat and ignite spontaneously.	1374
1374	FISHMEAL, UNSTABILIZED or FISHSCRAP, UNSTABILIZED Not anti-oxidant treated. Moisture content: more than 5% but not more than 12%, by mass. Fat content: not more than 15%, by mass.	4.2	-	III	29 300 907 928	0	E1	P410	P031	IBC08	B2 B3	T1	TP33	F-A, S-J	Category A. For special stowage provisions see 7.4.1.3 and 7.6.2.7.2. Protected from sources of heat.	see entry above.	1374
1376	IRON OXIDE, SPENT or IRON SPONGE, SPENT obtained from coal gas purification	4.2	-	III	223	0	E1	P002 LPO2	-	IBC08	B3	T1 B02	TP33	F-C, S-P	Category E	Obtained from coal gas purification. Strong odour which may irritate other cargo. Liable to heat and ignite spontaneously. This substance should have been cooled and weathered for not less than eight weeks before shipment, unless packed in a metal drum.	1376
1378	METAL CATALYST, WETTED with a visible excess of liquid	4.2	-	II	274	0	E2	P410	P031 P039 P040	IBC01	-	T3	TP33	F-H, S-M	Category C.	Liable to ignite spontaneously if dry.	1378
1379	PAPER, UNSATURATED OIL TREATED incompletely dried (including carbon paper)	4.2	-	III	-	0	E1	P410	P031	IBC08	B3	-	-	F-A, S-J	Category A.	Liable to ignite spontaneously. The provisions of this Code should not apply to manufactured articles properly aged.	1379
1380	PENTABORANE	4.2	6.1	I	-	0	E0	P601	-	-	-	-	-	F-G, S-L	Category D.	Colourless liquid. Boiling point range, 48°C to 63°C. Ignites spontaneously in air. Decomposes in contact with water, evolving hydrogen, a flammable gas. Toxic if swallowed, by skin contact or by inhalation.	1380
1381	PHOSPHORUS, WHITE or YELLOW, DRY or UNDERWATER or IN SOLUTION	4.2	6.1	I	-	0	E0	P405	P031	-	-	T9	TP3 TP31	F-A, S-J	Category E.	Ignites spontaneously in air. Melting point: 44°C. Toxic if swallowed, by skin contact or by inhalation. Liable to heat and ignite spontaneously in the liquid state which subsequently solidifies. A sufficient ullage should be allowed.	1381
1382	POTASSIUM SULPHIDE, ANHYDROUS or POTASSIUM SULPHIDE with less than 30% water of crystallization	4.2	-	II	-	0	E2	P410	P031 P040	IBC06	B2	T3	TP93	F-A, S-J	Category A. "Separated from" acids.	Black solid, absorbs moisture to become crystalline. Liable to ignite spontaneously in air. Evolves hydrogen sulphide, a toxic and flammable gas. Reacts violently with acids.	1382
1383	PYROPHORIC METAL, N.O.S. or PYROPHORIC ALLOY, N.O.S.	4.2	-	I	274	0	E0	P404	P031	-	-	T21 TP93	TP7 TP93	F-C, S-M	Category D.	Liable to ignite spontaneously in air. If shaken, may produce sparks. In contact with water, evolve hydrogen, a flammable gas.	1383
1384	SODIUM DITHIONITE SODIUM HYDROSULPHITE	4.2	-	II	-	0	E2	P410	P031	IBC06	B2	T3	TP93	F-A, S-J	Category E. Keep as dry as reasonably practicable.	White or grey crystalline powder. Liable to heat and ignite spontaneously in air and to evolve sulphur dioxide, an irritating gas.	1384



UN No. (1)	PSN (2)	Class No. (3)	Subsidiary Risk(s) (4)	Packing Group (5)	Special Provisions (6)	Limited quantities (7a)	Excepted quantities (7b)	Packing		IBC		Portable tanks and bulk containers		EMS (15)	Stowage and Segregation (16)	Properties and Observations (17)	UN No. (18)	
								Instruc-tions (8)	Provisions (9)	Instruc-tions (10)	Provisions (11)	Tank instructions (12)	Provisions (13)					F-A, S-J (14)
	3.1.2	2.0	2.0	2.0	2.0	3.3	3.4	3.5	4.1, 4	4.1, 4	4.1, 4	4.3	4.2, 4.3	54, 52	7.8	7.1 to 7.7		
1385	SODIUM SULPHIDE, ANHYDROUS or SODIUM SULPHIDE with less than 20% water of crystallization	4.2	-	II	-	0	E2	P410	PP31	IBC06	B2	T3	TP33	F-A, S-J	Category A. "Separated from" acids.	Black solid, absorbs moisture to become crystalline. In contact with acids, evolves hydrogen sulphide, a toxic and flammable gas. Reacts violently with acids.	1385	
1386	SEED CAKE, containing vegetable oil (a) mechanically expelled seeds, containing more than 10% oil or more than 20% oil and moisture combined	4.2	-	III	29	929	E1	P003	PP20	IBC08	B3	BK2	-	F-A, S-J	Category E. Keep dry. Protected from sources of heat. For special storage provisions see 7.6.2.7.2.	Residue remaining after oil has been expelled mechanically from oil-bearing seeds. Used mainly as animal feed or fertilizer. The most common seed cakes include those derived from coconut (copra), cottonseed, groundnut (peanut), linseed, maize (blowing crop) riger seed, rapeseed, sunflower seed, and soybean. They may be shipped in the form of cake, flakes, pellets, meal etc. May self-heat slowly and, if wet or containing an excessive proportion of unoxidized oil, ignite spontaneously. Before shipment this cargo should be protected from sources of heat. Smoking and the use of naked lights should be prohibited during loading and unloading and an entry to the cargo space (s) at any time.	1386	
1386	SEED CAKE, containing vegetable oil (b) solvent extractions and expelled seeds, containing not more than 10% of oil and when the amount of moisture is higher than 10%, not more than 20% of oil and moisture combined	4.2	-	III	29	929	E1	P003	PP20	IBC08	B3	BK2	-	F-A, S-J	Category A. Keep dry. Protected from sources of heat. For special storage provisions, see 7.6.2.7.2.	Residue remaining after oil has been extracted by a solvent process or expelled mechanically from oil-bearing seeds. Used mainly as animal feed or fertilizer. The most common seed cakes include those derived from coconut (copra), cottonseed, groundnut (peanut), linseed, maize (blowing crop) riger seed, rapeseed, sunflower seed and soybean. They may be shipped in the form of cake, flakes, pellets, meal etc. May self-heat slowly and, if wet or containing an excessive proportion of unoxidized oil, ignite spontaneously. The seed cake should be substantially free from flammable solvent. Before shipment this cargo should be protected from sources of heat. Smoking and the use of naked lights should be prohibited during loading and unloading and on entry to the cargo space (s) at any other time.	1386	
1387	WOOL WASTE, WET	4.2	-	III	117	0	E1	P410	-	-	-	-	-	F-A, S-J	Category A.	Liable to ignite spontaneously in air according to moisture content.	1387	
1389	ALKALI METAL AMALGAM, LIQUID	4.3	-	I	182	0	E0	P402	PP31	-	-	-	-	F-G, S-N	Category D. "Separated from" acids.	Silvery liquid, consisting of metal alloyed with mercury. Reacts with moisture, water or acids, evolving hydrogen, a flammable gas. When heated, evolves toxic vapours.	1389	
1390	ALKALI METAL AMIDE	4.3	-	II	182	500 g	E2	P410	PP31	IBC07	B2	T3	TP33	F-G, S-O	Category E. Clear of living quarters. "Separated from" acids.	Small crystals. Decomposes in contact with water or acids, evolving ammonia vapour and producing highly caustic alkaline solutions.	1390	
1391	ALKALI METAL DISPERSION or ALKALINE EARTH METAL DISPERSION	4.3	-	I	182	0	E0	P402	PP31	-	-	-	-	F-G, S-N	Category D. "Separated from" acids.	Finely divided alkali or alkaline earth metal, suspended in a liquid. Reacts violently with moisture, water or acids, evolving hydrogen, which may be ignited by the heat of the reaction.	1391	
1392	ALKALINE EARTH METAL AMALGAM, LIQUID	4.3	-	I	183	0	E0	P402	PP31	-	-	-	-	F-G, S-N	Category D. "Separated from" acids.	Consists of metal alloyed with mercury. Contains 2% to 10% alkaline earth metals and may contain up to 98% mercury. Reacts with moisture, water or acids, evolving hydrogen, a flammable gas. When heated, evolves toxic vapours.	1392	
1393	ALKALINE EARTH METAL ALLOY, N.O.S.	4.3	-	II	183	500 g	E2	P410	PP31	IBC07	B2	T3	TP33	F-G, S-N	Category E. "Separated from" acids.	When containing a substantial proportion of alkaline earth metals, readily decomposed by water and reacts violently with acids, evolving hydrogen, which may be ignited by the heat of the reaction.	1393	
1394	ALUMINIUM CARBIDE	4.3	-	II	-	500 g	E2	P410	PP31	IBC07	B2	T3	TP33	F-G, S-N	Category A. "Separated from" acids.	Yellow crystals or powder. In contact with water, rapidly evolves methane, a flammable gas. Reacts violently with acids.	1394	
1395	ALUMINIUM FERROSILICON POWDER	4.3	6.1	II	932	500 g	E2	P410	-	IBC05	B2	T3	TP33	F-G, S-N	Category A. Only to be loaded under dry weather conditions. Unlikely to ignite spontaneously in ventilated space. Clear of living quarters. "Away from" liquid halogenated hydrocarbons. "Separated from" acids and alkalis.	In contact with water, caustic alkalis or acids, evolves hydrogen, a flammable gas. Impurities may, under similar circumstances, produce phosphine and arsine, which are highly toxic gases.	1395	
1396	ALUMINIUM POWDER, UNCOATED	4.3	-	II	-	500 g	E2	P410	PM40	IBC07	B2	T3	TP33	F-G, S-O	Category A. "Away from" liquid halogenated hydrocarbons. "Separated from" acids and alkalis.	In contact with water, caustic alkalis or acids, evolves hydrogen, a flammable gas. May be ignited by naked lights, causing explosion. May explode when in contact with oxidizing substances. Reacts with liquid halogenated hydrocarbons.	1396	

**TSFS 2015:66  
Bilaga 1**

UN No. (1)	PSN (2)	Class No. (3)	Subsidiary Risk(s) (4)	Packing Group (5)	Special Provisions (6)	Limited quantities (7a)	Excepted quantities (7b)	Packing		IBC Provisions (11)	Portable tanks and bulk containers		UN No. (16)	Properties and Observations (17)	1396	
								Instruc-tions (8)	Instruc-tions (9)		Tank instructions (15)	Provisions (14)				EMS (15)
1396	ALUMINIUM POWDER, UNCOATED	4.3	-	III	223	1 kg	E1	P410	-	IBC08	B4	TI	TP33	F-C, S-O	Category A. "Away from" liquid separated from acids and alkalis. See entry above.	1396
1397	ALUMINIUM PHOSPHIDE	4.3	6.1	I	-	0	ED	P403	PP31	-	-	-	-	F-C, S-N	Category E. Under deck in a mechanically ventilated space. Clear of living quarters. "Separated from" acids.	1397
1398	ALUMINIUM SILICON POWDER, UNCOATED	4.3	-	III	37 223 952	1 kg	E1	P410	-	IBC08	B4	TI BK2	TP33	F-C, S-N	Category A. Only to be loaded under deck in a mechanically ventilated space. Clear of living quarters. "Away from" liquid halogenated hydrocarbons. Separated from acids and alkalis.	1398
1400	BARIUM	4.3	-	II	-	500 g	E2	P410	PP31 PM40	IBC07	B2	T3	TP33	F-C, S-O	Category E. "Separated from" acids.	1400
1401	CALCIUM	4.3	-	II	-	500 g	E2	P410	PP31 PM40	IBC07	B2	T3	TP33	F-C, S-O	Category E. "Separated from" acids. Reacts violently with water and reacts violently with acids, evolving hydrogen, which may be ignited by the heat of the reaction. Harmful if swallowed or by dust inhalation.	1401
1402	CALCIUM CARBIDE	4.3	-	I	951	0	ED	P403	PP31	IBC04	B1	BK2	-	F-C, S-N	Category B. "Separated from" acids. Solid. In contact with water, rapidly evolves acetylene, a highly flammable gas, which may be ignited by the heat of the reaction. Acetylene forms highly explosive compounds with salts of some heavy metals. Reacts violently with acids.	1402
1402	CALCIUM CARBIDE	4.3	-	II	951	500 g	E2	P410	PM40	IBC07	B2	T3 BK2	TP33	F-C, S-N	Category B. "Separated from" acids. See entry above.	1402
1403	CALCIUM CYANAMIDE with more than 0.1% calcium carbide	4.3	-	III	38 954	1 kg	E1	P410	-	IBC08	B4	TI	TP33	F-C, S-N	Category A. "Separated from" acids. Powder or granules. Contains calcium carbide as an impurity. In contact with water, evolves ammonia and acetylene, which is a highly flammable gas. Reacts vigorously with acids.	1403
1404	CALCIUM HYDRIDE	4.3	-	I	-	0	ED	P403	PP31	-	-	-	-	F-C, S-O	Category E. "Separated from" acids. Solid. In contact with water, acids or moisture, evolves hydrogen, which may be ignited by the heat of the reaction.	1404
1405	CALCIUM SILICIDE	4.3	-	II	952	500 g	E2	P410	PP31	IBC07	B2	T3	TP33	F-C, S-N	Category B. Only to be loaded under dry weather conditions. Under deck in a mechanically ventilated space. Separated from" acids.	1405
1405	CALCIUM SILICIDE	4.3	-	III	223 952	1 kg	E1	P410	PP31 PM40	IBC08	B4	TI	TP33	F-C, S-N	Category B. Only to be loaded under dry weather conditions. Under deck in a mechanically ventilated space. Separated from" acids.	1405
1407	CASIUM	4.3	-	I	-	0	ED	P403	PP31	IBC04	B1	-	-	F-C, S-N	Category D. "Separated from" acids. Evolves hydrogen, which may be ignited by the heat of the reaction. Highly reactive, sometimes with explosive effect.	1407
1408	FERROSILICON with 30% or more but less than 90% silicon	4.3	6.1	III	39 223 952	1 kg	E1	P003	PP20	IBC08	B4 B6	TI BK2	TP33	F-C, S-N	Category A. Only to be loaded under dry weather conditions. Keep as dry as reasonably practicable. Under deck in a mechanically ventilated space. Clear of living quarters. "Separated from" acids and alkalis.	1408
1409	METAL HYDRIDES, WATER-REACTIVE, N.O.S.	4.3	-	I	274	0	ED	P403	PP31	-	-	-	-	F-C, S-L	Category D. "Separated from" acids. Solids. React with water, moisture or acids, evolving hydrogen, which may be ignited by the heat of the reaction.	1409
1409	METAL HYDRIDES, WATER-REACTIVE, N.O.S.	4.3	-	II	274	500 g	E2	P410	PM40	IBC04	-	T3	TP33	F-C, S-L	Category D. "Separated from" acids. See entry above.	1409

UN No. (1)	PSN (2)	Class No. (3)	Subsidiary Risk(s) (4)	Packing Group (5)	Special Provisions (6)	Limited quantities (7a)	Excepted quantities (7b)	Packing		IBC	
								Instruc-tions (8)	Provisions (9)	Instruc-tions (10)	Provisions (11)
	3.1.2	2.0	2.0	2.0	1.3	3.3	3.4	3.5	4.1, 4	4.1, 4	4.1, 4

Portable tanks and bulk containers		EMs (15)	Stowage and Segregation (16)	Properties and Observations (17)
Tank instructions (15)	Provisions (14)			
4.2.5 4.3	4.2.5	54.5.2 7.8	7.1 to 7.7	

1410 LITHIUM ALUMINUM HYDRIDE	4.3	-	I	-	0	ED	P403	PP31	-	-	-	F-C, S-M	Category E. "Separated from" acids.	White powder. In contact with water, acids or moisture, evolves hydrogen, which may be ignited by the heat of the reaction.	1410
1411 LITHIUM ALUMINUM HYDRIDE, ETHERAL	4.3	3	I	-	0	ED	P402	-	-	-	-	F-G, S-M	Category D. Clear of living quarters.	Clear, colourless solution of lithium aluminium hydride in ether. Reacts readily with water, evolving hydrogen, a flammable gas. Evaporates readily to leave a residue which is easily ignited by a spark or friction.	1411
1413 LITHIUM BOROHYDRIDE	4.3	-	I	-	0	ED	P403	PP31	-	-	-	F-G, S-O	Category E. "Separated from" acids.	Crystalline, hygroscopic solid. In contact with water, acids and moisture evolves hydrogen, which may be ignited by the heat of the reaction.	1413
1414 LITHIUM HYDRIDE	4.3	-	I	-	0	ED	P403	PP31	-	-	-	F-G, S-N	Category E. "Separated from" acids.	Solid. In contact with water, acids or moisture, evolves hydrogen, which may be ignited by the heat of the reaction.	1414
1415 LITHIUM	4.3	-	I	-	0	ED	P403	PP31	IBC04	B1	-	F-G, S-N	Category E. "Separated from" acids.	White, ductile, soft metal. Floats on water. Readily decomposes in water and reacts violently with acids, evolving hydrogen, which may be ignited by the heat of the reaction. For fire-fighting purposes, dry lithium chloride powder, dry sodium chloride or graphite powder should be carried on board when this substance is transported.	1415
1417 LITHIUM SILICON	4.3	-	II	-	500 g	E2	P410	PP31 PH40	IBC07	B2	-	F-G, S-N	Category A. Only to be loaded under dry weather conditions. Separated from acids, mechanically ventilated space.	Shiny lumps, crystals or powder, with sharp irritating odour. Reacts readily with water, evolving hydrogen and silane, flammable gases. Enough heat may be generated to ignite the gas mixture in air.	1417
1418 MAGNESIUM POWDER or MAGNESIUM ALLOYS POWDER	4.3	4.2	I	-	0	ED	P403	PP31	-	-	-	F-G, S-O	Category A. "Away from" liquid halogenated hydrocarbons.	In contact with moisture, water or acids, evolves hydrogen, a flammable gas. Magnesium dust is easily ignited, causing explosion. May explode if heated. In contact with water, evolves hydrogen. Dry sodium chloride or lithium chloride powder, dry sodium chloride or graphite powder should be carried on board when this substance is transported. Reacts with liquid halogenated hydrocarbons.	1418
1418 MAGNESIUM POWDER or MAGNESIUM ALLOYS POWDER	4.3	4.2	II	-	0	E2	P410	PH40	IBC05	B2	-	F-G, S-O	Category A. "Away from" liquid halogenated hydrocarbons.	See entry above.	1418
1418 MAGNESIUM POWDER or MAGNESIUM ALLOYS POWDER	4.3	4.2	III	223	0	E1	P410	-	IBC08	B4	-	F-G, S-O	Category A. "Away from" liquid halogenated hydrocarbons.	See entry above.	1418
1419 MAGNESIUM ALUMINIUM PHOSPHIDE	4.3	6.1	I	-	0	ED	P403	PP31	-	-	-	F-G, S-N	Category E. Under deck in a mechanically ventilated space. Clear of living quarters. "Separated from" acids.	Solid. Reacts with acids or decomposes slowly in contact with water or damp air, evolving phosphine, a spontaneously flammable and highly toxic gas. Reacts violently with oxidizing substances. Toxic if swallowed, by skin contact or by inhalation.	1419
1420 POTASSIUM METAL ALLOYS, LIQUID	4.3	-	I	-	0	ED	P402	PP31	-	-	-	F-G, S-L	Category D. "Separated from" acids.	Soft, silvery metal liquid. Floats on water. Reacts violently with moisture, water or acids, evolving hydrogen, which may be ignited by the heat of the reaction. Highly reactive, sometimes with explosive effect.	1420
1421 ALKALI METAL ALLOY, LIQUID, N.O.S.	4.3	-	I	182	0	ED	P402	PP31	-	-	-	F-G, S-L	Category D. "Separated from" acids.	Flows like mercury at ordinary temperatures. Not volatile. Reacts violently with moisture, water or acids, evolving hydrogen, a flammable gas, and developing considerable heat which may ignite the gas.	1421
1422 POTASSIUM SODIUM ALLOYS, LIQUID	4.3	-	I	-	0	ED	P402	PP31	-	-	-	F-G, S-L	Category D. "Separated from" acids.	Soft, silvery metal liquid. Floats on water. Reacts violently with moisture, water or acids, evolving hydrogen, which may be ignited by the heat of the reaction. Highly reactive, sometimes with explosive effect.	1422
1423 RUBIDIUM	4.3	-	I	-	0	ED	P403	PP31	IBC04	B1	-	F-G, S-N	Category D. "Separated from" acids.	Silvery-white, ductile, soft metal. Melting point: 39°C. Floats on water. Reacts violently with moisture, water or acids, evolving hydrogen, which may be ignited by the heat of the reaction. Highly reactive, sometimes with explosive effect.	1423
1426 SODIUM BOROHYDRIDE	4.3	-	I	-	0	ED	P403	PP31	-	-	-	F-G, S-O	Category E. "Separated from" acids.	Crystalline powder. In contact with water, acids or moisture, evolves hydrogen, which may be ignited by the heat of the reaction.	1426
1427 SODIUM HYDRIDE	4.3	-	I	-	0	ED	P403	PP31	-	-	-	F-G, S-O	Category E. "Separated from" acids.	White powder. In contact with water, acids or moisture, evolves hydrogen, which may be ignited by the heat of the reaction.	1427

**TSFS 2015:66**  
**Bilaga 1**

UN No. (1)	PSN (2)	Class or Div (3)	Subsidiary Risk(s) (4)	Packing Group (5)	Special Provisions (6)	Limited quantities (7a)	Excepted quantities (7b)	Packing		IBC		Tank instructions (15)	Provisions (14)	EMs (15)	Stowage and Segregation (16)	Properties and Observations (17)	UN No. (18)
								Instruc-tions (8)	Provisions (9)	Instruc-tions (10)	Provisions (11)						
1428	SODIUM	4.3	-	I	-	0	E0	P403	PP31	IBC04	B1	T9	TP33	F-G, S-N	Category D. "Separated from" acids.	White, ductile, soft metal. Flights on water. Reacts violently with moisture, especially in the heat of the reaction. Highly reactive, sometimes with explosive effect.	1428
1431	SODIUM METHYLATE	4.2	8	II	-	0	E2	P410	PP31	IBC05	B2	T3	TP33	F-A, S-L	Category B.	White, amorphous, fine-flaking, hygroscopic powder. Decomposed by water from which a flammable gas may be released by the heat of the reaction. Causes burns to skin, eyes and mucous membranes.	1431
1432	SODIUM PHOSPHIDE	4.3	6.1	I	-	0	E0	P403	PP31	-	-	-	-	F-G, S-N	Category E. Under deck in a mechanically ventilated space. Clear of living quarters. "Separated from" acids.	Solid. Reacts with acids or decomposes slowly in contact with water or damp air, evolving phosphine, a spontaneously flammable and highly toxic gas. Reacts violently with oxidizing substances. Toxic if swallowed; by skin contact or by inhalation.	1432
1433	STANNIC PHOSPHIDE	4.3	6.1	I	-	0	E0	P403	PP31	-	-	-	-	F-G, S-N	Category E. Under deck in a mechanically ventilated space. Clear of living quarters. "Separated from" acids.	Silver-white solid. Reacts with acids or decomposes slowly in contact with water or damp air, evolving phosphine, a spontaneously flammable and highly toxic gas. Reacts violently with oxidizing substances. Toxic if swallowed; by skin contact or by inhalation.	1433
1435	ZINC ASHES	4.3	-	III	223	1 kg	E1	P002	-	IBC08	B4	T1 BK2	TP33	F-G, S-O	Category A.	In contact with moisture or water, liable to evolve dangerous gases, including hydrogen, a flammable gas.	1435
1436	ZINC POWDER or ZINC DUST	4.3	4.2	I	-	0	E0	P403	-	-	-	-	-	F-G, S-O	Category A. "Separated from" acids and alkalis.	In contact with water, alkalis or acids, evolves hydrogen, a flammable gas. Zinc dust is easily ignited, causing explosion. May explode when in contact with oxidizing substances.	1436
1436	ZINC POWDER or ZINC DUST	4.3	4.2	II	-	0	E2	P410	PM40	IBC07	B2	T3	TP33	F-G, S-O	Category A. "Separated from" acids and alkalis.	See entry above.	1436
1436	ZINC POWDER or ZINC DUST	4.3	4.2	III	223	0	E1	P410	-	IBC08	B4	T1	TP33	F-G, S-O	Category A. "Separated from" acids and alkalis.	See entry above.	1436
1437	ZIRCONIUM HYDRIDE	4.1	-	II	-	1 kg	E2	P410	PP31 PM40	IBC04	-	T3	TP33	F-A, S-C	Category E.	Black coloured powder.	1437
1438	ALUMINIUM NITRATE	5.1	-	III	-	5 kg	E1	P002 LP02	-	IBC08	B3	T1 BK2	TP33	F-A, S-Q	Category A.	Colourless or white crystals. Deliquescent. Soluble in water. Slightly corrosive. Mixtures with combustible material are readily ignited and may burn fiercely. Harmful if swallowed.	1438
1439	AMMONIUM DICHROMATE	5.1	-	II	-	1 kg	E2	P002	-	IBC08	B2 B4	T3	TP33	F-H, S-Q	Category A. "Separated from" strong acids.	Orange needles. Soluble in water. Mixtures with combustible material are readily ignited and may burn fiercely. May ignite spontaneously in contact with strong acids. Harmful if swallowed.	1439
1442	AMMONIUM PERCHLORATE	5.1	-	II	152	1 kg	E2	P002	-	IBC06	B2	T3	TP33	F-H, S-Q	Category E. "Separated from" cyanides and hydrogen peroxide.	White crystals or powder. Soluble in water. When heated, decomposes readily, even with explosion, evolving toxic fumes. Forms highly explosive mixtures with combustible material or powdered metals. These mixtures are sensitive to friction and are liable to ignite.	1442
1444	AMMONIUM PERSULPHATE	5.1	-	III	-	5 kg	E1	P002 LP02	-	IBC08	B3	T1	TP33	F-A, S-Q	Category A.	White crystals or powder. Soluble in water. Mixtures with combustible material are sensitive to friction and are liable to ignite.	1444
1445	BARIUM CHLORATE, SOLID	5.1	6.1	II	-	1 kg	E2	P002	-	IBC06	B2	T3	TP33	F-H, S-Q	Category A. "Separated from" cyanides and hydrogen peroxide.	Colourless crystals or powder. Reacts vigorously with sulphuric acid. Forms highly explosive mixtures with combustible material, powdered metals or ammonium compounds. These mixtures are sensitive to friction and are liable to ignite. When involved in a fire may cause an explosion. Toxic if swallowed; by skin contact or by dust inhalation.	1445
1446	BARIUM NITRATE	5.1	6.1	II	-	1 kg	E2	P002	-	IBC08	B2 B4	T3 BK2	TP33	F-A, S-Q	Category A.	White crystals. Mixtures with combustible material are readily ignited and may burn fiercely. Toxic if swallowed; by skin contact or by dust inhalation.	1446

UN No. (1)	PSN (2)	Class or Div (5)	Subsidiary Risk(s) (4)	Packing Group (3)	Special Provisions (6)	Limited quantities (7a)	Excepted quantities (7b)	Packing			IBC	
								Instruc-tions (8)	Provisions (9)	Instruc-tions (10)	Provisions (11)	
3.1.2		2.0	2.0	2.0	1.3	3.3	3.4	3.5	4.1, 4	4.1, 4	4.1, 4	

Tank instructions (15)	Provisi- ons (14)	EMs (15)	Stowage and Segregation (16)	UN No. (18)

Portable tanks and bulk containers	TP33	F-H, S-Q	Category A. "Separated from" ammonium compounds and cyanides.	White crystals or powder, soluble in water. Reacts vigorously with sulphuric acid and hydrogen peroxide. Reacts fiercely with cyanides when heated or by friction. These mixtures are sensitive to friction and are liable to ignite. When involved in a fire may cause an explosion. Toxic if swallowed, by skin contact or by dust inhalation.
T3	TP33	F-H, S-Q	Category D. "Separated from" ammonium compounds, cyanides and peroxides.	Brownish-violet crystals. Soluble in water. Reacts vigorously with sulphuric acid and hydrogen peroxide. Reacts fiercely with cyanides when heated or by friction. These mixtures are sensitive to friction and are liable to ignite. When involved in a fire may cause an explosion. Toxic if swallowed, by skin contact or by dust inhalation.

1447	BARIUM PERCHLORATE, SOLID	5.1	6.1	II	-	1 kg	E2	P002	-	IBC06	B2	1447
1448	BARIUM PERSULFATE	5.1	6.1	II	-	1 kg	E2	P002	-	IBC06	B2	1448

1449	BARIUM PEROXIDE	5.1	6.1	II	-	1 kg	E2	P002	-	IBC06	B2	1449
1450	BROMATES, INORGANIC, N.O.S.	5.1	-	II	224 350	1 kg	E2	P002	-	IBC08	B2 B4	1450

1451	CESIUM NITRATE	5.1	-	III	-	5 kg	E1	P002 LP02	-	IBC08	B3	1451
1452	CALCIUM CHLORIDE	5.1	-	II	-	1 kg	E2	P002	-	IBC08	B2 B4	1452

1453	CALCIUM CHLORIDE	5.1	-	II	-	1 kg	E2	P002	-	IBC08	B2 B4	1453
1454	CALCIUM NITRATE	5.1	-	III	208 367	5 kg	E1	P002 LP02	-	IBC08	B3	1454

1455	CALCIUM PERCHLORATE	5.1	-	II	-	1 kg	E2	P002	-	IBC06	B2	1455
1456	CALCIUM PERSULFATE	5.1	-	II	-	1 kg	E2	P002	-	IBC06	B2	1456

1457	CALCIUM PEROXIDE	5.1	-	II	-	1 kg	E2	P002	-	IBC06	B2	1457
1458	CHLORATE AND BORATE MIXTURE	5.1	-	II	-	1 kg	E2	P002	-	IBC08	B2 B4	1458

1458	CHLORATE AND BORATE MIXTURE	5.1	-	III	223	5 kg	E1	P002 LP02	-	IBC08	B3	1458
------	-----------------------------	-----	---	-----	-----	------	----	--------------	---	-------	----	------

**TSFS 2015:66  
Bilaga 1**

UN No. (1)	PSN (2)	Class No. or Div. (3)	Subsidiary Risk(s) (4)	Packing Group (5)	Special Provisions (6)	Limited quantities (7a)	Excepted quantities (7b)	Packing		IBC		Provisional instructions (15)	Tank instructions (16)	EHS (15)	Stowage and Segregation (16)	Properties and Observations (17)	UN No. (18)
								Class (5)	Div. (6)	Instruc-tions (8)	Provisions (9)						
	3.1.2	2.0	2.0	2.0, 1.3	3.3	3.4	3.5	4.1, 4	4.1, 4	4.1, 4		4.2, 5 4.3	7.1 to 7.7				
1459	CHLORATE AND MAGNESIUM CHLORIDE MIXTURE, SOLID	5.1	-	II	-	1 kg	E2	P002	-	IBC08	B2 B4	T3	TP33	F-H, S-Q	Category A. "Separated from" ammonium compounds and cyanides.	Deliquescent solid. Reacts vigorously with sulphuric acid. Reacts fiercely with cyanides with combustible material, powdered metals or ammonium compounds. These mixtures are sensitive to friction and are liable to ignite. When involved in a fire, they may cause an explosion. See entry above.	1459
1459	CHLORATE AND MAGNESIUM CHLORIDE MIXTURE, SOLID	5.1	-	III	223	5 kg	E1	P002 LP02	-	IBC08	B3	T1	TP33	F-H, S-Q	Category A. "Separated from" ammonium compounds and cyanides.	See entry above.	1459
1461	CHLORATES, INORGANIC, N.O.S.	5.1	-	II	274 351	1 kg	E2	P002	-	IBC06	B2	T3	TP33	F-H, S-Q	Category A. "Separated from" ammonium compounds and cyanides.	Solids. React vigorously with sulphuric acid. React fiercely with cyanides when heated or by friction. May form explosive mixtures with combustible material. These mixtures are sensitive to friction and are liable to ignite. When involved in a fire, they may cause an explosion. Transport of ammonium chlorate and mixtures of a chlorate with an ammonium salt is prohibited.	1461
1462	CHLORITES, INORGANIC, N.O.S.	5.1	-	II	274 352	1 kg	E2	P002	-	IBC06	B2	T3	TP33	F-H, S-Q	Category A. "Separated from" ammonium compounds and cyanides.	Solids. React vigorously with sulphuric acid. React fiercely with cyanides when heated or by friction. May form explosive mixtures with combustible material, powdered metals or ammonium compounds. These mixtures are sensitive to friction and are liable to ignite. Transport of ammonium chlorite and mixtures of a chlorite with an ammonium salt is prohibited.	1462
1463	CHROMIUM TRIOXIDE, ANHYDROUS	5.1	6.1 8	II	-	1 kg	E2	P002	PP31	IBC08	B2 B4	T3	TP33	F-A, S-Q	Category A. "Separated from" class 5.1 but "Separated from" classes 4.1 and 7.	Dark-purplish red deliquescent crystals. Soluble in water. Mixtures with combustible material may ignite spontaneously and may even explode. In the presence of moisture, corrosive to most metals. Causes burns to skin, eyes and mucous membranes.	1463
1465	DIDYMIUM NITRATE	5.1	-	III	-	5 kg	E1	P002 LP02	-	IBC08	B3	T1	TP33	F-A, S-Q	Category A.	Hygroscopic solid. Mixture of neodymium nitrate and praseodymium nitrate. Mixtures with combustible material are readily ignited and may burn fiercely. Harmful if swallowed.	1465
1466	FERRIC NITRATE	5.1	-	III	-	5 kg	E1	P002 LP02	-	IBC08	B3	T1	TP33	F-A, S-Q	Category A.	Violet deliquescent crystals. Soluble in water. Melting point: 47°C. Mixtures with combustible material are readily ignited and may burn fiercely. Solutions in water are slightly corrosive to most metals. Harmful if swallowed.	1466
1467	GUANIDINE NITRATE	5.1	-	III	-	5 kg	E1	P002 LP02	-	IBC08	B3	T1	TP33	F-A, S-Q	Category A. "Separated from" chlorates.	White granules. Soluble in water. Mixtures with combustible material are sensitive to friction and are liable to ignite. NITROGUANIDINE is a different substance.	1467
1469	LEAD NITRATE	5.1	6.1 P	II	-	1 kg	E2	P002	-	IBC08	B2 B4	T3 BKG	TP33	F-A, S-Q	Category A.	White crystals. Soluble in water. Mixtures with combustible material are readily ignited and may burn fiercely. Toxic if swallowed, by skin contact or by dust inhalation.	1469
1470	LEAD PERCHLORATE, SOLID	5.1	6.1 P	II	-	1 kg	E2	P002	-	IBC06	B2	T3	TP33	F-H, S-Q	Category A. "Separated from" ammonium compounds and cyanides.	White crystals or powder. Soluble in water. Reacts vigorously with sulphuric acid. Reacts fiercely with cyanides when heated or by friction. Mixtures with combustible material are readily ignited and may burn fiercely. These mixtures are sensitive to friction and are liable to ignite. When involved in a fire may cause an explosion. Toxic if swallowed, by skin contact or by dust inhalation.	1470
1471	LITHIUM HYPOCHLORITE, DRY or LITHIUM HYPOCHLORITE MIXTURE	5.1	-	II	-	1 kg	E2	P002	-	IBC08	B2 B4	T3	TP33	F-H, S-Q	Category A. Ventilation may be required. The possible need to open hatches. In case of fire to apply water in an emergency, and the consequent risk to the stability of the ship through flooding of the cargo spaces, shall be taken into account. "Separated from" ammonium compounds, acids, cyanides, hydrogen peroxide and liquid organic peroxides. Protected from sources of heat.	White powder with pungent odour. Soluble in water. Critical ambient temperature of decomposition may be as low as 60°C. May cause fire in contact with organic material or ammonium compounds. Reacts with acids to form toxic gases. May be sensitive to moisture. Corrosive to most metals. Dust irritates mucous membranes.	1471

UN No. (1)	PSN (2)	Class or Div (3)	Subsidiary Risk(s) (4)	Packing Group (5)	Special Provisions (6)	Limited quantities (7a)	Excepted quantities (7b)	Packing		IBC		Tank instructions (15)	Provisions (16)	EMs (15)	Stowage and Segregation (16)	Properties and Observations (17)	UN No. (18)
								Institutions (8)	Provisions (9)	Institutions (10)	Provisions (11)						
1471	LITHIUM HYPOCHLORITE, DRY or LITHIUM HYPOCHLORITE MIXTURE	5.1	-	III	223	5 kg	E1	P002 LP02	-	IBC08	B3	TI	TP33	F-H, - S-Q	See entry above.	1471	
1472	LITHIUM PEROXIDE	5.1	-	II	-	1 kg	E2	P002	-	IBC06	B2	T3	TP33	F-G, S-Q	White powder. Soluble in water. Solution in water is an alkaline corrosive liquid. Particularly if wetted with small quantities of water, a mixture with combustible material may ignite following impact or friction. When heated in a fire, or in contact with water or acids, decomposes, evolving oxygen.	1472	
1473	MAGNESIUM BROMATE	5.1	-	II	-	1 kg	E2	P002	-	IBC08	B2 B4	T3	TP33	F-H, S-Q	White deliquescent crystals or crystalline powder. Soluble in water. Reacts vigorously with sulphuric acid. Reacts fiercely with cyanides when heated or by friction. May form explosive mixtures with combustible material, powdered metals or ammonium compounds. These mixtures are sensitive to friction and are liable to ignite. When involved in a fire, may cause an explosion.	1473	
1474	MAGNESIUM NITRATE	5.1	-	III	332 967	5 kg	E1	P002 LP02	-	IBC08	B3	TI BK2, BK3	TP33	F-A, S-Q	White deliquescent crystals, soluble in water. Mixtures with combustible material are readily ignited and may burn fiercely. Harmful if swallowed.	1474	
1475	MAGNESIUM PERCHLORATE	5.1	-	II	-	1 kg	E2	P002	-	IBC06	B2	T3	TP33	F-H, S-Q	White crystals or powder. Reacts vigorously with sulphuric acid. Reacts with mixtures with combustible material, powdered metals or ammonium compounds. These mixtures are sensitive to friction and are liable to ignite. When involved in a fire, may cause an explosion.	1475	
1476	MAGNESIUM PEROXIDE	5.1	-	II	-	1 kg	E2	P002	-	IBC06	B2	T3	TP33	F-G, S-Q	White powder. Particularly if wetted with small quantities of water, a mixture with combustible material may ignite following impact or friction. When involved in a fire, or in contact with water or acids, decomposes, evolving oxygen. Harmful if swallowed.	1476	
1477	NITRATES, INORGANIC, N.O.S.	5.1	-	II	-	1 kg	E2	P002	-	IBC08	B2 B4	T3	TP33	F-A, S-Q	Solids. Solid mixtures with combustible material are readily ignited and may burn fiercely. Harmful if swallowed.	1477	
1477	NITRATES, INORGANIC, N.O.S.	5.1	-	III	223	5 kg	E1	P002 LP02	-	IBC08	B3	TI	TP33	F-A, S-Q	See entry above.	1477	
1479	OXIDIZING SOLID, N.O.S.	5.1	-	I	274 500	0	E0	P503	-	IBC05	B1	-	-	F-A, S-Q	-	-	1479
1479	OXIDIZING SOLID, N.O.S.	5.1	-	II	274 500	1 kg	E2	P002	-	IBC08	B2 B4	T3	TP33	F-A, S-Q	-	-	1479
1479	OXIDIZING SOLID, N.O.S.	5.1	-	III	223 500	5 kg	E1	P002 LP02	-	IBC08	B3	TI	TP33	F-A, S-Q	-	-	1479
1481	PERCHLORATES, INORGANIC, N.O.S.	5.1	-	II	-	1 kg	E2	P002	-	IBC06	B2	T3	TP33	F-H, S-Q	Solids. React vigorously with sulphuric acid. React fiercely with cyanides when heated or by friction. May form explosive mixtures with combustible material. These mixtures are sensitive to friction and are liable to ignite. When involved in a fire, may cause an explosion.	1481	
1481	PERCHLORATES, INORGANIC, N.O.S.	5.1	-	III	223	5 kg	E1	P002 LP02	-	IBC08	B3	TI	TP33	F-H, S-Q	See entry above.	1481	

**TSFS 2015:66**  
**Bilaga 1**

UN No. (1)	PSN (2)	Class No. (3)	Subsidiary Risk(s) (4)	Packing Group (5)	Special Provisions (6)	Limited quantities (7a)	Expedit quantities (7b)	Packing		IBC		Tank instructions (15)	Provisions (14)	EMS (15)	Stowage and Segregation (16)	Properties and Observations (17)	UN No. (18)
								Instruc-tions (8)	Provisions (9)	Instruc-tions (10)	Provisions (11)						
	3.1.2	2.0	2.0	2.0, 1.3	3.3	3.4	3.5	4.1, 4	4.1, 4	4.1, 4		4.2, 5	4.2, 5	5.4, 5.2	7.1 to 7.7		
1482	PERMANGANATES, INORGANIC, N.O.S.	5.1	-	II	274 353	1 kg	E2	P002	-	IBC06	B2	T3	TP33	F-H, S-Q	Category D. "Separated from" ammonium compounds, cyanides and peroxides.	Solids. Reacts vigorously with sulphuric acid. Reacts fiercely with cyanides, metal, powdered metals or ammonium compounds. These mixtures are sensitive to friction and are liable to ignite. When involved in a fire, may cause an explosion. Transport of ammonium permanganate and mixtures of a permanganate with an ammonium salt is prohibited.	1482
1482	PERMANGANATES, INORGANIC, N.O.S.	5.1	-	III	223 274 353	5 kg	E1	P002	-	IBC08	B3	T1	TP33	F-H, S-Q	Category D. "Separated from" ammonium compounds, cyanides and peroxides.	See entry above.	1482
1483	PEROXIDES, INORGANIC, N.O.S.	5.1	-	II	-	1 kg	E2	P002	-	IBC06	B2	T3	TP33	F-G, S-Q	Category A. Keep as dry as reasonably practicable. "Separated from" permanganates, acids and class 4.1.	Particularly if wetted with small quantities of water, a mixture with combustible material may ignite following impact or friction. When involved in a fire, or in contact with water or acids, decomposes, evolving oxygen.	1483
1483	PEROXIDES, INORGANIC, N.O.S.	5.1	-	III	223	5 kg	E1	P002 LP02	-	IBC08	B3	T1	TP33	F-G, S-Q	Category A. Keep as dry as reasonably practicable. "Separated from" permanganates, acids and class 4.1.	See entry above.	1483
1484	POTASSIUM BROMATE	5.1	-	II	-	1 kg	E2	P002	-	IBC08	B2 B4	T3	TP33	F-H, S-Q	Category A. "Separated from" ammonium compounds and cyanides.	White crystals or powder. Soluble in water. Reacts vigorously with sulphuric acid. Reacts fiercely with cyanides when heated or by friction. May form explosive mixtures with combustible material. Powder of metals and alloys is sensitive to friction and are liable to ignite. When involved in a fire, may cause an explosion.	1484
1485	POTASSIUM CHLORATE	5.1	-	II	-	1 kg	E2	P002	-	IBC08	B2 B4	T3 BK2	TP33	F-H, S-Q	Category A. "Separated from" ammonium compounds and cyanides.	White crystals or powder. Soluble in water. Reacts vigorously with sulphuric acid. Reacts fiercely with cyanides when heated or by friction. May form explosive mixtures with combustible material. Powder of metals and alloys is sensitive to friction and are liable to ignite. When involved in a fire, may cause an explosion.	1485
1486	POTASSIUM NITRATE	5.1	-	III	964 967	5 kg	E1	P002 LP02	-	IBC08	B3	T1 BK2 BK3	TP33	F-A, S-Q	Category A. When transported in BK3 bulk container, see 7.6.2.12 and 7.7.3.9.	White crystals or powder. Soluble in water. Mixtures with combustible material are readily ignited and may burn fiercely. Harmful if swallowed.	1486
1487	POTASSIUM NITRATE AND SODIUM NITRITE MIXTURE	5.1	-	II	-	1 kg	E2	P002	-	IBC08	B2 B4	T3	TP33	F-A, S-Q	Category A. "Separated from" ammonium compounds and cyanides.	Deliquescent solid. Soluble in water. May cause fire in contact with organic material such as wood, cotton or straw. Mixtures with ammonium compounds or cyanides may explode. Harmful if swallowed. May be shipped in the form of fused solid block or lumps.	1487
1488	POTASSIUM NITRITE	5.1	-	II	-	1 kg	E2	P002	-	IBC08	B2 B4	T3	TP33	F-A, S-Q	Category A. "Separated from" ammonium compounds and cyanides.	White or slightly yellowish deliquescent crystals or sticks. Soluble in water. Mixtures with combustible material are readily ignited and may burn fiercely. Mixtures with ammonium compounds or cyanides may explode. Harmful if swallowed.	1488
1489	POTASSIUM PERCHLORATE	5.1	-	II	-	1 kg	E2	P002	-	IBC06	B2	T3	TP33	F-H, S-Q	Category A. "Separated from" ammonium compounds and cyanides.	White crystals or powder, soluble in water. Reacts vigorously with sulphuric acid. Reacts fiercely with cyanides when heated or by friction. May form explosive mixtures with combustible material. Powder of metals and alloys is sensitive to friction and are liable to ignite.	1489
1490	POTASSIUM PERMANGANATE	5.1	-	II	-	1 kg	E2	P002	-	IBC08	B2 B4	T3	TP33	F-H, S-Q	Category D. "Separated from" ammonium compounds, cyanides and peroxides.	Dark purple crystals or powder. Soluble in water. Reacts vigorously with sulphuric acid and hydrogen peroxide. Reacts fiercely with cyanides when heated or by friction. May form explosive mixtures with combustible material. Powder of metals and alloys is sensitive to friction and are liable to ignite. When involved in a fire, may cause an explosion.	1490
1491	POTASSIUM PEROXIDE	5.1	-	I	-	0	E0	P503	-	IBC06	B1	-	-	F-G, S-Q	Category B. Keep as dry as reasonably practicable. "Separated from" permanganates, acids and class 4.1.	Yellow powder. Particularly if wetted with small quantities of water, a mixture with combustible material may ignite, following impact or friction. When involved in a fire, or in contact with water or acids, decomposes, evolving oxygen. Highly irritating to skin, eyes and mucous membranes.	1491
1492	POTASSIUM PERSULPHATE	5.1	-	III	-	5 kg	E1	P002 LP02	-	IBC08	B3	T1	TP33	F-A, S-Q	Category A. "Separated from" ammonium compounds other than peroxides. "Separated from" PERMANGANATE (UN 1444), and cyanides.	White crystals or powder. Soluble in water. Mixtures with combustible material are sensitive to friction and are liable to ignite. Reacts fiercely with ammonium compounds, cyanides and peroxides. May form explosive mixture with powdered metals or ammonium compounds.	1492
1493	SILVER NITRATE	5.1	-	II	-	1 kg	E2	P002	-	IBC08	B2 B4	T3	TP33	F-A, S-Q	Category A.	Colourless crystals. Soluble in water. Mixtures with combustible material are readily ignited and may burn fiercely. Harmful if swallowed. Irritating to skin and mucous membranes.	1493



UN No. (1)	PSN (2)	Class No. (3)	Subsidiary Risk(s) (4)	Packing Group (5)	Special Provisions (6)	Limited quantities (7a)	Excepted quantities (7b)	Packing		IBC	
								Instruc-tions (8)	Provisions (9)	Instruc-tions (10)	Provisions (11)
3.1.2		2.0	2.0	2.0, 1.3	3.3	3.4	3.5	4.1, 4	4.1, 4		
5.1		5.1	-	II	-	1 kg	E2	P002	-	IBC08	B2 B4

UN No. (16)	Properties and Observations (17)	Portable tanks and bulk containers		Stowage and Segregation (16)	Category A. "Separated from" ammonium compounds and cyanides.	F-H, S-Q	F-H, S-Q	EHS (15)
		Tank instructions (15)	Provisions (14)					
1494	White deliquescent crystals. Soluble in water. Reacts vigorously with sulphuric acid. Reacts fiercely with cyanides when heated or by friction. May form explosive mixtures with combustible material, powdered metals or ammonium compounds. These mixtures are sensitive to friction and are liable to ignite. When involved in a fire, may cause an explosion.	T3	TP33	Category A. "Separated from" ammonium compounds and cyanides.	F-H, S-Q	F-H, S-Q	4.2.5 4.3	(15) 7.8

1495 SODIUM CHLORATE	Colourless deliquescent crystals. Soluble in water. Reacts vigorously with sulphuric acid. Reacts fiercely with cyanides when heated or by friction. May form explosive mixtures with combustible material, powdered metals or ammonium compounds. These mixtures are sensitive to friction and are liable to ignite. When involved in a fire, may cause an explosion.	T3	TP33	Category A. "Separated from" ammonium compounds and cyanides.	F-H, S-Q	F-H, S-Q	4.2.5 4.3	(15) 7.8	1495
1496 SODIUM CHLORITE	Colourless deliquescent solid. Soluble in water. Reacts vigorously with sulphuric acid. Reacts fiercely with cyanides when heated or by friction. May form explosive mixtures with combustible material, powdered metals or ammonium compounds. These mixtures are sensitive to friction and are liable to ignite. When involved in a fire, may cause an explosion.	T3	TP33	Category A. "Separated from" ammonium compounds and cyanides.	F-H, S-Q	F-H, S-Q			1496
1498 SODIUM NITRATE	Colourless deliquescent solid. Soluble in water. Mixtures with combustible material are readily ignited and may burn fiercely. (This substance in the impure form is known as Chile Saltpetre.)	T1 BK2, BK3	TP33	Category A. When transported in BK3 bulk containers, see 7.6.2.1.2 and 7.7.3.9.	F-A, S-Q	F-A, S-Q			1498
1499 SODIUM NITRATE AND POTASSIUM NITRATE MIXTURE	Colourless, hygroscopic solid. Soluble in water. Mixtures with combustible material are readily ignited and may burn fiercely. Harmful if swallowed. Mixture prepared as a fertilizer.	T1 BK2, BK3	TP33	Category A. When transported in BK3 bulk containers, see 7.6.2.1.2 and 7.7.3.9.	F-A, S-Q	F-A, S-Q			1499
1500 SODIUM NITRITE	Colourless deliquescent solid. Soluble in water. Mixtures with combustible material are readily ignited and may burn fiercely. Mixtures with ammonium compounds or cyanides may explode. Decomposes, if heated, giving off toxic nitrous fumes and gases supporting combustion. Harmful, if swallowed or by dust inhalation.	T1	TP33	Category A. "Separated from" ammonium compounds and cyanides.	F-A, S-Q	F-A, S-Q			1500
1502 SODIUM PERCHLORATE	Colourless crystals or powder, soluble in water. Reacts vigorously with sulphuric acid. Reacts fiercely with cyanides when heated or by friction. May form explosive mixtures with combustible material. These mixtures are sensitive to friction and are liable to ignite. When involved in a fire, may cause an explosion.	T3	TP33	Category A. "Separated from" ammonium compounds and cyanides.	F-H, S-Q	F-H, S-Q			1502
1503 SODIUM PERSULPHATE	Red crystals or powder. Soluble in water. Reacts vigorously with sulphuric acid and hydrogen peroxide. Reacts fiercely with cyanides when heated or by friction. May form explosive mixtures with combustible material, powdered metals or ammonium compounds. These mixtures are sensitive to friction and are liable to ignite. When involved in a fire, may cause an explosion.	T3	TP33	Category D. "Separated from" ammonium compounds, cyanides and peroxides.	F-H, S-Q	F-H, S-Q			1503
1504 SODIUM PEROXIDE	Pale yellow coarse powder or crystals. Particularly if wetted with small quantities of water, a mixture with combustible material may ignite, following impact or friction. When involved in a fire, or in contact with water or acids, decomposes, evolving oxygen. Highly irritating to skin, eyes and mucous membranes.	-	-	Category B. Keep as dry as reasonably practicable. "Separated from" permanganates, acids and class 4.1.	F-C, S-Q	F-C, S-Q			1504
1505 SODIUM PERSULPHATE	Colourless crystals or powder. Soluble in water. Mixtures with combustible material are sensitive to friction and are liable to ignite. Reacts fiercely with ammonium compounds. May form explosive mixtures with powdered metals or ammonium compounds.	T1	TP33	Category A. "Separated from" ammonium compounds, other than ammonium persulphate (UN 1444), and cyanides.	F-A, S-Q	F-A, S-Q			1505
1506 STRONTIUM CHLORATE	Colourless deliquescent solid, soluble in water. Reacts vigorously with ammonium compounds. May form explosive mixtures with combustible material, powdered metals or ammonium compounds. These mixtures are sensitive to friction and are liable to ignite. When involved in a fire, may cause an explosion.	T3	TP33	Category A. "Separated from" ammonium compounds and cyanides.	F-H, S-Q	F-H, S-Q			1506
1507 STRONTIUM NITRATE	Colourless solid. Soluble in water. Mixtures with combustible material are readily ignited and may burn fiercely. Harmful if swallowed.	T1	TP33	Category A.	F-A, S-Q	F-A, S-Q			1507
1508 STRONTIUM PERCHLORATE	Colourless crystals or powder, soluble in water. Reacts vigorously with sulphuric acid. Reacts fiercely with cyanides when heated or by friction. May form explosive mixtures with combustible material, powdered metals or ammonium compounds. These mixtures are sensitive to friction and are liable to ignite. When involved in a fire, may cause an explosion.	T3	TP33	Category A. "Separated from" ammonium compounds and cyanides.	F-H, S-Q	F-H, S-Q			1508
1509 STRONTIUM PEROXIDE	Colourless powder. Particularly if wetted with small quantities of water, a mixture with combustible materials may ignite following impact or friction. When involved in a fire, or in contact with water or acids, decomposes, evolving oxygen.	T3	TP33	Category A. Keep as dry as reasonably practicable. "Separated from" permanganates, acids and class 4.1.	F-C, S-Q	F-C, S-Q			1509

**TSFS 2015:66**  
**Bilaga 1**

UN No. (1)	PSN (2)	Class No. (3)	Subsidiary Risk(s) (4)	Packing Group (5)	Special Provisions (6)	Limited quantities (7a)	Excepted quantities (7b)	Packing		IBC		Portable tanks and bulk containers		EMS (15)	Stowage and Segregation (16)	Properties and Observations (17)	UN No. (18)
								Institutions (8)	Provisions (9)	Institutions (10)	Provisions (11)	Tank instructions (12)	Provisions (13)				
1510	TETRAMETHANE	6.1	5.1	I	354	0	E0	P602	-	-	-	-	F-H, S-Q	Category D. Clear of living quarters. "Separated from" class 4.1.	Colourless liquid with a pungent odour. Freezing point: 12.5°C. Insoluble in water. Flammable. May explode by friction or shock. Highly toxic if swallowed, by skin contact or by inhalation.	1510	
1511	UREA HYDROGEN PEROXIDE	5.1	8	III	-	5 kg	E1	P002	-	IBC08	B3	T1	TP33	F-A, S-Q	Category A. Keep as dry as reasonably practicable.	White crystals or powder. Soluble in water. Mixtures with combustible materials are sensitive to friction and are liable to ignite. Irritating to skin, eyes and mucous membranes.	1511
1512	ZINC AMMONIUM NITRATE	5.1	-	-	900	-	-	-	-	-	-	-	-	-	Transport is prohibited.		1512
1513	ZINC CHLORATE	5.1	-	II	-	1 kg	E2	P002	-	IBC08	B2 B4	T3	TP33	F-H, S-Q	Category A. "Separated from" ammonium compounds and cyanides.	Colourless or yellowish crystals. Soluble in water. Reacts vigorously with sulphuric acid. Reacts fiercely with cyanides when heated or by friction. May form explosive mixtures with combustible material. Powdered metals are liable to ignite. When involved in a fire, may cause an explosion.	1513
1514	ZINC NITRATE	5.1	-	II	-	1 kg	E2	P002	-	IBC08	B2 B4	T3	TP33	F-H, S-Q	Category A.	Colourless solid. Soluble in water. Melting point: 36°C. Mixtures with combustible materials are sensitive to friction. Solutions in water are slightly corrosive. Harmful if swallowed.	1514
1515	ZINC FERMANGANATE	5.1	-	II	-	1 kg	E2	P002	-	IBC06	B2	T3	TP33	F-H, S-Q	Category D. "Separated from" ammonium compounds, cyanides and peroxides.	Violet, brown or black crystals or powder. Soluble in water. Reacts vigorously with sulphuric acid and hydrogen peroxide. Reacts fiercely with cyanides when heated or by friction. May form explosive mixtures with combustible material. Powdered metals or ammonium compounds. These mixtures are sensitive to friction and are liable to ignite. When involved in a fire, may cause an explosion.	1515
1516	ZINC PEROXIDE	5.1	-	II	-	1 kg	E2	P002	-	IBC06	B2	T3	TP33	F-G, S-Q	Category A. Keep as dry as reasonably practicable. "Separated from" peranganates, acids and peroxides.	White powder. Particularly if wetted with small quantities of water, a highly explosive mixture may be formed. When involved in a fire, or in contact with water or acids, decomposes, evolving oxygen.	1516
1517	ZIRCONIUM PICRAMATE, WETTED with not less than 20% water, by mass	4.1	-	I	28	0	E0	P406 PP26 PP31	-	-	-	-	-	F-B, S-J	Category D. "Away from" class 3 and heavy metals and their salts.	Desensitized explosive. Highly explosive in the dry state or if insufficiently wetted. May react violently in contact with heavy metals or their salts.	1517
1541	ACETONE CYANOHYDRIN, STABILIZED	6.1	-	I	354	0	E0	P602	-	-	-	T20 TPI3 TP37	TP2	F-A, S-A	Category D. Protected from sources of heat. Clear of living quarters. "Separated from" acids and alkalis.	Colourless to amber liquid evolving toxic vapour. Miscible with water. Unstable in contact with acids and alkalis, evolving hydrogen cyanide, a highly toxic and flammable gas. Highly toxic if swallowed, by skin contact or by inhalation.	1541
1544	ALKALOIDS, SOLID, N.O.S. or ALKALOIDS SALTS, SOLID, N.O.S.	6.1	-	I	43 274	0	E5	P002	-	IBC07	B1	T6	TP33	F-A, S-A	Category A.	A wide range of toxic solids, generally of vegetable origin. Toxic if swallowed, by skin contact or by inhalation.	1544
1544	ALKALOIDS, SOLID, N.O.S. or ALKALOIDS SALTS, SOLID, N.O.S.	6.1	-	II	43 274	500 g	E4	P002	-	IBC08	B2 B4	T3	TP33	F-A, S-A	Category A.	See entry above.	1544
1544	ALKALOIDS, SOLID, N.O.S. or ALKALOIDS SALTS, SOLID, N.O.S.	6.1	-	III	43 223 274	5 kg	E1	P002 LP02	-	IBC08	B3	T1	TP33	F-A, S-A	Category A.	See entry above	1544
1545	ALLYL ISOTHIOCYANATE, STABILIZED	6.1	3	II	-	100 ml	E4	P001	-	IBC02	-	T7	TP2	F-E, S-D	Category D. Clear of living quarters.	Colourless liquid evolving toxic vapour which is irritating and causes tears. Flashpoint: 46°C c.c. Toxic if swallowed, by skin contact or by inhalation.	1545
1546	AMMONIUM ARSENATE	6.1	-	II	-	500 g	E4	P002	-	IBC08	B2 B4	T3	TP33	F-A, S-A	Category A. "Separated from" alkalis.	White powder or crystals. Soluble in water. Reacts with alkalis, evolving ammonia gas. Toxic if swallowed, by skin contact or by dust inhalation.	1546
1547	ANILINE	6.1	-	II	279	100 ml	E4	P001	-	IBC02	-	T7	TP2	F-A, S-A	Category A. Clear of living quarters. "Separated from" acids.	Colourless, oily, volatile liquid. Reacts with acids. Toxic if swallowed, by skin contact or by inhalation.	1547

UN No. (1)	PSN (2)	Class or Div (3)	Subsidiary Risk(s) (4)	Packing Group (5)	Special Provisions (6)	Limited quantities (7a)	Excepted quantities (7b)	Packing			IBC			UN No. (18)	Properties and Observations (17)				
								Class or Div (3)	Subsidiary Risk(s) (4)	Packing Group (5)	Special Provisions (6)	Limited quantities (7a)	Excepted quantities (7b)			Instructions (8)	Provisions (9)	Instructions (10)	Provisions (11)
	3.1.2	2.0	2.0	2.0	2.0, 1.3	3.3	3.4	3.5	4.1, 4	4.1, 4	4.1, 4	4.1, 4							
1548	ANILINE HYDROCHLORIDE	6.1	-	III	-	5 kg	E1	P002 LP02	-	IBC08	B3		TI	TP33	F-A, S-A	Category A.	White, crystalline solid. Soluble in water. Decomposes to aniline in contact with alkalis. Toxic if swallowed, by skin contact or by inhalation.	1548	
1549	ANTIMONY COMPOUND, INORGANIC, SOLID, N.O.S.	6.1	-	III	4.5 274	5 kg	E1	P002 LP02	-	IBC08	B3		TI	TP33	F-A, S-A	Category A.	A wide range of toxic solids. Toxic if swallowed, by skin contact or by inhalation.	1549	
1550	ANTIMONY LACTATE	6.1	-	III	-	5 kg	E1	P002 LP02	-	IBC08	B3		TI	TP33	F-A, S-A	Category A.	White powder or crystals. Toxic if swallowed, by skin contact or by dust inhalation.	1550	
1551	ANTIMONY POTASSIUM TARTRATE	6.1	-	III	-	5 kg	E1	P002 LP02	-	IBC08	B3		TI	TP33	F-A, S-A	Category A.	Colourless crystals or white powder. Toxic if swallowed, by skin contact or by dust inhalation.	1551	
1553	ARSENIC ACID, LIQUID	6.1	-	I	-	0	E5	P001	PP31	-	-		T20 TP2 TP7 TPI3	TP2 TP7 TPI3	F-A, S-A	Category B. "Away from" powdered metals.	White, deliquescent crystals which readily become liquid. Melting point: approximately 35°C. Miscible with water. In contact with metals, may evolve arsine, an extremely toxic gas. Highly toxic if swallowed, by skin contact or by inhalation.	1553	
1554	ARSENIC ACID, SOLID	6.1	-	II	-	500 g	E4	P002	-	IBC08	B2 B4		T3	TP33	F-A, S-A	Category A.	White crystals with a relatively high melting point. Soluble in water. Toxic if swallowed, by skin contact or by dust inhalation.	1554	
1555	ARSENIC BROMIDE	6.1	-	II	-	500 g	E4	P002	-	IBC08	B2 B4		T3	TP33	F-A, S-A	Category A.	White, deliquescent crystals. Melting point: approximately 33°C. Decomposed by water, evolving hydrogen bromide, an irritating and corrosive gas with visible fumes. Toxic if swallowed, by skin contact or by dust inhalation.	1555	
1556	ARSENIC COMPOUND, LIQUID, N.O.S. inorganic, including Arsenates, n.o.s., Arsenites, n.o.s., and Arsenic sulphides, n.o.s.	6.1	-	I	43 274	0	E5	P001	-	-	-		T14	TP2 TP3 TP7	F-A, S-A	Category B. Clear of living quarters, for arsenic sulphides, "Separated from" acids.	A wide variety of toxic liquids. In contact with acids, arsenic sulphide evolves hydrogen sulphide, a toxic and flammable gas. Toxic if swallowed, by skin contact or by inhalation.	1556	
1556	ARSENIC COMPOUND, LIQUID, N.O.S. inorganic, including Arsenates, n.o.s., Arsenites, n.o.s., and Arsenic sulphides, n.o.s.	6.1	-	II	43 274	100 ml	E4	P001	-	IBC02	-		T11	TP2 TP3 TP7	F-A, S-A	Category B. Clear of living quarters, for arsenic sulphides, "Separated from" acids.	See entry above.	1556	
1556	ARSENIC COMPOUND, LIQUID, N.O.S. inorganic, including Arsenates, n.o.s., Arsenites, n.o.s., and Arsenic sulphides, n.o.s.	6.1	-	III	43 223 274	5 l	E1	P001 LP01	-	IBC03	-		T7	TP2 TP8	F-A, S-A	Category B. Clear of living quarters, for arsenic sulphides, "Separated from" acids.	See entry above.	1556	
1557	ARSENIC COMPOUND, SOLID, N.O.S. inorganic, including Arsenates, n.o.s., Arsenites, n.o.s., and Arsenic sulphides, n.o.s.	6.1	-	I	43 274	0	E5	P002	-	IBC07	B1		T6	TP33	F-A, S-A	Category A. For arsenic sulphides, "Separated from" acids.	A wide variety of toxic solids. In contact with acids, arsenic sulphide evolves hydrogen sulphide, a toxic and flammable gas. Toxic if swallowed, by skin contact or by dust inhalation.	1557	
1557	ARSENIC COMPOUND, SOLID, N.O.S. inorganic, including Arsenates, n.o.s., Arsenites, n.o.s., and Arsenic sulphides, n.o.s.	6.1	-	II	43 274	500 g	E4	P002	-	IBC08	B2 B4		T3	TP33	F-A, S-A	Category A. For arsenic sulphides, "Separated from" acids.	See entry above.	1557	
1557	ARSENIC COMPOUND, SOLID, N.O.S. inorganic, including Arsenates, n.o.s., Arsenites, n.o.s., and Arsenic sulphides, n.o.s.	6.1	-	III	43 223 274	5 kg	E1	P002 LP02	-	IBC08	B3		TI	TP33	F-A, S-A	Category A. For arsenic sulphides, "Separated from" acids.	See entry above.	1557	
1558	ARSENIC	6.1	-	II	-	500 g	E4	P002	-	IBC08	B2 B4		T3	TP33	F-A, S-A	Category A.	Silvery, brittle, crystalline solid with the appearance of a metal. Toxic if swallowed, by skin contact or by dust inhalation.	1558	
1559	ARSENIC PENTOXIDE	6.1	-	II	-	500 g	E4	P002	-	IBC08	B2 B4		T3	TP33	F-A, S-A	Category A.	White, deliquescent powder. Soluble in water. Toxic if swallowed, by skin contact or by dust inhalation.	1559	

**TSFS 2015:66**  
**Bilaga 1**

UN No. (1)	PSN (2)	Class No. (3)	Subsidiary Risk(s) (4)	Packing Group (5)	Special Provisions (6)	Limited quantities (7a)	Excepted quantities (7b)	Instruct-ions (8)	Packing		IBC		Provision No. (11)	Portable tanks and bulk containers	EMs (15)	Stowage and Segregation (16)	Properties and Observations (17)	UN No. (18)	
									Instruct-ions (9)	Provisions (10)	Instruc-tions (10)	Provisions (11)							Tank instructions (12)
	3.1.2	2.0	2.0	2.0	1.3	3.3	3.4	3.5	4.1, 4	4.1, 4	4.1, 4		T14	TP2, TP3	F-A, S-A	Category B. Clear of living quarters.	Colourless, oily liquid. Flumes in moist air, evolving hydrogen chloride, an extremely toxic gas. Highly toxic if swallowed, by skin contact or by inhalation.	1560	
1561	ARSENIC TRICHLORIDE	6.1	-	I	-	0	E5	P602	-	-	-	-	T3	TP33	F-A, S-A	Category A.	White powder. Slightly soluble in water. Toxic if swallowed, by skin contact or by dust inhalation.	1561	
1562	ARSENICAL DUST	6.1	-	II	-	500 g	E4	P002	-	IBC08 B2 B4	IBC08 B2 B4	-	T3	TP33	F-A, S-A	Category A.	Fine powder. Toxic if swallowed, by skin contact or by dust inhalation.	1562	
1564	BARIUM COMPOUND, N.O.S.	6.1	-	II	177	274	500 g	E4	P002	-	IBC08 B2 B4	IBC08 B2 B4	-	T3	TP33	F-A, S-A	Category A.	White powder, lumps or crystals. Toxic if swallowed, by skin contact or by inhalation.	1564
1564	BARIUM COMPOUND, N.O.S.	6.1	-	III	177	274	5 kg	E1	P002, U02	-	IBC08 B3	IBC08 B3	-	T1	TP33	F-A, S-A	Category A.	See entry above.	1564
1565	BARIUM CYANIDE	6.1	-	I	-	0	E5	P002	PP31	IBC07 B1	IBC07 B1	-	T6	TP33	F-A, S-A	Category A. Separated from acids.	White crystals or powder. Soluble in water. Reacts with acids or acid fumes, evolving hydrogen cyanide, a highly toxic and flammable gas. Highly toxic if swallowed, by skin contact or by dust inhalation.	1565	
1566	BERYLLIUM COMPOUND, N.O.S.	6.1	-	II	274	500 g	E4	P002	-	IBC08 B2 B4	IBC08 B2 B4	-	T3	TP33	F-A, S-A	Category A.	A wide range of toxic solids. Toxic if swallowed, by skin contact or by dust inhalation.	1566	
1566	BERYLLIUM COMPOUND, N.O.S.	6.1	-	III	274	5 kg	E1	P002, U02	-	IBC08 B3	IBC08 B3	-	T1	TP33	F-A, S-A	Category A.	See entry above.	1566	
1567	BERYLLIUM POWDER	6.1	4.1	II	-	500 g	E4	P002	-	IBC08 B2 B4	IBC08 B2 B4	-	T3	TP33	F-C, S-C	Category A.	White, metallic powder. Toxic if swallowed, by skin contact or by dust inhalation.	1567	
1569	BROMOACETONE	6.1	3	II	-	0	E4	P602	-	-	-	-	T20	TP2, TP13	F-E, S-D	Category D. Clear of living quarters.	When pure, colourless liquid evolving irritating vapour ("Tear Gas"). Flashpoint: approximately 45°C c.c. Toxic if swallowed, by skin contact or by inhalation.	1569	
1570	BRIICINE	6.1	-	I	43	0	E5	P002	-	IBC07 B1	IBC07 B1	-	T6	TP33	F-A, S-A	Category A.	White crystals or powder. Highly toxic if swallowed, by skin contact or by dust inhalation.	1570	
1571	BARIUM AZIDE, WETTED with not less than 50% water, by mass	4.1	6.1	I	28	0	ED	P406	PP31	-	-	-	-	-	F-6, S-J	Category D. "Away from" class 3 and heavy metals and their salts.	Desensitized explosive. White crystals or powder. Explosive and sensitive to friction in the dry state. Toxic if swallowed, by skin contact or by dust inhalation. May form extremely sensitive compounds with heavy metals or their salts.	1571	
1572	CACODYLIC ACID	6.1	-	II	-	500 g	E4	P002	-	IBC08 B2 B4	IBC08 B2 B4	-	T3	TP33	F-A, S-A	Category E. Separated from acids.	Colourless crystals or white powder with an offensive odour. Soluble in water. May react with acids, evolving dimethylarsine, an extremely toxic gas. Toxic if swallowed, by skin contact or by dust inhalation.	1572	
1573	CALCIUM ARSENATE	6.1	P	II	-	500 g	E4	P002	-	IBC08 B2 B4	IBC08 B2 B4	-	T3	TP33	F-A, S-A	Category A.	White powder. Slightly soluble in water. Toxic if swallowed, by skin contact or by dust inhalation.	1573	
1574	CALCIUM ARSENATE AND CALCIUM ARSENITE MIXTURE, SOLID	6.1	P	II	-	500 g	E4	P002	-	IBC08 B2 B4	IBC08 B2 B4	-	T3	TP33	F-A, S-A	Category A.	White powder. Toxic if swallowed, by skin contact or by dust inhalation.	1574	
1575	CALCIUM CYANIDE	6.1	P	I	-	0	E5	P002	PP31	IBC07 B1	IBC07 B1	-	T6	TP33	F-A, S-A	Category A. Separated from acids.	White crystals or powder. Decomposes slowly in water to form a weak hydrogen cyanide solution. Reacts with acids or acid fumes, evolving hydrogen cyanide, a highly toxic and flammable gas. Highly toxic if swallowed, by skin contact or by dust inhalation.	1575	

UN No. (1)	PSN (2)	Class No. (3)	Subsidiary Risk(s) (4)	Packing Group (5)	Special Provisions (6)	Limited quantities (7a)	Excepted quantities (7b)	Packing		IBC		UN No. (18)
								Instruc-tions (8)	Provisions (9)	Instruc-tions (10)	Provisions (11)	
6.1	P	II	279	100 mf	E4	P001	-	IBC02	-	-	-	1577
1577 CHLORODINITROBENZENES, LIQUID												
6.1	-	II	279	500 g	E4	P002	-	IBC08	B2	B4	-	1578
1578 CHLORONITROBENZENES, SOLID												
6.1	-	III	-	5 kg	E1	P002	LPO2	IBC08	B3	-	-	1579
1579 4-CHLORO-o-TOLUIDINE HYDROCHLORIDE, SOLID												
6.1	-	I	354	0	ED	P601	-	-	-	-	-	1580
1580 CHLOROPICRIN												
2.3	-	-	-	0	ED	P200	-	-	-	-	-	1581
1581 CHLOROPICRIN AND METHYL BROMIDE MIXTURE with more than 2% chloropicrin												
2.3	-	-	-	0	ED	P200	-	-	-	-	-	1582
1582 CHLOROPICRIN AND METHYL CHLORIDE MIXTURE												
6.1	-	I	43	0	ES	P602	-	-	-	-	-	1583
1583 CHLOROPICRIN MIXTURE, N.O.S.												
6.1	-	II	43	100 mf	E4	P001	-	IBC02	-	-	-	1583
1583 CHLOROPICRIN MIXTURE, N.O.S.												
6.1	-	III	43	5 l	E1	P001	LPO1	IBC03	-	-	-	1583
1583 CHLOROPICRIN MIXTURE, N.O.S.												
6.1	-	II	-	500 g	E4	P002	-	IBC08	B2	B4	-	1585
1585 COPPER ACETOARSENITE												
6.1	-	II	-	500 g	E4	P002	-	IBC08	B2	B4	-	1586
1586 COPPER ARSENITE												
6.1	-	II	-	500 g	E4	P002	-	IBC08	B2	B4	-	1587
1587 COPPER CYANIDE												
6.1	-	I	47	0	E5	P002	-	IBC07	B1	-	-	1588
1588 CYANIDES, INORGANIC, SOLID, N.O.S.												
6.1	-	II	47	500 g	E4	P002	-	IBC08	B2	B4	-	1588
1588 CYANIDES, INORGANIC, SOLID, N.O.S.												
6.1	-	III	47	5 kg	E1	P002	LPO2	IBC08	B3	-	-	1588
1588 CYANIDES, INORGANIC, SOLID, N.O.S.												

# TSFS 2015:66

## Bilaga 1

UN No. (1)	PSN (2)	Class No. or Div (5)	Subsidiary Risk(s) (4)	Packing Group (3)	Special Provisions (6)	Limited quantities (7a)	Excepted quantities (7b)	Packing		IBC	Portable tanks and bulk containers Tank instructions (15)	EHS (15)	Storage and Segregation (16)	Properties and Observations (17)	UN No. (18)
								Institutions (8)	Provisions (9)						
1589	CYANOGEN CHLORIDE, STABILIZED	2.3	8	-	-	0	EO	P200	-	-	-	F-C, S-U	Category D. Clear of living quarters.	Liquefied, non-flammable, toxic and corrosive gas with an irritating odour. May explode if involved in a fire. Toxic if inhaled. May react violently to give off highly toxic and corrosive fumes. Much heavier than air (2.1). Boiling point: 13 °C. Toxic by skin contact or by inhalation. Highly irritating to skin, eye and mucous membranes.	1589
1590	DICHLOROANILINES, LIQUID	6.1	P	II	279	100 ml f	E4	P001	-	IBC02	T7	TP2	F-A, S-A	Category A. Clear of living quarters.	1590
1591	o-DICHLOROENZENE	6.1	-	III	279	5 ℓ	E1	P001 LP1	-	IBC03	T4	TP1	F-A, S-A	Category A.	1591
1593	DICHLOROMETHANE	6.1	-	III	-	5 ℓ	E1	P001 LP1	-	IBC03	T7	TP2	F-A, S-A	Category A.	1593
1594	DIETHYL SULPHATE	6.1	-	II	-	100 ml f	E4	P001	-	IBC02	T7	TP2	F-A, S-A	Category C.	1594
1595	DIMETHYL SULPHATE	6.1	8	I	354	0	EO	P602	-	-	T20 TP13 TP35	TP2	F-A, S-B	Category D. Clear of living quarters.	1595
1596	DINITROANILINES	6.1	-	II	-	500 g	E4	P002	-	IBC08 B2 B4	T3	TP33	F-A, S-A	Category A. "Separated from" class 3.	1596
1597	DINITROBENZENES, LIQUID	6.1	-	II	-	100 ml f	E4	P001	-	IBC03	T7	TP2	F-A, S-A	Category A. "Separated from" class 3.	1597
1597	DINITROBENZENES, LIQUID	6.1	-	III	223	5 ℓ	E1	P001 LP1	-	IBC03	T7	TP2	F-A, S-A	Category A. "Separated from" class 3.	1597
1598	DINITRO-o-CRESOL	6.1	P	II	43	500 g	E4	P002	-	IBC08 B2 B4	T3	TP33	F-A, S-A	Category A.	1598
1599	DINITROPHENOL SOLUTION	6.1	P	II	-	100 ml f	E4	P001	-	IBC02	T7	TP2	F-A, S-A	Category A. "Away from" heavy metals and their salts.	1599
1599	DINITROPHENOL SOLUTION	6.1	-	III	223	5 ℓ	E1	P001 LP1	-	IBC03	T4	TP1	F-A, S-A	Category A. "Away from" heavy metals and their salts.	1599
1600	DINITROTOLUENES, MOLTEN	6.1	-	II	-	0	EO	-	-	-	T7	TP3	F-A, S-A	Category C.	1600
1601	DISINFECTANT, SOLID, TOXIC, N.O.S.	6.1	-	I	274	0	ES	P002	-	IBC07	T6	TP33	F-A, S-A	Category A. Clear of living quarters.	1601
1601	DISINFECTANT, SOLID, TOXIC, N.O.S.	6.1	-	II	274	500 g	E4	P002	-	IBC08 B2 B4	T3	TP33	F-A, S-A	Category A. Clear of living quarters. See entry above.	1601
1601	DISINFECTANT, SOLID, TOXIC, N.O.S.	6.1	-	III	223 274	5 kg	E1	P002 LP2	-	IBC08	T1	TP33	F-A, S-A	Category A. Clear of living quarters. See entry above.	1601

UN No. (1)	PSN (2)	Class No. (3)	Subsidiary Risk(s) (4)	Packing Group (5)	Special Provisions (6)	Limited quantities (7a)	Excepted quantities (7b)	Packing		IBC		Portable tanks and bulk containers	EMS (15)	Stowage and Segregation (16)	Properties and Observations (17)	UN No. (18)	
								Institutions (8)	Provisions (9)	Institutions (10)	Provisions (11)						Tank instructions (12)
6.1	-	I	274	0	ES	P001	-	-	-	-	-	-	F-A, S-A	Category A.	A. wide range of toxic liquids. Toxic if swallowed, by skin contact or by inhalation.	1602	
1602	DYE LIQUID, TOXIC, N.O.S. or DYE INTERMEDIATE, LIQUID, TOXIC, N.O.S.																
6.1	-	II	274	100 ml	E4	P001	-	IBC02	-	-	-	-	F-A, S-A	Category A.	See entry above.	1602	
1602	DYE LIQUID, TOXIC, N.O.S. or DYE INTERMEDIATE, LIQUID, TOXIC, N.O.S.																
6.1	-	III	274	5 l	E1	P001	-	IBC03	-	-	-	-	F-A, S-A	Category A.	See entry above.	1602	
1602	DYE LIQUID, TOXIC, N.O.S. or DYE INTERMEDIATE, LIQUID, TOXIC, N.O.S.																
6.1	-	II	-	100 ml	E4	P001	-	IBC02	-	-	-	-	F-E, S-D	Category D.	Colourless, flammable liquid evolving irritating vapour ("Toxic Gas"). Flashpoint: 58°C cc. Toxic if swallowed, by skin contact or by inhalation.	1603	
1603	ETHYL BROMOACETATE																
8	3	II	-	1 l	E2	P001	-	IBC02	-	-	-	-	F-E, S-C	Category A.	Clear of living quarters. Volatile, colourless, hygroscopic flammable liquid with an ammonia-like odour. Flashpoint: 34°C cc. Miscible with water. Causes burns to skin, eyes and mucous membranes. Reacts violently with acids.	1604	
1604	ETHYLENEDIAMINE																
6.1	-	I	354	0	E0	P602	-	-	-	-	-	-	F-A, S-A	Category D.	Clear of living quarters. Colourless, volatile liquid. Highly toxic if swallowed, by skin contact or by inhalation.	1605	
1605	ETHYLENE DIBROMIDE																
6.1	-	II	-	500 g	E4	P002	-	IBC08	B2	B4	-	-	F-A, S-A	Category A.	Green crystals or powder. Insoluble in water. Toxic if swallowed, by skin contact or by dust inhalation.	1606	
1606	FERRIC ARSENATE																
6.1	-	II	-	500 g	E4	P002	-	IBC08	B2	B4	-	-	F-A, S-A	Category A.	Brown or yellow powder. Insoluble in water. Toxic if swallowed, by skin contact or by dust inhalation.	1607	
1607	FERRIC ARSENITE																
6.1	-	II	-	500 g	E4	P002	-	IBC08	B2	B4	-	-	F-A, S-A	Category A.	Green powder. Insoluble in water. Toxic if swallowed, by skin contact or by dust inhalation.	1608	
1608	FERROUS ARSENATE																
6.1	-	II	-	100 ml	E4	P001	-	IBC02	-	-	-	-	F-A, S-A	Category E.	Clear of living quarters. Yellow liquid. Miscible with water. Toxic if swallowed, by skin contact or by inhalation.	1611	
1611	HEXAETHYL TETRAPHOSPHATE																
2.3	-	-	-	0	E0	P200	-	-	-	-	-	-	F-C, S-U	Category D.	Clear of living quarters. Toxic if swallowed, by skin contact or by inhalation.	1612	
1612	HEXAETHYL TETRAPHOSPHATE AND COMPRESSED GAS MIXTURE																
6.1	-	I	900	0	ES	P601	-	-	-	-	-	-	F-A, S-A	Category D.	Clear of living quarters. Colourless liquid evolving extremely toxic vapour with a bitter almond odour. Flashpoint: 20°C cc. Miscible with water. Toxic if swallowed, by skin contact or by dust inhalation. The solution of HYDROCYANIC ACID, AQUEOUS SOLUTION with more than 20% hydrogen cyanide and of HYDROGEN CYANIDE, AQUEOUS SOLUTION with more than 20% hydrogen cyanide and of HYDROGEN CYANIDE, AQUEOUS SOLUTION with more than 20% hydrogen cyanide is prohibited.	1613	
1613	HYDROCYANIC ACID, AQUEOUS SOLUTION (HYDROGEN CYANIDE, AQUEOUS SOLUTION) with not more than 20% hydrogen cyanide																
6.1	-	I	-	0	E5	P099	-	-	-	-	-	-	F-A, S-U	Category D.	Protected from sources. Very volatile, colourless liquid, evolving extremely toxic flammable vapours, absorbed in a porous inert material. Miscible with water. Highly toxic if swallowed, by skin contact or by inhalation.	1614	
1614	HYDROGEN CYANIDE, STABILIZED containing less than 3% water and absorbed in a porous inert material																
6.1	-	III	-	5 kg	E1	P002	-	IBC08	B3	-	-	-	F-A, S-A	Category A.	White crystals, or brown or grey lumps. Soluble in water. Toxic if swallowed, by skin contact or by inhalation.	1616	
1616	LEAD ACETATE																
6.1	-	II	-	500 g	E4	P002	-	IBC08	B2	B4	-	-	F-A, S-A	Category A.	White crystals or powder. Insoluble in water. Toxic if swallowed, by skin contact or by dust inhalation.	1617	
1617	LEAD ARSENATES																
6.1	-	II	-	500 g	E4	P002	-	IBC08	B2	B4	-	-	F-A, S-A	Category A.	White powder. Insoluble in water. Toxic if swallowed, by skin contact or by dust inhalation.	1618	
1618	LEAD ARSENITES																

**TSFS 2015:66  
Bilaga 1**

UN No. (1)	PSN (2)	Class No. (3)	Subsidiary Risk(s) (4)	Packing Group (5)	Special Provisions (6)	Limited quantities (7a)	Excepted quantities (7b)	Packing		IBC	
								Instructions (8)	Provisions (9)	Instructions (10)	Provisions (11)
3.1.2		2.0	2.0	2.0, 1.3	3.3	3.4	3.5	4.1, 4	4.1, 4	4.1, 4	
6.1	P	II		P002	E4	500 g				IBC08	B2 B4

UN No. (18)	Properites and Observations (17)	Storage and Segregation (16)	Portable tanks and bulk containers	
			EMs (15)	Provisions (14)
		7.1 to 7.7	4.2.5 4.3	4.2.5 4.3
1620	White powder. Slightly soluble in water. Reacts with acids or acid fumes, forming a highly flammable gas. Toxic if swallowed, by skin contact or by dust inhalation.	Category A. "Separated from" acids.	F-A, S-A	TP33

1621	LONDON PURPLE		6.1	P	II	43	500 g	E4	P002		IBC08	B2 B4	Mixture of arsenic trioxide, lime and ferric oxide, used as an insecticide. Insoluble in water. Toxic if swallowed, by skin contact or by dust inhalation.	TP33	F-A, S-A	Category A.	1621	
1622	MACHESIUM ARSENATE		6.1	P	II		500 g	E4	P002		IBC08	B2 B4	White crystals or powder. Insoluble in water. Toxic if swallowed, by skin contact or by dust inhalation.	TP33	F-A, S-A	Category A.	1622	
1623	MERCURIC ARSENATE		6.1	P	II		500 g	E4	P002		IBC08	B2 B4	Yellow crystals or powder. Insoluble in water. Toxic if swallowed, by skin contact or by dust inhalation.	TP33	F-A, S-A	Category A.	1623	
1624	MERCURIC CHLORIDE		6.1	P	II		500 g	E4	P002		IBC08	B2 B4	White crystals or powder. Soluble in water. Toxic if swallowed, by skin contact or by dust inhalation.	TP33	F-A, S-A	Category A.	1624	
1625	MERCURIC NITRATE		6.1	P	II		500 g	E4	P002		IBC08	B2 B4	White, deliquescent crystals or powder. Soluble in water. Toxic if swallowed, by skin contact or by dust inhalation.	TP33	F-A, S-A	Category A.	1625	
1626	MERCURIC POTASSIUM CYANIDE		6.1	P	I		0	E5	P002	PP31	IBC07	B1	Colourless crystals. Soluble in water. Reacts with acids, evolving hydrogen cyanide, a highly toxic and flammable gas. Highly toxic if swallowed, by skin contact or by dust inhalation.	T6	TP33	F-A, S-A	Category A.	1626
1627	MERCURIOS NITRATE		6.1	P	II		500 g	E4	P002		IBC08	B2 B4	Crystals or powder. Toxic if swallowed, by skin contact or by dust inhalation.	TP33	F-A, S-A	Category A.	1627	
1629	MERCURY ACETATE		6.1	P	II		500 g	E4	P002		IBC08	B2 B4	White crystals or powder. Toxic if swallowed, by skin contact or by dust inhalation.	TP33	F-A, S-A	Category A.	1629	
1630	MERCURY AMMONIUM CHLORIDE		6.1	P	II		500 g	E4	P002		IBC08	B2 B4	White crystals or powder. Insoluble in water. Toxic if swallowed, by skin contact or by dust inhalation.	TP33	F-A, S-A	Category A.	1630	
1631	MERCURY BENZOATE		6.1	P	II		500 g	E4	P002		IBC08	B2 B4	White crystals. Toxic if swallowed, by skin contact or by dust inhalation.	TP33	F-A, S-A	Category A.	1631	
1634	MERCURY BROMIDES		6.1	P	II		500 g	E4	P002		IBC08	B2 B4	White crystals or powder. Toxic if swallowed, by skin contact or by dust inhalation.	TP33	F-A, S-A	Category A.	1634	
1636	MERCURY CYANIDE		6.1	P	II		500 g	E4	P002		IBC08	B2 B4	White crystals or powder. Soluble in water. Reacts with acids or acid fumes, evolving hydrogen cyanide, a highly toxic and flammable gas. Toxic if swallowed, by skin contact or by dust inhalation.	TP33	F-A, S-A	Category A. "Separated from" acids.	1636	
1637	MERCURY GLUCONATE		6.1	P	II		500 g	E4	P002		IBC08	B2 B4	Solid. Soluble in water. Toxic if swallowed, by skin contact or by dust inhalation.	TP33	F-A, S-A	Category A.	1637	
1638	MERCURY IODIDE		6.1	P	II		500 g	E4	P002		IBC08	B2 B4	Red crystals or powder. Insoluble in water. Toxic if swallowed, by skin contact or by dust inhalation.	TP33	F-A, S-A	Category A.	1638	



UN No. (1)	PSN (2)	Class No. or Div (3)	Subsidiary Risk(s) (4)	Packing Group (5)	Special Provisions (6)	Limited quantities (7a)	Excepted quantities (7b)	Packing			IBC								
								Instruc-tions (8)	Provisions (9)	Instruc-tions (10)	Provisions (11)	Instruc-tions (12)	Provisions (13)	Instruc-tions (14)	Provisions (15)				
6.1	P	II	P	II	-	500 g	E4	P002	-	IBC08	B2	B4	T3	TP33	F-A, S-A	Category A.	Brown powder containing about 20% mercury. Toxic if swallowed, by skin contact or by dust inhalation.	1639	
1640	MERCURY OLEATE	6.1	P	II	-	500 g	E4	P002	-	IBC08	B2	B4	T3	TP33	F-A, S-A	Category A.	Yellow oily paste. Insoluble in water. Toxic if swallowed, by skin contact or by inhalation.	1640	
1641	MERCURY OXIDE	6.1	P	II	-	500 g	E4	P002	-	IBC08	B2	B4	T3	TP33	F-A, S-A	Category A.	Orange powder. Insoluble in water. Toxic if swallowed, by skin contact or by dust inhalation.	1641	
1642	MERCURY OXYCYANIDE, DESENSITIZED	6.1	P	II	900	500 g	E4	P002	-	IBC08	B2	B4	T3	TP33	F-A, S-A	Category A. "Separated from" acids and class 3.	White crystals or powder. Reacts with acids or acid fumes, evolving hydrogen cyanide, a highly toxic and flammable gas. May explode if involved in a fire. Toxic if swallowed, by skin contact or by dust inhalation. Should be sufficiently phlegmatized (mercury oxy-cyanide-mercury cyanide) in order to be transported. The phlegmatized material can be regarded as adequately phlegmatized, if mass fraction of mercury cyanide can be regarded as adequately phlegmatized. Transport of MERCURY OXYCYANIDE pure is prohibited.	1642	
1643	MERCURY POTASSIUM IODIDE	6.1	P	II	-	500 g	E4	P002	-	IBC08	B2	B4	T3	TP33	F-A, S-A	Category A.	Yellow, deliquescent crystals or powder. Soluble in water. Toxic if swallowed, by skin contact or by dust inhalation.	1643	
1644	MERCURY SALICYLATE	6.1	P	II	-	500 g	E4	P002	-	IBC08	B2	B4	T3	TP33	F-A, S-A	Category A.	White powder. Insoluble in water. Toxic if swallowed, by skin contact or by dust inhalation.	1644	
1645	MERCURY SULPHATE	6.1	P	II	-	500 g	E4	P002	-	IBC08	B2	B4	T3	TP33	F-A, S-A	Category A.	White crystals or powder. Decomposes in water, forming sulphuric acid. Toxic if swallowed, by skin contact or by dust inhalation.	1645	
1646	MERCURY THIOCYANATE	6.1	P	II	-	500 g	E4	P002	-	IBC08	B2	B4	T3	TP33	F-A, S-A	Category A.	White powder. Insoluble in water. Toxic if swallowed, by skin contact or by dust inhalation.	1646	
1647	METHYL BROMIDE AND ETHYLENE DIBROMIDE MIXTURE, LIQUID	6.1	P	I	354	0	E0	P602	-	-	-	-	T20	TP2	TP13	F-A, S-A	Category D. Clear of living quarters. Solutions of methyl bromide gas, evolving toxic vapour. Methyl bromide has a boiling point of approximately 4 C. Highly toxic if swallowed, by skin contact or by inhalation.	1647	
1648	ACETONITRILE	3	-	II	-	1 l	E2	P001	-	IBC02	-	-	T7	TP2	F-E, S-D	Category B. Clear of living quarters.	Colourless, volatile liquid. Flashpoint: 2°C. Explosive limits: 3% to 16%. Miscible with water. When involved in a fire, evolves toxic cyanide fumes. Harmful if swallowed, by skin contact or by inhalation.	1648	
1649	MOTOR FUEL ANTI-KNOCK MIXTURE	6.1	P	I	-	0	E5	P602	-	-	-	-	T14	TP2	TP13	F-A, S-A	Category D. Clear of living quarters. Protected from sources of heat.	Volatile liquids, evolving toxic vapour. Mixture of tetraethyllead or tetramethyllead with ethylene dibromide and ethylene dichloride. Insoluble in water. Highly toxic if swallowed, by skin contact or by inhalation.	1649
1650	beta-NAPHTHYLAMINE, SOLID	6.1	-	II	-	500 g	E4	P002	-	IBC08	B2	B4	T3	TP33	F-A, S-A	Category A.	White crystals. Toxic if swallowed, by skin contact or by inhalation.	1650	
1651	NAPHTHYLTHIOUREA	6.1	-	II	43	500 g	E4	P002	-	IBC08	B2	B4	T3	TP33	F-A, S-A	Category A.	White crystals or powder. Toxic if swallowed, by skin contact or by dust inhalation.	1651	
1652	NAPHTHYLENE	6.1	-	II	-	500 g	E4	P002	-	IBC08	B2	B4	T3	TP33	F-A, S-A	Category A.	Crystals or powder. Toxic if swallowed, by skin contact or by dust inhalation.	1652	
1653	NICKEL CYANIDE	6.1	-	II	-	500 g	E4	P002	-	IBC08	B2	B4	T3	TP33	F-A, S-A	Category A. "Separated from" acids.	Green crystals or powder. Insoluble in water. Reacts with acids or acid fumes, evolving hydrogen cyanide, a highly toxic and flammable gas. Toxic if swallowed, by skin contact or by dust inhalation.	1653	

# TSFS 2015:66 Bilaga 1

UN No. (1)	PSN No. (2)	Class or Div. (3)	Subsidiary Risk(s) (4)	Packing Group (5)	Special Provisions (6)	Limited quantities (7a)	Excepted quantities (7b)	Packing			IBC		
								Instruc-tions (8)	Provisions (9)	Instruc-tions (10)	Provisions (11)		
3.1.2		2.0	2.0	2.0, 1.3	3.3	3.4	3.5	4.1, 4	4.1, 4	4.1, 4			

UN No. (16)	Properties and Observations (17)	Portable tanks and bulk containers		Stowage and Segregation (16)	F-A, S-A Category A.
		Tank instructions (15)	Provisions (14)		
		4.2.5 4.3	4.2.5	5.4, 5.2 7.8	

1654	NICOTINE	6.1	-	II	-	100 ml	E4	P001	-	IBC02	-	F-A, S-A Category A.	Thick, colourless oil, turning brown on exposure to air. Miscible with water. Toxic if swallowed, by skin contact or by inhalation.	1654
1655	NICOTINE COMPOUND, SOLID, N.O.S. or NICOTINE PREPARATION, SOLID, N.O.S.	6.1	-	I	4.3 274	0	E0	P002	-	IBC07	B1	F-A, S-A Category B.	A wide variety of toxic solids. Toxic if swallowed, by skin contact or by dust inhalation.	1655
1655	NICOTINE COMPOUND, SOLID, N.O.S. or NICOTINE PREPARATION, SOLID, N.O.S.	6.1	-	II	4.3 274	500 g	E4	P002	-	IBC08	B2 B4	F-A, S-A Category A.	See entry above.	1655
1655	NICOTINE COMPOUND, SOLID, N.O.S. or NICOTINE PREPARATION, SOLID, N.O.S.	6.1	-	III	4.3 223 274	5 kg	E1	P002 LP02	-	IBC08	B3	F-A, S-A Category A.	See entry above.	1655
1656	NICOTINE HYDROCHLORIDE, LIQUID or SOLUTION	6.1	-	II	4.3	100 ml	E4	P001	-	IBC02	-	F-A, S-A Category A.	Miscible with water. Toxic if swallowed, by skin contact or by inhalation.	1656
1656	NICOTINE HYDROCHLORIDE, LIQUID or SOLUTION	6.1	-	III	4.3 223	5 l	E1	P001 LP01	-	IBC03	-	F-A, S-A Category A.	See entry above.	1656
1657	NICOTINE SALICYLATE	6.1	-	II	-	500 g	E4	P002	-	IBC08	B2 B4	F-A, S-A Category A.	White crystals. Soluble in water. Toxic if swallowed, by skin contact or by dust inhalation.	1657
1658	NICOTINE SULPHATE SOLUTION	6.1	-	II	-	100 ml	E4	P001	-	IBC02	-	F-A, S-A Category A.	Miscible with water. Toxic if swallowed, by skin contact or by inhalation.	1658
1658	NICOTINE SULPHATE SOLUTION	6.1	-	III	223	5 l	E1	P001 LP01	-	IBC03	-	F-A, S-A Category A.	See entry above.	1658
1659	NICOTINE TARTRATE	6.1	-	II	-	500 g	E4	P002	-	IBC08	B2 B4	F-A, S-A Category A.	White crystals. Soluble in water. Toxic if swallowed, by skin contact or by dust inhalation.	1659
1660	NITRIC OXIDE, COMPRESSED	2.3	5.1, 8	-	-	0	E0	P200	-	-	-	F-C, S-W Category D. Clear of living quarters. Segregation as for class 5.1 but 'Separated from' Class 7.	Non-flammable, toxic and corrosive gas. Strong oxidizing agent. On contact with air, gives off brown fumes which are toxic by inhalation, with irritating to the eyes and mucous membranes.	1660
1661	NITROANILINES (o-, m-, p-)	6.1	-	II	279	500 g	E4	P002	-	IBC08	B2 B4	F-A, S-A Category A.	Yellow crystals. Toxic if swallowed, by skin contact or by dust inhalation. ortho-NITROANILINES may be carried in the molten state.	1661
1662	NITROBENZENE	6.1	-	II	279	100 ml	E4	P001	-	IBC02	-	F-A, S-A Category A.	Clear of living quarters. Oily liquid, evolving toxic vapour. Melting point: approximately 6°C. Toxic if swallowed, by skin contact or by inhalation.	1662
1663	NITROPHENOLS (o-, m-, p-)	6.1	-	III	279	5 kg	E1	P002 LP02	-	IBC08	B3	F-A, S-A Category A.	Yellow crystals. Some isomers may have a melting point as low as 44°C. Toxic if swallowed, by skin contact or by dust inhalation. May be carried in the molten state.	1663
1664	NITROTOLUENES, LIQUID	6.1	-	II	-	100 ml	E4	P001	-	IBC02	-	F-A, S-A Category A.	Yellow liquids. Melting points: ortho-NITROTOLUENE: -4°C, meta-NITROTOLUENE: 15°C, toxic if swallowed, by skin contact or by inhalation.	1664
1665	NITROXYLENES, LIQUID	6.1	-	II	-	100 ml	E4	P001	-	IBC02	-	F-A, S-A Category A.	Yellow liquids. Melting points: 2-NITRO-3-XYLENE: 14°C to 18°C, 3-NITRO-2-XYLENE: 7°C to 9°C, 4-NITRO-3-XYLENE: 2°C. Immiscible with water. Toxic if swallowed, by skin contact or by inhalation.	1665

UN No. (1)	PSN (2)	Class No. (3)	Subsidiary Risk(s) (4)	Packing Group (5)	Special Provisions (6)	Limited quantities (7a)	Excepted quantities (7b)	Packing			IBC			Portable tanks and bulk containers	EMs (15)	Stowage and Segregation (16)	Properties and Observations (17)	UN No. (18)
								Class or Div. (5)	Subsidiary Risk(s) (4)	Packing Group (5)	Instruct-ions (8)	Provisions (9)	Instruc-tions (10)					
1669	PENTACHLOROETHANE	6.1	P	II	-	100 ml	E4	P001	-	IBC02	-	-	T7	TP2	F-A, S-A	Category A. Clear of living quarters. Colourless liquid. Toxic if swallowed, by skin contact or by inhalation.	1669	
1670	PERCHLOROMETHYL MERCAPTAN	6.1	P	I	354	0	E0	P602	-	-	-	-	T20	TP2	F-A, S-A	Category D. Clear of living quarters. Yellow, oily, volatile liquid evolving irritating vapour ("Tear Gas"). Slowly decomposes in contact with water, producing hydrochloric acid. Reacts with iron or steel, evolving carbon tetrachloride. Corrosive to most metals. Highly toxic if swallowed, by skin contact or by inhalation.	1670	
1671	PHENOL, SOLID	6.1	-	II	279	500 g	E4	P002	-	IBC08	B2 B4	-	T3	TP33	F-A, S-A	Category A. Colourless or white crystals, or crystallized mass. Melting point: -43°C (pure product). Soluble in water. Toxic if swallowed, by skin contact or by vapour inhalation. Highly absorbed through the skin.	1671	
1672	PHENYL CARBYLAMINE CHLORIDE	6.1	-	I	-	0	E5	P602	-	-	-	-	T14	TP2 TP13	F-A, S-A	Category D. Clear of living quarters. Pale yellow, oily liquid with an irritating unpleasant odour. Highly toxic if swallowed, by skin contact or by inhalation.	1672	
1673	PHENYLENEDIAMINES (o-, m-, p-)	6.1	-	III	279	5 kg	E1	P002 LP02	-	IBC08	B3	-	T1	TP33	F-A, S-A	Category A. White crystals or powder. Toxic if swallowed, by skin contact or by dust inhalation. May be carried in the molten state.	1673	
1674	PHENYLMERCURIC ACETATE	6.1	P	II	43	500 g	E4	P002	-	IBC08	B2 B4	-	T3	TP33	F-A, S-A	Category A. Toxic if swallowed, by skin contact or by dust inhalation.	1674	
1677	POTASSIUM ARSENATE	6.1	-	II	-	500 g	E4	P002	-	IBC08	B2 B4	-	T3	TP33	F-A, S-A	Category A. Colourless crystals or white powder. Soluble in water. Toxic if swallowed, by skin contact or by dust inhalation.	1677	
1678	POTASSIUM ARSENITE	6.1	-	II	-	500 g	E4	P002	-	IBC08	B2 B4	-	T3	TP33	F-A, S-A	Category A. White powder. Soluble in water. Toxic if swallowed, by skin contact or by dust inhalation.	1678	
1679	POTASSIUM CUPROCYANIDE	6.1	P	II	-	500 g	E4	P002	-	IBC08	B2 B4	-	T3	TP33	F-A, S-A	Category A. White crystals or powder. Soluble in water. Reacts with acids or acid fumes, evolving hydrogen cyanide, a highly toxic and flammable gas. Toxic if swallowed, by skin contact or by dust inhalation.	1679	
1680	POTASSIUM CYANIDE, SOLID	6.1	P	I	-	0	E5	P002 PP31	IBC07	IBC07	B1	-	T6	TP33	F-A, S-A	Category B. "Separated from" acids. White, deliquescent crystals or lumps. Soluble in water. Reacts with acids or acid fumes, evolving hydrogen cyanide, a highly toxic and flammable gas. Highly toxic if swallowed, by skin contact or by dust inhalation.	1680	
1683	SILVER ARSENITE	6.1	P	II	-	500 g	E4	P002	-	IBC08	B2 B4	-	T3	TP33	F-A, S-A	Category A. Yellow powder. Insoluble in water. Toxic if swallowed, by skin contact or by dust inhalation.	1683	
1684	SILVER CYANIDE	6.1	P	II	-	500 g	E4	P002	-	IBC08	B2 B4	-	T3	TP33	F-A, S-A	Category A. Clear of living quarters. White powder. Insoluble in water. Reacts with acids or acid fumes, evolving hydrogen cyanide, a highly toxic and flammable gas. Toxic if swallowed, by skin contact or by dust inhalation.	1684	
1685	SODIUM ARSENATE	6.1	-	II	-	500 g	E4	P002	-	IBC08	B2 B4	-	T3	TP33	F-A, S-A	Category A. Colourless crystals. Soluble in water. Toxic if swallowed, by skin contact or by dust inhalation.	1685	
1686	SODIUM ARSENITE, AQUEOUS SOLUTION	6.1	-	II	43	100 ml	E4	P001	-	IBC02	-	-	T7	TP2	F-A, S-A	Category A. Colourless liquid. Toxic if swallowed, by skin contact or by inhalation.	1686	
1686	SODIUM ARSENITE, AQUEOUS SOLUTION	6.1	-	III	43 223	5 l	E1	P001 LP01	-	IBC03	-	-	T4	TP2	F-A, S-A	Category A. See entry above.	1686	

**TSFS 2015:66  
Bilaga 1**

UN No. (1)	PSN (2)	Class or Div (3)	Subsidiary Risk(s) (4)	Packing Group (5)	Special Provisions (6)	Limited quantities (7a)	Excepted quantities (7b)	Packaging		IBC		Portable tanks and bulk containers	EMS (15)	Storage and Segregation (16)	Properties and Observations (17)	UN No. (18)	
								Instructions (8)	Provisions (9)	Instructions (10)	Provisions (11)						Tank instructions (12)
	3.1.2	2.0	2.0	2.0, 1.3	3.3	3.4	3.5	4.1, 4	4.1, 4	4.1, 4							
1687	SODIUM AZIDE	6.1	-	II	-	500 g	E4	P002	-	IBC08	B2 B4	-	F-A, S-A	Category A. "Away from" heavy metals or their salts. Reacts with acids to form hydrazic or diazotic compounds which may explode if involved in a fire. Toxic if swallowed, by skin contact or by dust inhalation.		1687	
1688	SODIUM CACODYLATE	6.1	-	II	-	500 g	E4	P002	-	IBC08	B2 B4	T3	TP33	F-A, S-A	Category A. "Separated from" acids. White, deliquescent solid, with a foul odour. Reacts with acids, evolving dimethylarsine, especially in water. Soluble in water. Toxic if swallowed, by skin contact or by dust inhalation.		1688
1689	SODIUM CYANIDE, SOLID	6.1	P	I	-	0	E5	P002	PP31	IBC07	B1	T6	TP33	F-A, S-A	Category B. "Separated from" acids. White, deliquescent crystals or lumps. Soluble in water. Reacts with acids or acid fumes, evolving hydrogen cyanide, a highly toxic and flammable gas. Highly toxic if swallowed, by skin contact or by dust inhalation.		1689
1690	SODIUM FLUORIDE, SOLID	6.1	-	III	-	5 kg	E1	P002 LP02	-	IBC08	B3	T1	TP33	F-A, S-A	Category A. "Separated from" acids. White crystals or powder. React with acids, evolving hydrogen fluoride, a toxic, irritating and corrosive gas, apparent as white fumes. Toxic if swallowed, by skin contact or by inhalation.		1690
1691	STRONTIUM ARSENITE	6.1	-	II	-	500 g	E4	P002	-	IBC08	B2 B4	T3	TP33	F-A, S-A	Category A. White powder. Soluble in water. Toxic if swallowed, by skin contact or by dust inhalation.		1691
1692	STRYCHNINE or STRYCHNINE SALTS	6.1	P	I	43	0	E5	P002	-	IBC07	B1	T6	TP33	F-A, S-A	Category A. White crystals or powder. Strychnine is slightly soluble; the salts are soluble in water. Highly toxic if swallowed, by skin contact or by dust inhalation.		1692
1693	TEAR GAS SUBSTANCE, LIQUID, N.O.S.	6.1	-	I	274	0	E5	P001	PP31	-	-	-	-	F-A, S-A	Category D. Clear of living quarters. "Tear gas substance" is a generic term for substances which, in minute quantities dispersed in air, cause extreme eye irritation and profuse tears. Toxic if swallowed, by skin contact or by inhalation.		1693
1693	TEAR GAS SUBSTANCE, LIQUID, N.O.S.	6.1	-	II	274	0	E4	P001	PP31	IBC02	-	-	-	F-A, S-A	Category D. Clear of living quarters. See entry above.		1693
1694	BROMOBENZYL CYANIDES, LIQUID	6.1	-	I	138	0	E5	P001	PP31	-	-	T14	TP2 TPI3	F-A, S-A	Category D. Keep as cool as reasonably practicable. Clear of living quarters. "Separated from" acids. Volatile liquids, evolving irritating vapour ("Tear Gas"). Melting points: ortho-BROMOBENZYL CYANIDE 1°C. Highly toxic if swallowed, by skin contact or by inhalation.		1694
1695	CHLOROACETONE, STABILIZED	6.1	3/8 P	I	354	0	E0	P602	-	-	-	T20	TP2 TP3 TP35	F-E, S-C	Category D. Clear of living quarters. Segregation as for Class 3 but "Away from" class 4.1.1. Flammable, corrosive, colourless liquid, evolving irritating vapour ("Tear Gas"). Miscible with water. Flashpoint: 25°C c.c. Highly toxic if swallowed, by skin contact or by inhalation.		1695
1697	CHLOROACETOPHENONE, SOLID	6.1	-	II	-	0	E4	P002	-	IBC08	B2 B4	T3	TP33	F-A, S-A	Category D. Keep as cool as reasonably practicable. Clear of living quarters. White crystals evolving irritating vapour ("Tear Gas"). Melting point may be as low as 20°C. Toxic if swallowed, by skin contact or by inhalation.		1697
1698	DIPHENYLAMINE CHLOROARSINE	6.1	P	I	-	0	E5	P002	PP31	-	-	T6	TP33	F-A, S-A	Category D. Clear of living quarters. Volatile, yellow crystals evolving irritating vapour ("Tear Gas"). Highly toxic if swallowed, by skin contact or by inhalation.		1698
1699	DIPHENYLCHLOROARSINE, LIQUID	6.1	P	I	-	0	E5	P001	PP31	-	-	-	-	F-A, S-A	Category D. Clear of living quarters. When pure, colourless liquid. The commercial product may be a dark brown liquid. Volatile liquid evolving an irritating vapour ("Tear Gas"). Highly toxic if swallowed, by skin contact or by inhalation.		1699
1700	TEAR GAS CANDLES	6.1	4.1	II	-	0	E0	P600	-	-	-	-	-	F-A, S-C	Category D. Clear of living quarters. Devices containing tear-producing substances which, in minute quantities dispersed in air, cause extreme eye irritation and profuse tears.		1700
1701	XYLYL BROMIDE, LIQUID	6.1	-	II	-	0	E4	P001	PP31	IBC02	-	T7 TPI3	TP2 TPI3	F-A, S-A	Category D. Clear of living quarters. Colourless liquid, evolving irritating vapour ("Tear Gas"). Toxic if swallowed, by skin contact or by inhalation.		1701
1702	1,1,2,2-TETRACHLOROETHANE	6.1	-	II	-	100 ml	E4	P001	-	IBC02	-	T7	TP2	F-A, S-A	Category A. Clear of living quarters. Colourless liquid with a chloroform-like odour. Toxic if swallowed, by skin contact or by inhalation.		1702

UN No. (1)	PSN (2)	Class or Div (5)	Subsidiary Risk(s) (4)	Packing Group (3)	Special Provisions (6)	Limited quantities (7a)	Excepted quantities (7b)	Packing		IBC	
								Instructions (8)	Provisions (9)	Instructions (10)	Provisions (11)
3.1.2		2.0	2.0	2.0	3.3	3.4	3.5	4.1, 4	4.1, 4		

1704 TETRAETHYL DITHIOPHOSPHATE 6.1 P II 43 100 ml E4 P001 - IBC02 - 1704

1707 THALLIUM COMPOUND, N.O.S. 6.1 P II 43 500 g E4 P002 - IBC08 B2 B4 1707

1708 TOLUIDINES, LIQUID 6.1 - II 279 100 ml E4 P001 - IBC02 - 1708

1709 2,4-TOLUENEDIAMINE, SOLID 6.1 - III - 5 kg E1 P002 LP02 - IBC08 B3 1709

1710 TRICHLOROETHYLENE 6.1 - III - 5 l E1 P001 LP01 - IBC03 - 1710

1711 XYLIDINES, LIQUID 6.1 - II - 100 ml E4 P001 - IBC02 - 1711

1712 ZINC ARSENATE or ZINC ARSENITE or ZINC ARSENATE MIXTURE 6.1 - II - 500 g E4 P002 - IBC08 B2 B4 1712

1713 ZINC CYANIDE 6.1 P I - 0 E5 P002 - IBC07 B1 1713

1714 ZINC PHOSPHIDE 4.3 6.1 I - 0 E0 P403 PP31 - - - 1714

1715 ACETIC ANHYDRIDE 8 3 II - 1 l E2 P001 - IBC02 - 1715

1716 ACETYL BROMIDE 8 - II - 1 l E2 P001 - IBC02 B20 1716

1717 ACETYL CHLORIDE 3 8 II - 1 l E2 P001 - IBC02 B20 1717

1718 BUTYL ACID PHOSPHATE 8 - III - 5 l E1 P001 LP01 - IBC03 - 1718

1719 CAUSTIC ALKALI LIQUID, N.O.S. 8 - II 274 1 l E2 P001 - IBC02 - 1719

1719 CAUSTIC ALKALI LIQUID, N.O.S. 8 - III 223 274 5 l E1 P001 - IBC03 - 1719

1722 ALLYL CHLOROFORMATE 6.1 3/8 I - 0 E5 P001 - - - 1722

Tank instructions (15)	Provisions (14)	EMs (15)	Stowage and Segregation (16)	Properties and Observations (17)	UN No. (18)

T7 TP2 F-A, S-A Category D. Clear of living quarters. Colourless liquid. In the presence of moisture, corrosive to most metals. Toxic if swallowed, by skin contact or by inhalation.

T3 TP33 F-A, S-A Category A. White crystals or powder. Toxic if swallowed, by skin contact or by dust inhalation.

T7 TP2 F-A, S-A Category A. Colourless liquids. Toxic if swallowed, by skin contact or by inhalation.

T1 TP33 F-A, S-A Category A. White crystals or powder. Toxic if swallowed, by skin contact or by inhalation.

T4 TP1 F-A, S-A Category A. Clear of living quarters. Colourless liquid with a chloroform-like odour. When involved in a fire, evolves extremely toxic fumes (phosgene). Toxic if swallowed, by skin contact or by inhalation.

T7 TP2 F-A, S-A Category A. Toxic if swallowed, by skin contact or by inhalation.

T3 TP33 F-A, S-A Category A. Crystalline solid. Insoluble in water. Toxic if swallowed, by skin contact or by dust inhalation.

T6 TP33 F-A, S-A Category A. "Separated from" acids. White crystals or powder. Insoluble in water. Reacts with acids or acid solutions to form highly flammable gas. Highly toxic if swallowed, by skin contact or by dust inhalation.

- F-G, S-N Category E. If under deck, in a contact with water or damp air, evolving phosphine, a spontaneously flammable and highly toxic gas. Reacts violently with oxidizing substances.

T7 TP2 F-E, S-C Category A. Clear of living quarters. Colourless, flammable liquid with an irritating odour. Flashpoint: 51°C.c. Immiscible with water. In the presence of moisture, corrosive to most metals. Vapour irritates mucous membranes.

T8 TP2 F-A, S-B Category C. Clear of living quarters. Colourless liquid. Reacts violently with water, evolving hydrogen bromide, an irritating and corrosive gas apparent as white fumes. In the presence of moisture, highly corrosive to most metals. Vapour irritates mucous membranes.

T8 TP2 F-E, S-C Category B. Clear of living quarters. Colourless liquid. Flashpoint: 5°C.c. Boiling point: 51°C. Reacts violently with water, evolving hydrogen chloride, an irritating and corrosive gas. In the presence of moisture, highly corrosive to most metals. Causes burns to skin, eyes and mucous membranes.

T4 TP1 F-A, S-B Category A. Yellow liquid. Insoluble in water. Mildly corrosive to most metals.

T11 TP2, TP27 F-A, S-B Category A. "Separated from" acids. "Away from" ammonium salts, with ammonium salts, evolving ammonia gas. Causes burns to skin, eyes and mucous membranes.

T7 TP1, TP28 F-A, S-B Category A. "Separated from" acids. "Away from" ammonium salts. See entry above.

T14 TP2, TP13 F-E, S-C Category D. Clear of living quarters. Segregation as for Class 3 but "Away from" class 4.1. Colourless, flammable liquid, extremely irritating odour, causes tears. Flashpoint: 31°C.c. When involved in a fire, evolves toxic gases. In the presence of moisture, corrosive to most metals, highly toxic if swallowed, by skin contact or by inhalation. Causes burns to skin, eyes and mucous membranes.

**TSFS 2015:66  
Bilaga 1**

UN No. (1)	PSN (2)	Class or Div (5)	Subsidiary Risk(s) (4)	Packing Group (3)	Special Provisions (6)	Limited quantities (7a)	Excepted quantities (7b)	Packing			IBC Provisions (11)
								Instruc-tions (8)	Instruc-tions (9)	Instruc-tions (10)	
3.1.2		2.0	2.0	2.0	1.3	3.3	3.4	4.1	4.1	4.1	4.1
		3	8	II	-	1	ℓ	E2	P001	-	IBC02

Tank instructions (15)	Provisions (14)	EMS (15)	Portable tanks and bulk containers	
			T7	TP2 TP3
4.2.5 4.3	4.2.5	5.4.5.2 7.8		

UN No. (16)	Properties and Observations (17)

1723 ALLYL IODIDE Category B. Clear of living quarters. Yellow liquid with an irritating odour. Flashpoint: 55°C. Immiscible with water. Causes burns to skin, eyes and mucous membranes. 1723

1724 ALLYLTRICHLOROSILANE, STABILIZED F-4, S-C Category C. Clear of living quarters. Colourless, flammable liquid with a pungent odour. Flashpoint: 35°C. Reacts violently with hydrogen chloride, an irritating and corrosive gas, apparent as white fumes. When involved in a fire, evolves toxic gases. In the presence of moisture, highly corrosive to most metals. Causes burns to skin, eyes and mucous membranes. 1724

1725 ALUMINIUM BROMIDE, ANHYDROUS F-A, S-B Category A. Clear of living quarters. White to yellowish hygroscopic crystals. Forms corrosive vapours in moist air. Reacts violently with water, evolving heat and hydrogen bromide, an irritating and corrosive gas apparent as white fumes. In the presence of moisture, highly corrosive to most metals. Highly irritating to skin, eyes and mucous membranes. The solid hydrated form of this substance is not subject to the provisions of this Code. 1725

1726 ALUMINIUM CHLORIDE, ANHYDROUS F-A, S-B Category A. Clear of living quarters. White to yellowish hygroscopic crystals. Forms corrosive vapours in moist air. Reacts violently with water, evolving heat and hydrogen chloride, an irritating and corrosive gas apparent as white fumes. In the presence of moisture, highly corrosive to most metals. Highly irritating to skin, eyes and mucous membranes. The solid hydrated form of this substance is not subject to the provisions of this Code. 1726

1727 AMMONIUM HYDROGENDIFLUORIDE, SOLID F-A, S-B Category A. Protected from sources of moisture. White deliquescent crystals. Decomposed by heat or acids, evolving hydrogen fluoride, an irritating and corrosive gas. Reacts violently with water, apparent as white fumes. In the presence of moisture, highly corrosive to glass, other siliceous materials and most metals. Causes burns to skin and mucous membranes. 1727

1728 AMYLTRICHLOROSILANE F-A, S-B Category C. Clear of living quarters. Colourless liquid with a pungent odour. Reacts violently with water, evolving hydrogen chloride, an irritating and corrosive gas apparent as white fumes. When involved in a fire, evolves toxic gases. In the presence of moisture, highly corrosive to most metals. Vapour irritates mucous membranes. 1728

1729 ANISOYL CHLORIDE F-A, S-B Category C. Clear of living quarters. Crystalline powder. Melting point: 22°C. Reacts violently with water, evolving hydrogen chloride, an irritating and corrosive gas apparent as white fumes. In the presence of moisture, highly corrosive to most metals. Vapour irritates mucous membranes. 1729

1730 ANTIMONY PENTACHLORIDE, LIQUID F-A, S-B Category C. Clear of living quarters. Yellow, oily liquid with an offensive odour. May solidify by absorption of moisture, forming a white solid. Reacts violently with water, evolving hydrogen chloride, an irritating and corrosive gas apparent as white fumes. In the presence of moisture, highly corrosive to most metals. Causes burns to skin, eyes and mucous membranes. 1730

1731 ANTIMONY PENTACHLORIDE SOLUTION F-A, S-B Category C. Clear of living quarters. Yellow liquid with an offensive odour. Corrosive to most metals. Causes burns to skin, eyes and mucous membranes. 1731

1732 ANTIMONY PENTACHLORIDE F-A, S-B Category D. Clear of living quarters. Colourless liquid with a pungent odour. When anhydrous, mildly corrosive to glass, other siliceous materials and most metals. Reacts violently with water, evolving hydrogen fluoride, an irritating gas, highly corrosive to glass and other siliceous materials and most metals. Powerful oxidant, may cause fire in contact with readily flammable organic substances. Reacts violently with water, evolving hydrogen chloride, an irritating and corrosive gas. 1732

1736 BENZOYL CHLORIDE F-A, S-B Category C. Clear of living quarters. Colourless liquid, very irritating odour, causes tears. Reacts violently with water, evolving hydrogen chloride, an irritating and corrosive gas apparent as white fumes. In the presence of moisture, highly corrosive to most metals. Vapour irritates mucous membranes. 1736

UN No. (1)	PSN (2)	Class of Div (5)	Secondary Risk(s) (4)	Packing Group (3)	Special Provisions (6)	Limited quantities (7a)	Excepted quantities (7b)	Packing			IBC			Tank instructions (15)	Provisions (14)	Ems (15)	Stowage and Segregation (16)	Properties and Observations (17)	UN No. (18)
								Class (8)	Subsidiary (9)	Instruc-tions (10)	Provisions (11)	Instruc-tions (12)	Provisions (13)						
	3.1.2	2.0	2.0	2.0, 1.3	3.3	3.4	3.5	4.1, 4	4.1, 4	4.1, 4			4.2, 5 4.3	4.2, 5 7.8	54, 5.2 7.8	(16)	7.1 to 7.7		
1737	BENZYL BROMIDE	6.1	8	II	-	0	E4	P001	-	IBC02	B20		TP2 TP1	F-A, 5-B	Category D. Keep as dry as possible. Clear of living quarters.		Colourless liquid with a pungent odour, causes tears. In the presence of moisture, evolves toxic gases. In the presence of moisture, reacts or by inhalation. Causes burns to skin, eyes and mucous membranes.	1737	
1738	BENZYL CHLORIDE	6.1	8	II	-	0	E4	P001	-	IBC02	B20		TP2 TP1	F-A, 5-B	Category D. Keep as dry as possible. Clear of living quarters.		Colourless liquid with a pungent odour. Causes tears. Irritable with moisture, corrosive to most metals. Toxic if swallowed, by skin contact or by vapour inhalation. Causes burns to skin, eyes and mucous membranes.	1738	
1739	BENZYL CHLOROFORMATE	8	-	I	-	0	E0	P001	-	-	-		TP2 TP1	F-A, 5-B	Category D. Clear of living quarters.		Colourless liquid with an irritating odour. Reacts with water. When involved in a fire, evolves toxic gases. In the presence of moisture, highly corrosive to most metals. Causes severe burns to skin, eyes and mucous membranes.	1739	
1740	HYDROGENDIFLORIDES, SOLID, N.O.S.	8	-	II	-	1 kg	E2	P002	-	IBC08	B2 B4		TP3	F-A, 5-B	Category A. Protected from sources of heat. Clear of living quarters.		Crystalline solids. Decomposed by heat or acid, evolving hydrogen fluoride, an extremely irritating and corrosive gas. In the presence of moisture, highly corrosive to most metals. Causes burns to skin, eyes and mucous membranes.	1740	
1740	HYDROGENDIFLORIDES, SOLID, N.O.S.	8	-	III	223	5 kg	E1	P002 LPO2	-	IBC08	B3		TP3	F-A, 5-B	Category A. Protected from sources of heat. Clear of living quarters.		Crystalline solids. Decomposed by heat or acid, evolving hydrogen fluoride, an extremely irritating and corrosive gas. In the presence of moisture, highly corrosive to most metals. Causes burns to skin, eyes and mucous membranes.	1740	
1741	BORON TRICHLORIDE	2.3	8	-	-	0	E0	P200	-	-	-		-	F-C, 5-U	Category D. Clear of living quarters. Protected from sources of heat.		Non-flammable, toxic and corrosive gas. Forms dense white corrosive fumes. In contact with water, evolves hydrogen chloride, an irritating and corrosive gas apparent as white fumes. In the presence of moisture, highly corrosive to most metals. Much heavier than air (2.3). Highly irritating to skin, eyes and mucous membranes.	1741	
1742	BORON TRIFLUORIDE ACETIC ACID COMPLEX, LIQUID	8	-	II	-	1 l	E2	P001	-	IBC02	B20		TP2	F-A, 5-B	Category A.		Highly corrosive to most metals. Causes burns to skin, eyes and mucous membranes.	1742	
1743	BORON TRIFLUORIDE PROPIONIC ACID COMPLEX, LIQUID	8	-	II	-	500 ml	E2	P001	-	IBC02	B20		TP2	F-A, 5-B	Category A.		Highly corrosive to most metals. Causes burns to skin, eyes and mucous membranes.	1743	
1744	BROMINE or BROMINE SOLUTION	8	6.1	I	-	0	E0	P804	-	-	-		TP2 TP10 TP13	F-A, 5-B	Category D. Keep as cool as reasonably practicable. Clear of living quarters. Segregation as for classes 4.1, 5.1 and 7.		Very dark brown, heavy liquid with an extremely irritating odour. Density: 3.1 (pure product, boiling point: 59°C. Powerful oxidant; may cause fire in contact with organic materials such as wood, cotton or straw. Highly corrosive to most metals. Causes burns to skin, eyes and mucous membranes, depending on concentration. Toxic if swallowed; by skin contact or by inhalation. Causes burns to skin, eyes and mucous membranes.	1744	
1745	BROMINE PENTAFLUORIDE	5.1	6.1/8	I	-	0	E0	P200	-	-	-		TP2 TP13	F-A, 5-B	Category D. Protected from sources of heat. Clear of living quarters. Segregation as for class 5.1. Separated from classes 4.1 and 7.		Colourless, flammable liquid with an extremely irritating odour. Boiling point: 40°C. Powerful oxidant; may cause fire in contact with organic material such as wood, cotton or straw. Reacts violently with water, evolving hydrogen fluoride, a toxic, extremely corrosive gas. In contact with acids or acid fumes evolves highly toxic fumes of bromine, fluorine and their compounds. Highly corrosive to most metals. Toxic if swallowed; by skin contact or by inhalation. Causes burns to skin, eyes and mucous membranes.	1745	
1746	BROMINE TRIFLUORIDE	5.1	6.1/8	I	-	0	E0	P200	-	-	-		TP2 TP13	F-A, 5-B	Category D. Protected from sources of heat. Clear of living quarters. Segregation as for class 5.1. Separated from classes 4.1 and 7.		Colourless, heavy liquid with an extremely irritating odour. Powerful oxidant; may cause fire in contact with organic material such as wood, cotton or straw. Reacts violently with water, evolving hydrogen fluoride, a toxic, extremely corrosive gas apparent as white fumes. In contact with acids or acid fumes evolves highly toxic fumes of bromine, fluorine and their compounds. Highly corrosive to most metals. Toxic if swallowed; by skin contact or by inhalation. Causes burns to skin, eyes and mucous membranes.	1746	
1747	BUTYLTRICHLOROSILANE	8	3	II	-	0	E0	P010	-	-	-		TP2 TP3	F-E-C	Category C. Clear of living quarters.		Colourless, flammable liquid with a pungent odour. Flashpoint: 52°C. Reacts violently with water, evolving hydrogen chloride, an irritating and corrosive gas apparent as white fumes. When involved in a fire, evolves toxic gases. In the presence of moisture, highly corrosive to most metals. Vapour irritates mucous membranes.	1747	

UN No. (1)	PSN (2)	Class or Div (5)	Subsidiary Risk(s) (4)	Packing Group (3)	Special Provisions (6)	Limited quantities (7a)	Excepted quantities (7b)	Packing		IBC	
								Instruc-tions (8)	Provisions (9)	Instruc-tions (10)	Provisions (11)
3.1.2		2.0	2.0	2.0	1.3	3.3	3.4	3.5	4.1, 4	4.1, 4	4.1, 4

1748 CALCIUM HYPOCHLORITE, DRY or CALCIUM HYPOCHLORITE MIXTURE, DRY with more than 39% available chlorine (8.8% available oxygen)

Category D. Protected from sources of heat. Cargo transport units shall be shaded from direct sunlight. Packages in cargo transport units shall be stowed so as to allow adequate air circulation throughout the cargo. "Separated from" ammonium compounds, acids, cyanides, hydrogen peroxide and liquid organic substances.

1748

1748 CALCIUM HYPOCHLORITE, DRY or CALCIUM HYPOCHLORITE MIXTURE, DRY with more than 39% available chlorine (8.8% available oxygen)

See entry above.

1748

1749 CHLORINE TRIFLUORIDE

Non-flammable, toxic and corrosive gas. Forms dense, white, corrosive fumes in moist air. Reacts violently with water, evolving hydrogen fluoride, an irritating and corrosive gas apparent as white fumes. Corrosive to glass and to most metals. Powerful oxidizing agent which may cause fires with organic materials. Heavier than air. Highly irritating to skin, eyes and mucous membranes.

1749

1750 CHLOROACETIC ACID SOLUTION

Colourless liquid. Corrosive to most metals. Toxic if swallowed, by skin contact or by inhalation. Causes burns to skin, eyes and mucous membranes.

1750

1751 CHLOROACETIC ACID, SOLID

Colourless, very deliquescent crystals. Melting point may be as low as 50°C. In the presence of moisture, corrosive to most metals. Toxic if swallowed, by skin contact or by dust inhalation. Causes burns to skin, eyes and mucous membranes.

1751

1752 CHLOROACETYL CHLORIDE

Colourless liquid, with extremely irritating odour, causing tears. Reacts violently with water, evolving hydrogen chloride, an irritating and corrosive to most metals. Highly toxic if swallowed, by skin contact or by inhalation. Causes burns to skin, eyes, and mucous membranes.

1752

1753 CHLOROPHENYL TRICHLOROSULFANE

Colourless liquid with a pungent odour. Reacts violently with water, evolving hydrogen chloride, an irritating and corrosive gas apparent as white fumes. When involved in a fire, evolves toxic gases. In the presence of moisture, highly corrosive to most metals. Irritating to skin, eyes and mucous membranes.

1753

1754 CHLOROSULFONIC ACID (with or without sulphur trioxide)

Colourless liquid with a pungent odour. Reacts violently with water, evolving sulfur dioxide, an irritating and corrosive gas apparent as white fumes. In the presence of moisture, highly corrosive to most metals. Causes severe burns to skin, eyes and mucous membranes.

1754

1755 CHROMIC ACID SOLUTION

Orange liquid. Powerful oxidant. May cause fire in contact with organic materials such as wood, cotton or straw. Highly corrosive to most metals. "Away from" classes 4.1, 5.1 and 7.

1755

1755 CHROMIC ACID SOLUTION

See entry above.

1755

1756 CHROMIC FLUORIDE, SOLID

Green or violet crystals. Slightly soluble in water. Reacts with strong acids, forming hydrogen fluoride and toxic fumes. Causes burns to skin, eyes and mucous membranes.

1756

1757 CHROMIC FLUORIDE SOLUTION

Green liquid. Reacts with strong acids, evolving hydrogen fluoride, an extremely corrosive gas. Causes burns to skin, eyes and mucous membranes.

1757

Tank instructions (15)	Provisions (14)	EMs (15)	Stowage and Segregation (16)	Properties and Observations (17)	UN No. (18)
4.2.5 4.3	4.2.5	54.5.2 7.8	7.1 to 7.7	(17)	

Category D. Protected from sources of heat. Cargo transport units shall be shaded from direct sunlight. Packages in cargo transport units shall be stowed so as to allow adequate air circulation throughout the cargo. "Separated from" ammonium compounds, acids, cyanides, hydrogen peroxide and liquid organic substances.

1748

Category D. Protected from sources of heat. Cargo transport units shall be shaded from direct sunlight. Packages in cargo transport units shall be stowed so as to allow adequate air circulation throughout the cargo. "Separated from" ammonium compounds, acids, cyanides, hydrogen peroxide and liquid organic substances.

1748

Category D. Clear of living quarters. Segregation as for class 5.1 but "Separated from" class 7.

1749

Category C. Clear of living quarters.

1750

Category C. Clear of living quarters.

1751

Category D. Clear of living quarters.

1752

Category C. Clear of living quarters.

1753

Category C. Clear of living quarters.

1754

Category C. Clear of living quarters. Segregation as for class 5.1 but "Away from" classes 4.1, 5.1 and 7.

1755

Category A. "Separated from" acids.

1756

Category A.

1757



UN No. (1)	PSN (2)	Class or Div (3)	Subsidiary Risk(s) (4)	Packing Group (5)	Special Provisions (6)	Limited quantities (7a)	Excepted quantities (7b)	Packing			IBC				
								Class (8)	Subsidiary Risk(s) (9)	Provisions (10)	Class (11)	Subsidiary Risk(s) (12)	Provisions (13)		
3.1.2		2.0	2.0	2.0	3.3	3.4	3.5	4.1.4	4.1.4	4.1.4	4.1.4				

UN No. (15)	Provisions (14)	EMs (15)	Stowage and Segregation (16)	Properties and Observations (17)
4.2.5 4.3	4.2.5	5.4.3.2 7.8	7.1 to 7.7	

1758	CHROMIUM OXYCHLORIDE	8	-	I	-	0	EO	P001	-	-	-	-	T10	TP2	F-A, S-B	Category C. Clear of living quarters. Dark red liquid. Reacts violently with water, evolving hydrogen chloride gas. Oxidant. May cause fire in contact with organic materials such as wood, cotton or straw. Highly corrosive to most metals. In the presence of moisture, highly corrosive to most metals. Causes severe burns to skin, eyes and mucous membranes.	1758
1759	CORROSIVE SOLID, N.O.S.	8	-	I	274	0	EO	P002	-	IBC07	B1		T6	TP33	F-A, S-B	Category B. Causes burns to skin, eyes and mucous membranes.	1759
1759	CORROSIVE SOLID, N.O.S.	8	-	II	274	1 kg	E2	P002	-	IBC08	B2 B4		T3	TP33	F-A, S-B	Category A. See entry above.	1759
1759	CORROSIVE SOLID, N.O.S.	8	-	III	223 274	5 kg	E1	P002 LP02	-	IBC08	B3		T1	TP33	F-A, S-B	Category A. See entry above.	1759
1760	CORROSIVE LIQUID, N.O.S.	8	-	I	274	0	EO	P001	-	-	-		T14	TP2 TP27	F-A, S-B	Category B. Clear of living quarters. Causes burns to skin, eyes and mucous membranes.	1760
1760	CORROSIVE LIQUID, N.O.S.	8	-	II	274	1 ℓ	E2	P001	-	IBC02	-		T11	TP2 TP27	F-A, S-B	Category B. Clear of living quarters. See entry above.	1760
1760	CORROSIVE LIQUID, N.O.S.	8	-	III	223 274	5 ℓ	E1	P001 LP01	-	IBC03	-		T7	TP1 TP28	F-A, S-B	Category A. Clear of living quarters. See entry above.	1760
1761	CUPRIETHYLENEDIAMINE SOLUTION	8	6.1 P	II	-	1 ℓ	E2	P001	-	IBC02	-		T7	TP2	F-A, S-B	Category A. Dark purple liquid with an ammonia-like odour. Corrosive to copper, aluminium, zinc and tin. Toxic if swallowed, by skin contact or by inhalation. Causes burns to skin, eyes and mucous membranes.	1761
1761	CUPRIETHYLENEDIAMINE SOLUTION	8	6.1 P	III	223	5 ℓ	E1	P001	-	IBC03	-		T7	TP1 TP28	F-A, S-B	Category A. See entry above.	1761
1762	CYCLOHEXYLTRICHLOROSILANE	8	-	II	-	0	EO	P010	-	-	-		T10	TP2 TP7 TP13	F-A, S-B	Category C. Clear of living quarters. Colourless liquid with a pungent odour. Reacts violently with water, evolving hydrogen chloride, an irritating and corrosive gas apparent as white fumes. When involved in a fire, evolves toxic gases. In the presence of moisture, highly corrosive to most metals. Causes burns to skin, eyes and mucous membranes.	1762
1763	CYCLOHEXYLTRICHLOROSILANE	8	-	II	-	0	EO	P010	-	-	-		T10	TP2 TP7 TP13	F-A, S-B	Category C. Clear of living quarters. Colourless liquid with a pungent odour. Reacts violently with water, evolving hydrogen chloride, an irritating and corrosive gas apparent as white fumes. When involved in a fire, evolves toxic gases. In the presence of moisture, highly corrosive to most metals. Vapour irritates mucous membranes.	1763
1764	DICHLOROACETIC ACID	8	-	II	-	1 ℓ	E2	P001	-	IBC02	B20		T8	TP2	F-A, S-B	Category A. Colourless liquid. Melting point: -4°C. Highly corrosive to most metals. Causes burns to skin, eyes and mucous membranes.	1764
1765	DICHLOROACETYL CHLORIDE	8	-	II	-	1 ℓ	E2	P001	-	IBC02	-		T7	TP2	F-A, S-B	Category D. Clear of living quarters. Colourless liquid with an extremely irritating odour, causing tears. Reacts violently with water, evolving hydrogen chloride, an irritating and corrosive gas apparent as white fumes. In the presence of moisture, highly corrosive to most metals. Causes burns to skin, eyes and mucous membranes.	1765
1766	DICHLOROPHENYLTRICHLOROSILANE	8	-	II	-	0	EO	P010	-	-	-		T10	TP2 TP7 TP13	F-A, S-B	Category C. Clear of living quarters. Colourless liquid with a pungent odour. Reacts violently with water, evolving hydrogen chloride, an irritating and corrosive gas apparent as white fumes. When involved in a fire, evolves toxic gases. In the presence of moisture, highly corrosive to most metals, (irritating to skin, eyes and mucous membranes).	1766

**TSFS 2015:66  
Bilaga 1**

UN No. (1)	PSN (2)	Class of Div (3)	Subsidiary Risk(s) (4)	Packing Group (5)	Special Provisions (6)	Limited quantities (7a)	Excepted quantities (7b)	Packing			IBC			UN No. (18)			
								Class (8)	Packing (9)	Instructions (10)	Provisions (11)	Instructions (12)	Provisions (13)		Instructions (14)	Provisions (15)	
	3.1.2	2.0	2.0	2.0	2.0	3.3	3.4	3.5	4.1.4	4.1.4	4.1.4	4.1.4					
1767	DIETHYLCHLORSILANE	8	3	II	-	0	EO	P010	-	-	-	-	T10 TP2 TP3	F-E, S-C Category C. Clear of living quarters.	Colourless, flammable liquid with a pungent odour. Flashpoint: 25 °C. Corrosive to skin, eyes and mucous membranes. Causes severe burns to skin, eyes and mucous membranes. Harmful if swallowed.	1767	
1768	DIFLUOROPHOSPHORIC ACID, ANHYDROUS	8	-	II	-	1 ℓ	E2	P001	-	IBC02	B20	-	T8	TP2	F-A, S-B Category A. Clear of living quarters.	Colourless liquid. In the presence of moisture, highly corrosive to glass, other siliceous materials. Harmful if swallowed.	1768
1769	DIPHENYLCHLORSILANE	8	-	II	-	0	EO	P010	-	-	-	-	T10 TP2 TP3	F-A, S-B Category C. Clear of living quarters.	Colourless liquid with a pungent odour. Reacts violently with water, evolving hydrogen chloride, an irritating and corrosive gas apparent as white fumes. When involved in a fire, evolves toxic gases. In the presence of moisture, highly corrosive to most metals. Vapour irritates mucous membranes.	1769	
1770	DIPHENYLMETHYL BROMIDE	8	-	II	-	1 kg	E2	P002	-	IBC08	B2 B4	-	T3	TP33	F-A, S-B Category D. Clear of living quarters.	Solid with an irritating odour. Causes tears. Melting point: 45°C. In the presence of moisture, corrosive to most metals. Vapour irritates mucous membranes.	1770
1771	DODECYLTRICHLORSILANE	8	-	II	-	0	EO	P010	-	-	-	-	T10 TP2 TP3	F-A, S-B Category C. Clear of living quarters.	Colourless liquid with a pungent odour. Reacts violently with water, evolving hydrogen chloride, an irritating and corrosive gas apparent as white fumes. When involved in a fire, evolves toxic gases. In the presence of moisture, highly corrosive to most metals. Causes burns to skin, eyes and mucous membranes.	1771	
1773	FERRIC CHLORIDE, ANHYDROUS	8	-	III	-	5 kg	E1	P002 LP02	-	IBC08	B3	-	T1	TP33	F-A, S-B Category A.	brown solid. In the presence of moisture, highly corrosive to most metals. The provisions of this Code should not apply to the solid hydrated form.	1773
1774	FIRE EXTINGUISHER CHARGES, corrosive liquid	8	-	II	-	1 ℓ	EO	P001	PP4	-	-	-	-	F-A, S-B Category A.	Usually, diluted sulphuric acid in small glass receptacles.	1774	
1775	FLUORBORIC ACID	8	-	II	-	1 ℓ	E2	P001	-	IBC02	-	-	T7	TP2	F-A, S-B Category A.	Colourless, clear liquid. Corrosive to most metals. May cause severe burns to skin, eyes and mucous membranes if containing free hydrofluoric acid.	1775
1776	FLUOROPHOSPHORIC ACID, ANHYDROUS	8	-	II	-	1 ℓ	E2	P001	-	IBC02	B20	-	T8	TP2	F-A, S-B Category A.	Colourless liquid. In the presence of moisture, highly corrosive to glass, other siliceous materials and most metals. Causes burns to skin, eyes and mucous membranes.	1776
1777	FLUORSULPHONIC ACID	8	-	I	-	0	EO	P001	-	-	-	-	T10	TP2	F-A, S-B Category D. Clear of living quarters.	Colourless liquid with a pungent odour. Reacts violently with water, evolving hydrogen fluoride, an extremely irritating and corrosive gas apparent as white fumes. When involved in a fire, evolves toxic gases. In the presence of moisture, highly corrosive to glass, other siliceous materials and most metals. Causes severe burns to skin, eyes and mucous membranes.	1777
1778	FLUORSILICIC ACID	8	-	II	-	1 ℓ	E2	P001	-	IBC02	B20	-	T8	TP2	F-A, S-B Category A.	Colourless liquid. Highly corrosive to most metals. May cause severe burns to skin, eyes and mucous membranes if containing free hydrofluoric acid.	1778
1779	FORMIC ACID with more than 85% acid, by mass	8	3	II	-	1 ℓ	E2	P001	-	IBC02	-	-	T7	TP2	F-E, S-C Category A. Clear of living quarters.	Colourless, flammable liquid with a pungent odour. Pure, FORMIC ACID; flashpoint 42°C. Corrosive to most metals. Causes burns to skin, eyes and mucous membranes.	1779
1780	FUMARYL CHLORIDE	8	-	II	-	1 ℓ	E2	P001	-	IBC02	-	-	T7	TP2	F-A, S-B Category C. Clear of living quarters.	Yellow liquid. Reacts violently with water, evolving hydrogen chloride, an irritating and corrosive gas apparent as white fumes. In the presence of moisture, highly corrosive to most metals. Causes burns to skin, eyes and mucous membranes.	1780
1781	HEXADECYLTRICHLORSILANE	8	-	II	-	0	EO	P010	-	-	-	-	T10 TP2 TP3	F-A, S-B Category C. Clear of living quarters.	Colourless liquid with a pungent odour. Reacts violently with water, evolving hydrogen chloride, an irritating and corrosive gas apparent as white fumes. When involved in a fire, evolves toxic gases. In the presence of moisture, highly corrosive to most metals. Vapour irritates mucous membranes.	1781	
1782	HEXAFLUOROPHOSPHORIC ACID	8	-	II	-	1 ℓ	E2	P001	-	IBC02	B20	-	T8	TP2	F-A, S-B Category A.	Colourless liquid. In the presence of moisture, highly corrosive to glass, other siliceous materials and most metals. Causes burns to skin, eyes and mucous membranes. Harmful if swallowed.	1782

UN No. (1)	PSN (2)	Class No. (3)	Subsidiary Risk(s) (4)	Packing Group (5)	Special Provisions (6)	Limited quantities (7a)	Excepted quantities (7b)	Packing		IBC		Portable tanks and bulk containers		EMs (15)	Storage and Segregation (16)	Properties and Observations (17)	UN No. (18)
								Institutions (8)	Provisions (9)	Institutions (10)	Provisions (11)	Tank instructions (12)	Provisions (13)				
1783	HEXAMETHYLENEDIAMINE SOLUTION	8	-	II	-	1 ℓ	E2	P001	-	IBC02	-	T7	TP2	F-A, S-B	Category A	Colourless liquid. Causes burns to skin, eyes and mucous membranes.	1783
1783	HEXAMETHYLENEDIAMINE SOLUTION	8	-	III	223	5 ℓ	E1	P001 LP01	-	IBC03	-	T4	TP1	F-A, S-B	Category A	See entry above.	1783
1784	HEXYLTRICHLOROSLANE	8	-	II	-	0	E0	P010	-	-	-	T10	TP2 TP7 TP13	F-A, S-B	Category C	Colourless liquid with a pungent odour. Reacts violently with water, evolving hydrogen chloride, an irritating and corrosive gas apparent as white fumes. When mixed with water, it evolves toxic gases. In the presence of moisture, highly corrosive to most metals. Causes burns to skin, eyes and mucous membranes.	1784
1786	HYDROFLUORIC ACID AND SULPHURIC ACID MIXTURE	8	6.1	I	-	0	E0	P001	-	-	-	T10	TP2 TP13	F-A, S-B	Category D	Clear of living quarters. Colourless syrupy liquid with a pungent odour. Mixture consists of between 70% and 80% by mass of acids and contains not less than 25% by mass of hydrofluoric acid. Reacts violently with water, developing heat. Highly corrosive to glass, other siliceous materials and most metals. Toxic if inhaled. Causes severe burns to skin and mucous membranes.	1786
1787	HYDRIODIC ACID	8	-	II	-	1 ℓ	E2	P001	-	IBC02	-	T7	TP2	F-A, S-B	Category C	Colourless liquid. An aqueous solution of the gas hydrogen iodide. Highly corrosive to most metals. Causes burns to skin, eyes and mucous membranes.	1787
1787	HYDRIODIC ACID	8	-	III	223	5 ℓ	E1	P001 LP01	-	IBC03	-	T4	TP1	F-A, S-B	Category C	See entry above.	1787
1788	HYDROBROMIC ACID	8	-	II	-	1 ℓ	E2	P001	-	IBC02	-	T7	TP2	F-A, S-B	Category C	Colourless liquid. An aqueous solution of the gas hydrogen bromide. Highly corrosive to most metals. Causes burns to skin, eyes and mucous membranes.	1788
1788	HYDROBROMIC ACID	8	-	III	223	5 ℓ	E1	P001 LP01	-	IBC03	-	T4	TP1	F-A, S-B	Category C	See entry above.	1788
1789	HYDROCHLORIC ACID	8	-	II	-	1 ℓ	E2	P001	-	IBC02	B20	T8	TP2	F-A, S-B	Category C	Colourless liquid. An aqueous solution of the gas hydrogen chloride. Highly corrosive to most metals. Causes burns to skin, eyes and mucous membranes.	1789
1789	HYDROCHLORIC ACID	8	-	III	223	5 ℓ	E1	P001 LP01	-	IBC03	-	T4	TP1	F-A, S-B	Category C	See entry above.	1789
1790	HYDROFLUORIC ACID solution, with more than 60% hydrogen fluoride	8	6.1	I	-	0	E0	P802 PB81	-	-	-	T10	TP2 TP13	F-A, S-B	Category D	Keep as cool as reasonably practicable. Clear of living quarters. Colourless liquid with a irritating odour. Highly corrosive to glass, other siliceous materials and most metals. Toxic if swallowed, by skin contact or by inhalation. Both the liquid and its fumes cause severe burns to skin, eyes and mucous membranes.	1790
1790	HYDROFLUORIC ACID solution, with not more than 60% hydrogen fluoride	8	6.1	II	-	1 ℓ	E2	P001	P81	IBC02	B20	T8	TP2	F-A, S-B	Category D	Keep as cool as reasonably practicable. Clear of living quarters.	1790
1791	HYPOCHLORITE SOLUTION	8	-	II	-	1 ℓ	E2	P001	P10	IBC02	B5	T7	TP2 TP24	F-A, S-B	Category B	Away from acids. Liquid with chlorine odour. In contact with acids, evolves very irritating and corrosive gases. Mildly corrosive to most metals. Causes burns to skin, eyes and mucous membranes.	1791
1791	HYPOCHLORITE SOLUTION	8	-	III	223	5 ℓ	E1	P001 LP01	-	IBC03	-	T4	TP2 TP24	F-A, S-B	Category B	Away from acids. See entry above.	1791
1792	IODINE MONOCHLORIDE SOLID	8	-	II	-	1 kg	E2	P002	-	IBC08	B2 B4	T7	TP2	F-A, S-B	Category D	Clear of living quarters. Red, brown or black crystals. Reacts violently with water, evolving hydrogen chloride gas. Causes severe burns to skin, eyes and mucous membranes. May cause fire in contact with organic materials such as wood, cotton or straw. In the presence of moisture, highly corrosive to most metals. Vapour irritates mucous membranes.	1792

**TSFS 2015:66  
Bilaga 1**

UN No. (1)	PSN (2)	Class No. of Div (3)	Subsidiary Risk(s) (4)	Packing Group (5)	Special Provisions (6)	Limited quantities (7a)	Excepted quantities (7b)	Packing		IBC		Portable tanks and bulk containers	EMs (15)	Stowage and Segregation (16)	Properties and Observations (17)	UN No. (18)	
								Instruc-tions (8)	Provisions (9)	Instruc-tions (10)	Provisions (11)						Tank instructions (12)
1793	ISOPROPYLACID PHOSPHATE	8	-	III	-	5 ℓ	E1	P001 LP01	-	IBC02	-	T4	TP1	F-A, S-B	Category A.	Only liquid. Mildly corrosive to most metals.	1793
1794	LEAD SULPHATE with more than 3% free acid	8	-	II	-	1 kg	E2	P002	-	IBC08	B2 B4	T3	TP33	F-A, S-B	Category A.	May be dry solid or slurry. Corrosive to most metals. Harmful if swallowed.	1794
1796	NITRATING ACID MIXTURE with more than 50% nitric acid	8	5.1	I	-	0	E0	P001	-	-	-	T10	TP2 TP13	F-A, S-Q	Category D. Clear of living quarters. *Separated from class 4.1.	Mixture of concentrated nitric and sulphuric acids. Oxidant. May cause fire in contact with organic materials such as wood, cotton or straw, developing highly toxic gas (brown fumes). Highly corrosive to most metals. Causes severe burns to skin, eyes and mucous membranes.	1796
1796	NITRATING ACID MIXTURE with not more than 50% nitric acid	8	-	II	-	1 ℓ	E2	P001	-	IBC02	B20	T8	TP2 TP13	F-A, S-B	Category D. Clear of living quarters. See entry above.		1796
1798	NITROHYDROCHLORIC ACID	8	-	I	-	0	E0	P802	-	-	-	T10	TP2 TP13	F-A, S-B	Category D. Clear of living quarters. Segregation as for Class 5.1, but *Separated from classes 4.1, 5.1 and 7.	Yellow liquid, a mixture of nitric acid and hydrochloric acid, usually in the proportion of 1:3. Powerful oxidant; may cause fire in contact with organic materials such as wood, cotton or straw, evolving suffocating and highly toxic gases. Highly corrosive to all metals. Causes severe burns to skin, eyes and mucous membranes.	1798
1799	NONYLTRICHLOROSILANE	8	-	II	-	0	E0	P010	-	-	-	T10	TP2 TP13	F-A, S-B	Category C. Clear of living quarters.	Colourless liquid with a pungent odour. Reacts violently with water, evolving hydrogen chloride, an irritating and corrosive gas apparent as white fumes. When involved in a fire, evolves toxic gases. In the presence of moisture, highly corrosive to most metals. Causes burns to skin, eyes and mucous membranes.	1799
1800	OCTADECYLTRICHLOROSILANE	8	-	II	-	0	E0	P010	-	-	-	T10	TP2 TP7 TP13	F-A, S-B	Category C. Clear of living quarters.	Colourless liquid with a pungent odour. Reacts violently with water, evolving hydrogen chloride, an irritating and corrosive gas apparent as white fumes. When involved in a fire, evolves toxic gases. In the presence of moisture, highly corrosive to most metals. Vapour irritates mucous membranes.	1800
1801	OCTYLTRICHLOROSILANE	8	-	II	-	0	E0	P010	-	-	-	T10	TP2 TP13	F-A, S-B	Category C. Clear of living quarters.	Colourless liquid with a pungent odour. Reacts violently with water, evolving hydrogen chloride, an irritating and corrosive gas apparent as white fumes. When involved in a fire, evolves toxic gases. In the presence of moisture, highly corrosive to most metals. Vapour irritates mucous membranes.	1801
1802	PERCHLORIC ACID with not more than 50% acid, by mass	8	5.1	II	-	1 ℓ	E2	P001	-	IBC02	-	T7	TP2	F-H, S-Q	Category C. *Separated from class 4.1.	Colourless liquid. Oxidant. Highly corrosive to most metals.	1802
1803	PHENOLSULPHONIC ACID, LIQUID	8	-	II	-	1 ℓ	E2	P001	-	IBC02	-	T7	TP2	F-A, S-B	Category C. For metal drums, category B.	Yellow, oily liquid. Corrosive to most metals.	1803
1804	PHENYLTRICHLOROSILANE	8	-	II	-	0	E0	P010	-	-	-	T10	TP2 TP7 TP13	F-A, S-B	Category C. Clear of living quarters.	Colourless liquid with a pungent odour. Reacts violently with water, evolving hydrogen chloride, an irritating and corrosive gas apparent as white fumes. When involved in a fire, evolves toxic gases. In the presence of moisture, highly corrosive to most metals. Vapour irritates mucous membranes.	1804
1805	PHOSPHORIC ACID SOLUTION	8	-	III	22.3	5 ℓ	E1	P001 LP01	-	IBC03	-	T4	TP1	F-A, S-B	Category A.	Miscible in water. Mildly corrosive to most metals.	1805
1806	PHOSPHORUS PENTACHLORIDE	8	-	II	-	1 kg	E2	P002	-	IBC08	B2 B4	T3	TP33	F-A, S-B	Category C. Clear of living quarters. Segregation as for class 5.1, but *Separated from classes 4.1, 5.1 and 7.	Colourless, crystalline powder. Reacts violently with water, evolving hydrogen chloride, an irritating and corrosive gas apparent as white fumes. When involved in a fire, evolves toxic gases. In the presence of moisture, highly corrosive to most metals.	1806
1807	PHOSPHORUS PENTOXIDE	8	-	II	-	1 kg	E2	P002	-	IBC08	B2 B4	T3	TP33	F-A, S-B	Category A.	Crystalline powder, very deliquescent. Reacts violently with water and organic materials such as wood, cotton or straw, generating heat. In the presence of moisture, mildly corrosive to most metals.	1807

UN No. (1)	PSN (2)	Class No. (3)	Subsidiary Risk(s) (4)	Packing Group (5)	Special Provisions (6)	Limited quantities (7a)	Excepted quantities (7b)	Packing			IBC	
								Instruc-tions (8)	Provisions (9)	Instruc-tions (10)	Provisions (11)	
3.1.2		2.0	2.0	2.0, 1.3	3.3	3.4	3.5	4.1, 4	4.1, 4			
1808	PHOSPHORUS TRIBROMIDE	8	-	II	-	1 ℓ	E2	P001	-	IBC02	-	
1809	PHOSPHORUS TRICHLORIDE	6.1	8	I	354	0	E0	P602	-	-	-	
1810	PHOSPHORUS OXYCHLORIDE	6.1	8	I	354	0	E0	P602	-	-	-	
1811	POTASSIUM HYDROGEN DIFLUORIDE, SOLID	8	6.1	II	-	1 kg	E2	P002	-	IBC08	B2 B4	
1812	POTASSIUM FLUORIDE, SOLID	6.1	-	III	-	5 kg	E1	P002 LP02	-	IBC08	B3	
1813	POTASSIUM HYDROXIDE, SOLID	8	-	II	-	1 kg	E2	P002	-	IBC08	B2 B4	
1814	POTASSIUM HYDROXIDE SOLUTION	8	-	II	-	1 ℓ	E2	P001	-	IBC02	-	
1814	POTASSIUM HYDROXIDE SOLUTION	8	-	III	223	5 ℓ	E1	P001 LP01	-	IBC03	-	
1815	PROPIONYL CHLORIDE	3	8	II	-	1 ℓ	E2	P001	-	IBC02	-	
1816	PROPYLTRICHLOROSILANE	8	3	II	-	0	E0	P010	-	-	-	
1817	PROSULPHURYL CHLORIDE	8	-	II	-	1 ℓ	E2	P001	-	IBC02	-	
1818	SILICON TETRACHLORIDE	8	-	II	-	0	E0	P010	-	-	-	
1819	SODIUM ALUMINATE SOLUTION	8	-	II	-	1 ℓ	E2	P001	-	IBC02	-	
1819	SODIUM ALUMINATE SOLUTION	8	-	III	223	5 ℓ	E1	P001 LP01	-	IBC03	-	
1823	SODIUM HYDROXIDE, SOLID	8	-	II	-	1 kg	E2	P002	-	IBC08	B2 B4	

UN No. (16)	Properties and Observations (17)	Portable tanks and bulk containers		Stowage and Segregation (16)	Ems (15)	Provisions (14)	Tank instructions (15)	UN No. (16)
		Tank instructions (15)	Provisions (14)					
		4.2.5	4.2.5	7.1 to 7.7	54.5.2	(14)	(15)	(17)
		4.3	7.8					
1808	Colourless liquid with a pungent odour. Reacts violently with water, white fumes. In the presence of moisture, highly corrosive to most metals. Causes burns to skin, eyes and mucous membranes.	T7	TP2	Category C. Clear of living quarters.	F-A, S-B			
1809	Colourless liquid with a pungent odour. Reacts violently with water, evolving hydrogen chloride, an irritating and corrosive gas apparent as white fumes. In the presence of moisture, highly corrosive to most metals. Highly toxic if swallowed, by skin contact or by inhalation. Causes burns to skin, eyes and mucous membranes.	T20	TP2 TP3 TP5	Category D. Clear of living quarters.	F-A, S-B			
1810	Colourless liquid with a pungent odour. Reacts violently with water, evolving hydrogen chloride, an irritating and corrosive gas apparent as white fumes. In the presence of moisture, highly corrosive to most metals. Causes burns to skin, eyes and mucous membranes. Highly toxic if swallowed, by skin contact or by inhalation.	T20	TP2 TP3 TP7	Category D. Clear of living quarters.	F-A, S-B			
1811	White crystalline solid. Decomposed by heat or acids, evolving hydrogen chloride, an irritating and corrosive gas. In the presence of moisture, highly corrosive to glass, other siliceous materials and most metals. Toxic if swallowed, by skin contact or by inhalation. Causes burns to skin, eyes and mucous membranes.	T3	TP33	Category A. Protected from sources of heat and moisture. Clear of living quarters. Separated from acids.	F-A, S-B			
1812	White, deliquescent crystals or powder. Decomposed by acids, evolving hydrogen fluoride, irritating and corrosive gas. Toxic if swallowed, by skin contact or by inhalation.	T1	TP33	Category A. "Separated from" acids.	F-A, S-A			
1813	White pellets, flakes, lumps or solid blocks, deliquescent. Reacts with ammonium salts, evolving ammonia gas. In the presence of moisture, corrosive to aluminium, zinc and tin. Causes burns to skin, eyes and mucous membranes. Reacts violently with acids.	T3	TP33	Category A. "Separated from" acids.	F-A, S-B			
1814	Colourless liquid. Reacts with ammonium salts, evolving ammonia gas. Corrosive to aluminium, zinc and tin. Causes burns to skin, eyes and mucous membranes. Reacts violently with acids.	T7	TP2	Category A. "Separated from" acids.	F-A, S-B			
1814	See entry above.	T4	TP1	Category A. "Separated from" acids.	F-A, S-B			
1815	Colourless liquid. Flashpoint: 12°C c.c. Reacts violently with water, evolving hydrogen chloride, an irritating and corrosive gas, apparent as white fumes. In the presence of moisture, highly corrosive to most metals. Causes burns to skin, eyes and mucous membranes.	T7	TP1	Category B. Clear of living quarters.	F-E, S-C			
1816	Colourless, flammable liquid, with a pungent odour. Flashpoint: 38°C c.c. Reacts violently with water, evolving hydrogen chloride, an irritating and corrosive gas. In the presence of moisture, highly corrosive to most metals. Vapour irritates mucous membranes.	T10	TP2 TP3	Category C. Clear of living quarters.	F-E, S-C			
1817	Colourless liquid with a pungent odour. Reacts violently with water, evolving hydrogen chloride, an irritating and corrosive to most metals. Vapour irritates mucous membranes.	T8	TP2	Category C. Clear of living quarters.	F-A, S-B			
1818	Colourless, extremely mobile liquid with a suffocating odour. Reacts violently with water, evolving hydrogen chloride, an irritating and corrosive gas apparent as white fumes. In the presence of moisture, highly corrosive to most metals. Vapour irritates mucous membranes.	T10	TP2 TP7 TP13	Category C. Clear of living quarters. See 7.2.6.3.2.	F-A, S-B			
1819	Colourless liquid. Reacts with ammonium salts, evolving ammonia gas. Corrosive to aluminium, zinc and tin. Causes burns to skin, eyes and mucous membranes. Reacts violently with acids.	T7	TP2	Category A. "Separated from" acids.	F-A, S-B			
1819	See entry above.	T4	TP1	Category A. "Separated from" acids.	F-A, S-B			
1823	White pellets, flakes, lumps or solid blocks, deliquescent. Reacts with ammonium salts, evolving ammonia gas. In the presence of moisture, corrosive to aluminium, zinc and tin. Causes burns to skin, eyes and mucous membranes. Reacts violently with acids.	T3	TP33	Category A. "Separated from" acids.	F-A, S-B			

**TSFS 2015:66  
Bilaga 1**

UN No. (1)	PSN (2)	Class or Div (3)	Subsidiary Risk(s) (4)	Packing Group (5)	Special Provisions (6)	Limited quantities (7a)	Excepted quantities (7b)	Packing		IBC	
								Instruc-tions (8)	Provisions (9)	Instruc-tions (10)	Provisions (11)
3.1.2		2.0	2.0	2.0, 1.3	3.3	3.4	3.5	4.1, 4	4.1, 4	4.1, 4	

UN No. (16)	Properties and Observations (17)	Portable tanks and bulk containers		Stowage and Segregation (16)	UN No. (16)
		Tank instructions (15)	Provisions (14)		
		4.2.5 4.3	4.2.5 7.8	7.1 to 7.7	

1824 SODIUM HYDROXIDE SOLUTION  
8 - - II - - 1 ℓ E2 P001 - IBC02 -

Colourless liquid. Corrosive to aluminium, zinc and tin. Reacts with acids. Causes severe burns to skin, eyes and mucous membranes. Reacts violently with acids.

1824 SODIUM HYDROXIDE SOLUTION  
8 - - III 223 5 ℓ E1 P001 LPO1 - IBC03 -

See entry above.

1825 SODIUM MONOXIDE  
8 - - II - - 1 kg E2 P002 - IBC08 B2 B4

Deliquescent crystalline solid. Reacts violently with water and acids, generating heat. Reacts with ammonium salts, evolving ammonia gas. In the presence of moisture, corrosive to aluminium, zinc and tin. Causes burns to skin, eyes and mucous membranes.

1826 NITRATING ACID MIXTURE, SPENT with more than 50% nitric acid  
8 5.1 I 113 0 E0 P001 -

Usually a mixture of acids which has been used for nitration processes. Highly corrosive to most metals. Causes severe burns to skin, eyes and mucous membranes. (D) Certified as containing no explosive impurities, chemically stable, and (E) certified as containing no explosive impurities.

1826 NITRATING ACID MIXTURE, SPENT with not more than 50% nitric acid  
8 - - II 113 1 ℓ E2 P001 - IBC02 B20

See entry above.

1827 STANNIC CHLORIDE, ANHYDROUS  
8 - - II - - 1 ℓ E2 P001 - IBC02 -

Colourless liquid. In the presence of water, corrosive to most metals. Vapour irritates mucous membranes.

1828 SULPHUR CHLORIDES  
8 - - I - - 0 E0 P602 - -

Red liquids with a suffocating odour. React violently with water, evolving hydrogen chloride and sulphur dioxide, irritating and corrosive gases. In the presence of moisture, highly corrosive to most metals. Causes severe burns to skin, eyes and mucous membranes.

1829 SULPHUR TRIOXIDE, STABILIZED  
8 - - I - - 0 E0 P001 - -

Very deliquescent solid. Melting point may be as low as 17°C. Reacts violently with water, generating heat. May cause fire in contact with organic materials such as wood, cotton or straw. In the presence of moisture, highly corrosive to most metals. Causes severe burns to skin, eyes and mucous membranes.

1830 SULPHURIC ACID with more than 51% acid  
8 - - II - - 1 ℓ E2 P001 - IBC02 B20

Colourless, oily liquid, mixture over 1.41 up to 1.84 relative density, in the presence of moisture, highly corrosive to most metals. Causes burns to skin, eyes and mucous membranes.

1831 SULPHURIC ACID, FUMING  
8 6.1 I - - 0 E0 P602 - -

Colourless, oily liquid, may be partly crystallized. Solution of varying quantities of sulphur trioxide in sulphuric acid. Reacts violently with water and organic material, generating heat. In the presence of moisture, highly corrosive to most metals. Toxic if swallowed, by skin contact or by inhalation. Causes severe burns to skin, eyes and mucous membranes.

1832 SULPHURIC ACID, SPENT  
8 - - II 113 1 ℓ E2 P001 - IBC02 B20

Sulphuric acid, usually of high concentration, which has been used for chemical processes. Highly corrosive to most metals.

1833 SULPHUROUS ACID  
8 - - II - - 1 ℓ E2 P001 - IBC02 -

Solution of sulphur dioxide in water, with a suffocating odour. Corrosive to most metals. Vapour irritates mucous membranes.

1834 SULPHURYL CHLORIDE  
6.1 8 I 354 0 E0 P602 - -

Colourless liquid with a pungent odour. Boiling point: 69°C. Reacts violently with water, generating heat. In the presence of moisture, highly corrosive gas apparent as white fumes. In the presence of moisture, highly corrosive to most metals. Causes severe burns to skin, eyes and mucous membranes. Highly toxic if swallowed, by skin contact or by inhalation.

1835 TETRAMETHYLAMMONIUM HYDROXIDE SOLUTION  
8 - - II - - 1 ℓ E2 P001 - IBC02 -

Miscible with water. Reacts violently with acids.

1835 TETRAMETHYLAMMONIUM HYDROXIDE SOLUTION  
8 - - III 223 5 ℓ E1 P001 LPO1 - IBC03 -

See entry above.

UN No. (1)	PSN (2)	Class or Div (5)	Subsidiary Risk(s) (4)	Packing Group (3)	Special Provisions (6)	Limited quantities (7a)	Excepted quantities (7b)	Packing		IBC	
								Instruc-tions (8)	Provisions (9)	Instruc-tions (10)	Provisions (11)
3.1.2		2.0	2.0	2.0, 1.3	3.3	3.4	3.5	4.1, 4	4.1, 4		
1836	THIONYL CHLORIDE	8	-	I	-	0	EO	P602	-	-	-
1837	THIOPHOSORYL CHLORIDE	8	-	II	-	1 ℓ	E2	P001	-	IBC02	-
1838	TITANIUM TETRACHLORIDE	6.1	8	I	354	0	EO	P602	-	-	-
1839	TRICHLOROACETIC ACID, SOLID	8	-	II	-	1 kg	E2	P002	-	IBC08	B2 B4
1840	ZINC CHLORIDE SOLUTION	8	-	III	223	5 ℓ	E1	P001 LPO1	-	IBC03	-
1841	ACETALDEHYDE AMMONIA	9	-	III	-	5 kg	E1	P002 LPO2	-	IBC08	B3 B6
1843	AMMONIUM DINITRO- <i>o</i> -CRESOLATE, SOLID	6.1	-	P	-	500 g	E4	P002	-	IBC08	B2 B4
1845	CARBON DIOXIDE, SOLID (DRY ICE)	9	-	-	-	0	EO	P003	PPI 8	-	-
1846	CARBON TETRACHLORIDE	6.1	-	II	-	100 ml <sup>a</sup>	E4	P001	-	IBC02	-
1847	POTASSIUM SULPHIDE, HYDRATED with not less than 30% water of crystallization	8	-	II	-	1 kg	E2	P002	-	IBC08	B2 B4
1848	PROPIONIC ACID with not less than 10% and less than 30% acid, by mass	8	-	III	-	5 ℓ	E1	P001 LPO1	-	IBC03	-
1849	SODIUM SULPHIDE, HYDRATED with not less than 30% water	8	-	II	-	1 kg	E2	P002	-	IBC08	B2 B4
1851	MEDICINE, LIQUID, TOXIC, N.O.S.	6.1	-	II	221	100 ml <sup>a</sup>	E4	P001	-	-	-
1851	MEDICINE, LIQUID, TOXIC, N.O.S.	6.1	-	III	221 223	5 ℓ	E1	P001 LPO1	-	-	-
1854	BARIUM ALLOYS, PYROPHORIC	4.2	-	I	-	0	EO	P404	PP31	-	-

UN No. (16)	Properties and Observations (17)	Stowage and Segregation (16)	Portable tanks and bulk containers	
			Tank instructions (15)	Provisions (14)
1836	Yellow or red liquid. Boiling point: 79°C. Reacts violently with water, evolves flammable gases. In the presence of moisture, highly corrosive to most metals. Causes severe burns to skin, eyes and mucous membranes.		TP2 TP3	F-A, S-B
1837	Colourless liquid with a pungent odour. Reacts violently with water, evolving hydrogen chloride irritating and corrosive vapours as well as white fumes. In the presence of moisture, highly corrosive to most metals. Vapour irritates mucous membranes.		TP2	F-A, S-B
1838	Colourless liquid. Reacts violently with water, evolving hydrogen chloride, an irritating and corrosive gas apparent as white fumes. In the presence of moisture, highly corrosive to most metals. Highly toxic if swallowed, by skin contact or by inhalation. Causes burns to skin, eyes and mucous membranes.	7.1 to 7.7	TP2 TP3 TP7	F-A, S-B
1839	Colourless, deliquescent crystals. Melting point of the pure substance: 53°C. In the presence of moisture, corrosive to most metals. Causes burns to skin, eyes and mucous membranes.		TP3	F-A, S-B
1840	Colourless liquid. Mildly corrosive to most metals. Causes burns to skin, eyes and mucous membranes.		TP1	F-A, S-B
1841	White crystalline solid. Soluble in water. When heated, decomposes into ammonia and acetaldehyde.		TP3	F-A, S-B
1843	May support combustion and burn without oxygen. When involved in a fire, may produce toxic and corrosive fumes. Reacts violently with lead, silver or other heavy metals and their compounds. Toxic if swallowed, by skin contact or by inhalation.		TP3	F-A, S-A
1845	Non-flammable gas in a white solid form. Slowly evolves vapours which are heavier than air (1.5). Inhalation of vapours may lead to unconsciousness. Can cause severe burns when in contact with the skin.		-	F-C, S-V
1846	Colourless, volatile liquid with a heavy anaesthetic vapour. Non-flammable, when involved in a fire, evolves extremely toxic fumes (phosgene). Toxic if swallowed, by skin contact or by inhalation.		TP2	F-A, S-A
1847	Crystalline solid. Melting point: 60°C. Reacts violently with acids, evolving highly toxic and corrosive fumes. Causes burns to skin, eyes and mucous membranes.		TP3	F-A, S-B
1848	Colourless liquid with a pungent odour. Miscible with water. Corrosive to other metals. Burns skin. Vapour irritates mucous membranes.		TP1	F-A, S-B
1849	Yellow, white, or white deliquescent crystals, flakes or lumps. Melting point: 51°C. Soluble in water. Reacts violently with acids, evolving hydrogen sulphide, a toxic and flammable gas. Mildly corrosive to most metals. Causes burns to skin, eyes and mucous membranes.		TP3	F-A, S-B
1851	Toxic if swallowed, by skin contact or by inhalation.		-	F-A, S-A
1851	See entry above.		-	F-A, S-A
1854	Can ignite spontaneously in air. If shaken, may produce sparks. In contact with water, evolve hydrogen, a flammable gas.		TP2 TP3	F-G, S-W

**TSFS 2015:66**  
**Bilaga 1**

UN No. (1)	PSN (2)	Class or Div (3)	Subsidiary Risk(s) (4)	Packing Group (5)	Special Provisions (6)	Limited quantities (7a)	Excepted quantities (7b)	Packing		IBC		EMs (15)	Stowage and Segregation (16)	Properties and Observations (17)	UN No. (18)
								Instructions (8)	Provisions (9)	Instructions (10)	Provisions (11)				
1855	CALCIUM PHOSPHORIC CALCIUM ALLOYS, PYROPHORIC	4.2	-	I	-	0	EO	P404	PP31	-	-	F-C, S-M	Category D.	Liabile to ignite spontaneously in air. If shaken, may produce sparks. In contact with water, evolve hydrogen, a flammable gas.	1855
1856	RACS, OILY	4.2	-	-	29 117	0	EO	P003	PP19	IBC08	B3 B6	F-A, S-J	Category A.	Liabile to ignite spontaneously in air according to oil content.	1856
1857	TEXTILE WASTE, WET	4.2	-	III	117	0	E1	P410	-	-	-	F-A, S-J	Category A	Liabile to ignite spontaneously in air according to moisture content.	1857
1858	HEXAFLUOROPROPYLENE (REFRIGERANT GAS R 1216)	2.2	-	-	-	120 ml	E1	P200	-	-	-	F-C, S-V	Category A.	Non-flammable gas. Much heavier than air (5.2).	1858
1859	SILICON TETRAFLUORIDE	2.3	8	-	-	0	EO	P200	-	-	-	F-C, S-U	Category D. Clear of living quarters.	Non-flammable, toxic and corrosive gas with a pungent odour. Corrosive to metals. In moist air produces hydrogen fluoride. Much heavier than air (3.6). Highly irritating to skin, eyes and mucous membranes.	1859
1860	VINYL FLUORIDE, STABILIZED	2.1	-	-	-	0	EO	P200	-	-	-	F-D, S-U	Category E. Clear of living quarters.	Flammable gas. Explosive limits: 2.9% to 29%. Heavier than air (1.6).	1860
1862	ETHYL CROTONATE	3	-	II	-	1 l	E2	P001	-	IBC02	-	F-E, S-D	Category B.	Colourless liquid with a pungent odour. Flashpoint: 2 C.c.c. Immiscible with water.	1862
1863	FUEL, AVIATION, TURBINE ENGINE	3	-	I	363	500 ml	E3	P001	-	-	-	F-E, S-E	Category E.	Boiling range: -14°C upwards. Immiscible with water.	1863
1863	FUEL, AVIATION, TURBINE ENGINE	3	-	II	363	1 l	E2	P001	-	IBC02	-	F-E, S-E	Category B.	Immiscible with water.	1863
1863	FUEL, AVIATION, TURBINE ENGINE	3	-	III	223, 363	5 l	E1	P001 LP01	-	IBC03	-	F-E, S-E	Category A.	See entry above.	1863
1865	n-PROPYL NITRATE	3	-	II	26	1 l	E2	P001	-	-	-	F-E, S-D	Category D. Segregation as for class 5.1. But "Away from" classes 4.1, 5.1 and 7.	White to straw-coloured liquid with an ether-like odour. Flashpoint: 20°C C.c.c. Explosive limits: 2% to 100%. Immiscible with water. Oxidizing material. May explode on heating. Lethal if swallowed or by inhalation.	1865
1866	RESIN SOLUTION flammable	3	-	I	-	500 ml	E3	P001	-	-	-	F-E, E	Category E.	Miscibility with water depends upon the composition.	1866
1866	RESIN SOLUTION flammable	3	-	II	-	5 l	E2	P001	PP1	IBC02	-	F-E, S-E	Category B.	See entry above.	1866
1866	RESIN SOLUTION flammable	3	-	III	223 955	5 l	E1	P001 LP01	-	IBC03	-	F-E, S-E	Category A.	See entry above.	1866
1868	DECABORANE	4.1	6.1	II	-	1 kg	E2	P002	PP31	IBC06	B2	F-A, S-G	Category A. "Separated from" class 5.1.	Colourless crystals. Slightly soluble in water. Vapours may form explosive mixture in air. Forms explosive and extremely sensitive mixtures with oxidizing substances. Toxic if swallowed, by skin contact or by dust inhalation.	1868
1869	MAGNESIUM or MAGNESIUM ALLOYS with more than 50% magnesium in pellets, turnings or ribbons	4.1	-	III	50 920	5 kg	E1	P002 LP02	-	IBC08	B3	F-C, S-G	Category A. "Away from" liquid "Separated from" class 5.1. acids, alkalis and iron oxide.	Silvery white metal. Burns with an intense white light and heat. In contact with water, evolves hydrogen gas. Reacts readily with acids and caustic alkali, evolving hydrogen. Reacts readily with iron oxide, producing a thermite effect. Forms explosive mixtures with oxidizing substances.	1869



UN No. (1)	PSN (2)	Class No. (3)	Subsidiary Risk(s) (4)	Packing Group (5)	Special Provisions (6)	Limited quantities (7a)	Excepted quantities (7b)	Packing			Portable tanks and bulk containers			Properties and Observations (17)	UN No. (18)		
								Class (8)	Subsidiary Risk(s) (9)	Packing Group (10)	Instructions (11)	Provisions (12)	Instructions (13)			Provisions (14)	EMs (15)
1870	POTASSIUM BOROXYDIDE	4.3	-	I	-	0	E0	P403	PP31	-	-	-	F-C, S-O	Category E. "Separated from" acids.	White, crystalline powder. In contact with water, acids or moisture evolves hydrogen, which may be ignited by the heat of the reaction.	1870	
1871	TITANIUM HYDRIDE	4.1	-	II	-	1 kg	E2	P410	PP31 PM40	IBC04	-	T3	TP33	F-A, S-C	Category E.	Dark grey powder or crystals.	1871
1872	LEAD DIOXIDE	5.1	-	III	-	5 kg	E1	P002 LP02	-	IBC08	B3	T1	TP33	F-A, S-Q	Category A.	Brown powder or crystals. Insoluble in water. Harmful if swallowed.	1872
1873	PERCHLORIC ACID with more than 50% but not more than 72% acid, by mass	5.1	8	I	900	0	E0	P502	PP28	-	-	T10	TP1	F-A, S-Q	Category D. "Separated from" class 4.1.	Colourless liquid. Mixtures with combustible material may ignite spontaneously and, when involved in a fire, by shock or by friction, may explode. Causes severe burns to skin, eyes and mucous membranes. Transport of PERCHLORIC ACID with more than 72% acid, by mass is prohibited.	1873
1884	BARIUM OXIDE	6.1	-	III	-	5 kg	E1	P002 LP02	-	IBC08	B3	T1	TP33	F-A, S-A	Category A.	White solid. Evolves heat. In contact with water. Toxic if swallowed, by skin contact or by dust inhalation.	1884
1885	BENZIDINE	6.1	-	II	-	500 g	E4	P002	-	IBC08	B2 B4	T3	TP33	F-A, S-A	Category A.	White, crystalline solid. Toxic if swallowed, by skin contact or by inhalation.	1885
1886	BENZYLIDENE CHLORIDE	6.1	-	II	-	100 ml	E4	P001	-	IBC02	-	T7	TP2	F-A, S-A	Category D. Clear of living quarters.	Colourless liquid evolving vapour which is irritating to eyes and skin ("Tear Gas"), toxic if swallowed, by skin contact or by inhalation.	1886
1887	BROMOCHLOROMETHANE	6.1	-	III	-	5 l	E1	P001 LP01	-	IBC03	-	T4	TP1	F-A, S-A	Category A.	Clear, colourless, volatile liquid with a chloroform-like odour. Immiscible with water. When involved in a fire, evolves extremely toxic fumes (phosgene). Toxic if swallowed, by skin contact or by inhalation.	1887
1888	CHLOROFORM	6.1	-	III	-	5 l	E1	P001 LP01	-	IBC03	-	T7	TP2	F-A, S-A	Category A. Clear of living quarters.	Colourless, volatile liquid. Boiling point: 61°C. Non-flammable. When involved in a fire, evolves extremely toxic fumes (phosgene). Toxic if swallowed, by skin contact or by inhalation. Anaesthetic.	1888
1889	CYANOGEN BROMIDE	6.1	8	I	-	0	E5	P002	PP31	-	-	T6	TP33	F-A, S-B	Category D. Clear of living quarters. "Separated from" acids.	Colourless crystals evolving toxic vapour which is irritating and causes tears. Melting point: approximately 52°C. Boiling point: approximately 62°C. In contact with water evolves hydrogen bromide and hydrogen cyanide, which are highly toxic, flammable and corrosive gases. Highly volatile. Causes severe burns to skin, eyes and mucous membranes.	1889
1891	ETHYL BROMIDE	6.1	-	II	-	100 ml	E4	P001	-	IBC02	B8	T7	TP2 TP13	F-A, S-A	Category B. In a mechanically ventilated space. Clear of living quarters.	Colourless volatile liquid, evolving irritating vapour with a narcotic effect. Boiling point: 38°C. Vapour can be ignited by an electric spark or similar sources of ignition. Toxic if swallowed, by skin contact or by inhalation.	1891
1892	ETHYLCHLOROARSINE	6.1	-	I	354	0	E0	P602	-	-	-	T20	TP2 TP13 TP37	F-A, S-A	Category D. Clear of living quarters.	Colourless liquid evolving irritating vapour ("Tear Gas"). Highly toxic if swallowed, by skin contact or by inhalation.	1892
1894	PHENYLMERCURIC HYDROXIDE	6.1	-	II	-	500 g	E4	P002	-	IBC08	B2 B4	T3	TP33	F-A, S-A	Category A.	White crystals or powder. Soluble in water. Toxic if swallowed, by skin contact or by dust inhalation.	1894
1895	PHENYLMERCURIC NITRATE	6.1	-	II	-	500 g	E4	P002	-	IBC08	B2 B4	T3	TP33	F-A, S-A	Category A.	White crystals or powder. Toxic if swallowed, by skin contact or by inhalation.	1895
1897	TETRACHLOROETHYLENE	6.1	-	III	-	5 l	E1	P001 LP01	-	IBC03	-	T4	TP1	F-A, S-A	Category A. Clear of living quarters.	Colourless liquid with an ethereal odour. When involved in a fire, evolves extremely toxic fumes (phosgene). Toxic if swallowed, by skin contact or by inhalation.	1897

**TSFS 2015:66**  
**Bilaga 1**

UN No. (1)	PSN (2)	Class No. (3)	Subsidiary Risk(s) (4)	Packing Group (5)	Special Provisions (6)	Limited quantities (7a)	Excepted quantities (7b)	Packing			Portable tanks and bulk containers			Properties and Observations (17)	UN No. (18)		
								Class (8)	IBC (9)	Institutions (10)	Provisions (11)	IBC (12)	Institutions (13)			Provisions (14)	EMs (15)
1898	ACETYL IODIDE	8	-	II	-	1 ℓ	E2	P001	-	IBC02	-	T7	TP2 TP3	F-A, S-B	Category C. Clear of living quarters.	Colourless liquid. Reacts violently with water, evolving hydrogen iodide, and forming a white precipitate of iodine on membranes. Highly corrosive to most metals. Vapour irritates mucous membranes.	1898
1902	DISOCTYL ACID PHOSPHATE	8	-	III	-	5 ℓ	E1	R001 LP01	-	IBC03	-	T4	TP1	F-A, S-B	Category A.	Oily liquid. Mildly corrosive to most metals.	1902
1903	DISINFECTANT, LIQUID, CORROSIVE, N.O.S.	8	-	I	274	0	E0	P001	-	-	-	-	-	F-A, S-B	Category B.	A wide variety of corrosive liquids. Causes burns to skin, eyes and mucous membranes.	1903
1903	DISINFECTANT, LIQUID, CORROSIVE, N.O.S.	8	-	II	274	1 ℓ	E2	P001	-	IBC02	-	-	-	F-A, S-B	Category B.	See entry above.	1903
1903	DISINFECTANT, LIQUID, CORROSIVE, N.O.S.	8	-	III	223 274	5 ℓ	E1	P001 LP01	-	IBC03	-	-	-	F-A, S-B	Category A.	See entry above.	1903
1905	SELENIC ACID	8	-	I	-	0	E0	P002	-	IBC07	B1	T6	TP33	F-A, S-B	Category A.	White, very deliquescent crystalline solid. Melting point: 50°C. Soluble in water. Reacts violently with organic materials such as wood, cotton or straw. In the presence of moisture, corrosive to most metals. Causes severe burns to skin, eyes and mucous membranes.	1905
1906	SLUDGE ACID	8	-	II	-	1 ℓ	E2	P001	-	IBC02	-	T8	TP2 TP8	F-A, S-B	Category C. For metal drums, Category B.	Waste or spent sulphuric acid, usually a by-product of refining petroleum oils or crude benzenes. Highly corrosive to most metals.	1906
1907	SODALIME with more than 4% sodium hydroxide	8	-	III	62	5 kg	E1	P002 LP02	-	IBC08	B3	T1	TP33	F-A, S-B	Category A. "Separated from" at 65.	Deliquescent, granulated, mixture of sodium hydroxide and calcium hydroxide. Reacts violently with acids. Reacts with ammonium salts, evolving ammonia gas. In the presence of moisture, corrosive to aluminium, zinc and tin. Causes burns to skin, eyes and mucous membranes.	1907
1908	CHLORITE SOLUTION	8	-	II	-	1 ℓ	E2	P001	-	IBC02	-	T7	TP2 TP4	F-A, S-B	Category B. "Away from" acids. Segregation as for class 5.1 but "Away from" classes 4.1, 5.1 and 7.	Colourless liquid. In contact with acids, evolves very irritating and corrosive gases. Oxidizing solution. May cause fire in contact with organic materials such as wood, cotton or straw. Mildly corrosive to most metals. Causes burns to skin, eyes and mucous membranes.	1908
1908	CHLORITE SOLUTION	8	-	III	223	5 ℓ	E1	P001 LP01	-	IBC03	-	T4	TP2 TP4	F-A, S-B	Category B. "Away from" acids. Segregation as for class 5.1 but "Away from" classes 4.1, 5.1 and 7.	See entry above.	1908
1910	CALCIUM OXIDE	8	-	-	960	-	-	-	-	-	-	-	-	-	-	Not subject to the provisions of this Code but may be subject to provisions governing the transport of dangerous goods by other modes.	1910
1911	DIBORANE	2.3	2.1	-	-	0	E0	P200	-	-	-	-	-	F-D, S-U	Category D. Clear of living quarters. "Separated from" chlorine.	Liquefied, flammable, toxic, colourless gas with an unpleasant odour. Explosive limits: 0.9% to 98%. Lighter than air (0.95). May decompose above -18 °C with the formation of hydrogen and boron hydrides. Autoignition temperature: 90 °C. Toxic by inhalation; forms boric acid and water by hydrolysis within the lungs.	1911
1912	METHYL CHLORIDE AND METHYLENE CHLORIDE MIXTURE	2.1	-	-	228	0	E0	P200	-	-	-	T50	-	F-D, S-U	Category D. Clear of living quarters.	Solution of the flammable gas methyl chloride, UN No. 1063, in the liquid methylene chloride.	1912
1913	NEON, REFRIGERATED LIQUID	2.2	-	-	-	120 ml	E1	P203	-	-	-	T75	TP5	F-C, S-V	Category D.	Liquefied, inert gas. Lighter than air (0.7).	1913
1914	BUTYLPROPANATES	3	-	III	-	5 ℓ	E1	P001 LP01	-	IBC03	-	T2	TP1	F-E, S-D	Category A.	Colourless liquids. Flashpoint 32°C c.c. Immiscible with water.	1914

UN No. (1)	PSN (2)	Class or Div. (3)	Subsidiary Risk(s) (4)	Packing Group (5)	Special Provisions (6)	Limited quantities (7a)	Excepted quantities (7b)	Packing		IBC		Portable tanks and bulk containers			Properties and Observations (17)	UN No. (18)		
								Institu-tions (8)	Provisions (9)	Institu-tions (10)	Provisions (11)	Tank instructions (12)	Provisions (13)	EMS (15)			Stowage and Segregation (16)	
3	3.1.2	2.0	2.0	2.0, 1.3	3.3	3.4	3.5	4.1, 4	P001 LPO1	-	IBC03	-	T2	TP1	F-E, S-D	Category A.	Colourless liquid. Flashpoint: 38°C to 44°C c.c. Explosive limits: 1.1% to 9.4%. Immiscible with water.	1915
6.1	2,2-DICHLORODIETHYL ETHER	3	3	II	-	100 ml	E4	P001	-	IBC02	-	T7	TP2	F-E, S-D	Category A.	Colourless, flammable liquid. Flashpoint: 55°C c.c. Immiscible with water, but reacts with it, forming a flammable and toxic fumes. Toxic if swallowed, by skin contact or by inhalation.	1916	
3	ETHYL ACRYLATE, STABILIZED	3	-	II	-	1 l	E2	P001	-	IBC02	-	T4	TP1 TP3	F-E, S-D	Category B. Clear of living quarters.	Colourless liquid with a pungent odour. Flashpoint: 16°C c.c. Explosive limits: 1.8% to 14%. Immiscible with water. Irritating to skin, eyes and mucous membranes.	1917	
3	ISOPROPYLBENZENE	3	-	III	-	5 l	E1	P001 LPO1	-	IBC03	-	T2	TP1	F-E, S-E	Category A.	Colourless liquid with a chloroform-like odour. Flashpoint: 31°C c.c. Explosive limits: 0.9% to 6.5%. Immiscible with water.	1918	
3	METHYL ACRYLATE, STABILIZED	3	-	II	-	1 l	E2	P001	-	IBC02	-	T4	TP1 TP3	F-E, S-D	Category B.	Colourless, volatile liquid with a pungent odour. Flashpoint: -3°C c.c. Explosive limits: 1.2% to 25%. Immiscible with water. Harmful by inhalation. Irritating to skin, eyes and mucous membranes.	1919	
3	NONANES	3	-	III	-	5 l	E1	P001 LPO1	-	IBC03	-	T2	TP1	F-E, S-E	Category A.	Colourless liquids. Explosive limits: 0.8% to 2.9%. normal-NONANE: flashpoint 31°C c.c. Immiscible with water. Irritating to skin, eyes and mucous membranes.	1920	
3	PROPYLENIMINE, STABILIZED	3	6.1	I	-	0	E0	P001	-	-	-	T14 TP3	TP2 TP3	F-E, S-D	Category B. Clear of living quarters.	Colourless liquid with an ammoniacal odour. Flashpoint: -4°C c.c. Miscible with water. Irritating to skin, eyes and mucous membranes.	1921	
3	PIRROUDINE	3	8	II	-	1 l	E2	P001	-	IBC02	-	T7	TP1	F-E, S-C	Category B. Clear of living quarters. Separated from acids.	Colourless to pale yellow liquid, with an ammoniacal odour. Reacts spontaneously with water. Flashpoint 10°C c.c. Immiscible with water by inhalation. Causes burns to skin, eyes and mucous membranes.	1922	
4.2	CALCIUM DITHIONITE (CALCIUM HYDROSULPHITE)	4.2	-	II	-	0	E2	P410 P31	IBC06 B2	IBC06 B2	-	T3	TP33	F-A, S-J	Category E. Keep as dry as reasonably practicable.	Liable to heat and ignites spontaneously in air and to evolve sulphur dioxide, an irritating gas.	1923	
4.3	METHYLMAGNESIUM BROMIDE IN ETHYL ETHER	4.3	3	I	-	0	E0	P402	-	-	-	-	-	F-G, S-L	Category D.	Colourless, yellowish liquid. Decomposes violently in contact with water. Spillage will ignite spontaneously.	1928	
4.2	POTASSIUM DITHIONITE (POTASSIUM HYDROSULPHITE)	4.2	-	II	-	0	E2	P410 P31	IBC06 B2	IBC06 B2	-	T3	TP33	F-A, S-J	Category E. Keep as dry as reasonably practicable.	Liable to heat and ignites spontaneously in air and to evolve sulphur dioxide, an irritating gas.	1929	
9	ZINC DITHIONITE (ZINC HYDROSULPHITE)	9	-	III	-	5 kg	E1	P002 UP02	-	IBC08 B3	-	T1	TP33	F-A, S-J	Category A. Keep as dry as reasonably practicable. Away from class 6.2 and acids.	White, amorphous, solid material. Soluble in water. Liable to heat on contact with moisture and heating results in evolution of sulphur dioxide, an intensely irritating gas. Also evolves sulphur dioxide on contact with acids.	1931	
4.2	ZIRCONIUM, SCRAP	4.2	-	III	223	0	E1	P002 UP02	IBC08 B3	IBC08 B3	-	T1	TP33	F-G, S-L	Category D.	Particle size larger than 840 microns. Readily flammable, may ignite spontaneously in air. In contact with water, may evolve hydrogen, a flammable gas.	1932	
6.1	CYANIDE SOLUTION, N.O.S.	6.1	-	I	274	0	E5	P001	-	-	-	T14 TP3 TP27	TP2 TP3	F-A, S-A	Category B. Clear of living quarters. Separated from acids.	Liquid evolving toxic vapour. Reacts with acids or acid fumes, evolving hydrogen cyanide, a highly toxic and flammable gas. Toxic if swallowed, by skin contact or by inhalation.	1935	
6.1	CYANIDE SOLUTION, N.O.S.	6.1	-	II	274	100 ml	E4	P001	-	IBC02	-	T11 TP3 TP27	TP2 TP3	F-A, S-A	Category A. Clear of living quarters. Separated from acids.	See entry above.	1935	

# TSFS 2015:66 Bilaga 1

UN No. (1)	PSN (2)	Class or Div. (5)	Subsidiary Risk(s) (4)	Packing Group (3)	Special Provisions (6)	Limited quantities (7a)	Excepted quantities (7b)	Packing		IBC		Portable tanks and bulk containers		EMS (15)	Stowage and Segregation (16)	Properties and Observations (17)	UN No. (18)
								Institu-tions (8)	Provisions (9)	Institu-tions (10)	Provisions (11)	Tank instructions (14)	Provisions (13)				
1935	CYANIDESOLUTION, N.O.S.	6.1	P	III	223 274	5 ℓ	E1	P001 LP01	-	IBC03	-	T7	TP2 TP2 TP2 TP2 TP2 TP2 TP2 TP2	F-A, S-A Separated from acids.	Category A. Clear of living quarters. See entry above.		1935
1938	BROMOACETIC ACID SOLUTION	8	-	II	-	1 ℓ	E2	P001	-	IBC02	-	T7	TP2	F-A, S-B	Category A. Clear of living quarters. Corrosive to most metals. Harmful if swallowed. Causes burns to eyes and skin.		1938
1938	BROMOACETIC ACID SOLUTION	8	-	III	223	5 ℓ	E1	P001 LP01	-	IBC03	-	T7	TP2	F-A, S-B	Category A. Clear of living quarters. See entry above.		1938
1939	PHOSPHORUS OXYBROMIDE	8	-	II	-	1 kg	E2	P002	-	IBC08	B2 B4	T3	TP33	F-A, S-B	Category C. Keep as cool as practicable. Clear of living quarters.	Colourless crystals. Melting point: 56 °C. Reacts violently with water, forming phosphorous acid. Reacts violently with organic materials (such as wood, cotton, straw), causing fire. Decomposes when heated, evolving toxic and corrosive gases. When involved in a fire, evolves toxic and corrosive gases. In the presence of moisture, highly corrosive to most metals. Causes burns to skin, eyes and mucous membranes.	1939
1940	THIOGLYCOLIC ACID	8	-	II	-	1 ℓ	E2	P001	-	IBC02	-	T7	TP2	F-A, S-B	Category A.	Colourless liquid with a strong, very unpleasant odour. Corrosive to most metals. Harmful if swallowed.	1940
1941	DIBROMODIFLUOROMETHANE	9	-	III	-	5 ℓ	E1	P001 LP01	-	-	-	T11	TP2	F-A, S-A	Category A. Protected from sources of heat.].	Colourless, heavy liquid. Boiling point: 24 °C. Immiscible with water. When involved in a fire, may evolve toxic fumes. Toxic if swallowed, by skin contact or by inhalation. Irritating to skin, eyes and mucous membranes.	1941
1942	AMMONIUM NITRATE with not more than 0.2% total combustible material, including any organic substance, calculated as carbon to the exclusion of any other added substance	5.1	-	III	900 952 967	5 kg	E1	P002 LP02	-	IBC08	B3	T1 BK2 BK3	TP33	F-H, S-Q	Category C. Category A only if the special stowage provisions of 7.4.1.4 and 7.6.2.8.4. are complied with. "Separated from" class 4.1, combustible material (particularly liquids), bromates, chlorates, bromides, hypochlorites, nitrites, peroxides, organic peroxides and powdered metals. When transported in BK3 bulk container, see 7.6.2.12 and 7.7.3.9.	Crystals, granules or pills. Soluble in water. Supporter of combustion. A major fire aboard a ship carrying this substance may involve a risk of explosion in the event of contamination (e.g. by fuel oil) or strong heating. Decomposes when heated, evolving toxic and corrosive gases which support combustion. Transport of AMMONIUM NITRATE liable to self heating sufficient to initiate decomposition is prohibited.	1942
1944	MATCHES, SAFETY (book, card or strike on box)	4.1	-	III	293 294	5 kg	E1	P407	-	-	-	-	-	F-A, S-I	Category A.	Intended to be ignited on a specially prepared surface.	1944
1945	MATCHES, WAX 'VISTA'	4.1	-	III	294	5 kg	E1	P407	-	-	-	-	-	F-A, S-I	Category B.	Ignite by friction; a prepared surface may be required.	1945
1950	ABROSOLS	2	-	-	63 990 272 327 344 959	See SP277	ED	P207 LP02	P87 L2	-	-	-	-	F-D, S-U	Protected from sources of heat. For ABROSOLS with a maximum water content of 10%: Separation as for class 9.04. Separation as for class 9.04. "Separated from" class 1 except division 1.4. For ABROSOLS with a water content of 10%: Category B. Separation as for class 2. For WASTE ABROSOLS: Category C. Clear of living quarters. Segregation as for class 2. For appropriate sub-division of class 2.	Protected from sources of heat. For ABROSOLS with a maximum water content of 10%: Separation as for class 9.04. "Separated from" class 1 except division 1.4. For ABROSOLS with a water content of 10%: Category B. Separation as for class 2. For WASTE ABROSOLS: Category C. Clear of living quarters. Segregation as for class 2. For appropriate sub-division of class 2.	1950
1951	ARGON, REFRIGERATED LIQUID	2.2	-	-	-	120 mℓ	E1	P203	-	-	-	T75	TP5	F-C, S-V	Category D.	Liquefied, inert gas. Heavier than air (1.4).	1951
1952	ETHYLENE OXIDE AND CARBON DIOXIDE MIXTURE with not more than 9% ethylene oxide	2.2	-	-	-	120 mℓ	E1	P200	-	-	-	-	-	F-C, S-V	Category A.	Liquefied, non-flammable gas with an ether-like odour. Explosive limits: 31% to 52%. Heavier than air (1.5).	1952

UN No. (1)	PSN (2)	Class No. (3)	Subsidiary Risk(s) (4)	Packing Group (5)	Special Provisions (6)	Limited quantities (7a)	Excepted quantities (7b)	Packing		IBC		Portable tanks and bulk containers		Properties and Observations (17)	UN No. (18)	
								Institutions (8)	Provisions (9)	Institutions (10)	Provisions (11)	Tank instructions (12)	Provisions (13)			EMs (15)
3.1.2		2.0	2.0	2.0, 1.3	3.3	3.4	3.5	4.1, 4	4.1, 4	4.1, 4	4.1, 4	4.2, 5	4.2, 5	5.4, 5.2	7.1 to 7.7	
1953	COMPRESSED GAS, TOXIC, FLAMMABLE, N.O.S.	2.3	2.1	-	274	0	EO	P200	-	-	-	-	-	F-D, S-U	Category D. Clear of living quarters. -	1953
1954	COMPRESSED GAS, FLAMMABLE, N.O.S.	2.1	-	-	274	0	EO	P200	-	-	-	-	-	F-D, S-U	Category D. Clear of living quarters. -	1954
1955	COMPRESSED GAS, TOXIC, N.O.S.	2.3	-	-	274	0	EO	P200	-	-	-	-	-	F-C, S-U	Category D. Clear of living quarters. -	1955
1956	COMPRESSED GAS, N.O.S.	2.2	-	-	-	120 ml	EI	P200	-	-	-	-	-	F-C, S-V	Category A. -	1956
1957	DEUTERIUM, COMPRESSED	2.1	-	-	-	0	EO	P200	-	-	-	-	-	F-D, S-U	Category E. Clear of living quarters. Flammable, odourless gas. Much lighter than air (0.14).	1957
1958	1,2-DICHLORO-1,1,2,2-TETRAFLUOROETHANE (REFRIGERANT GAS R 114)	2.2	-	-	-	120 ml	EI	P200	-	-	-	T50	-	F-C, S-V	Category A. Liquefied, non-flammable gas with a faint odour. Much heavier than air (5.9). Boiling point: 4°C.	1958
1959	1,1-DIHALOETHYLENE (REFRIGERANT GAS R 1132a)	2.1	-	-	-	0	EO	P200	-	-	-	-	-	F-D, S-U	Category E. Clear of living quarters. Flammable gas. Explosive limits: 2.3% to 2.5%. Much heavier than air (2.2).	1959
1961	ETHANE, REFRIGERATED LIQUID	2.1	-	-	-	0	EO	P203	-	-	-	T75	TP5	F-D, S-U	Category D. Clear of living quarters. Liquefied, flammable gas with a faint odour. Explosive limits: 3% to 16%. Slightly heavier than air (1.05).	1961
1962	ETHYLENE	2.1	-	-	-	0	EO	P200	-	-	-	-	-	F-D, S-U	Category E. Clear of living quarters. Flammable gas. Explosive limits: 3% to 3.4%. Slightly lighter than air (0.98).	1962
1963	HELIUM, REFRIGERATED LIQUID	2.2	-	-	-	120 ml	EI	P203	-	-	-	T75	TP5 TP54	F-C, S-V	Category D. Liquefied, inert gas. Much lighter than air (0.14).	1963
1964	HYDROCARBON GAS MIXTURE, COMPRESSED, N.O.S.	2.1	-	-	274	0	EO	P200	-	-	-	-	-	F-D, S-U	Category E. Clear of living quarters. Flammable hydrocarbon gas mixture obtained from natural gas or by distillation of petroleum. May contain ethane, propane, propylene, butane, butylenes, etc., in varying proportions. Heavier than air.	1964
1965	HYDROCARBON GAS MIXTURE, LIQUEFIED, N.O.S.	2.1	-	-	274	0	EO	P200	-	-	-	T50	-	E-D, S-U	Category E. Clear of living quarters. Liquefied flammable hydrocarbon gas obtained from natural gas or by distillation of mineral oils or coal, etc. May contain propane, cyclopropane, propylene, butane, butylene, etc., in varying proportions. Heavier than air.	1965
1966	HYDROGEN, REFRIGERATED LIQUID	2.1	-	-	-	0	EO	P203	-	-	-	T75	TP5 TP5 TP54	E-D, S-U	Category D. Clear of living quarters. Liquefied, flammable, odourless gas. Explosive limits: 4% to 75%. Much lighter than air (0.07).	1966
1967	INSECTICIDE GAS, TOXIC, N.O.S.	2.3	-	-	274	0	EO	P200	-	-	-	-	-	F-C, S-U	Category D. Clear of living quarters. Toxic mixtures of insecticides with liquefied gases. These mixtures may be flammable.	1967
1968	INSECTICIDE GAS, N.O.S.	2.2	-	-	274	120 ml	EI	P200	-	-	-	-	-	F-C, S-V	Category A. Non-flammable and non-toxic mixtures of insecticides with liquefied gases.	1968
1969	ISOBUTANE	2.1	-	-	-	0	EO	P200	-	-	-	T50	-	F-D, S-U	Category E. Clear of living quarters. Flammable hydrocarbon. Heavier than air.	1969
1970	KRYPTON, REFRIGERATED LIQUID	2.2	-	-	-	120 ml	EI	P203	-	-	-	T75	TP5	F-C, S-V	Category D. Liquefied, inert gas. Much heavier than air (2.9).	1970

**TSFS 2015:66  
Bilaga 1**

UN No. (1)	PSN (2)	Class No. (3)	Subsidiary Risk(s) (4)	Packing Group (5)	Special Provisions (6)	Limited quantities (7a)	Excepted quantities (7b)	Packing		IBC	
								Institutions (8)	Provisions (9)	Institutions (10)	Provisions (11)
3.1.2		2.0	2.0	2.0, 1.3	3.3	3.4	3.5	4.1, 4	4.1, 4	4.1, 4	

UN No. (1)	Provisions (14)	EMs (15)	Stowage and Segregation (16)	Properties and Observations (17)	UN No. (18)
4.3		7.8			

1971	METHANE, COMPRESSED OR NATURAL GAS, COMPRESSED with high methane content	2.1	-	-	0	EO	P200	-	-	-	-	F-D, S-U	Category E. Clear of living quarters. Flammable gas. Explosive limits: 5% to 16%. Lighter than air (methane 0.53).	1971	
1972	METHANE, REFRIGERATED LIQUID OR NATURAL GAS, REFRIGERATED LIQUID with high methane content	2.1	-	-	0	EO	P203	-	-	-	-	T75	TP5	Category D. Clear of living quarters. Liquefied, flammable gas. Explosive limits: 5% to 16%. Lighter than air (methane 0.55).	1972
1973	CHLORODIFLUOROMETHANE AND CHLOROPENTAFLUOROETHANE MIXTURE with a fixed boiling point, with approximately 49% chlorodifluoromethane (REFRIGERANT GAS R 502)	2.2	-	-	120 mf	E1	P200	-	-	-	-	T50	-	Category A. Liquefied, non-flammable gas. Much heavier than air (4.2).	1973
1974	CHLORODIFLUOROBROMOMETHANE (REFRIGERANT GAS R 12B1)	2.2	-	-	120 mf	E1	P200	-	-	-	-	T50	-	Category A. Liquefied, non-flammable gas. Much heavier than air (5.7).	1974
1975	NITRIC OXIDE AND DINITROGEN TETROXIDE MIXTURE (NITRIC OXIDE AND NITROGEN DIOXIDE MIXTURE)	2.3	5.1/8	-	0	EO	P200	-	-	-	-	-	-	Category D. Clear of living quarters. Segregation as for Class 5.1 but "Separated from" Class 7.	1975
1976	OCTAFLUOROCYCLOBUTANE (REFRIGERANT GAS RC 318)	2.2	-	-	120 mf	E1	P200	-	-	-	-	T50	-	Category A. Liquefied, non-flammable gas. Much heavier than air (7.0).	1976
1977	NITROGEN, REFRIGERATED LIQUID	2.2	-	-	345 346	E1	P203	-	-	-	-	T75	TP5	Category D. Liquefied, non-flammable, colorless gas. Lighter than air (0.97). Arrangements for the containment of the liquid nitrogen and fittings in use should be appropriate to the potential danger to the structure of the freight container or ship from the effect of misuse or accidental spillage.	1977
1978	PROPANE	2.1	2.0	-	0	EO	P200	-	-	-	-	T50	-	Category E. Clear of living quarters. Flammable hydrocarbon gas. Explosive limits: 2.3% to 9.5%. Heavier than air (1.56).	1978
1982	TETRAFLUOROMETHANE (REFRIGERANT GAS R 14)	2.2	-	-	120 mf	E1	P200	-	-	-	-	-	-	Category A. Non-flammable gas. Much heavier than air (3.1).	1982
1983	1-CHLORO-2,2-TRIFLUOROETHANE (REFRIGERANT GAS R 133a)	2.2	-	-	120 mf	E1	P200	-	-	-	-	T50	-	Category A. Liquefied, non-flammable gas. Much heavier than air (4.1). Boiling point: 7°C.	1983
1984	TRIFLUOROMETHANE (REFRIGERANT GAS R 23)	2.2	-	-	120 mf	E1	P200	-	-	-	-	-	-	Category A. Liquefied, non-flammable gas. Much heavier than air (2.4).	1984
1986	ALCOHOLS, FLAMMABLE, TOXIC, N.O.S.	3	6.1	I	274	0	EO	P001	-	-	-	T14	TP2 TP13 TP27	Category E. Clear of living quarters. Toxic if swallowed, by skin contact or by inhalation.	1986
1986	ALCOHOLS, FLAMMABLE, TOXIC, N.O.S.	3	6.1	II	274	1 ℓ	E2	P001	-	IBC02	-	T11	TP2 TP27	Category B. Clear of living quarters. See entry above.	1986
1986	ALCOHOLS, FLAMMABLE, TOXIC, N.O.S.	3	6.1	III	223 274	5 ℓ	E1	P001	-	IBC03	-	T7	TP1 TP28	Category A. See entry above.	1986
1987	ALCOHOLS, N.O.S.	3	-	II	274	1 ℓ	E2	P001	-	IBC02	-	T7	TP1 TP8 TP28	Category B. -	1987
1987	ALCOHOLS, N.O.S.	3	-	III	223 274	5 ℓ	E1	P001 LP01	-	IBC03	-	T4	TP1 TP29	Category A. -	1987

UN No. (1)	PSN (2)	Class or Div. (3)	Subsidiary Risk(s) (4)	Packing Group (5)	Special Provisions (6)	Limited quantities (7a)	Excepted quantities (7b)	Packing			IBC			UN No. (18)	Properties and Observations (17)	
								Class or Div. (5)	Institu-tions (8)	Provisions (9)	Institu-tions (10)	Provisions (11)	Provisions (12)			Institu-tions (13)
	3.1.2	2.0	2.0	2.0.1.3	3.3	3.4	3.5	4.1.4	4.1.4	4.1.4	4.1.4	4.1.4				
1988	ALDEHYDES, FLAMMABLE, TOXIC, N.O.S.	3	6.1	I	274	0	E0	P001	-	-	-	-	TP2 TP27	F-E, S-D	Category E. Clear of living quarters. Toxic if swallowed, by skin contact or by inhalation.	1988
1988	ALDEHYDES, FLAMMABLE, TOXIC, N.O.S.	3	6.1	II	274	1 ℓ	E2	P001	-	IBC02	-	-	TP1 TP27	F-E, S-D	Category B. Clear of living quarters. See entry above.	1988
1988	ALDEHYDES, FLAMMABLE, TOXIC, N.O.S.	3	6.1	III	223 274	5 ℓ	E1	P001	-	IBC03	-	-	T7 TP28	F-E, S-D	Category A. See entry above.	1988
1989	ALDEHYDES, N.O.S.	3	-	I	274	0	E3	P001	-	-	-	-	TP1 TP27	F-E, S-D	Category E.	1989
1989	ALDEHYDES, N.O.S.	3	-	II	274	1 ℓ	E2	P001	-	IBC02	-	-	T7 TP8 TP28	F-E, S-D	Category B.	1989
1989	ALDEHYDES, N.O.S.	3	-	III	223 274	5 ℓ	E1	P001 LP01	-	IBC03	-	-	T4 TP1 TP29	F-E, S-D	Category A.	1989
1990	BENZALDEHYDE	9	-	III	-	5 ℓ	E1	P001 LP01	-	IBC03	-	-	T2 TP1	F-A, S-A	Category A. Colourless or yellowish volatile oil with a bitter almond odour. Slightly soluble in water. Irritating to skin, eyes and mucous membranes.	1990
1991	CHLOROPRENE, STABILIZED	3	6.1	I	-	0	E0	P001	-	-	-	-	TP2 TP27 TP13	F-E, S-D	Category D. Clear of living quarters. Colourless liquid. Flashpoint: -20°C c.c. Explosive limits: 2.5% to 12%. Soluble in water. Toxic if swallowed, by skin contact or by inhalation.	1991
1992	FLAMMABLE LIQUID, TOXIC, N.O.S.	3	6.1	I	274	0	E0	P001	-	-	-	-	TP2 TP13	F-E, S-D	Category E. Clear of living quarters. Flammable toxic liquid which is not specified by name in this class or, on account of its characteristics, in some other class. Toxic if swallowed, by skin contact or by inhalation.	1992
1992	FLAMMABLE LIQUID, TOXIC, N.O.S.	3	6.1	II	274	1 ℓ	E2	P001	-	IBC02	-	-	TP2 TP13	F-E, S-D	Category B. Clear of living quarters. See entry above.	1992
1992	FLAMMABLE LIQUID, TOXIC, N.O.S.	3	6.1	III	223 274	5 ℓ	E1	P001	-	IBC03	-	-	T7 TP1 TP28	F-E, S-D	Category A. See entry above.	1992
1993	FLAMMABLE LIQUID, N.O.S.	3	-	I	274	0	E3	P001	-	-	-	-	TP1 TP27	F-E, S-E	Category E.	1993
1993	FLAMMABLE LIQUID, N.O.S.	3	-	II	274	1 ℓ	E2	P001	-	IBC02	-	-	T7 TP1 TP28	F-E, S-E	Category B.	1993
1993	FLAMMABLE LIQUID, N.O.S.	3	-	III	223 274 955	5 ℓ	E1	P001 LP01	-	IBC03	-	-	T4 TP1 TP29	F-E, S-E	Category A.	1993

**TSFS 2015:66**  
**Bilaga 1**

UN No. (1)	PSN (2)	Class No. (3)	Subsidiary Risk(s) (4)	Packing Group (5)	Special Provisions (6)	Limited quantities (7a)	Excepted quantities (7b)	Packing		IBC		Portable tanks and bulk containers	EMs (15)	Stowage and Segregation (16)	Properties and Observations (17)	UN No. (18)
								Instruc-tions (8)	Provisions (9)	Instruc-tions (10)	Provisions (11)					
1994	IRON PENTACARBONYL	6.1	3	I	354	0	EO	P601	-	-	-	T22 TP13	F-E, S-D	Category D. Clear of living quarters.	Yellow to dark red, volatile flammable liquid. Flashpoint: -15°C. Corrosive to metals. Evolves toxic phosphine gas. Evolves carbon monoxide, which is a toxic gas. Highly toxic if swallowed, by skin contact or by inhalation.	1994
1999	TARS, LIQUID, including road oils, and cutback bitumens.	3	-	II	-	5 ℓ	E2	P001	-	IBC02	-	T3 TP29	F-E, S-E	Category B.	Mobile liquids prepared by mixing asphalt with petroleum distillate. Pungent odour. Immiscible with water.	1999
1999	TARS, LIQUID, including road oils, and cutback bitumens.	3	-	III	955	5 ℓ	E1	P001 LP01	-	IBC03	-	T1 TP3	F-E, S-E	Category A.	See entry above.	1999
2000	CELLULOID in block, rods, rolls, sheets, tubes, etc., except scrap	4.1	-	III	223	5 kg	E1	P002 LP02	PP7	-	-	-	F-A, S-I	Category A.	Igites readily. When involved in a fire, evolves toxic fumes; in enclosed cargo spaces, these fumes may form an explosive mixture with air.	2000
2001	COBALT NAPHTHENATES, POWDER	4.1	-	III	-	5 kg	E1	P002 LP02	-	IBC08	B3	T1 TP33	F-A, S-I	Category A.	Brown, amorphous powder. Insoluble in water. Readily combustible.	2001
2002	CELLULOID, SCRAP	4.2	-	III	223	0	E1	P002 LP02	PP8	IBC08	B3	-	F-A, S-I	Category D.	Igites readily. When involved in a fire, evolves toxic fumes; in enclosed cargo spaces, these fumes may form an explosive mixture with air.	2002
2004	MAGNESIUM DIAMIDE	4.2	-	II	-	0	E2	P410	PP31	IBC06	-	T3	F-G, S-M	Category C.	White powder. Igites spontaneously in air. Reacts violently in contact with water.	2004
2006	PLASTICS, NITROCELLULOSE-BASED, SELF-HEATING, N.O.S.	4.2	-	III	274	0	E1	P002	-	-	-	-	F-A, S-G	Category C.	-	2006
2008	ZIRCONIUM POWDER, DRY	4.2	-	I	-	0	EO	P404	PP31	-	-	T21 TP3	F-G, S-M	Category D.	Amorphous powder. Liable to ignite spontaneously in air. Forms explosive mixtures with oxidizing substances.	2008
2008	ZIRCONIUM POWDER, DRY	4.2	-	II	-	0	E2	P410	PP31	IBC06	B2	T3	F-G, S-M	Category D.	See entry above.	2008
2008	ZIRCONIUM POWDER, DRY	4.2	-	III	223	0	E1	P002 LP02	PP31	IBC08	B3	T1 TP3	F-G, S-M	Category D.	See entry above.	2008
2009	ZIRCONIUM, DRY finished sheets, strip or coiled wire	4.2	-	III	223	0	E1	P002 LP02	PP31	-	-	-	F-G, S-M	Category D.	Hard, silvery metal. Liable to ignite spontaneously in air.	2009
2010	MAGNESIUM HYDRIDE	4.3	-	I	-	0	EO	P403	PP31	-	-	-	F-G, S-O	Category E. *Separated from acids.	White crystals. In contact with water, acids or moisture, evolves hydrogen, which may be ignited by the heat of the reaction.	2010
2011	MAGNESIUM PHOSPHIDE	4.3	6.1	I	-	0	EO	P403	PP31	-	-	-	F-G, S-N	Category E. Under deck in a mechanically ventilated space. Clear of living quarters. *Separated from acids.	Solid. Reacts with acids or decomposes slowly in contact with water or damp air, evolving phosphine, a spontaneously flammable and highly toxic gas. Reacts violently with oxidizing substances. Toxic if swallowed, by skin contact or by inhalation.	2011
2012	POTASSIUM PHOSPHIDE	4.3	6.1	I	-	0	EO	P403	PP31	-	-	-	F-G, S-N	Category E. Under deck in a mechanically ventilated space. Clear of living quarters. *Separated from acids.	Solid. Reacts with acids or decomposes slowly in contact with water or damp air, evolving phosphine, a spontaneously flammable and highly toxic gas. Reacts violently with oxidizing substances. Toxic if swallowed, by skin contact or by inhalation.	2012
2013	STRONTIUM PHOSPHIDE	4.3	6.1	I	-	0	EO	P403	PP31	-	-	-	F-G, S-N	Category E. Under deck in a mechanically ventilated space. Clear of living quarters. *Separated from acids.	Solid. Reacts with acids or decomposes slowly in contact with water or damp air, evolving phosphine, a spontaneously flammable and highly toxic gas. Reacts violently with oxidizing substances. Toxic if swallowed, by skin contact or by inhalation.	2013



UN No. (1)	PSN (2)	Class or Div (5)	Subsidiary Risk(s) (4)	Packing Group (3)	Special Provisions (6)	Limited quantities (7a)	Excepted quantities (7b)	Packing			IBC			UN No. (18)
								Class (8)	PI (9)	IP (10)	IBC02 (11)	IBC03 (12)	IBC04 (13)	
	3.1.2	2.0	2.0	2.0	2.0	3.3	3.4	3.5	4.1.4	4.1.4	4.1.4	4.1.4		
2014	HYDROGEN PEROXIDE, AQUEOUS SOLUTION with not less than 60% hydrogen peroxide (stabilized as necessary)	5.1	8	II	-	1 l	E2	P504	PP10	IBC02	B5		2014	
2015	HYDROGEN PEROXIDE, STABILIZED or HYDROGEN PEROXIDE, AQUEOUS SOLUTION, STABILIZED with more than 60% hydrogen peroxide	5.1	8	I	-	0	E0	P501	-	-	-		2015	
2016	AMMUNITION, TOXIC, NON-EXPLOSIVE without burster or expelling charge, non-fuzed	6.1	-	II	-	0	E0	P600	-	-	-		2016	
2017	AMMUNITION, TEAR-PRODUCING, NON-EXPLOSIVE without burster or expelling charge, non-fuzed	6.1	8	II	-	0	E0	P600	-	-	-		2017	
2018	CHLOROANILINES, SOLID	6.1	-	II	-	500 g	E4	P002	-	IBC08	B2 B4		2018	
2019	CHLOROANILINES, LIQUID	6.1	-	II	-	100 ml	E4	P001	-	IBC02	-		2019	
2020	CHLOROPHENOLS, SOLID	6.1	-	III	205	5 kg	E1	P002 LP02	-	IBC08	B3		2020	
2021	CHLOROPHENOLS, LIQUID	6.1	-	III	-	5 l	E1	P001 LP01	-	IBC03	-		2021	
2022	CRESYLIC ACID	6.1	8	II	-	100 ml	E4	P001	-	IBC02	-		2022	
2023	EPICHLOROHYDRIN	6.1	3 P	II	279	100 ml	E4	P001	-	IBC02	-		2023	
2024	MERCURY COMPOUND, LIQUID, N.O.S.	6.1	-	I	43 66 274	0	E5	P001	-	-	-		2024	
2024	MERCURY COMPOUND, LIQUID, N.O.S.	6.1	-	II	43 66 274	100 ml	E4	P001	-	IBC02	-		2024	
2024	MERCURY COMPOUND, LIQUID, N.O.S.	6.1	-	III	43 66 274	5 l	E1	P001 LP01	-	IBC03	-		2024	
2025	MERCURY COMPOUND, SOLID, N.O.S.	6.1	-	I	43 66 274	0	E5	P002	-	IBC07	B1		2025	
2025	MERCURY COMPOUND, SOLID, N.O.S.	6.1	-	II	43 66 274	500 g	E4	P002	-	IBC08	B2 B4		2025	

**TSFS 2015:66**  
**Bilaga 1**

MSC 90/28/Add.3  
ANNEX 4  
Page 89

MSC 90/28/Add.3  
ANNEX 4  
Page 89

UN No. (1)	PSN (2)	Class or Div (5)	Subsidiary Risk(s) (4)	Packing Group (3)	Special Provisions (6)	Limited quantities (7a)	Excepted quantities (7b)	Packing		IBC		Portable tanks and bulk containers		EMSS (15)	Stowage and Segregation (16)	Properties and Observations (17)	UN No. (18)
								Instruc-tions (8)	Provisions (9)	Instruc-tions (10)	Provisions (11)	Tank instructions (12)	Provisions (13)				
2025	MERCURY COMPOUND, SOLID, N.O.S.	6.1	P	III	43 63 223 274	5 kg	E1	P002 LP02	-	IBC08	B3	T1	TP33	F-A, S-A	Category A.	See entry above.	2025
2026	PHENYLMERCURIC COMPOUND, N.O.S.	6.1	P	I	43 274	0	E5	P002	-	IBC07	B1	T6	TP33	F-A, S-A	Category A.	Usually white crystals or powder. Toxic if swallowed, by skin contact or by dust inhalation.	2026
2026	PHENYLMERCURIC COMPOUND, N.O.S.	6.1	P	II	43 274	500 g	E4	P002	-	IBC08	B2 B4	T3	TP33	F-A, S-A	Category A.	See entry above.	2026
2026	PHENYLMERCURIC COMPOUND, N.O.S.	6.1	P	III	43 223 274	5 kg	E1	P002 LP02	-	IBC08	B3	T1	TP33	F-A, S-A	Category A.	See entry above.	2026
2027	SODIUM ARSENITE, SOLID	6.1	-	II	43	500 g	E4	P002	-	IBC08	B2 B4	T3	TP33	F-A, S-A	Category A.	Greyish-white powder. Soluble in water. Reacts with oxidizing substances, evolving heat. Toxic if swallowed, by skin contact or by dust inhalation.	2027
2028	BOMBS, SMOKE, NON-EXPLOSIVE with corrosive liquid, without initiating device	8	-	II	-	0	E0	P803	-	-	-	-	-	F-A, S-B	Category E. Clear of living quarters.	Corrosive content evolves dense smoke when in contact with air. Corrosive content may cause acid burns to skin.	2028
2029	HYDRAZINE, ANHYDROUS	8	3/6.1	I	-	0	E0	P001	-	-	-	-	-	F-E, S-C	Category D. Clear of living quarters. Segregation as for class 3, but "Away from" class 4.1. "Separated from" acids.	Colourless, flammable liquid with an ammoniacal odour. Reacts violently with acids. Flashpoint: 52 °C c.c. Miscible with water. Highly reactive reducing agent. Ignites spontaneously when in contact with porous materials such as earth, wood or cloth. Toxic if swallowed, by skin contact or by dust inhalation. Causes severe burns to skin, eyes and mucous membranes.	2029
2030	HYDRAZINE, AQUEOUS SOLUTION with more than 37% hydrazine, by mass	8	6.1	I	-	0	E0	P001	-	-	-	T10	TP2 TP13	F-A, S-B	Category D. Clear of living quarters. "Separated from" acids.	Colourless liquid. Powerful reducing agent; burns readily. Toxic if swallowed, by skin contact or by inhalation. Causes burns to skin, eyes and mucous membranes. Reacts violently with acids.	2030
2030	HYDRAZINE, AQUEOUS SOLUTION with more than 37% hydrazine, by mass	8	6.1	II	-	1 ℓ	E2	P001	-	IBC02	-	T7	TP2 TP13	F-A, S-B	Category D. Clear of living quarters. "Separated from" acids.	See entry above.	2030
2030	HYDRAZINE, AQUEOUS SOLUTION with more than 37% hydrazine, by mass	8	6.1	III	-	5 ℓ	E1	P001 LP01	-	IBC03	-	T4	TP1	F-A, S-B	Category D. Clear of living quarters. "Separated from" acids.	See entry above.	2030
2031	NITRIC ACID other than red fuming, with more than 70% nitric acid	8	5.1	I	-	0	E0	P001	PR81	-	-	T10	TP2 TP13	F-A, S-Q	Category D. Segregation as for class 5.1, but "Separated from" classes 4.1, 5.1 and 7.	Colourless liquid. Powerful oxidant; may cause fire in contact with organic materials such as wood, cotton or straw, evolving highly toxic gases (brown fumes). Highly corrosive to most metals. Causes severe burns to skin, eyes and mucous membranes.	2031
2031	NITRIC ACID other than red fuming, with at least 65% but with not more than 70% nitric acid.	8	5.1	II	-	1 ℓ	E2	P001	PR81	IBC02	B15 B20	T8	TP2	F-A, S-Q	Category D. Segregation as for class 5.1, but "Separated from" classes 4.1, 5.1 and 7.	Colourless liquid. Oxidant; may cause fire in contact with organic materials such as wood, cotton or straw, evolving highly toxic gases (brown fumes). Highly corrosive to most metals. Causes severe burns to skin, eyes and mucous membranes.	2031
2031	NITRIC ACID other than red fuming, with less than 65% nitric acid	8	-	II	-	1 ℓ	E2	P001	PR81	IBC02	B15 B20	T8	TP2	F-A, S-B	Category D.	Colourless liquid. Oxidant; may cause fire in contact with organic materials such as wood, cotton or straw, evolving highly toxic gases (brown fumes). Highly corrosive to most metals. Causes severe burns to skin, eyes and mucous membranes.	2031
2032	NITRIC ACID, RED FUMING	8	5.1/6.1	I	-	0	E0	P602	-	-	-	T20	TP2 TP13	F-A, S-Q	Category D. Clear of living quarters. Segregation as for class 5.1, but "Separated from" classes 4.1, 5.1 and 7.	Brown liquid. Powerful oxidant; may cause fire in contact with organic materials such as wood, cotton or straw. Highly corrosive to most metals. Toxic if swallowed, by skin contact or by vapour inhalation. Causes severe burns to skin, eyes and mucous membranes.	2032
2033	POTASSIUM MONOXIDE	8	-	II	-	1 kg	E2	P002	-	IBC08	B2 B4	T3	TP33	F-A, S-B	Category A. "Away from" ammonium salts. "Separated from" acids.	Deliquescent crystalline solid. Reacts violently with water, generating heat. Reacts with ammonium salts, evolving ammonia gas. Reacts violently with acids. In the presence of moisture, corrosive to aluminium, zinc and tin. Causes burns to skin, eyes and mucous membranes.	2033

UN No. (1)	PSN (2)	Class or Div (3)	Subsidiary Risk(s) (4)	Packing Group (5)	Special Provisions (6)	Limited quantities (7a)	Excepted quantities (7b)	Packing			IBC			EMs (15)	Stowage and Segregation (16)	Properties and Observations (17)	UN No. (18)
								Instruc-tions (8)	Provisions (9)	Instruc-tions (10)	Provisions (11)	Instruc-tions (12)	Provisions (13)				
	3.1.2	2.0	2.0	2.0, 1.3	3.3	3.4	3.5	4.1, 4	4.1, 4	4.1, 4	4.1, 4	4.1, 4	4.2, 5 4.3	7.1 to 7.7			
2034 HYDROGEN AND METHANE MIXTURE, COMPRESSED																	
2034		2.1	-	-	-	0	EO	P200	-	-	-	-	-	F-D, S-U	Category E. Clear of living quarters. Flammable, odourless gas mixtures. Much lighter than air. Separated from chlorine.		2034
2035 1,1,1-TRIFLUOROETHANE (REFRIGERANT GAS R 143a)																	
2035		2.1	-	-	-	0	EO	P200	-	-	-	-	T50	F-D, S-U	Category B. Clear of living quarters. Flammable gas with a slight odour. Much heavier than air (2.9).		2035
2036 XENON																	
2036		2.2	-	-	-	120 ml	E1	P200	-	-	-	-	-	F-C, S-V	Category A. Liquefied, inert gas. Much heavier than air (4.5).		2036
2037 RECEPTACLES, SMALL, CONTAINING GAS (GAS CARTRIDGES) WITHOUT A RELEASE DEVICE, NON RELEASABLE																	
2037		2	-	-	191 277 303 344	See SP277	EO	P003	PPI 7	-	-	-	-	F-D, S-U	Category B. Clear of living quarters. Normally contain mixtures of liquefied Butane and Propane in various proportions for use in camping stoves, etc.		2037
2038 DINITROTOLUENES, LIQUID																	
2038		6.1	-	II	-	100 ml	E4	P001	-	IBC02	B20	-	T7	F-A, S-A	Category A. Immiscible with water. A commercial grade consisting of a mixture of the isomers is an oily liquid. Toxic if swallowed, by skin contact or by inhalation.		2038
2044 2,2-DIMETHYLPROPANE																	
2044		2.1	-	-	-	0	EO	P200	-	-	-	-	-	F-D, S-U	Category E. Clear of living quarters. Flammable hydrocarbon gas. Explosive limits: 1.4% to 7.2%. Heavier than air (2.48).		2044
2045 ISOBUTYL ALDEHYDE ISOBUTYRALDEHYDE																	
2045		3	-	II	-	1 l	E2	P001	-	IBC02	-	-	T4	F-E, S-D	Category E. Clear of living quarters. Colourless liquid with a characteristic pungent odour. Flashpoint: -24 C.c. Explosive limits: 1% to 12%. Immiscible with water.		2045
2046 CYMENES																	
2046		3	-	III	-	5 l	E1	P001 LP01	-	IBC03	-	-	T2	F-E, S-D	Category A. Colourless liquids with an aromatic odour. Immiscible with water. Explosive limits: 0.7% to 5.6%.		2046
2047 DICHLOROPROPENES																	
2047		3	-	II	-	1 l	E2	P001	-	IBC02	-	-	T4	F-E, S-D	Category B. Colourless or yellow liquids with a sweet odour. Explosive limits: 5% to 14%. Immiscible with water. Irritating to skin, eyes and mucous membranes.		2047
2047 DICHLOROPROPENES																	
2047		3	-	III	223	5 l	E1	P001 LP01	-	IBC03	-	-	T2	F-E, S-D	Category A. See entry above.		2047
2048 DICYCLOPENTADINE																	
2048		3	-	III	-	5 l	E1	P001 LP01	-	IBC03	-	-	T2	F-E, S-D	Category A. The pure substance is a solid with a melting point of 34°C. Flashpoint: 26°C to 38°C o.c. Commercial products, are liquids. Immiscible with water. Harmful if swallowed.		2048
2049 DIETHYLBENZENE																	
2049		3	-	III	-	5 l	E1	P001 LP01	-	IBC03	-	-	T2	F-E, S-D	Category A. Colourless liquids. Flashpoint: 49°C to 56°C c.c. Immiscible with water. The commercial product is a mixture of isomers.		2049
2050 DISOBUTYLENES, ISOMERIC COMPOUNDS																	
2050		3	-	II	-	1 l	E2	P001	-	IBC02	-	-	T4	F-E, S-D	Category B. Colourless liquids. Flashpoint: -18°C to 21°C c.c. Explosive limits: 0.8% to 4.8%. Immiscible with water.		2050
2051 2-DIMETHYLAMINOETHANOL																	
2051		8	3	II	-	1 l	E2	P001	-	IBC02	-	-	T7	F-E, S-C	Category A. Colourless, flammable liquid with a fishy odour. Flammable, miscible with water. Causes burns to skin, eyes and mucous membranes.		2051
2052 DIPENTENE																	
2052		3	-	III	-	5 l	E1	P001 LP01	-	IBC03	-	-	T2	F-E, S-E	Category A. Colourless liquid with a lemon-like odour. Flashpoint: 43°C c.c. Explosive limits: 0.7% to 6.1%. Immiscible with water.		2052
2053 METHYL ISOBUTYL CARBINOL																	
2053		3	-	III	-	5 l	E1	P001 LP01	-	IBC03	-	-	T2	F-E, S-D	Category A. Colourless liquid. Flashpoint: 41°C c.c. Explosive limits: 1% to 5.5%. Miscible with water. Harmful by inhalation.		2053

**TSFS 2015:66**  
**Bilaga 1**

UN No. (1)	PSN (2)	Class No. (3)	Subsidiary Risk(s) (4)	Packing Group (5)	Special Provisions (6)	Limited quantities (7a)	Excepted quantities (7b)	Packing		IBC	
								Instruc-tions (8)	Provisions (9)	Instruc-tions (10)	Provisions (11)
3.1.2		2.0	2.0	2.0	1.3	3.3	3.4	3.5	4.1, 4	4.1, 4	4.1, 4

UN No. (16)	Properties and Observations (17)	Portable tanks and bulk containers		Stowage and Segregation (16)	Ems (15)	F-E, S-C	TP2	T10
		Provisions (14)	Instruc-tions (15)					
		4.2,5	4.2,5	54,5,2	7,8	F-E, S-C	TP2	Category A.
		7.1 to 7.7						

2054 MORPHOLINE  
Colourless liquid with a fishy odour. Flashpoint: 38°C o.c. by skin contact or by inhalation. Corrosive to skin, eyes and mucous membranes.

2055 STYRENE MONOMER, STABILIZED  
Colourless, oily liquid. Flashpoint: 32°C C.c. Explosive limits: 1.1% to 6.1%.

2056 TETRAHYDROFURAN  
Colourless liquid with an ethereal odour. Flashpoint: below -19°C C.c. Explosive limits: 1.5% to 14%. Miscible with water.

2057 TRIPROPYLENE  
Colourless liquid. Immiscible with water.

2057 TRIPROPYLENE  
See entry above.

2058 VALERALDEHYDE  
Colourless liquid. Flashpoint: 12°C C.c. Partially miscible with water. Irritating to skin, eyes and mucous membranes.

2059 NITROCELLULOSE SOLUTION, FLAMMABLE with not more than 12.6% nitrogen, by dry mass, and not more than 55% nitrocellulose  
When involved in a fire, evolves toxic nitrous fumes.

2059 NITROCELLULOSE SOLUTION, FLAMMABLE with not more than 12.6% nitrogen, by dry mass, and not more than 55% nitrocellulose  
See entry above.

2059 NITROCELLULOSE SOLUTION, FLAMMABLE with not more than 12.6% nitrogen, by dry mass, and not more than 55% nitrocellulose  
See entry above.

2067 AMMONIUM NITRATE BASED FERTILIZER  
Crystals, granules or prills. Wholly or partly soluble in water. Supporters of combustion. A major fire aboard a ship carrying these substances may involve a risk of explosion in the event of contamination (e.g. by fuel oil) or strong confinement. An adjacent detonation may also involve a risk of explosion. The decomposition of these substances may produce toxic gases which support combustion. Toxic to aquatic life. AMMONIUM NITRATE liable to self heating sufficient to initiate decomposition is prohibited.

2071 AMMONIUM NITRATE BASED FERTILIZER  
Usually granules. Wholly or partly soluble in water. These mixtures may be subject to self-sustaining decomposition if heated. The temperature in such a reaction can reach 500°C. Decomposition, once initiated, may spread throughout the remainder, producing gases which are toxic. None of the above applies to ammonium nitrate based fertilizers in which the part of AMMONIUM NITRATE liable to self heating sufficient to initiate decomposition is prohibited.

2073 AMMONIA SOLUTION relative density less than 0.880 at 15°C in water, with more than 35% but not more than 50% ammonia  
Solution in water of non-flammable gas with a pungent odour. Reacts violently with acids. Extremely dangerous to the eyes.

2074 ACRYLAMIDE, SOLID  
Crystals or powder. Soluble in water. May polymerise violently on melting. Toxic if swallowed, by skin contact or by inhalation.

2075 CHLORAL ANHYDRIDE, STABILIZED  
Colourless, mobile liquid, evolving toxic vapours which are considerably heavier than air. Toxic if swallowed, by skin contact or by inhalation.

UN No. (1)	PSN (2)	Class or Div. (3)	Subsidiary Risk(s) (4)	Packing Group (5)	Special Provisions (6)	Limited quantities (7a)	Excepted quantities (7b)	Packing		IBC		Portable tanks and bulk containers		EMS (15)	Stowage and Segregation (16)	Properties and Observations (17)	UN No. (18)
								Instruc-tions (8)	Provisions (9)	Instruc-tions (10)	Provisions (11)	Tank instructions (12)	Provisions (13)				
2076	CRESOLS, LIQUID	6.1	8	II	-	100 ml	E4	P001	-	IBC02	-	T7	TP2	F-A, S-B	Category B.	Colourless to light yellow liquids. Miscible with water. Melting point of 10°C. Corrosive to skin, eyes and mucous membranes. Cause burns to skin, eyes and mucous membranes.	2076
2077	alpha-NAPHTHYLAMINE	6.1	-	III	-	5 kg	E1	P002 LP02	-	IBC08	B3	T1	TP33	F-A, S-A	Category A.	White crystals. Toxic if swallowed, by skin contact or by inhalation.	2077
2078	TOLUENE DIISOCYANATE	6.1	-	II	279	100 ml	E4	P001	-	IBC02	-	T7	TP2 TP13	F-A, S-A	Category C. Clear of living quarters. (Protected from sources of heat.)	Colourless to pale yellow liquid with a pungent odour. Immiscible with water but reacts with it to form carbon dioxide. Melting point: 20°C (pure product). Toxic if swallowed, by skin contact or by inhalation. Irritating to skin, eyes and mucous membranes.	2078
2079	DIETHYLENTRIAMINE	8	-	II	-	1 l	E2	P001	-	IBC02	-	T7	TP2	F-A, S-B	Category A. Clear of living quarters. "Separated from" acids.	Yellow hygroscopic liquid with ammoniacal odour. Soluble in water. Strongly alkaline, corrosive. Can form explosive mixtures with nitric acid. Reacts violently with acids. Corrosive to skin, eyes and mucous membranes. Reacts violently with acids. Liquid and vapour can cause severe damage to skin and eyes.	2079
2186	HYDROGEN CHLORIDE, REFRIGERATED LIQUID	2.3	8	-	900	-	-	-	-	-	-	-	-	-	-	Transport is prohibited.	2186
2187	CARBON DIOXIDE, REFRIGERATED LIQUID	2.2	-	-	-	120 ml	E1	P203	-	-	-	T75	TP5	F-C, S-V	Category D.	Non-flammable, liquefied gas, colourless and odourless. Heavier than air (1.5). Cannot remain in the liquid state above 31°C.	2187
2188	ARSINE	2.3	2.1	-	-	0	E0	P200	-	-	-	-	-	F-D, S-U	Category D. Clear of living quarters.	Flammable, toxic, colourless gas with a garlic odour. Explosive limits: 3.9% to 77.8%. Much heavier than air (2.8).	2188
2189	DICHLOROSILANE	2.3	2.1/8	-	-	0	E0	P200	-	-	-	-	-	F-D, S-U	Category D. Clear of living quarters. "Separated from" acids. 2.1 but "Away from" class 4.3. See 2.2.6.3.2.	Flammable, toxic and corrosive gas. Reacts with water, evolving hydrogen chloride. Highly irritating to skin, eyes and mucous membranes.	2189
2190	OXYGEN DIFLUORIDE, COMPRESSED	2.3	5.1/8	-	-	0	E0	P200	-	-	-	-	-	F-C, S-W	Category D. Keep as dry as reasonably practicable. Clear of living quarters. Segregation as for class 5.1, but "Separated from" class 7.	Non-flammable, toxic and corrosive, colourless gas with a foul odour. Strong oxidizing agent. Reacts slowly with water or moist air to produce poisonous and corrosive fumes. Corrosive to glass and to most metals. Heavier than air (1.9). Highly irritating to skin, eyes and mucous membranes.	2190
2191	SULPHURYL FLUORIDE	2.3	-	-	-	0	E0	P200	-	-	-	-	-	F-C, S-U	Category D. Clear of living quarters.	Non-flammable, toxic, colourless, odourless gas. Reacts with water or moist air to produce sulphuric acid. Much heavier than air (5.5). Irritating to skin, eyes and mucous membranes.	2191
2192	GERMANE	2.3	2.1	-	-	0	E0	P200	-	-	-	-	-	F-D, S-U	Category D. Clear of living quarters.	Flammable, toxic, colourless gas with a pungent odour. Much heavier than air (2.6).	2192
2193	HEXAFLUOROETHANE (REFRIGERANT GAS R 116)	2.2	-	-	-	120 ml	E1	P200	-	-	-	-	-	F-C, S-V	Category A.	Non-flammable, colourless and odourless gas. Much heavier than air (4.8). Cannot remain in liquid state above 24.3°C.	2193
2194	SELENIUM HEXAFLUORIDE	2.3	8	-	-	0	E0	P200	-	-	-	-	-	F-C, S-U	Category D. Clear of living quarters.	Colourless, toxic and corrosive gas. Corrosive to glass and to most metals. Heavier than air. Highly irritating to skin, eyes and mucous membranes.	2194
2195	TELLURIUM HEXAFLUORIDE	2.3	8	-	-	0	E0	P200	-	-	-	-	-	F-C, S-U	Category D. Clear of living quarters.	Non-flammable, toxic and corrosive, colourless gas with an unpleasant odour. Heavier than air. Highly irritating to skin, eyes and mucous membranes. Corrosive to glass and to most metals. Much heavier than air (7.2). Highly irritating to skin, eyes and mucous membranes.	2195
2196	TUNGSTEN HEXAFLUORIDE	2.3	8	-	-	0	E0	P200	-	-	-	-	-	F-C, S-U	Category D. Clear of living quarters.	Non-flammable, toxic and corrosive, colourless, or yellow liquid. Decomposes in water or moist air, evolving highly toxic and corrosive fumes. Corrosive to glass and to most metals. Much heavier than air (10.3). Boiling point: 193°C. Highly irritating to skin, eyes and mucous membranes.	2196
2197	HYDROGEN IODIDE, ANHYDROUS	2.3	8	-	-	0	E0	P200	-	-	-	-	-	F-C, S-U	Category D. Clear of living quarters.	Non-flammable, toxic and corrosive, colourless, gas with a pungent odour. Heavier than air (4.9). Highly irritating to skin, eyes and mucous membranes.	2197

UN No. (1)	PSN (2)	Class No. or Div (5)	Subsidiary Risk(s) (4)	Packing Group (3)	Special Provisions (6)	Limited quantities (7a)	Excepted quantities (7b)	Packing		IBC	
								Instructions (8)	Provisions (9)	Instructions (10)	Provisions (11)
3.1.2		2.0	2.0	2.0, 1.3	3.3	3.4	3.5	4.1, 4	4.1, 4	4.1, 4	4.1, 4

2198 PHOSPHORUS PENTAFLUORIDE 2.3 8 - - 0 EO P200 - - - -

2199 PHOSPHINE 2.3 2.1 - - 0 EO P200 - - - -

2200 PROPADIENE, STABILIZED 2.1 - - - 0 EO P200 - - - -

2201 NITROUS OXIDE, REFRIGERATED LIQUID 2.2 5.1 - - 0 EO P203 - - - -

2202 HYDROGEN SELENIDE, ANHYDROUS 2.3 2.1 - - 0 EO P200 - - - -

2203 SILANE 2.1 - - - 0 EO P200 - - - -

2204 CARBONYL SULPHIDE 2.3 2.1 - - 0 EO P200 - - - -

2205 ADIPONITRILE 6.1 - - III - 5 l P001 LPO1 - IBC03 - - - -

2206 ISOCYANATES, TOXIC, N.O.S. or ISOCYANATE SOLUTION, TOXIC, N.O.S. 6.1 - - II 274 100 ml<sup>l</sup> E4 P001 - IBC02 - - - -

2206 ISOCYANATES, TOXIC, N.O.S. or ISOCYANATE SOLUTION, TOXIC, N.O.S. 6.1 - - III 223 5 l 274 P001 LPO1 - IBC03 - - - -

2208 CALCIUM HYPOCHLORITE, MIXTURE, DRY with more than 10% but not more than 35% available chlorine 5.1 - - III 314 5 kg P002 E1 - IBC03 - - - -

2209 FORMALDEHYDE SOLUTION with not less than 25% formaldehyde 8 - - III - 5 l P001 LPO1 - IBC03 - - - -

2210 MANEB or MANEB PREPARATION with not less than 60% maneb 4.2 4.3 P 273 0 E1 P002 - IBC06 - - - -

# TSFS 2015:66 Bilaga 1

UN No. (16)	Properties and Observations (17)	Portable tanks and bulk containers		Stowage and Segregation (16)	Properties and Observations (17)
		Tank instructions (15)	Provisions (14)		
2196	Non-flammable, toxic and corrosive gas with an irritating odour. Reacts violently with acids, bases, oxidizing agents, organic peroxides, alcohols, glycols and to most metals. Much heavier than air (4.3). Highly irritating to skin, eyes and mucous membranes.	4.2.5 4.3	4.2.5	7.1 to 7.7	(17)

F-C, S-U Category D. Clear of living quarters. Non-flammable, toxic and corrosive gas with an irritating odour. Reacts violently with acids, bases, oxidizing agents, organic peroxides, alcohols, glycols and to most metals. Much heavier than air (4.3). Highly irritating to skin, eyes and mucous membranes.

F-D, S-U Category D. Clear of living quarters. Flammable, toxic, colourless gas with a garlic odour. Ignites spontaneously in air. Heavier than air (1.2). Irritating to skin, eyes and mucous membranes.

F-D, S-U Category B. Clear of living quarters. Liquefied, flammable, colourless gas. Explosive limits: 1.7% to 12%. Boiling point: -34°C. Irritating to skin, eyes and mucous membranes.

E-C, S-W Category D. Clear of living quarters. Liquefied, non-flammable, colourless gas with a slightly sweet odour. Strong oxidizing agent. Heavier than air (1.5). Cannot remain in liquid state above 36.5°C.

F-D, S-U Category D. Clear of living quarters. Flammable, toxic, colourless gas with a disagreeable odour. Much heavier than air (2.8). Highly irritating to skin, eyes and mucous membranes.

F-D, S-U Category E. Clear of living quarters. Flammable, colourless gas with a foul odour. Explosive limits: 1% to 1.09%. Ignites spontaneously in air. Strong oxidizing agent which reacts violently with oxidizing substances. Heavier than air (1.1).

F-D, S-U Category D. Clear of living quarters. Flammable, toxic, colourless gas with a foul odour. Much heavier than air (2.1).

F-A, S-A Category A. Colourless, odourless oil. Decomposes above 83°C, evolving hydrogen cyanide, a highly toxic and flammable gas. Toxic if swallowed, by skin contact or by inhalation.

F-A, S-A Category E. Protected from sources of heat. Clear of living quarters. Liquids with a pungent odour. Impicible with water but react with it to form carbon dioxide. Toxic if swallowed, by skin contact or by inhalation. If under deck, with mechanical ventilation, six air changes per hour, except when carried in closed containers, when two air changes per hour are required. Irritating to skin, eyes and mucous membranes.

F-A, S-A Category E. Protected from sources of heat. Clear of living quarters. See entry above.

F-H, S-Q Category D. Protected from sources of heat. Cargo transport units shall be stowed so as to allow for adequate air circulation throughout the cargo transport unit. Packages are liable to exothermic decomposition at elevated temperatures. This condition may lead to fire or explosion. Decomposition can be initiated by heat or by impurities (e.g. powdered metals (iron, nickel, copper, calcium, magnesium) and their compounds). Liable to heat slowly. Reacts with acids, evolving chlorine, an irritating, corrosive and toxic gas. In the presence of moisture, corrosive to most metals. Dust irritates mucous membranes.

F-A, S-B Category A. Colourless, clear liquid, with a suffocating pungent odour. Usually stabilized with methyl alcohol. Miscible with water. Causes burns to skin, eyes and mucous membranes.

F-G, S-L Category A. Segregation from foodstuffs as in 7.3.4.2.2, 7.6.3.1.2 or 7.7.3.1.1. Yellow powder, liable to heat and to ignite spontaneously in air. May evolve toxic, irritating or flammable fumes when wet, when involved in a fire or in contact with acids. Used as fungicide.

UN No. (1)	PSN (2)	Class or Div (5)	Subsidiary Risk(s) (4)	Packing Group (3)	Special Provisions (6)	Limited quantities (7a)	Excepted quantities (7b)	Packing			IBC	
								Instruc-tions (8)	Instruc-tions (9)	Instruc-tions (10)	Provisions (11)	Provisions (11)
	3.1.2	2.0	2.0	2.0	3.3	3.4	3.5	4.1,4	4.1,4	4.1,4	4.1,4	

UN No. (16)	Properties and Observations (17)	Stowage and Segregation (16)	Portable tanks and bulk containers		Ems (15)
			Tank instructions (15)	Provisions (14)	
		7.1 to 7.7	4.2,5	4.2,5	54,5,2 7,8

2211 POLYMERIC BEADS, EXPANDABLE evolving flammable vapour  
 Category E. Powdered material in bead or granular form consisting predominantly of polyethylene glycol (PE-G) and containing 5% to 8% of a volatile hydrocarbon which is predominantly pentane. During storage a small proportion of this pentane is released to the atmosphere; this proportion increases at elevated temperatures.

2212 BLUE ASBESTOS (crocidolite) or BROWN ASBESTOS (amosite, mpyrite)  
 Category A. Clear of living organisms  
 Category A. When transported in bulk, in a manner, see 7.6.2.12 and 7.7.3.9.

Mineral fibres of varying length. Non-combustible. Inhalation of the dust of asbestos fibres is dangerous and therefore exposure should be avoided at all times. Always prevent the generation of asbestos dust. Crocidolite (blue asbestos) should be regarded as the most hazardous type of asbestos.  
 A safe level of airborne concentration of asbestos fibres may be obtained through effective packing. Cargo spaces or freight containers that have contained any type of raw asbestos should be carefully cleaned before use. The cleaning should be done by trained personnel wearing appropriate repair or maintenance work. Whenever possible, cleaning of cargo spaces should be carried out whilst the ship is in a port where proper facilities and equipment, including proper respiratory apparatus and protective clothing, is available. Parts of the body that may have been exposed to asbestos should be washed thoroughly with soap and water. All dust should be collected in impermeable and sealed bags for safe disposal ashore. If cleaning cannot be carried out at the discharge port, arrangements should be made in advance for cleaning to be carried out at the next port where such facilities are available. All cleaning operations should be carried out at least in accordance with the procedures followed and standard of equipment used must be at least as effective as those which would be employed in a port. Until such cleaning is undertaken, the cargo spaces in which the asbestos has been carried should be closed and access to those spaces should be prohibited.

2213 PARAFORMALDEHYDE  
 Category A. When transported in bulk, in a manner, see 7.6.2.12 and 7.7.3.9.

White powder with a pungent odour. Evolves formaldehyde, particularly when heated, which is irritating to eyes and mucous membranes.

White powder or flakes and lumps containing a high proportion of dust. Melting point: about 53°C. Fumes and dust are irritating to skin, eyes and mucous membranes. Inhalation can cause respiratory trouble.

White powder, needles, flakes, pellets, rods, briquettes, lumps or fused masses. Melting point: about 53°C. Fumes and dust are irritating to skin, eyes and mucous membranes. Inhalation can cause respiratory trouble.

Melting point: about 53°C. The vapour of the molten substance has a flashpoint of 152°C.c.c. and forms a flammable atmosphere with explosive limits of 1.7% to 10.4%. Causes burns to skin, eyes and mucous membranes. May be carried in the molten state. The molten substance can cause severe skin burns.

Melting point: about 53°C. The vapour of the molten substance has a flashpoint of 103°C.c.c. And forms a flammable atmosphere with explosive limits of 1.4% to 7.1%. Fumes are irritating to skin, eyes and mucous membranes.

Brown to greenish-brown product obtained through heating and drying of oily fish. Strong odour which may affect other cargo. Liable to heat spontaneously unless of very low fat content or effectively anti-oxidant treated.

Residue remaining after oil has been extracted by a solvent process from oil-bearing seeds. Used mainly as an animal feed or fertilizer. The most common seed cakes used are those of soybean (soybean cake), rapeseed (rapeseed cake), sunflower (sunflower cake), cottonseed (cottonseed cake), palm kernel, rape seed, rice bran, soyabean and sunflower seed and they may be shipped in the form of cake, flakes, pellets, meal etc. May self-heat slowly if wet and ignite spontaneously. Before shipment, this cargo should be dried to a minimum of 10% moisture content. The seed cake should be substantially free from flammable solvent. Smoking and the use of naked lights should not be allowed during loading and unloading, and on entry to cargo spaces at any other time.

**TSFS 2015:66  
Bilaga 1**

UN No. (1)	PSN (2)	Class or Div (3)	Subsidiary Risk(s) (4)	Packing Group (5)	Special Provisions (6)	Limited quantities (7a)	Excepted quantities (7b)	Packing		IBC		Portable tanks and bulk containers		EMS (15)	Stowage and Segregation (16)	Properties and Observations (17)	UN No. (18)
								Instruc-tions (8)	Provisions (9)	Instruc-tions (10)	Provisions (11)	Tank instructions (12)	Provisions (13)				
2218	ACRYLIC ACID, STABILIZED	8	3	II	-	1 ℓ	E2	P001	-	IBC02	-	T7	TP2	F-E, S-C	Category C: Protected from sources of heat; Clear of living quarters.	Colourless; flammable liquid with an acid odour; Melting point: 13°C; Boiling point: 49°C; Vapour pressure: 1.3 kPa at 20°C; May cause fire and explosion unless properly stabilized. Harmful if swallowed or by inhalation; Corrosive to skin, eyes and mucous membranes.	2218
2219	ALLYL GLYCIDYL ETHER	3	-	III	-	5 ℓ	E1	P001 LP01	-	IBC03	-	T2	TP1	F-E, S-D	Category A.	Colourless liquid; Flashpoint: 48°C c.c. Miscible with water. Harmful by inhalation; Irritating to skin, eyes and mucous membranes.	2219
2222	ANISOLE	3	-	III	-	5 ℓ	E1	P001 LP01	-	IBC03	-	T2	TP1	F-E, S-D	Category A.	Colourless to yellow liquid; Flashpoint: 41°C c.c. Explosive limits: 0.3% to 6.3%; Immiscible with water. Irritating to skin, eyes and mucous membranes.	2222
2224	BENZONITRILE	6.1	-	II	-	100 ml	E4	P001	-	IBC02	-	T7	TP2	F-A, S-A	Category A. Clear of living quarters. Separated from acids.	Colourless liquid with an odour similar to oil of bitter almonds. Reacts with acids, evolving hydrogen cyanide; a highly toxic and flammable gas. Toxic if swallowed; by skin contact or by inhalation.	2224
2225	BENZENESULPHONYL CHLORIDE	8	-	III	-	5 ℓ	E1	P001 LP01	-	IBC03	-	T4	TP1	F-A, S-B	Category A. Clear of living quarters.	Colourless to slightly yellow liquid with a pungent odour. Melting point: 12°C. Immiscible with water; Decomposes slowly in water. Harmful if swallowed or by skin contact; Highly irritating to skin, eyes and mucous membranes.	2225
2226	BENZOTRICHLORIDE	8	-	II	-	1 ℓ	E2	P001	-	IBC02	-	T7	TP2	F-A, S-B	Category A. Clear of living quarters.	Colourless to slightly yellow or brown fuming liquid; Reacts with water, evolving hydrogen chloride, an irritating and corrosive gas apparent as white fumes. In the presence of moisture, corrosive to most metals. Harmful if swallowed; by skin contact or by inhalation. Burns skin and eyes; vapour irritates eyes and mucous membranes.	2226
2227	n-BUTYL METHACRYLATE, STABILIZED	3	-	III	-	5 ℓ	E1	P001 LP01	-	IBC03	-	T2	TP1	F-E, S-D	Category A.	Colourless liquid; Flashpoint: 41°C c.c. Explosive limits: 2% to 8%; Immiscible with water; Irritating to skin, eyes and mucous membranes.	2227
2232	2-CHLOROETHANAL	6.1	-	I	354	0	E0	P602	-	-	-	T20	TP2 TP13 TP37	F-A, S-A	Category D. Clear of living quarters.	Clear colourless liquid with a pungent odour; Miscible with water; Highly toxic if swallowed; by skin contact or by inhalation.	2232
2233	CHLOROANIDINES	6.1	-	III	-	5 kg	E1	P002 LP02	-	IBC08	B3	T1	TP33	F-A, S-A	Category A.	Crystalline solid; Melting point: 52°C. Soluble in water; Toxic if swallowed, by skin contact or by dust inhalation.	2233
2234	CHLOROBENZOTRIFLUORIDES	3	-	III	-	5 ℓ	E1	P001 LP01	-	IBC03	-	T2	TP1	F-E, S-D	Category A. Clear of living quarters.	Colourless liquids with an aromatic odour; Flashpoint: 36°C to 59°C c.c. On contact with moisture, can evolve hydrogen fluoride, which is a toxic and corrosive gas. Harmful by inhalation.	2234
2235	CHLOROBENZYL CHLORIDES, LIQUID	6.1	-	III	-	5 ℓ	E1	P001 LP01	-	IBC03	-	T4	TP1	F-A, S-A	Category A.	Colourless liquid; Immiscible with water; Toxic if swallowed, by skin contact or by inhalation.	2235
2236	3-CHLORO-4-METHYLPHENYLSULFOXYANATE, LIQUID	6.1	-	II	-	100 ml	E4	P001	-	IBC02	-	-	-	F-A, S-A	Category B. Clear of living quarters.	Colourless liquid with a pungent odour; Immiscible with water. Reacts with water, evolving carbon dioxide; Toxic if swallowed, by skin contact or by inhalation; Irritating to skin, eyes and mucous membranes.	2236
2237	CHLOROTRANILINES	6.1	-	III	-	5 kg	E1	P002 LP02	-	IBC08	B3	T1	TP33	F-A, S-A	Category A.	Yellow or orange crystalline powders or needles; Insoluble in water; Toxic if swallowed, by skin contact or by dust inhalation.	2237
2238	CHLOROTOLUENES	3	-	III	-	5 ℓ	E1	P001 LP01	-	IBC03	-	T2	TP1	F-E, S-D	Category A.	Colourless to brown liquids; Flashpoint: 43°C to 47°C c.c. Immiscible with water. When involved in a fire, evolve toxic gases; Harmful by skin contact or by inhalation; Irritating to eyes and mucous membranes.	2238
2239	CHLOROTOLUENES, SOLID	6.1	-	III	-	5 kg	E1	P002 LP02	-	IBC08	B3	T1	TP33	F-A, S-A	Category A.	Crystalline solids. Some isomers may melt at low temperature; melting range between 0°C and 24°C; Toxic if swallowed, by skin contact or by inhalation.	2239



UN No. (1)	PSN (2)	Class or Div (3)	Subsidiary Risk(s) (4)	Packing Group (5)	Special Provisions (6)	Limited quantities (7a)	Excepted quantities (7b)	Packing		IBC		Portable tanks and bulk containers			Properties and Observations (17)	UN No. (18)	
								Class (8)	Subsidiary Risk(s) (9)	Institutions (10)	Provisions (11)	Tank instructions (12)	Provisions (13)	EMS (15)			Stowage and Segregation (16)
	3.1.2	2.0	2.0	2.0, 1.3	3.3	3.4	3.5	4.1, 4	P001	-	-	T10	TP2, TP3	F-A, S-B	Category B. Clear of living quarters. A. Liquid mixture of sulphuric acid and a chromium compound (e.g. chromic acid). Corrosive to steel. Highly corrosive to most metals. Causes severe burns to skin, eyes and mucous membranes.	2240	
2240	CHROMOSULPHURIC ACID																
2241	CYCLOHEPTANE	3	-	II	-	1 ℓ	E2	P001	-	IBC02	-	T4	TP1	F-E, S-D	Category B. Clear of living quarters. Only liquid. Immiscible with water. Narcotic.	2241	
2242	CYCLOHEPTENE	3	-	II	-	1 ℓ	E2	P001	-	IBC02	-	T4	TP1	F-E, S-D	Category B. Only liquid. Immiscible with water.	2242	
2243	CYCLOHEXYL ACETATE	3	-	III	-	5 ℓ	E1	P001, LPO1	-	IBC03	-	T2	TP1	F-E, S-D	Category A. Colourless liquid. Flashpoint: 55°C c.c. Immiscible with water. Irritating to skin, eyes and mucous membranes.	2243	
2244	CYCLOPENTANOL	3	-	III	-	5 ℓ	E1	P001, LPO1	-	IBC03	-	T2	TP1	F-E, S-D	Category A. Colourless, oily liquid. Flashpoint: 51°C c.c. Immiscible with water.	2244	
2245	CYCLOPENTANONE	3	-	III	-	5 ℓ	E1	P001, LPO1	-	IBC03	-	T2	TP1	F-E, S-D	Category A. Colourless liquid. Flashpoint: 31°C c.c. Immiscible with water.	2245	
2246	CYCLOPENTENE	3	-	II	-	1 ℓ	E2	P001	-	IBC02	B8	T7	TP2	F-E, S-D	Category E. Colourless liquid. Flashpoint: -30°C c.c. Boiling point: 44°C. Immiscible with water. Irritating to skin, eyes and mucous membranes. Narcotic.	2246	
2247	n-DECANE	3	-	III	-	5 ℓ	E1	P001, LPO1	-	IBC03	-	T2	TP1	F-E, S-E	Category A. Colourless liquid. Flashpoint: 47°C c.c. Explosive limits: 0.0% to 5.5%. Immiscible with water.	2247	
2248	DI-n-BUTYLAMINE	8	3	II	-	1 ℓ	E2	P001	-	IBC02	-	T7	TP2	F-E, S-C	Category A. Colourless, flammable liquid with an amine odour. Flashpoint: 39°C c.c. Boiling point: 68°C. Immiscible with water. Corrosive to skin, eyes and mucous membranes. Vapour irritates mucous membranes.	2248	
2249	DICHLORDIMETHYL ETHER, SYMMETRICAL	6.1	3	I	76	0	E5	P099	-	-	-	-	-	F-E, S-D	Category D. Clear of living quarters. Colourless, volatile, flammable liquid. Flashpoint: 42°C c.c. Immiscible with water. Decomposed by heat and water. Highly toxic if swallowed, by skin contact or by inhalation. The transport of this substance is prohibited except with special authorization granted by the competent authorities.	2249	
2250	DICHLOROPHENYL ISOCYANATES	6.1	-	II	-	500 g	E4	P002	-	IBC08	B2, B4	T3	TP3	F-A, S-A	Category B. Protected from sources of heat. Clear of living quarters. Colourless to yellowish crystalline solid with an irritating odour. Insoluble in water. Reacts with water, evolving carbon dioxide. Toxic if swallowed, by skin contact or by inhalation. Irritating to skin, eyes and mucous membranes.	2250	
2251	BICYCLO[2.2.1]HEPTA-2,5-DIENE, STABILIZED (2,5-NORBORNADIENE, STABILIZED)	3	-	II	-	1 ℓ	E2	P001	-	IBC02	-	T7	TP2	F-E, S-D	Category D. Colourless, volatile liquid. Flashpoint: below -18°C c.c. Explosive limits: 1.7% to 6.3%. Immiscible with water.	2251	
2252	1,2-DIMETHOXYETHANE	3	-	II	-	1 ℓ	E2	P001	-	IBC02	-	T4	TP1	F-E, S-D	Category B. Colourless liquid with an ethereal odour. Flashpoint: 1°C c.c. Miscible with water.	2252	
2253	N,N-DIMETHYLANILINE	6.1	-	II	-	100 ml	E4	P001	-	IBC02	-	T7	TP2	F-A, S-A	Category A. Yellowish to brownish oily liquid. Combustible. Toxic if swallowed, by skin contact or by inhalation.	2253	
2254	MATCHES, FUSE	4.1	-	III	293	5 kg	E1	P407	-	-	-	-	-	F-A, S-I	Category A. Matches, the heads of which are prepared with a friction-sensitive igniter composition and a pyrotechnic composition which burns with little or no flame, but with intense heat, regardless of wind or other weather conditions.	2254	
2256	CYCLOHEXENE	3	-	II	-	1 ℓ	E2	P001	-	IBC02	-	T4	TP1	F-E, S-D	Category E. Colourless liquid with an aromatic odour. Immiscible with water. Slightly irritating to skin, eyes and mucous membranes.	2256	

UN No. (1)	PSN (2)	Class or Div (3)	Subsidiary Risk(s) (4)	Packing Group (5)	Special Provisions (6)	Limited quantities (7a)	Excepted quantities (7b)	Packing		IBC	
								Instruc-tions (8)	Provisions (9)	Instruc-tions (10)	Provisions (11)
3.1.2		2.0	2.0	2.0	3.3	3.4	3.5	4.1, 4	4.1, 4	4.1, 4	

2257 POTASSIUM Category D. "Separated from" acids. Soft, silvery metal, solid or liquid. Flalts on water. Reacts violently with water, especially with acids. Highly reactive, sometimes with explosive effect. 2257

2258 1,2-PROPYLENEDIAMINE Colourless, flammable liquid with an ammoniacal odour. Flashpoint: range 33°C to 48°C. Miscible with water. When involved in fire, evolves toxic gases. Harmful by inhalation. Causes burns to skin and eyes. Irritating to mucous membranes. 2258

2259 TRIETHYLENEDIAMINE Moderately viscous, yellow combustible liquid with an ammoniacal odour. Miscible with water. Strongly alkaline. Can form explosive mixtures with nitric acid. When involved in a fire, evolves toxic gases. Corrosive to copper and other alloys. Harmful by inhalation. Causes skin allergies and burns to skin, eyes and mucous membranes. Causes skin allergies. 2259

2260 TRIISOPROPYLAMINE Colourless liquid. Flashpoint: 35°C c.c. Paraffin, miscible with water. When involved in fire, evolves toxic gases. Harmful by inhalation. Causes burns to skin and eyes. Irritating to mucous membranes. 2260

2261 XYLENOLS, SOLID Crystals or needles. Toxic if swallowed, by skin contact or by inhalation. 2261

2262 DIMETHYLCARBAMOYL CHLORIDE Colourless to yellow liquid with a pungent odour. Immiscible with water. Reacts with water, evolving toxic and corrosive fumes. Causes tears. Causes burns to skin, eyes and mucous membranes. 2262

2263 DIMETHYLCYCLOHEXANES Colourless liquids. Flashpoint: 5°C c.c. Immiscible with water. 2263

2264 N,N-DIMETHYLCYCLOHEXYLAMINE Colourless, flammable liquid. Flashpoint: 43°C c.c. Partially miscible with water. Causes burns to skin, eyes and mucous membranes. 2264

2265 N,N-DIMETHYLFORMAMIDE Colourless liquid. Flashpoint: 58°C c.c. Explosive limits: 2.2% to 16%. Miscible with water. May react violently with oxidizing materials. 2265

2266 DIMETHYL N-PROPYLAMINE Colourless liquid with a fishy odour. Flashpoint: -11°C c.c. Miscible with water. Harmful by inhalation. Causes burns to skin, eyes and mucous membranes. 2266

2267 DIMETHYL THIOPHOSPHORYL CHLORIDE Colourless, combustible liquid with a pungent odour. Reacts slowly with water, evolving hydrogen chloride, a corrosive gas apparent as white fumes. May decompose above 60°C, evolving flammable gases. Toxic if swallowed, in contact or by inhalation. Causes burns to skin, eyes and mucous membranes. 2267

2269 3,3'-MINODIPIROPYLAMINE Colourless combustible liquid. Miscible with water. Harmful if swallowed or by inhalation. Corrosive to skin, eyes and mucous membranes. 2269

2270 ETHYLAMINE AQUEOUS SOLUTION with not less than 50% but not more than 70% ethylamine Aqueous solution of a flammable gas with an amoniacal odour. Explosive limits: 9.5% to 14%. ETHYLAMINE SOLUTION, concentration 50%; flashpoint -11°C c.c.; boiling point 56°C. Pure ETHYLAMINE, boiling point 17°C. Miscible with water. Harmful by inhalation. Causes burns to skin, eyes and mucous membranes. Reacts violently with acids. 2270

2271 ETHYLAMYL-KETONES Colourless liquids. Vapour is much heavier than air (4-A, ETHYL-NORMAL-AMYLKETONE; flashpoint 43°C c.c. ETHYL-SECONDARY-AMYLKETONE; flashpoint 43°C c.c. ETHYL-TERTIARY-AMYLKETONE). Harmful by inhalation. Causes burns to skin, eyes and mucous membranes. Irritating to skin, eyes and mucous membranes. 2271

2272 N-ETHYLANILINE Colourless to yellowish oily liquid. Reacts with acids, evolving highly toxic fumes of amine and oxides of nitrogen. Reacts violently with oxidizing substances. Toxic if swallowed, by skin contact or by inhalation. 2272

Portable tanks and bulk containers		EMs No. (15)	Storage and Segregation (16)	Properties and Observations (17)	UN No. (18)
Tank instructions (15)	Provisions (14)				
4.2.5 4.3	4.2.5	54.5.2 7.8	7.1 to 7.7	(17)	

T9 TP7 F-C, S-N Category D. "Separated from" acids. Soft, silvery metal, solid or liquid. Flalts on water. Reacts violently with water, especially with acids. Highly reactive, sometimes with explosive effect. TP3

T7 TP2 F-E, S-C Category A. Clear of living quarters.

T7 TP2 F-A, S-B Category B. Clear of living quarters. "Separated from" acids.

T4 TP1 F-E, S-C Category A. Clear of living quarters.

T3 TP33 F-A, S-A Category A.

T7 TP2 F-A, S-B Category A. Clear of living quarters.

T4 TP1 F-E, S-D Category B.

T7 TP2 F-E, S-C Category A. Clear of living quarters.

T2 TP2 F-E, S-D Category A.

T7 TP2 TP13 F-E, S-C Category B. Clear of living quarters.

T7 TP2 F-A, S-B Category B. Protected from sources of heat.

T4 TP2 F-A, S-B Category A.

T7 TP1 F-E, S-C Category B. Clear of living quarters. "Separated from" acids.

T2 TP1 F-E, S-D Category A.

T4 TP1 F-A, S-A Category A. "Separated from" acids and Class 5.1.

UN No. (1)	PSN (2)	Class No. (3)	Subsidiary Risk(s) (4)	Packing Group (5)	Special Provisions (6)	Limited quantities (7a)	Excepted quantities (7b)	Packing			IBC			UN No. (18)
								Class (8)	Provisions (9)	Institutions (10)	Provisions (11)	IBC (12)	Institutions (13)	
	3.1.2	2.0	2.0	2.0, 1.3	3.3	3.4	3.5	4.1, 4	4.1, 4	P001 LPO1	-	IBC03	-	
2273	2-ETHYLANILINE	6.1	-	III	-	5 ℓ	E1	P001 LPO1	-	IBC03	-			2273
2274	N-ETHYL-N-BENZYLANILINE	6.1	-	III	-	5 ℓ	E1	P001 LPO1	-	IBC03	-			2274
2275	2-ETHYLBUTANOL	3	-	III	-	5 ℓ	E1	P001 LPO1	-	IBC03	-			2275
2276	2-ETHYLHEXYLAMINE	3	8	III	-	5 ℓ	E1	P001	-	IBC03	-			2276
2277	ETHYL METHACRYLATE, STABILIZED	3	-	II	-	1 ℓ	E2	P001	-	IBC02	-			2277
2278	n-HEPTENE	3	-	II	-	1 ℓ	E2	P001	-	IBC02	-			2278
2279	HEXACHLOROBUTADIENE	6.1	-	III	-	5 ℓ	E1	P001 LPO1	-	IBC03	-			2279
2280	HEXAMETHYLENEDIAMINE, MOLTEN	8	-	III	-	0	E1	-	-	-	-			2280
2280	HEXAMETHYLENEDIAMINE, SOLID	8	-	III	-	5 kg	E1	P002 LPO2	-	IBC08	B3			2280
2281	HEXAMETHYLENE DIISOCYANATE	6.1	-	II	-	100 ml	E4	P001	-	IBC02	-			2281
2282	HEXANOLS	3	-	III	-	5 ℓ	E1	P001 LPO1	-	IBC03	-			2282
2283	ISOBUTYL METHACRYLATE, STABILIZED	3	-	III	-	5 ℓ	E1	P001 LPO1	-	IBC03	-			2283
2284	ISOBUTYRONITRILE	3	6.1	II	-	1 ℓ	E2	P001	-	IBC02	-			2284
2285	ISOCYANATOBENZOTRIFLUORIDES	6.1	3	II	-	100 ml	E4	P001	-	IBC02	-			2285
2286	PENTAMETHYLHEPTANE	3	-	III	-	5 ℓ	E1	P001 LPO1	-	IBC03	-			2286
2287	ISOHEPTENES	3	-	II	-	1 ℓ	E2	P001	-	IBC02	-			2287

UN No. (18)	Properties and Observations (17)	Stowage and Segregation (16)	EMs (15)	Portable tanks and bulk containers		Category A, *Separated from acids and Class 3.1.
				Tank instructions (13)	Provisions (14)	
(18)	(17)	7.1 to 7.7	(15)	4.2, 5	4.3	F-A, S-A
2273	Brown liquid. Immiscible with water. Reacts with acids, evolving highly oxidizing substances. Toxic if swallowed, by skin contact or by inhalation.		F-A, S-A	TP1	T4	
2274	Light yellow, oily liquid. Immiscible with water. Toxic if swallowed, by skin contact or by inhalation.		F-A, S-A	TP1	T4	
2275	Colourless liquid. Flashpoint: 57°C o.c. Immiscible with water.		F-E, S-D	TP1	T2	
2276	Colourless liquid. Flashpoint: 50°C c.c. Miscible with water. Irritating to skin, eyes and mucous membranes.		F-E, S-C	TP1	T4	
2277	Colourless liquid with a pungent odour. Flashpoint: 20°C o.c. Explosive limits: 1.8% to ... Immiscible with water. Irritating to skin, eyes and mucous membranes.		F-E, S-D	TP1	T4	
2278	Colourless liquid. Flashpoint: -3°C c.c. Immiscible with water.		F-E, S-D	TP1	T4	
2279	Colourless liquid. Immiscible with water. Toxic if swallowed, by skin contact or by inhalation.		F-A, S-A	TP1	T4	
2280	White crystals or shiny flakes with a specific odour. Insoluble in water. Decomposes when heated, evolving flammable and toxic gases. Causes burns to skin, eyes and mucous membranes. See entry above.		F-A, S-B	TP33	T1	
2281	Colourless to light yellow liquid with a pungent odour. Immiscible with water but reacts with it, evolving heat and carbon dioxide gas. When heated, evolves toxic nitrous fumes. Toxic if swallowed, by skin contact or by inhalation. Irritating to skin, eyes and mucous membranes.		F-A, S-A	TP2, TP3	T7	
2282	Colourless liquids, normal-HEXANOL; flashpoint 57°C c.c. Miscible with water.		F-E, S-D	TP1	T2	
2283	Colourless liquid. Flashpoint: 49°C c.c. Immiscible with water. Irritating to skin, eyes and mucous membranes.		F-E, S-D	TP1	T2	
2284	Colourless liquid. Flashpoint: 8°C c.c. Immiscible with water. Toxic by skin contact or by inhalation.		F-E, S-D	TP2, TP3	T7	
2285	Colourless or yellowish liquids with a pungent odour. Flashpoint of ortho- and meta- isomers: 5°C. Immiscible with water, but miscible with alcohol. Irritating to skin, eyes and mucous membranes. Contact or by inhalation. Irritating to skin, eyes and mucous membranes.		F-E, S-D	TP2	T7	
2286	Colourless liquid. Flashpoint: 43°C c.c. Immiscible with water.		F-E, S-D	TP1	T2	
2287	Colourless liquids. Immiscible with water.		F-E, S-D	TP1	T4	

**TSFS 2015:66  
Bilaga 1**

UN No. (1)	PSN (2)	Class No. (3)	Subsidiary Risk(s) (4)	Packing Group (5)	Special Provisions (6)	Limited quantities (7a)	Excepted quantities (7b)	Packing		IBC		Portable tanks and bulk containers			Properties and Observations (17)	UN No. (18)	
								Class or Div (5)	Inst. (8)	Provisions (9)	Inst. (10)	Provisions (11)	Tank instructions (12)	Provisions (13)			EMs (15)
3.1.2		2.0	2.0	2.0, 1.3	3.3	3.4	3.5	4.1, 4	4.1, 4	4.1, 4	4.1, 4	T1	TP1	F-E, S-D	Category E	Colourless liquids. Boiling range: 54°C to 69°C. Immiscible with water.	Z288
2288	ISOBHEMIS	3	-	II	-	1 ℓ	E2	P001	-	IBC02	B8	T11	TP1	F-E, S-D	Category E	Colourless liquids. Boiling range: 54°C to 69°C. Immiscible with water.	Z288
2289	ISOPHORONEDIAMINE	8	-	III	-	5 ℓ	E1	P001 LP01	-	IBC03	-	T4	TP1	F-A, S-B	Category A.	Colourless, slightly hygroscopic liquid with a slight amine odour. Combustible. Miscible with water. Harmful if swallowed. Irritating to skin, eyes and mucous membranes.	Z289
2290	ISOPHORONE DIISOCYANATE	6.1	-	III	-	5 ℓ	E1	P001 LP01	-	IBC03	-	T4	TP2	F-A, S-A	Category B. Clear of living quarters.	Colourless or yellowish liquid. Immiscible with water. When involved in a fire, evolves nitrous fumes. Toxic if swallowed, by skin contact or by inhalation. Irritating to skin, eyes and mucous membranes.	Z290
2291	LEAD COMPOUND, SOLUBLE, N.O.S.	6.1	-	III	199 274	5 kg	E1	P002 LP02	-	IBC08	B3	T1	TP3	F-A, S-A	Category A.	Colourless crystals or powder. Soluble in water. Toxic if swallowed, by skin contact or by dust inhalation.	Z291
2293	4-METHOXY-4-METHYLPENTAN-2-ONE	3	-	III	-	5 ℓ	E1	P001 LP01	-	IBC03	-	T2	TP1	F-E, S-D	Category A.	Colourless liquid. Flashpoint: -49°C c.c. Immiscible with water.	Z293
2294	N-METHYLANILINE	6.1	-	III	-	5 ℓ	E1	P001 LP01	-	IBC03	-	T4	TP1	F-A, S-A	Category A.	Colourless to brown combustible liquid. Toxic if swallowed, by skin contact or by inhalation.	Z294
2295	METHYLCHLORACETATE	6.1	3	I	-	0	E5	P001	-	-	-	T1, 4	TP2 TP3	F-E, S-D	Category D.	Colourless, flammable liquid with a pungent odour. Flashpoint: 47°C c.c. Immiscible with water. Highly toxic if swallowed, by skin contact or by inhalation.	Z295
2296	METHYLCYCLOHEXANE	3	-	II	-	1 ℓ	E2	P001	-	IBC02	-	T4	TP1	F-E, S-D	Category B.	Colourless liquid. Flashpoint: -4°C c.c. Explosive limits: 1.2% to 6.7%. Immiscible with water. Irritating to skin, eyes and mucous membranes.	Z296
2297	METHYLCYCLOHEXANONE	3	-	III	-	5 ℓ	E1	P001 LP01	-	IBC03	-	T2	TP1	F-E, S-D	Category A.	Colourless to pale yellow liquids with a sweet odour. 2-METHYLCYCLOHEXANONE: Flashpoint 46°C c.c. 4-METHYLCYCLOHEXANONE: Flashpoint 51°C c.c. Immiscible with water.	Z297
2298	METHYLCYCLOPENTANE	3	-	II	-	1 ℓ	E2	P001	-	IBC02	-	T4	TP1	F-E, S-D	Category B.	Colourless liquid. Flashpoint: below 10°C c.c. Explosive limits: 1% to 8.4%. Immiscible with water. Irritating to skin, eyes and mucous membranes.	Z298
2299	METHYLDICHLOROACETATE	6.1	-	III	-	5 ℓ	E1	P001 LP01	-	IBC03	-	T4	TP1	F-A, S-A	Category A.	Liquid. Toxic if swallowed, by skin contact or by inhalation.	Z299
2300	2-METHYL-5-ETHYLPYRIDINE	6.1	-	III	-	5 ℓ	E1	P001 LP01	-	IBC03	-	T4	TP1	F-A, S-A	Category A.	Colourless liquid with a pungent odour. Toxic if swallowed, by skin contact or by inhalation.	Z300
2301	2-METHYLFURAN	3	-	II	-	1 ℓ	E2	P001	-	IBC02	-	T4	TP1	F-E, S-D	Category E.	Colourless liquid with a sweetish odour. Flashpoint: -30°C c.c. Immiscible with water. Toxic if swallowed, by skin contact or by inhalation. Irritating to skin, eyes and mucous membranes.	Z301
2302	5-METHYLHEXAN-2-ONE	3	-	III	-	5 ℓ	E1	P001 LP01	-	IBC03	-	T2	TP1	F-E, S-D	Category A.	Colourless liquid. Flashpoint: 43°C c.c. Immiscible with water.	Z302
2303	ISOPROPENYLBENZENE	3	-	III	-	5 ℓ	E1	P001 LP01	-	IBC03	-	T2	TP1	F-E, S-D	Category A.	Colourless liquid. Flashpoint: 38°C to 54°C c.c. Explosive limits: 0.7% to 6.6%. Immiscible with water. Irritating to skin, eyes and mucous membranes.	Z303

UN No. (1)	PSN (2)	Class No. (3)	Subsidiary Risk(s) (4)	Packing Group (5)	Special Provisions (6)	Limited quantities (7a)	Excepted quantities (7b)	Packing			IBC			Provisional instructions (15)	Tank instructions (16)	Stowage and Segregation (16)	Properties and Observations (17)	UN No. (18)
								Class (8)	Subsidiary Risk(s) (9)	Provisions (10)	Instructions (11)	Provisions (12)	Institutions (13)					
	3.1.2	2.0	2.0	2.0, 1.3	3.3	3.4	3.5	4.1, 4	4.1, 4	4.1, 4	4.1, 4	4.1, 4	4.2, 5	4.2, 5	54, 5, 2	7.1 to 7.7		
2304	MARPHALENE, MOLTEN	4.1	-	III	-	0	EO	-	-	-	-	-	TI	TP3	F-A, S-H	Category C.	Molten liquid with a persistent odour. Melting point: 80°C. Evolves very toxic fumes. Contact with water may cause violent foaming very close to its flashpoint. Care should be taken to avoid all possible causes of ignition. Contact between water and molten naphthalene above 110°C must be avoided, as the addition of water will cause violent foaming or even an explosion.	2304
2305	NITROBENZENSULPHONIC ACID	8	-	II	-	1 kg	E2	P002	-	IBC08	B2	B4	T3	TP3	F-A, S-B	Category A.	Crystals. Soluble in water. Causes burns to skin, eyes and mucous membranes.	2305
2306	NITROBENZOTRIFLUORIDES, LIQUID	6.1	-	II	-	100 ml	E4	P001	-	IBC02	-	-	T7	TP2	F-A, S-A	Category A.	Pale straw-coloured, oily liquids with an aromatic odour. Immiscible with water. Toxic if swallowed, by skin contact or by inhalation.	2306
2307	3-NITRO-4-CHLOROBENZOTRIFLUORIDE	6.1	-	II	-	100 ml	E4	P001	-	IBC02	-	-	T7	TP2	F-A, S-A	Category A.	Yellowish, oily liquid. Immiscible with water. Toxic if swallowed, by skin contact or by inhalation.	2307
2308	NITROSYLSULPHURIC ACID, LIQUID	8	-	II	-	1 l	E2	P001	-	IBC02	B20	-	T8	TP2	F-A, S-B	Category D.	Clear, straw-coloured, oily liquid. Oxidant which may cause fire with organic materials. Causes burns to skin, eyes and mucous membranes. Evolves toxic gases in the presence of moisture. Highly corrosive to most metals. Causes burns to skin, eyes and mucous membranes.	2308
2309	OCTADIENE	3	-	II	-	1 l	E2	P001	-	IBC02	-	-	T4	TP1	F-E, S-D	Category B.	Colourless liquid. Flashpoint: 9°C to 15°C c.c. Immiscible with water.	2309
2310	PENTANE-2,4-DIONE	3	6.1	III	-	5 l	E1	P001	-	IBC03	-	-	T4	TP1	F-E, S-D	Category A.	Colourless liquid. Flashpoint: 34°C c.c. Explosive limits: 1.7% to ... Miscible with water. Toxic if swallowed, by skin contact or by inhalation.	2310
2311	PHENETIDINES	6.1	-	III	-	5 l	E1	P001	LP01	IBC03	-	-	T4	TP1	F-A, S-A	Category A.	Colourless to yellowish liquids. Immiscible with water. Toxic if swallowed, by skin contact or by inhalation.	2311
2312	PHENOL, MOLTEN	6.1	-	II	-	0	EO	-	-	-	-	-	T7	TP3	F-A, S-A	Category B.	Molten liquid with a distinctive strong odour. Melting point: 10°C to 43°C (pure product). Toxic if swallowed, by skin contact or by inhalation. Rapidly absorbed through the skin.	2312
2313	PICOLINES	3	-	III	-	5 l	E1	P001	LP01	IBC03	-	-	T4	TP1	F-E, S-D	Category A.	Colourless to yellow liquids with a pungent or sweet odour. Flashpoint: 15°C c.c. (pure product). Toxic if swallowed, by skin contact or by inhalation. Alpha-picoline flashpoint: 28°C c.c. Beta-picoline flashpoint: 40°C c.c. gamma-picoline flashpoint: 40°C c.c. Irritating to skin, eyes and mucous membranes.	2313
2315	POLYCHLORINATED BIPHENYLS, LIQUID	9	-	II	-	305	E2	P906	-	IBC02	-	-	T4	TP1	F-A, S-A	Category A.	Colourless liquid (pure product) with perceptible odour. Immiscible with water. Harmful by ingestion or by skin contact, if spilled can be a persistent hazard to the environment. This entry also covers arylides, such as biphenyls.	2315
2316	SODIUM CUPROCYANIDE, SOLID	6.1	-	I	-	0	ES	P002	-	IBC07	B1	-	T6	TP3	F-A, S-A	Category A.	White powder. Soluble in water. Reacts with acids or acid fumes, evolving hydrogen cyanide, a highly toxic and flammable gas. Highly toxic if swallowed, by skin contact or by dust inhalation.	2316
2317	SODIUM CUPROCYANIDE SOLUTION	6.1	-	I	-	0	ES	P001	-	-	-	-	T14	TP2	F-A, S-A	Category B.	Colourless liquid. Miscible with water. Decomposed by acids, evolving hydrogen cyanide, a highly toxic and flammable gas. Highly toxic if swallowed, by skin contact or by inhalation.	2317
2318	SODIUM HYDROSULPHIDE with less than 25% water of crystallisation	4.2	-	II	-	0	E2	P410	PP3	IBC06	B2	-	T3	TP3	F-A, S-J	Category A.	Colourless needles to lemon-coloured flakes. Soluble in water. Reacts violently with acids.	2318
2319	TERPENE HYDROCARBONS, N.O.S.	3	-	III	-	5 l	E1	P001	LP01	IBC03	-	-	T4	TP1	F-E, S-D	Category A.	Colourless or yellowish liquids. Flashpoint: 32°C to 49°C c.c. Immiscible with water.	2319
2320	TETRAETHYLENEPENTAMINE	8	-	III	-	5 l	E1	P001	LP01	IBC03	-	-	T4	TP1	F-A, S-B	Category A.	Viscous liquid. Miscible with water. When involved in a fire, evolves toxic gases. Causes burns to skin, eyes and mucous membranes. Reacts violently with acids.	2320

**TSFS 2015:66  
Bilaga 1**

UN No. (1)	PSN (2)	Class No. or Div (3)	Subsidiary Risk(s) (4)	Packing Group (5)	Special Provisions (6)	Limited quantities (7a)	Excepted quantities (7b)	Packing		IBC	
								Instruc-tions (8)	Provisions (9)	Instruc-tions (10)	Provisions (11)
3.1.2		2.0	2.0	2.0	1.3	3.3	3.4	3.5	4.1, 4	4.1, 4	4.1, 4
6.1		P		III			5 ℓ	E1	P001 LPO1		IBC03

2321 TRICHLOROENZIMES, LIQUID  
6.1 - P - III - 5 ℓ E1 P001 LPO1 - IBC03 -

2322 TRICHLOROBUTENE  
6.1 - P - II - 100 ml E4 P001 - IBC02 -

2323 TRIETHYL PHOSPHITE  
3 - - III - 5 ℓ E1 P001 LPO1 - IBC03 -

2324 TRIISOBUTYLENE  
3 - - III - 5 ℓ E1 P001 LPO1 - IBC03 -

2325 1, 3, 5-TRIMETHYLBENZENE  
3 - - III - 5 L E1 P001 LPO1 - IBC03 -

2326 TRIMETHYLCYCLOHEXYLAMINE  
8 - - III - 5 ℓ E1 P001 LPO1 - IBC03 -

2327 TRIMETHYLHEXAMETHYLENEDIAMINES  
8 - - III - 5 ℓ E1 P001 LPO1 - IBC03 -

2328 TRIMETHYLHEXAMETHYLENEDIISOCYANATE  
6.1 - - III - 5 ℓ E1 P001 LPO1 - IBC03 -

2329 TRIMETHYL PHOSPHITE  
3 - - III - 5 ℓ E1 P001 LPO1 - IBC03 -

2330 UNDECANE  
3 - - III - 5 ℓ E1 P001 LPO1 - IBC03 -

2331 ZINC CHLORIDE, ANHYDROUS  
8 - - III - 5 kg E1 P002 LPO2 - IBC08 B3

2332 ACETALDEHYDE OXIME  
3 - - III - 5 ℓ E1 P001 LPO1 - IBC03 -

2333 ALLYL ACETATE  
3 6.1 II - 1 ℓ E2 P001 - IBC02 -

2334 ALLYLAMINE  
6.1 3 I 354 0 E0 P602 - - -

2335 ALLYL ETHYL ETHER  
3 6.1 II - 1 ℓ E2 P001 - IBC02 -

Tank instructions (15)	Provisions (14)	EMs (15)	Stowage and Segregation (16)	Properties and Observations (17)	UN No. (18)

Colourless liquids. Immiscible with water. Toxic if swallowed, by skin contact or by inhalation.  
T4 TP1 F-A, S-A Category A.

Colourless liquid. Immiscible with water. When heated, develops toxic and irritant gases, as phosgene, phosgene chloride and phosgene also explodes. Toxic if swallowed, by skin contact or by inhalation.  
T7 TP2 F-A, S-A Category A. Protected from sources of heat. Clear at living quarters.

Colourless liquid. Flashpoint: 44°C c.c. Immiscible with water. Irritating to skin, eyes and mucous membranes.  
T2 TP1 F-E, S-D Category A.

Colourless liquid. Immiscible with water.  
T4 TP1 F-E, S-D Category A.

Colourless liquid. Flashpoint: 44°C c.c. Immiscible with water. Harmful by inhalation.  
T2 TP1 F-E, S-D Category A.

Colourless, slightly hygroscopic, combustible liquid with a slight amine odour. Immiscible with water. Causes burns to skin, eyes and mucous membranes.  
T4 TP1 F-A, S-B Category A.

Colourless, slightly hygroscopic, combustible liquids. Miscible with water. Irritating to skin, eyes and mucous membranes.  
T4 TP1 F-A, S-B Category A.

Colourless or yellowish liquid. Reacts with water, evolving carbon dioxide. Toxic if swallowed, by skin contact or by inhalation. Irritating to skin, eyes and mucous membranes.  
T4 TP2 TP3 F-A, S-A Category B.

Colourless liquid. Flashpoint: 23°C c.c. Immiscible with water. Irritating to skin, eyes and mucous membranes.  
T2 TP1 F-E, S-D Category A.

Colourless liquid. Flashpoint: 60°C c.c. Immiscible with water.  
T2 TP1 F-E, S-E Category A.

White, deliquescent crystals. Soluble in water. Dust causes burns to skin, eyes and mucous membranes.  
T1 TP3 F-A, S-B Category A.

Colourless liquid. Flashpoint: 40°C c.c. Explosive limits: 4.2% to 52%. Freezing point 1.2°C. Miscible with water. Irritating to skin, eyes and mucous membranes.  
T4 TP1 F-E, S-D Category A.

Colourless liquid. Flashpoint: 7°C c.c. Partially miscible with water. Toxic if swallowed, by skin contact or by inhalation. Harmful if swallowed.  
T7 TP1 TP3 F-E, S-D Category E. Clear of living quarters.

Colourless to light yellow volatile liquid with a pungent odour. Flashpoint: 29°C c.c. Explosive limits: 2.2% to 2.2%. Boiling range: 55°C to 88°C. Miscible with water. When involved in a fire, evolves highly toxic gases. Highly toxic if swallowed, by skin contact or by inhalation.  
T20 TP2 TP3 TP3 F-E, S-D Category D. Clear of living quarters.

Colourless liquid. Flashpoint: -11°C c.c. Vapour heavier than air. Immiscible with water. Narcotic. Toxic if swallowed, by skin contact or by inhalation.  
T7 TP1 TP3 F-E, S-D Category E. Clear of living quarters.

UN No. (1)	PSN (2)	Class No. (3)	Subsidiary Risk(s) (4)	Packing Group (5)	Special Provisions (6)	Limited quantities (7a)	Excepted quantities (7b)	Packing			IBC	
								Instruc-tions (8)	Provisions (9)	Instruc-tions (10)	Provisions (11)	
3.1.2		2.0	2.0	2.0	1.3	3.3	3.4	3.5	4.1, 4	4.1, 4	4.1, 4	

2336 ALLYL FORMATE Category E. Clear of living quarters. Colourless liquid. Immiscible with water. Highly toxic if swallowed, by skin contact or by inhalation. T14 TP2 F-E, S-D T13

2337 PHENYL MERCAPTAN Category D. Clear of living quarters. Separated from acids. TP35 F-E, S-D T20

2338 BENZOTRIFLUORIDE Category B. Clear of living quarters. T4 TP1 F-E, S-D

2339 2-BROMOBUTANE Category B. Clear of living quarters. T4 TP1 F-E, S-D

2340 2-BROMOETHYL ETHYL ETHER Category B. Clear of living quarters. T4 TP1 F-E, S-D

2341 1-BROMO-3-METHYLBUTANE Category A. T2 TP1 F-E, S-D

2342 BROMOMETHYPROPANES Category B. T4 TP1 F-E, S-D

2343 2-BROMOPENTANE Category B. T4 TP1 F-E, S-D

2344 BROMOPROPANES Category B. Clear of living quarters. T4 TP1 F-E, S-D

2344 BROMOPROPANES Category A. T2 TP1 F-E, S-D

2345 3-BROMOPROPYNE Category D. Clear of living quarters. T4 TP1 F-E, S-D

2346 BUTANEDIONE Category B. T4 TP1 F-E, S-D

2347 BUTYL MERCAPTAN Category B. "Separated from" acids. T4 TP1 F-E, S-D

2348 BUTYL ACRYLATES, STABILIZED Category A. T2 TP1 F-E, S-D

2350 BUTYL METHYL ETHER Category B. T4 TP1 F-E, S-D

UN No. (16)	Properties and Observations (17)	Storage and Segregation (16)	Portable tanks and bulk containers	
			Provisions (15)	EMs (15)
		7.1 to 7.7	4.2, 5 4.3	4.2, 5 7.8

Category E. Clear of living quarters. Colourless liquid. Immiscible with water. Highly toxic if swallowed, by skin contact or by inhalation. T14 TP2 F-E, S-D T13

Category D. Clear of living quarters. Separated from acids. TP35 F-E, S-D T20

Category B. Clear of living quarters. T4 TP1 F-E, S-D

Category B. Clear of living quarters. T4 TP1 F-E, S-D

Category B. Clear of living quarters. T4 TP1 F-E, S-D

Category A. T2 TP1 F-E, S-D

Category B. T4 TP1 F-E, S-D

Category B. Clear of living quarters. T4 TP1 F-E, S-D

Category A. T2 TP1 F-E, S-D

Category B. T4 TP1 F-E, S-D

Category D. Clear of living quarters. T4 TP1 F-E, S-D

Category B. T4 TP1 F-E, S-D

Category B. Clear of living quarters. T4 TP1 F-E, S-D

Category A. T2 TP1 F-E, S-D

Category D. Clear of living quarters. T4 TP1 F-E, S-D

Category B. T4 TP1 F-E, S-D

Category B. "Separated from" acids. T4 TP1 F-E, S-D

Category A. T2 TP1 F-E, S-D

Category B. T4 TP1 F-E, S-D

Category B. T4 TP1 F-E, S-D

**TSFS 2015:66  
Bilaga 1**

UN No. (1)	PSN (2)	Class or Div (5)	Subsidiary Risk(s) (4)	Packing Group (3)	Special Provisions (6)	Limited quantities (7a)	Excepted quantities (7b)	Packing		IBC	
								Instruc-tions (8)	Provisions (9)	Instruc-tions (10)	Provisions (11)
3.1.2		2.0	2.0	2.0, 1.3	3.3	3.4	3.5	4.1, 4	4.1, 4	4.1, 4	

Portable tanks and bulk containers		EMs (15)	Stowage and Segregation (16)	Properties and Observations (17)
Tank instructions (15)	Provisions (14)			
4.2.5 4.3	4.2.5	54.5.2 7.8	7.1 to 7.7	

2351	BUTYLNITRITES	3	-	II	-	1 ℓ	E2	P001	-	IBC02	-	T4	TP1	F-E, S-D	Category B. Clear of living quarters.	Yellowish, volatile, only liquids; Partially miscible with water. Decompose into nitric acid, water or heat, evolving toxic nitrous fumes. Harmful by inhalation.	2351
2351	BUTYLNITRITES	3	-	III	223	5 ℓ	E1	P001 LPO1	-	IBC03	-	T2	TP1	F-E, S-D	Category A. Clear of living quarters.	See entry above.	2351
2352	BUTYL VINYL ETHER, STABILIZED	3	-	II	-	1 ℓ	E2	P001	-	IBC02	-	T4	TP1	F-E, S-D	Category B. Clear of living quarters.	Colourless, volatile liquid with a sharp ethereal odour. Flashpoint: -9°C c.c. Immiscible with water. Harmful by inhalation. Irritating to skin, eyes and mucous membranes.	2352
2353	BUTYRYL CHLORIDE	3	8	II	-	1 ℓ	E2	P001	-	IBC02	820	T8	TP2 TP13	F-E, S-C	Category C. Clear of living quarters.	Colourless liquid with a pungent odour. Reacts with water, evolving hydrogen chloride, an irritating and corrosive gas apparent as white fumes. In the presence of moisture, highly corrosive to most metals. Causes burns to skin, eyes and mucous membranes.	2353
2354	CHLOROMETHYL ETHYL ETHER	3	6.1	II	-	1 ℓ	E2	P001	-	IBC02	-	T7	TP1 TP13	F-E, S-D	Category E. Clear of living quarters.	Colourless liquid with a pungent odour. Partially miscible with water. Fumes in air, evolving hydrogen chloride, which is an irritating and corrosive gas. Toxic by inhalation. Strong lachrymator.	2354
2356	2-CHLOROPROPANE	3	-	I	-	0	E3	P001	-	-	-	T11	TP2 TP13	F-E, S-D	Category E.	Colourless liquid. Flashpoint: -32°C c.c. Explosive limits: 2.8% to 10.7%. Boiling point: 35°C. Immiscible with water. On contact with heat or flame, emits highly toxic phosgene gas. Can react vigorously with oxidizing materials.	2356
2357	CYCLOHEXYLAMINE	8	3	II	-	1 ℓ	E2	P001	-	IBC02	-	T7	TP2	F-E, S-C	Category A. Clear of living quarters.	Colourless or yellowish flammable liquid with a fishy odour. Flashpoint: 27°C c.c. Explosive limits: 0.5% to 21.7%. Miscible with water. Harmful by inhalation. Causes burns to skin and eyes. Irritating to mucous membranes.	2357
2358	CYCLOOCTATETRAENE	3	-	II	-	1 ℓ	E2	P001	-	IBC02	-	T4	TP1	F-E, S-D	Category B.	Colourless liquid. Freezing point: -4°C. Immiscible with water.	2358
2359	DIALLYLAMINE	3	6.1/8	II	-	1 ℓ	E2	P001	-	IBC99	-	T7	TP1	F-E, S-C	Category B. Clear of living quarters. Segregation as for class 3 but "Away from" class 4.1.	Colourless, volatile liquid with a disagreeable odour. Flashpoint: 7°C c.c. Partially miscible with water. Toxic if swallowed, by skin contact or by inhalation. Causes burns to skin, eyes and mucous membranes.	2359
2360	DIALLYL ETHER	3	6.1	II	-	1 ℓ	E2	P001	-	IBC02	-	T7	TP1 TP13	F-E, S-D	Category E.	Colourless, volatile liquid with a perceptible odour. Flashpoint: -11°C c.c. Immiscible with water. Toxic if swallowed, by skin contact or by inhalation.	2360
2361	DIISOBUTYLAMINE	3	8	III	-	5 ℓ	E1	P001	-	IBC03	-	T4	TP1	F-E, S-C	Category A.	Colourless liquid with a fishy odour. Flashpoint: 29°C c.c. Immiscible with water. Harmful by inhalation. Causes burns to skin and eyes. Irritating to mucous membranes.	2361
2362	1,1-DICHLOROETHANE	3	-	II	-	1 ℓ	E2	P001	-	IBC02	-	T4	TP1	F-E, S-D	Category B. Clear of living quarters.	Colourless liquid with an aromatic, ethereal odour. Flashpoint: -10°C c.c. Explosive limits: 5.6% to ... Immiscible with water. When involved in a fire, emits toxic fumes of phosgene. Harmful by inhalation.	2362
2363	ETHYL MERCAPTAN	3	-	I	-	0	E3	P001	-	-	-	T11	TP2 TP13	F-E, S-D	Category E. Segregation from class 2, 3 or 7.3. Separated from absorbing cargoes.	Volatile liquid with a strong unpleasant odour. Flashpoint: -45°C c.c. Explosive limits: 2.8% to 18.2%. Boiling point: 35°C. Immiscible with water.	2363
2364	n-PROPYLBENZENE	3	-	III	-	5 ℓ	E1	P001 LPO1	-	IBC03	-	T2	TP1	F-E, S-D	Category A.	Colourless liquid. Flashpoint: 39°C c.c. Explosive limits: 0.8% to 6%. Immiscible with water.	2364
2366	DIETHYL CARBONATE	3	-	III	-	5 ℓ	E1	P001 LPO1	-	IBC03	-	T2	TP1	F-E, S-D	Category A.	Colourless liquid. Flashpoint: 25°C to 31°C c.c. Vapour much heavier than air (1.3). Miscible with water. Irritating to skin, eyes and mucous membranes.	2366
2367	alpha-METHYLVALERALDEHYDE	3	-	II	-	1 ℓ	E2	P001	-	IBC02	-	T4	TP1	F-E, S-D	Category B.	Colourless liquid. Flashpoint: 13°C c.c. Immiscible with water. Irritating to skin, eyes and mucous membranes.	2367



UN No. (1)	PSN (2)	Class No. (3)	Subsidiary Risk(s) (4)	Packing Group (5)	Special Provisions (6)	Limited quantities (7a)	Excepted quantities (7b)	Packing			IBC			UN No. (16)	Properties and Observations (17)		
								Class or Div. No. (5)	Packing (5)	Instruct-ions (6)	Provisions (9)	Instruc-tions (10)	Provisions (11)			Tank instructions (15)	Provisions (14)
	3.1.2	2.0	2.0	2.0, 1.3	3.3	3.4	3.5	4.1, 4	4.1, 4	4.1, 4	4.1, 4	4.3	4.2, 5	5.4, 5.2	7.1 to 7.7		
2368	alpha-PINENE	3	-	III	-	5 ℓ	E1	P001	-	IBC03	-	T2	TP1	F-E, S-E	Category A.	Colourless liquid with an odour of turpentine. Flashpoint: 33°C c.c. Harmful by inhalation. Irritating to skin, eyes and mucous membranes.	2368
2370	1-HEXENE	3	-	II	-	1 ℓ	E2	P001	-	IBC02	-	T4	TP1	F-E, S-D	Category E.	Colourless liquid. Explosive limits: 1.2% to 6.9%. Immiscible with water.	2370
2371	ISOPENTENES	3	-	I	-	0	E3	P001	-	-	-	T1.1	TP2	F-E, S-D	Category E.	Colourless, volatile liquid with a disagreeable odour. Flashpoint: below -18°C c.c. Immiscible with water. Irritating to skin, eyes and mucous membranes.	2371
2372	1,2-DI-METHYLAMINOETHANE	3	-	II	-	1 ℓ	E2	P001	-	IBC02	-	T4	TP1	F-E, S-D	Category B.	Colourless liquid. Flashpoint: 21°C c.c. Miscible with water. Irritability to skin, eyes and mucous membranes.	2372
2373	DIETHOXYMETHANE	3	-	II	-	1 ℓ	E2	P001	-	IBC02	-	T4	TP1	F-E, S-D	Category B.	Colourless liquid. Flashpoint: below -5°C c.c. Miscible with water.	2373
2374	3,3-DIETHOXYPROPENE	3	-	II	-	1 ℓ	E2	P001	-	IBC02	-	T4	TP1	F-E, S-D	Category B.	Colourless liquid. Flashpoint: 15°C c.c. Partially miscible with water. Harmful by inhalation.	2374
2375	DIETHYL SULPHIDE	3	-	II	-	1 ℓ	E2	P001	-	IBC02	-	T7	TP1 TP13	F-E, S-D	Category E.	Colourless, volatile liquid with an odour of garlic. Flashpoint: -10°C c.c. Immiscible with water.	2375
2376	2,3-DIHYDROPYRAN	3	-	II	-	1 ℓ	E2	P001	-	IBC02	-	T4	TP1	F-E, S-D	Category B.	Colourless, volatile liquid with an ethereal odour. Flashpoint: -16°C c.c. Miscible with water.	2376
2377	1,1-DIMETHOXYETHANE	3	-	II	-	1 ℓ	E2	P001	-	IBC02	-	T7	TP1	F-E, S-D	Category B.	Colourless liquid with a strong aromatic odour. Miscible with water.	2377
2378	2-DIMETHYLAMINOACETONITRILE	3	6.1	II	-	1 ℓ	E2	P001	-	IBC02	-	T7	TP1	F-E, S-D	Category A. Clear of living quarters. Separated from acids.	Colourless liquid. Flashpoint: 35°C c.c. Immiscible with water. On contact with acids evolves toxic fumes. Toxic if swallowed, by skin contact or by inhalation.	2378
2379	1,3-DIMETHYLBUTYLAMINE	3	8	II	-	1 ℓ	E2	P001	-	IBC02	-	T7	TP1	F-E, S-C	Category B. "Separated from" acids.	Colourless liquid with an ammonia-like odour. Flashpoint: 9°C to 13°C c.c. Immiscible with water. Reacts violently with acids. Harmful by inhalation. Causes burns to skin and eyes. Irritating to mucous membranes.	2379
2380	DIMETHYLDIETHOXYLSILANE	3	-	II	-	1 ℓ	E2	P001	-	IBC02	-	T4	TP1	F-E, S-D	Category B.	Colourless liquid. Flashpoint: 13°C c.c. Miscible with water. Irritating to skin, eyes and mucous membranes.	2380
2381	DIMETHYL DISULPHIDE	3	6.1	II	-	1 ℓ	E2	P001	-	IBC02	-	T7	TP2, TP13 TP39	F-E, S-D	Category B. Clear of living quarters.	Yellow liquid with an unpleasant odour. Flashpoint: 15°C c.c. Immiscible with water. When involved in a fire, evolves toxic gases. Toxic if swallowed, by skin contact or by inhalation.	2381
2382	DIMETHYLDIAZINE, SYMMETRICAL	6.1	3	I	35.4	0	E0	P602	-	-	-	T20 TP3 TP37	TP2 TP3	F-E, S-D	Category D. Clear of living quarters. "Separated from" class 5.1. "Separated from" acids.	Colourless, flammable, volatile liquid with an ammonia-like odour. Miscible with water. Reacts violently with acids. May react dangerously with oxidizing substances. Flashpoint: -17°C c.c. Highly toxic if swallowed, by skin contact or by inhalation.	2382
2383	DIPROPYLAMINE	3	8	II	-	1 ℓ	E2	P001	-	IBC02	-	T7	TP1	F-E, S-C	Category B.	Colourless liquid with a fishy odour. Flashpoint: 7°C c.c. Immiscible with water. Harmful by inhalation. Causes burns to skin, eyes and mucous membranes.	2383
2384	Di-n-PROPYL ETHER	3	-	II	-	1 ℓ	E2	P001	-	IBC02	-	T4	TP1	F-E, S-D	Category B.	Colourless liquid. Flashpoint (pure product): -21°C c.c. Explosive limits: 1.7% to ... Immiscible with water.	2384

UN No. (1)	PSN (2)	Class No. (3)	Subsidiary Risk(s) (4)	Packing Group (5)	Special Provisions (6)	Limited quantities (7a)	Excepted quantities (7b)	Packing		IBC	
								Instructions (8)	Provisions (9)	Instructions (10)	Provisions (11)
3	3.1.2	2.0	2.0	2.0, 1.3	3.3	3.4	3.5	4.1, 4	4.1, 4	4.1, 4	
2385	ETHYL ISOBUTYRATE	3	-	II	-	1 ℓ	E2	P001	-	IBC02	-
2386	1-ETHYLPYRIDINE	3	8	II	-	1 ℓ	E2	P001	-	IBC02	-
2387	FLUOROBENZENE	3	-	II	-	1 ℓ	E2	P001	-	IBC02	-
2388	FLUOROTOLUENS	3	-	II	-	1 ℓ	E2	P001	-	IBC02	-
2389	FURAN	3	-	I	-	0	E3	P001	-	-	-
2390	2-IODOBUTANE	3	-	II	-	1 ℓ	E2	P001	-	IBC02	-
2391	1,1-DIMETHYLPROPANES	3	-	II	-	1 ℓ	E2	P001	-	IBC02	-
2392	1-ODOPROPANES	3	-	III	-	5 ℓ	E1	P001 LP01	-	IBC03	-
2393	ISOBUTYL FORMATE	3	-	II	-	1 ℓ	E2	P001	-	IBC02	-
2394	ISOBUTYL PROPIONATE	3	-	III	-	5 ℓ	E1	P001 LP01	-	IBC03	-
2395	ISOBUTYRIL CHLORIDE	3	8	II	-	1 ℓ	E2	P001	-	IBC02	-
2396	METHACRYLALDEHYDE, STABILIZED	3	6.1	II	-	1 ℓ	E2	P001	-	IBC02	-
2397	3-METHYLBUTAN-2-ONE	3	-	II	-	1 ℓ	E2	P001	-	IBC02	-
2398	METHYL tert-BUTYL ETHER	3	-	II	-	1 ℓ	E2	P001	-	IBC02	-
2399	1-METHYLPYRIDINE	3	8	II	-	1 ℓ	E2	P001	-	IBC02	-
2400	METHYL ISOVALERATE	3	-	II	-	1 ℓ	E2	P001	-	IBC02	-

UN No. (16)	Properties and Observations (17)	Stowage and Segregation (16)	EMs (15)	Portable tanks and bulk containers	
				Tank instructions (15)	Provisions (14)
2385	Colourless, volatile liquid with an aromatic odour. Flashpoint: 21°C c.c. Immiscible with water.	7.1 to 7.7	5.4, 5.2 7.8	4.2, 5 4.3	TP1
2386	Colourless liquid. Flashpoint: 19°C c.c. Immiscible with water. Reacts violently with acids. Harmful by inhalation. Causes burns to skin, eyes and mucous membranes. May cause lung damage.	"Separated from" acids.	F-E, S-C	TP1	Category B.
2387	Colourless liquid with a benzene odour. Flashpoint: -15°C c.c. Immiscible with water. Harmful by inhalation.	Category B.	F-E, S-D	TP1	Category B.
2388	Colourless liquids. ortho-FLUOROTOLUENE: flashpoint 9°C c.c. meta-FLUOROTOLUENE: flashpoint 15°C c.c. para-FLUOROTOLUENE: flashpoint 19°C c.c. Immiscible with water.	Category B.	F-E, S-D	TP1	Category B.
2389	Colourless liquid with a strong odour. Flashpoint: below -18°C c.c. Explosive limits: 1.3% to 14.3%. Boiling point: 31°C. Immiscible with water. Harmful if swallowed, by skin contact or by inhalation.	Category E. Clear of living quarters.	F-E, S-D	TP2 TP13	Category E. Clear of living quarters.
2390	Colourless liquid. Flashpoint: 21°C c.c. Immiscible with water.	Category B.	F-E, S-D	TP1	Category B.
2391	Colourless liquids. Immiscible with water.	Category B.	F-E, S-D	TP1	Category B.
2392	Colourless liquids. 1-IODOPROPANE: flashpoint 34°C c.c. 2-IODOPROPANE: flashpoint approx. 25°C c.c. Immiscible with water.	Category A.	F-E, S-D	TP1	Category A.
2393	Colourless liquid. Flashpoint: 5°C c.c. Explosive limits: 1.7% to 8%. Irritating to skin, eyes and mucous membranes.	Category B.	F-E, S-D	TP1	Category B.
2394	Colourless liquid. Flashpoint: 31°C c.c. Immiscible with water.	Category B.	F-E, S-D	TP1	Category B.
2395	Colourless liquid with a pungent odour. Reacts with water, evolving hydrogen chloride gas. Highly corrosive gas, appears as white fumes. In the presence of moisture, highly corrosive to most metals. Causes burns to skin, eyes and mucous membranes.	Category C. Clear of living quarters.	F-E, S-C	TP2	Category C. Clear of living quarters.
2396	Colourless liquid. Flashpoint: 2°C c.c. Miscible with water. Toxic by inhalation. Irritating to skin, eyes and mucous membranes.	Category E. Clear of living quarters.	F-E, S-D	TP1 TP13	Category E. Clear of living quarters.
2397	Colourless liquid. Flashpoint: -3°C c.c. Explosive limits: 1.5% to 8%. Immiscible with water.	Category B.	F-E, S-D	TP1	Category B.
2398	Colourless liquid. Flashpoint: below 18°C c.c. Explosive limits: 1.7% to 8.4%. Boiling point: 55°C. Immiscible with water.	Category E.	F-E, S-D	TP1	Category E.
2399	Colourless liquid. Flashpoint: 3°C c.c. Miscible with water. Reacts violently with acids. Harmful by inhalation. Causes burns to skin, eyes and mucous membranes.	Category B. "Separated from" acids.	F-E, S-C	TP1	Category B. "Separated from" acids.
2400	Colourless liquid. Immiscible with water.	Category B.	F-E, S-D	TP1	Category B.

UN No. (1)	PSN (2)	Class or Div (5)	Subsidiary Risk(s) (4)	Packing Group (3)	Special Provisions (6)	Limited quantities (7a)	Excepted quantities (7b)	Packing			IBC			
								Instruc-tions (8)	Instruc-tions (9)	Instruc-tions (10)	Instruc-tions (11)	Provisions (12)	Provisions (13)	Provisions (14)
3.1.2		2.0	2.0	2.0, 1.3	3.3	3.4	3.5	4.1, 4	4.1, 4	4.1, 4				

UN No. (15)	Provisi- ons (16)	EMs (17)	Stowage and Segregation (18)	Properties and Observations (19)	UN No. (16)
4.2.5 4.3	4.2.5	54.5.2 7.8			

2401	PIPERIDINE	8	3	I	-	0	E0	P001	-	-	T10	TP2	F-E, S-C	Category D. "Separated from" acids. Colourless liquid with a fish-like odour. Miscible with water. Reacts with acids to form salts. Strongly alkaline and is corrosive. When involved in fire evolves toxic nitrous fumes.	2401
2402	PROPANETHIOLS	3	-	II	-	1 ℓ	E2	P001	-	IBC02	T4	TP1 TP13	F-E, S-D	Category E. Segregation from foodstuffs as in 7.3.4.2, 7.6.3.1.2. Colourless or yellowish liquids with a strong unpleasant odour. Flashpoint: below-18°C c.c. Boiling range: 53°C to 67°C. Immiscible with water.	2402
2403	ISOPROPENYLACETATE	3	-	II	-	1 ℓ	E2	P001	-	IBC02	T4	TP1	F-E, S-D	Category B. Colourless liquid. Flashpoint: 10°C c.c. Immiscible with water.	2403
2404	PROPIONITRILE	3	6.1	II	-	1 ℓ	E2	P001	-	IBC02	T7 TP13	TP1 TP13	F-E, S-D	Category E. Clear of living quarters. Colourless, volatile liquid with an ether-like odour. Flashpoint: 2°C c.c. Explosive limits: 3.1% to ... Miscible with water. When involved in a fire, evolves highly toxic cyanide fumes. Toxic if swallowed, by skin contact or by inhalation.	2404
2405	ISOPROPYL BUTYRATE	3	-	III	-	5 ℓ	E1	P001 LP01	-	IBC03	T2	TP1	F-E, S-D	Category A. Colourless liquid. Flashpoint: 25°C c.c. Immiscible with water. Irritating to skin, eyes and mucous membranes.	2405
2406	ISOPROPYL ISOBUTYRATE	3	-	II	-	1 ℓ	E2	P001	-	IBC02	T4	TP1	F-E, S-D	Category B. Colourless liquid. Flashpoint: 20°C c.c. Immiscible with water. Narcotic. Irritating to skin, eyes and mucous membranes.	2406
2407	ISOPROPYL CHLOROFORMATE	6.1	3.8	I	354	0	E0	P602	-	-	-	-	F-E, S-C	Category D. Clear of living quarters. Segregation as for class 3 but "Away from" class 4.1. Colourless flammable liquid. Flashpoint: 16°C c.c. Decomposed by water, giving hydrogen chloride, an irritating and corrosive gas apparent as white fumes. Toxic if swallowed, by skin contact or by inhalation. Causes burns to skin, eyes and mucous membranes.	2407
2409	ISOPROPYL PROPIONATE	3	-	II	-	1 ℓ	E2	P001	-	IBC02	T4	TP1	F-E, S-D	Category B. Colourless liquid. Flashpoint: 21°C c.c. Immiscible with water.	2409
2410	1,2,3,6-TETRAHYDROPIRIDINE	3	-	II	-	1 ℓ	E2	P001	-	IBC02	T4	TP1	F-E, S-D	Category B. Colourless liquid. Flashpoint: 16°C c.c. Miscible with water. Harmful by inhalation.	2410
2411	BUTYRONITRILE	3	6.1	II	-	1 ℓ	E2	P001	-	IBC02	T7 TP13	TP1 TP13	F-E, S-D	Category E. Clear of living quarters. Colourless liquid. Flashpoint: 21°C c.c. Explosive limits: 1.6% to ... Immiscible with water. Toxic if swallowed, by skin contact or by inhalation.	2411
2412	TETRAHYDROTHIOPHENE	3	-	II	-	1 ℓ	E2	P001	-	IBC02	T4	TP1	F-E, S-D	Category B. Colourless liquid with a pleasant odour. Flashpoint: 13°C c.c. Immiscible with water.	2412
2413	TETRAPROPYL ORTHOBTANATE	3	-	III	-	5 ℓ	E1	P001 LP01	-	IBC03	T4	TP1	F-E, S-D	Category A. Colourless liquid. Flashpoint: 38°C c.c.	2413
2414	THIOPHENE	3	-	II	-	1 ℓ	E2	P001	-	IBC02	T4	TP1	F-E, S-D	Category B. Clear of living quarters. Colourless liquid with an unpleasant odour. Flashpoint: -9°C c.c. Explosive limits: 1.5% to 12.5%. Immiscible with water. Irritating to skin, eyes and mucous membranes.	2414
2416	TRIMETHYL BORATE	3	-	II	-	1 ℓ	E2	P001	-	IBC02	T7	TP1	F-E, S-D	Category B. Colourless liquid. Reacts with water, evolving flammable vapours.	2416
2417	CARBONYL FLUORIDE	2.3	8	-	-	0	E0	P200	-	-	-	-	F-C, S-U	Category D. Clear of living quarters. Non-flammable, toxic and corrosive colourless gas with a pungent odour. Corrosive to glass and to most metals. Corrosive in the presence of water. Much heavier than air (3.3). Highly irritating to skin, eyes and mucous membranes.	2417
2418	SULPHUR TETRAFLUORIDE	2.3	8	-	-	0	E0	P200	-	-	-	-	F-C, S-U	Category D. Clear of living quarters. "Separated from" acids. Non-flammable, toxic and corrosive, colourless gas with a pungent odour. Reacts with water, moist air or acids to produce toxic and corrosive hydrogen fluoride. Heavier than air (3.7). Highly irritating to skin, eyes and mucous membranes.	2418

**TSFS 2015:66**  
**Bilaga 1**

UN No. (1)	PSN (2)	Packaging				IBC		Portable tanks and bulk containers		Properties and Observations (17)	UN No. (18)		
		Class or Div (5)	Subsidiary Risk(s) (4)	Packing Group (3)	Special Provisions (6)	Limited quantities (7a)	Excepted quantities (7b)	Instructi- ons (8)	Provisions (9)			Instruc- tions (15)	Provisions (14)
3.1.2		2.0	2.0	2.0,1,3	3.3	3.4	3.5	4.1,4	4.1,4	4.1,4	4.2,5 4.3	7.1 to 7.7	

2419 BROMOTRIFLUOROETHYLENE 2.1 - - - - 0 ED P200 - - - - F-D, S-U Category B. Clear of living quarters. Liquefied, flammable, colourless gas. Much heavier than air (5.6). Boiling point: -3°C. 2419

2420 HEXAFLUOROACETONE 2.3 8 - - - 0 ED P200 - - - - F-C, S-U Category D. Clear of living quarters. Non-flammable, toxic and corrosive, colourless, hygroscopic gas with an unpleasant odour. Reacts vigorously with water, evolving heat. Corrosive to glass and to most metals. Fumes in moist air. Much heavier than air (5.7). Highly irritating to skin, eyes and mucous membranes. 2420

2421 NITROGEN TRIOXIDE 2.3 5.1/8 - - - 0 ED P200 - - - - F-C, S-W Category D. Clear of living quarters. Liquefied, non-flammable, toxic and corrosive gas. At lower temperatures, (3.7), highly irritating to skin, eyes and mucous membranes. (2.6). Boiling point: 3.5°C. Highly irritating to skin, eyes and mucous membranes. 2421

2422 OCTAFLUOROBUT-2-ENE (REFRIGERANT GAS R 1318) 2.2 - - - - 120 ml<sup>f</sup> EI P200 - - - - F-C, S-V Category A. Liquefied, non-flammable, colourless gas. Much heavier than air (6.9). Boiling point: 1,2°C. 2422

2424 OCTAFLUOROPROPANE (REFRIGERANT GAS R 218) 2.2 - - - - 120 ml<sup>f</sup> EI P200 - - - - F-C, S-V Category A. Liquefied, non-flammable, colourless gas. Much heavier than air (6.6). Boiling point: -36°C. 2424

2426 AMMONIUM NITRATE, LIQUID (hot concentrated solution) 5.1 - - - 252 942 0 ED - - - - T7 TP1 TP6 TP7 Category D. "Separated from" combustible material, bromates, chlorates, chlorites, hypochlorites, nitrites, perchlorates, peroxides, peroxo-compounds and powdered metals. Hot aqueous solution of not more than 93% ammonium nitrate with not more than 0.2% combustible material (including organic material calculated as carbon) and free from any other added matter, containing at least 7% water, while the maximum content of chloride ions should not exceed 0.2%. The solution should be free from free chlorine and other material (e.g. wood, straw, cotton, oil, sugar, etc.), strong acids, and other class 5.1 substances and burn fiercely. Maximum allowable transport temperature of the solution 140°C. This temperature should be indicated on the container. The container should be completely filled. The inner parts (water to one part of dry mass) should be between 5.0 and 7.0. The concentration and temperature of the solution at the time of loading, its percentage of combustible materials and of chlorides, and the contents of free acid should be certified. 2426

2427 POTASSIUM CHLORATE, AQUEOUS SOLUTION 5.1 - II - - 1 ℓ - - - - T4 TP1 F-H, S-Q Category B. "Separated from" ammonium compounds, cyanides and sulphur. Colourless liquid. When involved in a fire, may cause an explosion. Leakage and subsequent evaporation of the water may present increased danger of explosion. 1. - in contact with combustible material (particularly with fibrous material such as jute, cotton or sisal) or sulphur, danger of spontaneous combustion; 2. - in contact with ammonium compounds, powdered metals or oils, danger of explosion. See entry above. 2427

2428 SODIUM CHLORATE, AQUEOUS SOLUTION 5.1 - III 223 5 ℓ EI P504 - - - - T4 TP1 F-H, S-Q Category B. "Separated from" ammonium compounds, cyanides and sulphur. Colourless liquid. When involved in a fire, may cause an explosion. Leakage and subsequent evaporation of the water may present increased danger as follows: 1. - in contact with combustible material (particularly with fibrous material such as jute, cotton or sisal) or sulphur, danger of spontaneous combustion; 2. - in contact with ammonium compounds, powdered metals or oils, danger of explosion. See entry above. 2428

2429 CALCIUM CHLORATE, AQUEOUS SOLUTION 5.1 - II - - 1 ℓ - - - - T4 TP1 F-H, S-Q Category B. "Separated from" ammonium compounds, cyanides and sulphur. Colourless liquid. When involved in a fire, may cause an explosion. Leakage and subsequent evaporation of the water may present increased danger as follows: 1. - in contact with combustible material (particularly with fibrous material such as jute, cotton or sisal) or sulphur, danger of spontaneous combustion; 2. - in contact with ammonium compounds, powdered metals or oils, danger of explosion. See entry above. 2429

2429 CALCIUM CHLORATE, AQUEOUS SOLUTION 5.1 - III 223 5 ℓ EI P504 - - - - T4 TP1 F-H, S-Q Category B. "Separated from" ammonium compounds, cyanides and sulphur. Colourless liquid. When involved in a fire, may cause an explosion. Leakage and subsequent evaporation of the water may present increased danger as follows: 1. - in contact with combustible material (particularly with fibrous material such as jute, cotton or sisal) or sulphur, danger of spontaneous combustion; 2. - in contact with ammonium compounds, powdered metals or oils, danger of explosion. See entry above. 2429

UN No. (1)	PSN (2)	Class or Div. (3)	Subsidiary Risk(s) (4)	Packing Group (5)	Special Provisions (6)	Limited quantities (7a)	Excepted quantities (7b)	Packing		IBC		Portable tanks and bulk containers			Properties and Observations (17)	UN No. (18)	
								Instruc-tions (8)	Provisions (9)	Instruc-tions (10)	Provisions (11)	Tank instructions (12)	Provisions (13)	EMs (15)			Stowage and Segregation (16)
2430	ALKYLPHENOLS, SOLID, N.O.S. (including C2-C12 homologues)	8	-	I	-	0	E0	P002	-	IBC07	B1	T6	TP33	F-A, S-B	Category B.	A wide range of colours; to pale straw-coloured solids with penetrating odour. Insoluble in water. Causes burns to skin, eyes and mucous membranes.	2430
2430	ALKYLPHENOLS, SOLID, N.O.S. (including C2-C12 homologues)	8	-	II	-	1 kg	E2	P002	-	IBC08	B2 B4	T3	TP33	F-A, S-B	Category B.	See entry above.	2430
2430	ALKYLPHENOLS, SOLID, N.O.S. (including C2-C12 homologues)	8	-	III	223	5 kg	E1	P002 LP02	-	IBC08	B3	T1	TP33	F-A, S-B	Category A.	See entry above.	2430
2431	ortho-ANISIDINES	6.1	-	III	-	5 l	E1	P001 LP01	-	IBC03	-	T4	TP1	F-A, S-A	Category A.	Reddish or yellowish oily liquid. Immiscible with water. Toxic if swallowed, by skin contact or by inhalation.	2431
2432	N,N-DIETHYLANILINE	6.1	-	III	279	5 l	E1	P001 LP01	-	IBC03	-	T4	TP1	F-A, S-A	Category A.	Colourless to yellow-brown oily liquid. Combustible. Toxic if swallowed, by skin contact or by inhalation.	2432
2433	CHLORONITROLUENIS, LIQUID	6.1	-	III	-	5 l	E1	P001 LP01	-	IBC03	-	T4	TP1	F-A, S-A	Category A. Segregation as for class 5.1. But, Away from classes 4.1, 5.1 and 7.	Immiscible with water. Oxidizing substance which may explode or burn freely when in contact with organic materials. Toxic if swallowed, by skin contact or by inhalation.	2433
2434	DIBENZIDICHLOROSILANE	8	-	II	-	0	E0	P010	-	-	-	T10	TP2 TP3	F-A, S-B	Category C. Clear of living quarters.	Colourless liquid with a pungent odour. Reacts violently with water, evolves hydrogen chloride, a corrosive gas. When involved in a fire, evolves toxic gases. In the presence of moisture, highly corrosive to most metals. Vapour irritating to skin, eyes and mucous membranes.	2434
2435	ETHYLPHENYLDICHLOROSILANE	8	-	II	-	0	E0	P010	-	-	-	T10	TP2 TP3	F-A, S-B	Category C.	Colourless liquid with a pungent odour. Reacts with water, evolving hydrogen chloride, a corrosive gas as apparent as white fumes. When involved in a fire, evolves toxic gases. In the presence of moisture, highly corrosive to most metals. Causes burns to skin, eyes and mucous membranes.	2435
2436	THIOACETIC ACID	3	-	II	-	1 l	E2	P001	-	IBC02	-	T4	TP1	F-E, S-D	Category B.	Colourless or yellow liquid with a pungent odour. Miscible with water. Harmful by inhalation.	2436
2437	METHYLPHENYLDICHLOROSILANE	8	-	II	-	0	E0	P010	-	-	-	T10	TP2 TP3	F-A, S-B	Category C. Clear of living quarters.	Colourless liquid. Reacts with water, evolving hydrogen chloride, an irritating and corrosive gas as apparent as white fumes. When involved in a fire, evolves toxic gases. In the presence of moisture, highly corrosive to most metals. Causes burns to skin, eyes and mucous membranes.	2437
2438	TRIMETHYLACETYL CHLORIDE	6.1	3/8	I	-	0	E5	P001	-	-	-	T14	TP2 TP3	F-E, S-C	Category D. Protected from sources of heat. Clear of living quarters. Segregation as for class 3 but "Away from" class 4.1.	Flammable liquid. Flashpoint: 19°C c.c. Boiling point: 108°C. Reacts with water, evolving hydrogen chloride, a corrosive gas as apparent as white fumes. In the presence of moisture, corrosive to most metals. Highly toxic if swallowed, by skin contact or by inhalation. Causes burns to skin, eyes and mucous membranes.	2438
2439	SODIUM HYDROGENFLUORIDE	8	-	II	-	1 kg	E2	P002	-	IBC08	B2 B4	T3	TP33	F-A, S-B	Category A. Keep as cool as possible. Clear of sources of heat. Clear of living quarters. "Separated from" acids.	White, crystalline powder. Soluble in water. Decomposed by heat or acids, evolving hydrogen fluoride gas. In the presence of moisture, highly corrosive to glass, other siliceous materials and most metals. Causes burns to skin, eyes and mucous membranes.	2439
2440	STANNIC CHLORIDE PENTAHYDRATE	8	-	III	-	5 kg	E1	P002 LP02	-	IBC08	B3	T1	TP33	F-A, S-B	Category A.	White, deliquescent solid. Melting point: about 60°C. Soluble in water. In the presence of water, corrosive to most metals. Irritating to skin, eyes and mucous membranes.	2440
2441	TITANIUM TRICHLORIDE, PYROPHORIC or TITANIUM TRICHLORIDE MIXTURE, PYROPHORIC	4.2	8	I	-	0	E0	P404	-	-	-	-	-	F-G, S-M	Category D. Clear of living quarters.	Finely divided, violet, crystalline solid. May ignite on exposure to air or moisture. In the presence of moisture, corrosive to most metals. Causes burns to skin, eyes and mucous membranes.	2441
2442	TRICHLOROACETYL CHLORIDE	8	-	II	-	0	E2	P001	-	-	-	T7	TP2	F-A, S-B	Category D. Clear of living quarters.	Liquid with a pungent odour, which fumes in moist air. Reacts violently with water, evolving hydrogen chloride, a corrosive gas as apparent as white fumes. When involved in a fire, evolves toxic gases. In the presence of moisture, corrosive to most metals. Liquid and vapours cause burns to skin, eyes and mucous membranes.	2442

**TSFS 2015:66**  
**Bilaga 1**

UN No. (1)	PSN (2)	Class or Div (3)	Subsidiary Risk(s) (4)	Packing Group (5)	Special Provisions (6)	Limited quantities (7a)	Excepted quantities (7b)	Packing		IBC		Tank instructions (15)	Provisions (14)	EMS (15)	Stowage and Segregation (16)	Properties and Observations (17)	UN No. (18)	
								Instruc-tions (8)	Provisions (9)	Instruc-tions (10)	Provisions (11)							
	3.1.2	2.0	2.0	2.0, 1.3	3.3	3.4	3.5	4.1, 4	4.1, 4	4.1, 4	4.3	4.2, 5	4.2, 5	5.4, 5.2	7.1 to 7.7			
2443	VANADIUM OXYTRICHLORIDE	8	-	II	-	1 ℓ	E2	P001	-	IBC02	-	T7	TP2	F-A, S-B	Category C. Clear of living quarters.	Yellow liquid. Decomposition occurs on exposure to moist air, forming as white fumes. Reacts with, or dissolves, many organic compounds in the presence of moisture, corrosive to most metals. Causes burns to skin, eyes and mucous membranes.	2443	
2444	VANADIUM TETRACHLORIDE	8	-	I	-	0	E0	P802	-	-	-	T10	TP2	F-A, S-B	Category C. Clear of living quarters.	Reddish-brown liquid. Decomposes under the influence of light, evolving chlorine, a highly toxic and irritating gas. Reacts violently with water, evolving hydrogen chloride, a corrosive gas, apparent as white fumes. In cause burns to skin, eyes and mucous membranes. Liquid and vapour cause burns to skin, eyes and mucous membranes.	2444	
2446	NITROCESOLS, SOLID	6.1	-	III	-	5 kg	E1	P002 LP02	-	IBC08	B3	T1	TP3	F-A, S-A	Category A.	Yellow crystals. Melting point: 32°C or above. Slightly soluble in water. Toxic if swallowed, by skin contact or by inhalation.	2446	
2447	PHOSPHORUS, WHITE, MOLTEN	4.2	6.1 P	I	-	0	E0	-	-	-	-	T21	TP3 TP7 TP26	E-A, S-M	Category D.	Molten liquid. Melting point: 44°C. Ignites spontaneously in air. Toxic if swallowed, by skin contact or by inhalation. Shipped molten above its melting point.	2447	
2448	SULPHUR, MOLTEN	4.1	-	III	-	0	E0	-	-	IBC01	-	T1	TP3	F-A, S-H	Category C. "Separated from" class 5.1.	Melting point: 119°C. Molten sulphur may contain hydrogen sulphide which is highly poisonous in low concentrations. When involved in a fire, evolves toxic, very irritating and sulfidating gas. Forms explosive and highly corrosive fumes with oxidizing substances. Shipped molten above its melting point.	2448	
2451	NITROGEN TRIFLUORIDE	2.2	5.1	-	-	0	E0	P200	-	-	-	-	-	F-C, S-W	Category D. Clear of living quarters.	Non-flammable, non-toxic, colourless, odourless gas. Strong oxidizing agent; reacts violently with many substances, e.g. grease, oil, etc. Much heavier than air (2.4). May cause slight eye irritation.	2451	
2452	ETHYLACETYLENE, STABILIZED	2.1	-	-	-	0	E0	P200	-	-	-	-	-	F-D, S-U	Category B. Clear of living quarters.	Liquefied, flammable, colourless gas with an odour similar to acetylene. Heavier than air (1.9). Boiling point: 8°C. Irritating to skin, eyes and mucous membranes.	2452	
2453	ETHYL FLUORIDE (REFRIGERANT GAS R 161)	2.1	-	-	-	0	E0	P200	-	-	-	-	-	F-D, S-U	Category E. Clear of living quarters.	Liquefied, flammable, colourless gas. Explosive limits: 5% to 10%. Heavier than air (1.7). Boiling point: -37°C.	2453	
2454	METHYL FLUORIDE (REFRIGERANT GAS R 41)	2.1	-	-	-	0	E0	P200	-	-	-	-	-	F-D, S-U	Category E. Clear of living quarters.	Flammable, colourless gas. Heavier than air (1.2).	2454	
2455	METHYLNITRILE	2.2	-	-	-	900	-	-	-	-	-	-	-	-	-	Transport is prohibited.		2455
2456	2-CHLOROPROPENE	3	-	I	-	0	E3	P001	-	-	-	T11	TP2	F-E, S-D	Category E.	Colourless liquid. Flashpoint: below -18°C c.c. Explosive limits: 2.5% to 7.2%. Boiling point: 25°C. Immiscible with water. Harmful if swallowed or by inhalation. Irritating to skin, eyes and mucous membranes.	2456	
2457	2,3-DIMETHYLBUTANE	3	-	II	-	1 ℓ	E2	P001	-	IBC02	-	T7	TP1	F-E, S-D	Category E.	Colourless liquid. Flashpoint: -29°C c.c. Explosive limits: 1.26 to 7%. Immiscible with water. Irritating to skin, eyes and mucous membranes. Narcotic in high concentrations.	2457	
2458	HEXADIENES	3	-	II	-	1 ℓ	E2	P001	-	IBC02	-	T4	TP1	F-E, S-D	Category B.	Colourless liquids. Flashpoint: -31°C c.c. Immiscible with water. Irritating to skin, eyes and mucous membranes. 1,4-HEXADIENE: flashpoint -25°C c.c. 1,5-HEXADIENE: flashpoint -27°C c.c. 2,4-HEXADIENE: flashpoint -7°C c.c. Immiscible with water. Harmful by inhalation. Irritating to skin, eyes and mucous membranes.	2458	
2459	2-METHYL-1-BUTENE	3	-	I	-	0	E3	P001	-	-	-	T11	TP2	F-E, S-D	Category E.	Colourless, volatile liquid with a disagreeable odour. Flashpoint: below -18°C c.c. Immiscible with water. Irritating to skin, eyes and mucous membranes.	2459	
2460	2-METHYL-2-BUTENE	3	-	II	-	1 ℓ	E2	P001	-	IBC02	B8	T7	TP1	F-E, S-D	Category E.	Colourless, volatile liquid with a disagreeable odour. Flashpoint: below -18°C c.c. Immiscible with water. Irritating to skin, eyes and mucous membranes.	2460	

UN No. (1)	PSN (2)	Class No. (3)	Subsidiary Risk(s) (4)	Packing Group (5)	Special Provisions (6)	Limited quantities (7a)	Excepted quantities (7b)	Packing		IBC		Portable tanks and bulk containers		EMS (15)	Stowage and Segregation (16)	Properties and Observations (17)	UN No. (18)
								Instruc-tions (8)	Provisions (9)	Instruc-tions (10)	Provisions (11)	Tank instructions (12)	Provisions (13)				
2461	METHYLPENTADIENE	3	-	II	-	1 l	E2	P001	-	IBC02	-	T4	TP1	F-E, S-D	Category E	Colourless liquids. Flashpoint: below-18°C c.c. Immiscible with water. Irritating to skin, eyes and mucous membranes.	2461
2463	ALUMINIUM HYDRIDE	4.3	-	I	-	0	ED	P403	PP31	-	-	-	-	F-C, S-O	Category E	White to grey powder. In contact with water, acids or moisture, evolves hydrogen which may be ignited by the heat of the reaction.	2463
2464	BERYLLIUM NITRATE	5.1	6.1	II	-	1 kg	E2	P002	-	IBC08	B2 B4	T3	TP33	F-A, S-Q	Category A	White or light yellow deliquescent crystals, or fine dust. Mixture with combustible material is highly flammable and may burn fiercely. Toxic if swallowed, by skin contact or by dust inhalation.	2464
2465	DICHLOROISOCYANURIC ACID, DRY or DICHLOROISOCYANURIC ACID, SALTS	5.1	-	II	135	1 kg	E2	P002	-	IBC08	B2 B4	T3	TP33	F-A, S-Q	Category A. Keep as dry as reasonably practicable.	White crystalline powder or granules; slightly hygroscopic. Partially soluble in water. Mixtures with combustible material are sensitive to friction and are liable to ignite. Harmful by inhalation. Irritating to skin, eyes and mucous membranes.	2465
2466	POTASSIUM SUPEROXIDE	5.1	-	I	-	0	ED	P503	-	IBC06	B1	-	-	F-C, S-Q	Category E. Keep as dry as reasonably practicable.	Yellow flakes. Particularly if wetted with small quantities of water, a mixture with combustible material may ignite, following impact or friction. When involved in a fire, or in contact with water or acids, decomposes, evolving oxygen. Highly irritating to skin, eyes and mucous membranes.	2466
2468	TRICHLOROISOCYANURIC ACID, DRY	5.1	-	II	-	1 kg	E2	P002	-	IBC08	B2 B4	T3	TP33	F-A, S-Q	Category A. Keep as dry as reasonably practicable.	Colourless powder or granules. Mixtures with combustible material are sensitive to friction and are liable to ignite. On contact with nitrogen compounds, fumes of nitrogen trichloride can be formed, which are very corrosive. Harmful by inhalation. Irritating to skin, eyes and mucous membranes.	2468
2469	ZINC BROMATE	5.1	-	III	-	5 kg	E1	P002 LP02	-	IBC08	B3	T1	TP33	F-H, S-Q	Category A. "Separated from" ammonium compounds and cyanides.	Colourless powder. Soluble in water. Reacts vigorously with sulphuric acid. Reacts fiercely with cyanides when heated or by friction. May form explosive mixtures with combustible material, powdered metals or ammonium compounds. These mixtures are sensitive to friction and are liable to ignite. When involved in a fire may cause an explosion.	2469
2470	PHENYLACETONITRILE, LIQUID	6.1	-	III	-	5 l	E1	P001 LP01	-	IBC03	-	T4	TP1	F-A, S-A	Category A	Colourless to light brown liquid. Immiscible with water. Toxic if swallowed, by skin contact or by inhalation.	2470
2471	OSMIUM TETROXIDE	6.1	P	I	-	0	ES	P002	PP30 PP31	IBC07	B1	T6	TP33	F-A, S-A	Category B	Pale yellow, crystalline, volatile solid with an irritating odour. Highly toxic if swallowed, by skin contact or by inhalation.	2471
2473	SODIUM ARSANILATE	6.1	-	III	-	5 kg	E1	P002 LP02	-	IBC08	B3	T1	TP33	F-A, S-A	Category A	White, crystalline powder. Soluble in water. Toxic if swallowed, by skin contact or by dust inhalation.	2473
2474	THIOPHOSGENE	6.1	-	I	279 354	0	ED	P602	-	-	-	T20	TP2 TP3 TP37	F-A, S-A	Category D. Clear of living quarters. Separated from acids.	Red fuming liquid with a foul, phosgene-like odour. Decomposes slowly in water. Reacts with acids, evolving toxic and corrosive fumes. Highly toxic if swallowed, by skin contact or by inhalation.	2474
2475	VANADIUM TRICHLORIDE	8	-	III	-	5 kg	E1	P002 LP02	-	IBC08	B3	T1	TP33	F-A, S-B	Category A	Pink, deliquescent crystals. Decomposes in water, evolving hydrogen chloride, a corrosive gas apparent as white fumes. In the presence of moisture, highly corrosive to most metals. Irritating to skin, eyes and mucous membranes.	2475
2477	METHYL ISOTHIOCYANATE	6.1	3	I	354	0	ED	P602	-	-	-	T20	TP2 TP3 TP37	F-E, S-D	Category D. Clear of living quarters.	White crystals. Usually shipped as an oily liquid with a flashpoint below 60°C c.c. Melting point: 36°C (pure substance). Flashpoint: 32°C c.c. (pure substance). Insoluble in water. When involved in a fire, evolves toxic gases. Highly toxic if swallowed, by skin contact or by inhalation.	2477
2478	ISOCYANATES, FLAMMABLE; TOXIC, N.O.S. or ISOCYANATE SOLUTION, FLAMMABLE, TOXIC, N.O.S.	3	6.1	II	274	1 l	E2	P001	PP31	IBC02	-	T11	TP2 TP3 TP37	F-E, S-D	Category D. Clear of living quarters.	Flammable toxic liquids with a pungent odour. Immiscible with water but react with it to form carbon dioxide. Toxic if swallowed, by skin contact or by inhalation. Irritating to skin, eyes and mucous membranes.	2478

**TSFS 2015:66  
Bilaga 1**

UN No. (1)	PSN (2)	Class No. or Div. (5)	Subsidiary Risk(s) (4)	Packing (3)	Special Provisions (6)	Limited quantities (7a)	Excepted quantities (7b)	Packing			IBC		
								Instruc-tions (8)	Provisions (9)	Instruc-tions (10)	Provisions (11)		
3.1.2		2.0	2.0	2.0, 1.3	3.3	3.4	3.5	4.1, 4	4.1, 4	4.1, 4			
2478	ISOCYANATES, FLAMMABLE, TOXIC, N.O.S. or ISOCYANATE SOLUTION, FLAMMABLE, TOXIC, N.O.S.	3	6.1	III	223 Z74	5 ℓ	E1	P001	IBC03	-			

Tank instructions (15)	Provisions (14)	EMs (15)	Stowage and Segregation (16)	Properties and Observations (17)	UN No. (18)

See entry above.

T7 TP1  
TP2  
TP3  
TP9  
TP9B

F-E, S-D

Category A.

2478

2480	METHYL ISOCYANATE	6.1	3	I	354	0	EO	P601	-	-	-	-	-	-	2480
------	-------------------	-----	---	---	-----	---	----	------	---	---	---	---	---	---	------

2481	ETHYL ISOCYANATE	6.1	3	I	354	0	EO	P602	-	-	-	-	-	-	2481
------	------------------	-----	---	---	-----	---	----	------	---	---	---	---	---	---	------

2482	n-PROPYL ISOCYANATE	6.1	3	I	354	0	EO	P602	-	-	-	-	-	-	2482
------	---------------------	-----	---	---	-----	---	----	------	---	---	---	---	---	---	------

2483	ISOPROPYL ISOCYANATE	6.1	3	I	354	0	EO	P602	-	-	-	-	-	-	2483
------	----------------------	-----	---	---	-----	---	----	------	---	---	---	---	---	---	------

2484	tert-BUTYL ISOCYANATE	6.1	3	I	354	0	EO	P602	-	-	-	-	-	-	2484
------	-----------------------	-----	---	---	-----	---	----	------	---	---	---	---	---	---	------

2485	n-BUTYL ISOCYANATE	6.1	3	I	354	0	EO	P602	-	-	-	-	-	-	2485
------	--------------------	-----	---	---	-----	---	----	------	---	---	---	---	---	---	------

2486	ISOBUTYL ISOCYANATE	6.1	3	I	354	0	EO	P602	-	-	-	-	-	-	2486
------	---------------------	-----	---	---	-----	---	----	------	---	---	---	---	---	---	------

2487	PHENYL ISOCYANATE	6.1	3	I	354	0	EO	P602	-	-	-	-	-	-	2487
------	-------------------	-----	---	---	-----	---	----	------	---	---	---	---	---	---	------

2488	CYCLOHEXYL ISOCYANATE	6.1	3	I	354	0	EO	P602	-	-	-	-	-	-	2488
------	-----------------------	-----	---	---	-----	---	----	------	---	---	---	---	---	---	------

2490	DICHLORISOPROPYL ETHER	6.1	-	II	-	100 ml	E4	P001	-	IBC02	-	-	-	-	2490
------	------------------------	-----	---	----	---	--------	----	------	---	-------	---	---	---	---	------

2491	ETHANOLAMINE or ETHANOLAMINE SOLUTION	8	-	III	223	5 ℓ	E1	P001 LP01	-	IBC03	-	-	-	-	2491
------	---------------------------------------	---	---	-----	-----	-----	----	--------------	---	-------	---	---	---	---	------

2493	HEXAMETHYLENEMINE	3	8	II	-	1 ℓ	E2	P001	-	IBC02	-	-	-	-	2493
------	-------------------	---	---	----	---	-----	----	------	---	-------	---	---	---	---	------



UN No. (1)	PSN (2)	Class No. (3)	Subsidiary Risk(s) (4)	Packing Group (5)	Special Provisions (6)	Limited quantities (7a)	Excepted quantities (7b)	Packing			IBC	
								Instruc-tions (8)	Provisions (9)	Instruc-tions (10)	Provisions (11)	
3.1.2		2.0	2.0	2.0	3.3	3.4	3.5	4.1,4	4.1,4	4.1,4	4.1,4	
2495	IODINE PENTAFLUORIDE	5.1	6.1/8	I	-	0	E0	P200	-	-	-	2495

Category D. Protected from sources. Colourless, fuming liquid (density 3.75). Powerful oxidant; may cause fire with water, evolving hydrogen fluoride, a toxic, extremely corrosive gas. In contact with acids or acid fumes evolves highly toxic fumes of iodine, fluorine and their compounds. Highly corrosive to most metals. Toxic if swallowed, by skin contact or by inhalation. Causes burns to skin, eyes and mucous membranes.

Colourless, combustible liquid with a pungent odour. Reacts with water, forming propionic acid. Corrosive to skin, eyes and mucous membranes.

Colourless liquid. Flashpoint: 57°C o.c. Immiscible with water.

Aqueous solution. Miscible with water. Toxic if swallowed, by skin contact or by inhalation.

See entry above.

Liquid with a penetrating odour. Flashpoint: 23°C c.c. or above. Reacts with water, evolving hydrogen chloride, a corrosive gas as well as white fumes. Causes burns to skin, eyes and mucous membranes.

White, lustrous crystals. Reacts with water, evolving hydrogen chloride, a corrosive gas as well as white fumes. In the presence of moisture, corrosive to most metals. Irritating to mucous membranes.

Colourless to yellowish liquid with a camphor-like odour. Toxic if swallowed; by skin contact or by inhalation.

Colourless crystals or powder with an ammonia-like odour. Readily soluble in water. Decomposes in contact with acids, evolving hydrogen fluoride, a corrosive gas. Toxic if swallowed, by skin contact or by dust inhalation.

White, rhombic crystals. Soluble in water. When involved in a fire, evolves extremely irritating and corrosive fumes. In the presence of moisture, corrosive to most metals. Causes burns to skin, eyes and mucous membranes.

Red-brown crystals. Soluble in water.

Black or green-black crystals. Hygroscopic. Reacts violently with water, evolving hydrogen chloride, a corrosive gas as well as white fumes. Harmful if swallowed. Dust and vapour irritate skin, eyes and mucous membranes.

Colourless crystals. Soluble in water. When involved in a fire, evolves extremely irritating and corrosive fumes. In the presence of moisture, corrosive to most metals. Irritating to skin, eyes and mucous membranes.

Colourless, aqueous solution with a specific odour. Causes burns to skin, eyes and mucous membranes.

White or brownish (ortho- and para-) or reddish-yellow (meta-) crystals. Soluble in water. Toxic if swallowed, by skin contact or by inhalation.

UN No. (1)	PSN (2)	Class No. or Div (5)	Subsidiary Risk(s) (4)	Packing Group (3)	Special Provisions (6)	Limited quantities (7a)	Excepted quantities (7b)	Packing			IBC		
								Instruc-tions (8)	Provisions (9)	Instruc-tions (10)	Provisions (11)		
3.1.2		2.0	2.0	2.0, 1.3	3.3	3.4	3.5	4.1, 4	4.1, 4	4.1, 4	4.1, 4		
8				II		1 ℓ	E2	P001				IBC02	B20

2513 BROMOACETYL BROMIDE  
 Clear liquid, colourless. Boiling point: 150°C. Reacts violently with water, forming hydrogen bromide. Corrosive to metals. Causes severe burns to skin, eyes and mucous membranes. Vapour causes tears. Reacts violently with alkalis such as ammonia and hydrazine. Causes very severe burns to skin, eyes and mucous membranes. Vapour causes tears. Explosive limits: 0.5% to 2.8%. Immiscible with water.

2514 BROMOBENZENE  
 Colourless liquid with a characteristic odour. Flashpoint: 51°C c.c.

2515 BROMOFORM  
 Colourless liquid or crystals (melting point 9°C with a chloroform-like odour. Toxic if swallowed, by skin contact or by inhalation. Narcotic effect.

2516 CARBON TETRAFLUORIDE  
 Colourless crystals. Melting point: 48°C. Insoluble in water. Toxic if swallowed, by skin contact or by inhalation of dust and vapour.

2517 1-CHLORO-1,1-DIFLUOROETHANE (REFRIGERANT GAS R 142b)  
 Flammable gas. Explosive limits: 8.5% to 14%. Much heavier than air (3.5).

2518 1,5,9-CYCLOODECADIENE  
 Colourless liquid. Toxic if swallowed, by skin contact or by inhalation.

2520 CYCLOOCTADIENES  
 Colourless liquids. Immiscible with water. 1,5-CYCLOOCTADIENE flashpoint 38°C c.c. Irritating to skin, eyes and mucous membranes.

2521 DIKETENE STABILIZED  
 Colourless flammable liquid with a pungent odour. Flashpoint: 44°C c.c. Immiscible with water, but hydrolyses slowly in contact with it. The presence of acids, bases or amines can initiate explosive polymerization. Highly toxic if swallowed, by skin contact or by inhalation.

2522 2-DIMETHYLAMINOETHYL METHACRYLATE  
 Combustible liquid. Causes tears. Toxic if swallowed, by skin contact or by inhalation.

2524 ETHYLORTHOFORMATE  
 Colourless liquid with an ethereal odour. Flashpoint: 30°C c.c. Immiscible with water.

2525 ETHYL OXALATE  
 Colourless, oily, aromatic liquid. Slowly decomposed by water. Toxic if swallowed, by skin contact or by dust inhalation.

2526 FURFURYLAMINE  
 Pale yellow, oily liquid. Flashpoint: 37°C o.c. Miscible with water. Harmful by inhalation. Causes burns to skin and eyes. Irritating to mucous membranes.

2527 ISOBUTYL ACRYLATE, STABILIZED  
 Colourless liquid with a pungent odour. Flashpoint: 30°C c.c. Immiscible with water. Harmful by inhalation. Irritating to skin, eyes and mucous membranes.

2528 ISOBUTYL ISOBUTYRATE  
 Colourless liquid with a fruity odour. Flashpoint: 37°C c.c. Explosive limits: 0.98% to 7.59%. Immiscible with water.

2529 ISOBUTYRIC ACID  
 Colourless liquid with a pungent odour. Flashpoint: 55°C c.c. Explosive limits: 2% to 9.2%. Miscible with water. Causes burns to skin and eyes. Irritating to skin, eyes and mucous membranes.

UN No. (1)	PSN (2)	Class No. or Div (5)	Subsidiary Risk(s) (4)	Packing Group (3)	Special Provisions (6)	Limited quantities (7a)	Excepted quantities (7b)	Packing			IBC		
								Instruc-tions (8)	Provisions (9)	Instruc-tions (10)	Provisions (11)		
4.2.5	4.2.5	4.2.5	4.3	4.3	7.1 to 7.7								

2513 BROMOACETYL BROMIDE  
 Clear liquid, colourless. Boiling point: 150°C. Reacts violently with water, forming hydrogen bromide. Corrosive to metals. Causes severe burns to skin, eyes and mucous membranes. Vapour causes tears. Reacts violently with alkalis such as ammonia and hydrazine. Causes very severe burns to skin, eyes and mucous membranes. Vapour causes tears. Explosive limits: 0.5% to 2.8%. Immiscible with water.

2514 BROMOBENZENE  
 Colourless liquid with a characteristic odour. Flashpoint: 51°C c.c.

2515 BROMOFORM  
 Colourless liquid or crystals (melting point 9°C with a chloroform-like odour. Toxic if swallowed, by skin contact or by inhalation. Narcotic effect.

2516 CARBON TETRAFLUORIDE  
 Colourless crystals. Melting point: 48°C. Insoluble in water. Toxic if swallowed, by skin contact or by inhalation of dust and vapour.

2517 1-CHLORO-1,1-DIFLUOROETHANE (REFRIGERANT GAS R 142b)  
 Flammable gas. Explosive limits: 8.5% to 14%. Much heavier than air (3.5).

2518 1,5,9-CYCLOODECADIENE  
 Colourless liquid. Toxic if swallowed, by skin contact or by inhalation.

2520 CYCLOOCTADIENES  
 Colourless liquids. Immiscible with water. 1,5-CYCLOOCTADIENE flashpoint 38°C c.c. Irritating to skin, eyes and mucous membranes.

2521 DIKETENE STABILIZED  
 Colourless flammable liquid with a pungent odour. Flashpoint: 44°C c.c. Immiscible with water, but hydrolyses slowly in contact with it. The presence of acids, bases or amines can initiate explosive polymerization. Highly toxic if swallowed, by skin contact or by inhalation.

2522 2-DIMETHYLAMINOETHYL METHACRYLATE  
 Combustible liquid. Causes tears. Toxic if swallowed, by skin contact or by inhalation.

2524 ETHYLORTHOFORMATE  
 Colourless liquid with an ethereal odour. Flashpoint: 30°C c.c. Immiscible with water.

2525 ETHYL OXALATE  
 Colourless, oily, aromatic liquid. Slowly decomposed by water. Toxic if swallowed, by skin contact or by dust inhalation.

2526 FURFURYLAMINE  
 Pale yellow, oily liquid. Flashpoint: 37°C o.c. Miscible with water. Harmful by inhalation. Causes burns to skin and eyes. Irritating to mucous membranes.

2527 ISOBUTYL ACRYLATE, STABILIZED  
 Colourless liquid with a pungent odour. Flashpoint: 30°C c.c. Immiscible with water. Harmful by inhalation. Irritating to skin, eyes and mucous membranes.

2528 ISOBUTYL ISOBUTYRATE  
 Colourless liquid with a fruity odour. Flashpoint: 37°C c.c. Explosive limits: 0.98% to 7.59%. Immiscible with water.

2529 ISOBUTYRIC ACID  
 Colourless liquid with a pungent odour. Flashpoint: 55°C c.c. Explosive limits: 2% to 9.2%. Miscible with water. Causes burns to skin and eyes. Irritating to skin, eyes and mucous membranes.

UN No. (1)	PSN (2)	Class No. (3)	Subsidiary Risk(s) (4)	Packing Group (5)	Special Provisions (6)	Limited quantities (7a)	Excepted quantities (7b)	Packing			IBC			Portable tanks and bulk containers	EMSS (15)	Stowage and Segregation (16)	Properties and Observations (17)	UN No. (18)
								Class (8)	Packing (9)	Instructions (10)	Instructions (11)	Provisions (12)	Instructions (13)					
2531	METHACRYLIC ACID, STABILIZED	8	-	II	-	1 ℓ	E2	P001	-	IBC02	-	-	T7	F-A, S-B	Category C. Clear of living quarters.	Colourless, combustible liquid with a specific odour. Miscible with water. Harmful if swallowed. Irritating to skin. May cause drowsiness or dizziness.	2531	
2533	METHYLTRICHLOROACETATE	6.1	-	III	-	5 ℓ	E1	P001 LP01	-	IBC03	-	-	T4	F-A, S-A	Category A.	Colourless liquid. Immiscible with water. Toxic if swallowed, by skin contact or by inhalation.	2533	
2534	METHYLCHLOROSILANE	2.3	2.1/8	-	-	0	E0	P200	-	-	-	-	-	F-D, S-U	Category D. Clear of living quarters. Segregation as per class 2.1 but "Away from" class 4.3.	Liquidified, flammable, toxic and corrosive colourless gas with a pungent odour. Reacts with water, evolving hydrogen chloride, an irritating and corrosive gas. Heavier than air. Boiling point: 9°C. Highly irritating to skin, eyes and mucous membranes.	2534	
2535	4-METHYLMORPHOLINE (N-METHYLMORPHOLINE)	3	8	II	-	1 ℓ	E2	P001	-	IBC02	-	-	T7	F-E, S-C	Category B. Clear of living quarters.	Colourless liquid with an ammonia-like odour. Flashpoint: 13°C C.c. Miscible with water. Harmful by inhalation. Causes burns to skin and eyes. Irritating to mucous membranes.	2535	
2536	METHYLTRIBUTYLDIBORANE	3	-	II	-	1 ℓ	E2	P001	-	IBC02	-	-	T4	F-E, S-D	Category B.	Colourless, volatile liquid with an ether-like odour. Flashpoint: -11°C o.c. Immiscible with water.	2536	
2538	NITRONAPHTHALENE	4.1	-	III	-	5 kg	E1	P002 LP02	-	IBC08	B3	-	T1	F-A, S-G	Category A.	Yellow crystals. Insoluble in water. Harmful if swallowed.	2538	
2541	TERPINOLENE	3	-	III	-	5 ℓ	E1	P001 LP01	-	IBC03	-	-	T2	F-E, S-E	Category A.	Colourless to pale amber liquid with a lemon odour. Flashpoint: 37°C C.c. Immiscible with water.	2541	
2542	TRIBUTYLAMINE	6.1	-	II	-	100 ml	E4	P001	-	IBC02	-	-	T7	F-A, S-A	Category A.	Colourless, combustible liquid with an amine odour. Immiscible with water. Evolves toxic gases. Toxic if swallowed, by skin contact or by inhalation.	2542	
2545	HAFNIUM POWDER, DRY	4.2	-	I	-	0	E0	P404	PP31	-	-	-	-	F-G, S-M	Category D.	Black, amorphous powder. Insoluble in water. Liable to ignite spontaneously in air. Forms explosive mixtures with oxidizing substances.	2545	
2545	HAFNIUM POWDER, DRY	4.2	-	II	-	0	E2	P410	PP31	IBC06	B2	-	T3	F-G, S-M	Category D.	See entry above.	2545	
2545	HAFNIUM POWDER, DRY	4.2	-	III	223	0	E1	P002 LP02	PP31	IBC08	B3	-	T1	F-G, S-M	Category D.	See entry above.	2545	
2546	TITANIUM POWDER, DRY	4.2	-	I	-	0	E0	P404	PP31	-	-	-	-	F-G, S-M	Category D.	Grey powder. Liable to ignite spontaneously in air. Forms explosive mixtures with oxidizing substances.	2546	
2546	TITANIUM POWDER, DRY	4.2	-	II	-	0	E2	P410	PP31	IBC06	B2	-	T3	F-G, S-M	Category D.	See entry above.	2546	
2546	TITANIUM POWDER, DRY	4.2	-	III	223	0	E1	P002 LP02	PP31	IBC08	B3	-	T1	F-G, S-M	Category D.	See entry above.	2546	
2547	SODIUM SUPEROXIDE	5.1	-	I	-	0	E0	P503	-	IBC06	B1	-	-	F-G, S-Q	Category E. Keep as dry as reasonably practicable. Separated from ammonium salts, acids and organic materials, peroxides, class 4.1.	Pale yellow coarse powder or granules. Particularly if wetted with small quantities of water, a mixture with combustible material may ignite, and may decompose, evolve oxygen, water or acids, decomposes, evolving oxygen. Highly irritating to skin, eyes and mucous membranes.	2547	

# TSFS 2015:66 Bilaga 1

UN No. (1)	PSN (2)	Class No. (3)	Subsidiary Risk(s) (4)	Packing Group (5)	Special Provisions (6)	Limited quantities (7a)	Excepted quantities (7b)	Packing			IBC	
								Instruc-tions (8)	Provisions (9)	Instruc-tions (10)	Provisions (11)	
31.2		2.0	2.0	2.0	3.3	3.4	3.5	4.1, 4	4.1, 4	4.1, 4		

Tank instructions (15)	Provisions (14)	EMs (15)	Stowage and Segregation (16)	Properties and Observations (17)	UN No. (18)

2548	CHLORINE PENTAFLUORIDE	2.3	5.1/8	-	-	0	E0	P200	-	-	-	-	F-C, S-W	Category D. Clear of living quarters, clear of living quarters, class 3.1 but "Separated from" Class 7.	Non-flammable, toxic and corrosive gas. Forms dense, white, corrosive vapour. Harmful by inhalation. Toxic, irritating and corrosive gas appearing as white fumes. Corrosive to glass and to most metals. Powerful oxidizing agent which may cause violent fires with combustible materials. Much heavier than air (4.5). Highly irritating to skin, eyes and mucous membranes.	2548	
2552	HEXAFLUOROACETONE HYDRATE, LIQUID	6.1	-	II	-	100 ml <sup>f</sup>	E4	P001	-	IBC02	-	-	TP2	F-A, S-A	Category B. Clear of living quarters.	Toxic if swallowed, by skin contact or by inhalation.	2552
2554	METHYLVINYL CHLORIDE	3	-	II	-	1 l <sup>f</sup>	E2	P001	-	IBC02	-	-	TP1 TP13	F-E, S-D	Category E.	Colourless to yellowish, volatile liquid with a penetrating odour. Flashpoint: -12°C c.c. Explosive limits: 2.3% to 9.3%. Immiscible with water. When involved in a fire, may evolve highly toxic phosgene gas. Harmful by inhalation. Irritating to skin, eyes and mucous membranes.	2554
2555	NITROCELLULOSE WITH WATER (not less than 25% by mass)	4.1	-	II	2.8	0	E0	P406	PP31	-	-	-	-	F-B, S-J	Category E. "Away from" class 3 and heavy metals and their salts.	Desensitized explosive. Nitrocellulose may be granular or in flakes, blocks or fibrous form. When involved in a fire, evolves toxic fumes; in closed compartments, these fumes may form an explosive mixture with air. May form extremely sensitive compounds with heavy metals or their salts.	2555
2556	NITROCELLULOSE WITH ALCOHOL (not less than 25% alcohol, by mass, and not more than 12.6% nitrogen, by dry mass)	4.1	-	II	2.8	0	E0	P406	PP31	-	-	-	-	F-B, S-J	Category D. "Away from" class 3 and heavy metals and their salts.	Nitrocellulose may be granular or in flakes, blocks or fibrous form. In case of leakage, flammable vapours are evolved which, in closed compartments, these fumes may form an explosive mixture with air. When involved in a fire, evolves toxic fumes; in closed compartments, these fumes may form an explosive mixture with air. Highly explosive when dry. May form extremely sensitive compounds with heavy metals or their salts.	2556
2557	NITROCELLULOSE with not more than 12.6% nitrogen, by dry mass, MIXTURE WITH or WITHOUT PLASTICIZER, WITH or WITHOUT PROMPT	4.1	-	II	2.41	0	E0	P406	PP31	-	-	-	-	F-B, S-J	Category D. "Away from" class 3 and heavy metals and their salts.	Nitrocellulose may be in granular form or in flakes. This product may also contain added pigments. When involved in a fire, evolves toxic fumes; in closed compartments, these fumes may form an explosive mixture with air. When involved in a fire, evolves toxic fumes; in closed compartments, these fumes should be prepared so that it remains homogeneous and does not separate during transport. May form extremely sensitive compounds with heavy metals or their salts.	2557
2558	EPIBROMOHYDRIN	6.1	3	I	-	0	E5	P001	-	-	-	-	T1,4 TP13	F-E, S-D	Category D. Clear of living quarters.	Flammable liquid. Flashpoint: 56°C c.c. Highly toxic if swallowed, by skin contact or by inhalation.	2558
2560	2-METHYLPENTAN-2-OL	3	-	III	-	5 l <sup>f</sup>	E1	P001 LP01	-	IBC03	-	-	T2	F-E, S-D	Category A.	Colourless liquid. Flashpoint: 30°C c.c. Partially miscible with water. Irritating to skin, eyes and mucous membranes.	2560
2561	3-METHYL-1-BUTENE	3	-	I	-	0	E3	P001	-	-	-	-	T1,1	F-E, S-D	Category E.	Colourless, volatile liquid with a disagreeable odour. Flashpoint: below -18°C c.c. Immiscible with water. Irritating to skin, eyes and mucous membranes.	2561
2564	TRICHLOROACETIC ACID SOLUTION	8	-	II	-	1 l <sup>f</sup>	E2	P001	-	IBC02	-	-	T7	F-A, S-B	Category B.	Colourless, clear solution with a pungent odour. Corrosive to most metals. Causes burns to skin, eyes and mucous membranes.	2564
2564	TRICHLOROACETIC ACID SOLUTION	8	-	III	2.23	5 l <sup>f</sup>	E1	P001 LP01	-	IBC03	-	-	T4	F-A, S-B	Category B.	See entry above.	2564
2565	DICYCLOHEXYLAMINE	8	-	III	-	5 l <sup>f</sup>	E1	P001 LP01	-	IBC03	-	-	T4	F-A, S-B	Category A.	Clear, colourless, combustible liquid with a fishy odour which may impart a disagreeable odour to water. Causes burns to skin, eyes and mucous membranes.	2565
2567	SODIUM PENTACHLOROPHENATE	6.1	P	II	-	500 g	E4	P002	-	IBC08	B2 B4	-	T3	F-A, S-A	Category A.	White or light brown powder with a pungent odour. Soluble in water. Toxic if swallowed, by skin contact or by dust inhalation.	2567
2570	CADMIUM COMPOUND	6.1	-	I	2.74	0	E5	P002	-	IBC07	B1	-	T6	F-A, S-A	Category A.	Powder or crystals with various colours. May be soluble or insoluble in water. Toxic if swallowed, by skin contact or by dust inhalation.	2570
2570	CADMIUM COMPOUND	6.1	-	II	2.74	500 g	E4	P002	-	IBC08	B2 B4	-	T3	F-A, S-A	Category A.	See entry above.	2570

UN No. (1)	PSN (2)	Class No. or Div (3)	Subsidiary Risk(s) (4)	Packing Group (5)	Special Provisions (6)	Limited quantities (7a)	Excepted quantities (7b)	Packing		IBC	
								Instruct-ions (8)	Provisions (9)	Instruc-tions (10)	Provisions (11)
	3.1.2	2.0	2.0	2.0	2.0	3.3	3.4	3.5	4.1, 4	4.1, 4	4.1, 4
2570	CADMIUM COMPOUND	6.1	-	III	223 274	5 kg	E1	P002 LP02	-	IBC08	B3

UN No. (16)	Properties and Observations (17)	Portable tanks and bulk containers		Storage and Segregation (18)	Category A.
		Tank instructions (15)	Provisions (14)		
		4.2.5 4.3	4.2.5 7.8	54.3.2 7.8	7.1 to 7.7
2571	See entry above.	TI	TP23	F-A, S-A	Category A.

2571	ALKYLSULPHURIC ACIDS	8	-	II	-	1 ℓ	E2	P001	-	IBC02	-	TP2 TP13 TP28	F-A, S-B	Category C. For metal drums, category B.	Colourless oily liquids. React with water, evolving heat. Causes burns to skin, eyes and mucous membranes. Highly corrosive to metal.	2571	
2572	PHENYLHYDRAZINE	6.1	-	II	-	100 ml	E4	P001	-	IBC02	-	T7	F-A, S-A	Category A. Clear of living quarters.	Pale yellow oily liquid. Melting point: 20°C. Slightly soluble in water. Toxic if swallowed, by skin contact or by inhalation.	2572	
2573	THALLIUM CHLORATE	5.1	6.1 P	II	-	1 kg	E2	P002	-	IBC06	B2	T3	F-H, S-Q	Category A. "Separated from" other than from compounds and oxides.	Colourless crystals. Slightly soluble in water. Reacts vigorously with water to form a toxic solution. May form explosive mixtures with combustible material, powdered metals or ammonium compounds. These mixtures are sensitive to friction and are liable to ignite. When involved in a fire may cause an explosion. Toxic if swallowed, by skin contact or by dust inhalation.	2573	
2574	TRICRESYL PHOSPHATE with more than 3% ortho-isomer	6.1	- P	II	-	100 ml	E4	P001	-	IBC02	-	T7	F-A, S-A	Category A.	Colourless liquid. A mixture of isomers. Immiscible with water. Toxic if swallowed, by skin contact or by inhalation.	2574	
2576	PHOSPHORUS OXYBROMIDE, MOLTEN	8	-	II	-	0	E0	-	-	-	-	T7	TP3 TP13	F-A, S-B	Category C. Clear of living quarters.	Colourless liquid with a pungent odour. Melting point: 56°C. Reacts violently with water, evolving hydrogen bromide, a toxic and corrosive gas apparent as white fumes. Reacts violently with organic materials (such as wood, paper, cloth, etc.) to form a highly exothermic reaction. Toxic to most metals. Vapours and liquid cause burns to skin, eyes and mucous membranes. Shipped molten above its melting point.	2576
2577	PHENYLACETYL CHLORIDE	8	-	II	-	1 ℓ	E2	P001	-	IBC02	-	T7	TP2	F-A, S-B	Category C. Clear of living quarters.	Colourless liquid with a pungent odour. Reacts with water, evolving hydrogen chloride, an irritating and corrosive gas apparent as white fumes. When involved in a fire, evolves highly toxic fumes. Corrosive to skin, eyes and mucous membranes. Liquid is corrosive to skin, eyes and mucous membranes.	2577
2578	PHOSPHORUS TRIOXIDE	8	-	III	-	5 kg	E1	P002 LP02	-	IBC08	B3	T1	TP33	F-A, S-B	Category A. Keep as cool as reasonably practicable.	Colourless crystals or white deliquescent powder. Melting point: 37°C. Reacts with water, evolving heat and at normal temperatures phosphoric acid, but at higher temperatures phosphine, a highly toxic gas. In the presence of moisture, corrosive to most metals. Causes burns to skin, eyes and mucous membranes.	2578
2579	PIPERAZINE	8	-	III	-	5 kg	E1	P002 LP02	-	IBC08	B3	T1	TP33	F-A, S-B	Category A. Keep as cool as reasonably practicable. "Separated from acids."	Colourless, deliquescent crystals, turning dark on exposure to light. Soluble in water. Decomposes when heated and when involved in a fire, evolves highly toxic fumes. Corrosive to skin, eyes and mucous membranes and is highly corrosive. Reacts violently with acids. Irritating to skin, eyes and mucous membranes.	2579
2580	ALUMINIUM BROMIDE SOLUTION	8	-	III	223	5 ℓ	E1	P001 LP01	-	IBC03	-	T4	TP1	F-A, S-B	Category A.	Colourless to yellowish liquid. Highly corrosive to most metals. Vapour highly irritating to skin, eyes and mucous membranes. Liquid causes severe burns to skin, eyes and mucous membranes.	2580
2581	ALUMINIUM CHLORIDE SOLUTION	8	-	III	223	5 ℓ	E1	P001 LP01	-	IBC03	-	T4	TP1	F-A, S-B	Category A.	Colourless to yellowish liquid. Highly corrosive to most metals. Vapour highly irritating to skin, eyes and mucous membranes. Liquid causes severe burns to skin, eyes and mucous membranes.	2581
2582	FERRIC CHLORIDE SOLUTION	8	-	III	223	5 ℓ	E1	P001 LP01	-	IBC03	-	T4	TP1	F-A, S-B	Category A.	Colourless to light brown liquid. Highly corrosive to most metals.	2582
2583	ALKYLSULPHONIC ACIDS, SOLID or ARYLSULPHONIC ACIDS, SOLID with more than 5% free sulphuric acid	8	-	II	-	1 kg	E2	P002	-	IBC08	B2 B4	T3	TP33	F-A, S-B	Category A.	When involved in a fire, evolve highly toxic gases. Corrosive to most metals, especially in the presence of moisture. Cause burns to skin, eyes and mucous membranes.	2583
2584	ALKYLSULPHONIC ACIDS, LIQUID or ARYLSULPHONIC ACIDS, LIQUID with more than 5% free sulphuric acid	8	-	II	-	1 ℓ	E2	P001	-	IBC02	B20	T8 TP13	TP2 TP13	F-A, S-B	Category B.	Liquids usually with a pungent odour. When involved in a fire, evolve highly toxic gases. Highly corrosive to most metals. Cause burns to skin, eyes and mucous membranes.	2584

**TSFS 2015:66**  
**Bilaga 1**

UN No. (1)	PSN (2)	Class No. (5)	Subsidiary Risk(s) (4)	Packing Group (3)	Special Provisions (6)	Limited quantities (7a)	Excepted quantities (7b)	Packing		IBC		Portable tanks and bulk containers	EMs (15)	Storage and Segregation (16)	Properties and Observations (17)	UN No. (18)
								Instruc-tions (8)	Provisions (9)	Instruc-tions (10)	Provisions (11)					
2585	ALKYLsulPHONIC ACIDS, SOLID or ARYLsulPHONIC ACIDS, SOLID with not more than 3% free sulphuric acid	8	-	III	-	5 kg	E1	P002 LP02	-	IBC08	B3	T1	TP33	F-A, S-B Category A	Crystalline solids. When involved in a fire, evolve highly toxic gases. In the event of a spill, highly toxic to most metals. Cause burns to skin, eyes and mucous membranes.	2585
2586	ALKYLsulPHONIC ACIDS, LIQUID or ARYLsulPHONIC ACIDS, LIQUID with not more than 3% free sulphuric acid	8	-	III	-	5 ℓ	E1	P001 LP01	-	IBC03	-	T4	TP1	F-A, S-B Category B	Liquids, usually with a pungent odour. When involved in a fire, evolve highly toxic gases. Cause burns to skin, eyes and mucous membranes.	2586
2587	BENZOQUINONE	6.1	-	II	-	500 g	E4	P002	-	IBC08	B2 B4	T3	TP33	F-A, S-A Category A	Yellow crystals with an irritating and penetrating odour resembling that of chlorine. Slightly soluble in water. Toxic if swallowed, by skin contact or by dust inhalation.	2587
2588	PESTICIDE, SOLID, TOXIC, N.O.S.	6.1	-	I	61 274	0	E5	P002	-	IBC99	-	T6	TP33	F-A, S-A Category A	Solid pesticides present a very wide range of toxic hazard. Toxic if swallowed, by skin contact or by inhalation.	2588
2588	PESTICIDE, SOLID, TOXIC, N.O.S.	6.1	-	II	61 274	500 g	E4	P002	-	IBC08	B2 B4	T3	TP33	F-A, S-A Category A	Clear of living quarters. See entry above.	2588
2588	PESTICIDE, SOLID, TOXIC, N.O.S.	6.1	-	III	61 274	5 kg	E1	P002 LP02	-	IBC08	B3	T1	TP33	F-A, S-A Category A	Clear of living quarters. See entry above.	2588
2589	VINYlCHLOROACETATE	6.1	3	II	-	100 ml	E4	P001	-	IBC02	-	T7	TP2	F-E, S-D Category A	Flammable liquid. Flashpoint: 50°C c.c. Immiscible with water. Toxic if swallowed, by skin contact or by inhalation.	2589
2590	WHITE ASBESTOS (chrysothile, actinolite, anthophyllite, tremolite)	9	-	III	168	5kg	E1	P002	PF37	IBC08	B2 B3	T1	TP33	F-A, S-A Category A	Mineral fibres of varying length. Non-combustible. Inhalation of the dust of asbestos fibres is dangerous and therefore exposure should be avoided at all times. Always prevent the generation of asbestos dust. A safe level of exposure has not been established. Asbestos dusts are extremely effective packing. Cargo spaces or freight containers that have contained any type of raw asbestos should be carefully cleaned before discharging any remaining cargo, loading other cargo or carrying out repair or maintenance work. Whenever possible, cleaning of cargo spaces should be undertaken using high pressure water. High pressure water cleaning equipment, including proper respiratory apparatus and protective clothing, are available. Parts of the body that may have been exposed should be immediately and thoroughly washed. All waste material should be placed in approved bags for safe disposal. For safe disposal should be made in advance for cleaning out at the next port where necessary facilities are available. If cleaning of cargo spaces has to be carried out at sea, the safety procedures followed and standard of cleaning should be as high as possible. The cleaning of cargo spaces in employed in a port until such cleaning is undertaken, the cargo spaces in which the asbestos has been carried should be closed and access to those spaces should be prohibited.	2590
2591	XENON, REFRIGERATED LIQUID	2.2	-	-	-	120 ml	E1	P203	-	-	-	T75	TP5	F-C, S-V Category D	Liquefied, inert, colourless and odourless gas. Much heavier than air (4.5).	2591
2599	CHLOROTRIFLUOROMETHANE AND TRIFLUOROMETHANE AZEOTROPIC MIXTURE with approximately 60% chlorotrifluoromethane (REFRIGERANT CAS R 509)	2.2	-	-	-	120 ml	E1	P200	-	-	-	-	-	F-C, S-V Category A	Non-flammable, colourless gas with a mild etheral odour. Much heavier than air (3.2).	2599
2601	CYCLOBUTANE	2.1	-	-	-	0	E0	P200	-	-	-	-	-	F-D, S-U Category B	Liquefied, flammable, colourless gas. Explosive limits: 1.8% to 10%. Heavier than air (1.9). Boiling point: 13°C.	2601
2602	DICHLORODIFLUOROMETHANE AND DIFLUOROETHANE AZEOTROPIC MIXTURE with approximately 50% dichlorodifluoromethane (REFRIGERANT CAS R 500)	2.2	-	-	-	120 ml	E1	P200	-	-	-	T50	-	F-C, S-V Category A	Non-flammable, colourless and odourless gas. Much heavier than air (3.7).	2602
2603	CYCLOHEPTAENE	3	6.1	II	-	1 ℓ	E2	P001	-	IBC02	-	T7	TP1 TP13	F-E, S-D Category E	Colourless to dark yellow liquid with a characteristic odour. Flashpoint: 0°C to 4°C c.c. Immiscible with water. Reacts vigorously with oxidizing substances. Toxic if swallowed, by skin contact or by inhalation.	2603

UN No. (1)	PSN (2)	Class or Div (5)	Subsidiary Risk(s) (4)	Packing Group (3)	Special Provisions (6)	Limited quantities (7a)	Excepted quantities (7b)	Packing		IBC		Portable tanks and bulk containers		EMS (15)	Stowage and Segregation (16)	Properties and Observations (17)	UN No. (18)
								Instruc-tions (8)	Provisions (9)	Instruc-tions (10)	Provisions (11)	Tank instructions (12)	Provisions (13)				
2604	BORON TRIFLUORIDE DIETHYLETHEBATE	8	3	I	-	0	EO	P001	PPS1	-	-	T10	TP2	F-E, S-C	Category D. Clear of living quarters.	Colourless fuming flammable liquid. Flashpoint: 39°C c.c. The flashpoint is dependent on the concentration of the liquid. Corrosive to metals and flammable vapours. Decomposes in contact with water, evolving toxic and flammable vapours. Causes burns to skin, eyes and mucous membranes. Inhalation of small quantities of vapour can cause breathing difficulties.	2604
2605	METHOXYMETHYL ISOCYANATE	6.1	3	I	354	0	EO	P602	-	-	-	T20	TP2, TP3, TP37	F-E, S-D	Category D. Clear of living quarters.	Colourless liquid with a pungent odour. Flashpoint: 13°C c.c. Immiscible with water. Highly toxic if swallowed, by skin contact or by inhalation. Irritating to skin, eyes and mucous membranes.	2605
2606	METHYL ORTHOSILICATE	6.1	3	I	354	0	EO	P602	-	-	-	T20	TP2, TP3, TP37	F-E, S-D	Category D. Clear of living quarters.	Colourless, flammable liquid with an ethereal odour. Immiscible with water. Flashpoint: 18°C to 19°C c.c. Highly toxic if swallowed, by skin contact or by inhalation. May cause blindness.	2606
2607	ACROLEIN DIMER, STABILIZED	3	-	III	-	5 ℓ	E1	P001 LPO1	-	IBC03	-	T2	TP1	F-E, S-D	Category A. Clear of living quarters.	Colourless liquid with a pungent odour. Flashpoint: 48°C o.c. Miscible with water. Harmful by inhalation. Irritating to skin, eyes and mucous membranes.	2607
2608	NITROPANES	3	-	III	-	5 ℓ	E1	P001 LPO1	-	IBC03	-	T2	TP1	F-E, S-D	Category A.	Colourless liquids. Explosive limits: 2,2% to 11%. 1-NITROPANES: flash point approx. 33°C c.c. 2-NITROPANES: flash point approx. 28°C c.c. Partially miscible with water. Harmful by inhalation.	2608
2609	TRIALLYL BORATE	6.1	-	III	-	5 ℓ	E1	P001 LPO1	-	IBC03	-	-	-	F-A, S-A	Category A. Keep as dry as reasonably practicable.	Liquid. Hydrolyses in contact with water, forming allyl alcohol. Toxic if swallowed, by skin contact or by inhalation.	2609
2610	TRIALLYLAMINE	3	8	III	-	5 ℓ	E1	P001	-	IBC03	-	T4	TP1	F-E, S-C	Category A. Clear of living quarters.	Colourless liquid with a fishy odour. Flashpoint: 39°C o.c. Corrosive when in contact with water. Harmful by inhalation. Causes burns to skin and eyes. Irritating to mucous membranes.	2610
2611	PROPYLENE CHLOROHYDRIN	6.1	3	II	-	100 ml <sup>f</sup>	E4	P001	-	IBC02	-	T7	TP2, TP13	F-E, S-D	Category A. Keep as cool as reasonably practicable. Clear of living quarters.	Colourless flammable liquid with a mild odour. Flashpoint: 51°C c.c. Miscible with water. Decomposes when heated, evolving highly toxic fumes. Toxic if swallowed, by skin contact or by inhalation.	2611
2612	METHYL PROPYL ETHER	3	-	II	-	1 ℓ	E2	P001	-	IBC02	B8	T7	TP2	F-E, S-D	Category E. Clear of living quarters.	Colourless, volatile liquid with an ethereal odour. Flashpoint: below: -18°C c.c. Explosion limits: 2% to ... Boiling point: 39°C. Partially miscible with water. Narcotic. Irritating to skin, eyes and mucous membranes.	2612
2614	METHALLYL ALCOHOL	3	-	III	-	5 ℓ	E1	P001 LPO1	-	IBC03	-	T2	TP1	F-E, S-D	Category A.	Colourless liquid with a pungent odour. Flashpoint: 34°C c.c. Miscible with water. Irritating to skin, eyes and mucous membranes.	2614
2615	ETHYL PROPYL ETHER	3	-	II	-	1 ℓ	E2	P001	-	IBC02	-	T4	TP1	F-E, S-D	Category E.	Colourless, volatile liquids. Flashpoint: below: -18°C c.c. Explosion limits: 2% to ... Boiling point: 39°C. Partially miscible with water. Irritating to skin, eyes and mucous membranes.	2615
2616	TRISOPROPYL BORATE	3	-	II	-	1 ℓ	E2	P001	-	IBC02	-	T4	TP1	F-E, S-D	Category B.	Colourless liquid. Flashpoint: 17°C to 60°C C.c. Reacts with water, evolving flammable vapours.	2616
2616	TRISOPROPYL BORATE	3	-	III	223	5 ℓ	E1	P001 LPO1	-	IBC03	-	T2	TP1	F-E, S-D	Category A.	See entry above.	2616
2617	METHYLCYCLOHEXANOLS, flammable	3	-	III	-	5 ℓ	E1	P001 LPO1	-	IBC03	-	T2	TP1	F-E, S-D	Category A.	Colourless, viscous liquid with a menthol-like odour. Flashpoint: 58°C c.c. Partially miscible with water.	2617
2618	VINYLTOLUENES, STABILIZED	3	-	III	-	5 ℓ	E1	P001 LPO1	-	IBC03	-	T2	TP1	F-E, S-D	Category A.	Colourless liquids. Flashpoint: 54°C to 60°C c.c. Explosive limits: 0.9% to 6.1% Partially miscible with water. Harmful by inhalation. Irritating to skin, eyes and mucous membranes.	2618

**TSFS 2015:66**  
**Bilaga 1**

UN No. (1)	PSN (2)	Class or Div (5)	Subsidiary Risk(s) (4)	Packing Group (3)	Special Provisions (6)	Limited quantities (7a)	Excepted quantities (7b)	Packing		IBC		Portable tanks and bulk containers		Properties and Observations (17)	UN No. (18)		
								Instruc-tions (8)	Provisions (9)	Instruc-tions (10)	Provisions (11)	Tank instructions (15)	Provisions (14)			EMS (15)	Stowage and Segregation (16)
	3.1.2	2.0	2.0	2.0, 1.3	3.3	3.4	3.5	4.1, 4	4.1, 4	4.1, 4	4.1, 4	4.3	4.2, 5	5.4, 5.2	7.1 to 7.7		
2619	BENZYLDIMETHYLAMINE	8	3	II	-	1 ℓ	E2	P001	-	IBC02	-	T7	TP2	F-E, S-C	Category A. Clear of living quarters. Protected from sources of heat.	2619	
2620	AMYL BUTYRATES	3	-	III	-	5 ℓ	E1	P001 LPO1	-	IBC03	-	T2	TP1	F-E, S-D	Category A.	2620	
2621	ACETYL METHYL CARBINOL	3	-	III	-	5 ℓ	E1	P001 LPO1	-	IBC03	-	T2	TP1	F-E, S-D	Category A.	2621	
2622	GLYCIDALDEHYDE	3	6.1	II	-	1 ℓ	E2	P001	-	IBC02	B8	T7	TP1	F-E, S-D	Category A. Clear of living quarters.	2622	
2623	FIRELIGHTERS, SOLID with flammable liquid	4.1	-	III	-	5 kg	E1	P002 LPO2	PP15	-	-	-	-	F-A, S-1	Category A. "Separated from" acids.	2623	
2624	MAGNESIUM SILICIDE	4.3	-	II	-	500 g	E2	P410 PM40	PP31 PM40	IBC07	B2	T3	TP33	F-G, S-O	Category B. Only to be loaded under dry weather conditions. Under deck in a mechanically ventilated space.	2624	
2626	CHLORIC ACID, AQUEOUS SOLUTION with not more than 10% chloric acid	5.1	-	II	-	900	E2	P504	PP31	IBC02	-	-	-	F-A, S-Q	Category D. "Separated from" ammonium compounds and cyanides.	2626	
2627	NITRITES, INORGANIC, N.O.S.	5.1	-	II	-	274 300	E2	P002	-	IBC08	B2 B4	T3	TP33	F-A, S-Q	Category A. "Separated from" ammonium compounds, cyanides and sulphur.	2627	
2628	POTASSIUM FLUOROACETATE	6.1	-	I	-	0	E5	P002	-	IBC07	B1	T6	TP33	F-A, S-A	Category E.	2628	
2629	SODIUM FLUOROACETATE	6.1	-	I	-	0	E5	P002	-	IBC07	B1	T6	TP33	F-A, S-A	Category E.	2629	
2630	SELENATES or SELENITES	6.1	-	I	-	274	0	E5	P002	-	IBC07	B1	T6	TP33	F-A, S-A	Category E.	2630
2642	FLUOROACETIC ACID	6.1	-	I	-	0	E5	P002	-	IBC07	B1	T6	TP33	F-A, S-A	Category E.	2642	
2643	METHYL BROMOACETATE	6.1	-	II	-	100 ml <sup>l</sup>	E4	P001	-	IBC02	-	T7	TP2	F-A, S-A	Category D. Clear of living quarters.	2643	
2644	METHYL IODIDE	6.1	-	I	-	354	0	E0	P602	-	-	T20 TP13 TP37	TP2	F-A, S-A	Category D. Keep as cool as reasonably practicable. Clear of living quarters.	2644	
2645	PHENACYL IODIDE	6.1	-	II	-	500 g	E4	P002	-	IBC08	B2 B4	T3	TP33	F-A, S-A	Category B. Clear of living quarters.	2645	



UN No. (1)	PSN (2)	Class No. (3)	Subsidiary Risk(s) (4)	Packing Group (5)	Special Provisions (6)	Limited quantities (7a)	Excepted quantities (7b)	Packing		IBC		Portable tanks and bulk containers		Ems (15)	Stowage and Segregation (16)	Properties and Observations (17)	UN No. (18)
								Class (8)	Subsidiary Risk(s) (9)	Institutions (10)	Provisions (11)	Tank instructions (12)	Provisions (13)				
2646	HEXACHLOROCYCLOPENTADIENE	6.1	-	I	354	0	E0	P602	-	-	-	T20 TP2 TP3 TP5	F-A, S-A	Category D. Clear of living quarters.	Pale yellow liquid with a pungent odour. Immiscible with water. Causes tears, highly toxic if swallowed, by skin contact or by inhalation.	2646	
2647	MALONONITRILE	6.1	-	II	-	500 g	E4	P002	-	IBC08 B2 B4	TP33	F-A, S-A	Category A. Keep as cool as reasonably practicable.	Colourless crystals. Melting point: 32°C. Soluble in water. When heated, evolves highly toxic cyanogen fumes. Toxic if swallowed, by skin contact or by dust inhalation.	2647		
2648	1,2-DIBROMOBUTAN-3-ONE	6.1	-	II	-	100 ml	E4	P001	-	IBC02	-	-	F-A, S-A	Category B. Clear of living quarters.	Liquid, immiscible with water. Toxic if swallowed, by skin contact or by inhalation. Causes tears.	2648	
2649	1,3-DICHLOROACETONE	6.1	-	II	-	500 g	E4	P002	-	IBC08 B2 B4	TP33	F-A, S-A	Category B. Keep as cool as reasonably practicable. Clear of living quarters.	Crystals. Melting point: -45°C. Soluble in water. Decomposes when heated, evolves highly toxic fumes. Toxic if swallowed, by skin contact or by dust inhalation. Causes tears.	2649		
2650	1,1-DICHLORO-1-NITROETHANE	6.1	-	II	-	100 ml	E4	P001	-	IBC02	-	T7	F-A, S-A	Category A. Keep as cool as reasonably practicable. Clear of living quarters. "Separated from" class 5.1.	Liquid. Immiscible with water. May react vigorously with oxidizing agents. Evolves highly toxic fumes (oxides of nitrogen). Toxic if swallowed, by skin contact or by inhalation.	2650	
2651	4,4'-DIAMINODIPHENYL METHANE	6.1	P	III	-	5 kg	E1	P002 LP02	-	IBC08 B3	TP33	F-A, S-A	Category A.	Tan-coloured flakes or lumps. Slightly soluble in water. Decomposes when heated, evolving highly toxic fumes. Toxic if swallowed, by skin contact or by dust inhalation. May be carried in the molten state.	2651		
2653	BENZYL IODIDE	6.1	-	II	-	100 ml	E4	P001	-	IBC02	-	T7	F-A, S-A	Category B. Keep as cool as reasonably practicable. Clear of living quarters.	Colourless crystals. Melting point: 24°C. Insoluble in water. Toxic if swallowed, by skin contact or by dust inhalation. Causes tears.	2653	
2655	POTASSIUM FLUOROSULFATE	6.1	-	III	-	5 kg	E1	P002 LP02	-	IBC08 B3	TP33	F-A, S-A	Category A. "Separated from" acids.	Solids which react with acids, evolving hydrogen fluoride and silicon dioxide. Evolves highly toxic, corrosive gases. Toxic if swallowed, by skin contact or by dust inhalation.	2655		
2656	QUINOINE	6.1	-	III	-	5 l	E1	P001 LP01	-	IBC03	-	T4	F-A, S-A	Category A. Keep as cool as reasonably practicable.	Colourless liquid with a pungent odour. Immiscible with water. When heated, evolves highly toxic fumes (oxides of nitrogen). Toxic if swallowed, by skin contact or by inhalation.	2656	
2657	SELENIUM DISULPHIDE	6.1	-	II	-	500 g	E4	P002	-	IBC08 B2 B4	TP33	F-A, S-A	Category A.	Bright red-yellow crystals with a faint odour. Insoluble in water. Toxic if swallowed, by skin contact or by inhalation.	2657		
2659	SODIUM CHLOROACETATE	6.1	-	III	-	5 kg	E1	P002 LP02	-	IBC08 B3	TP33	F-A, S-A	Category A.	White powder. Soluble in water. Toxic if swallowed, by skin contact or by dust inhalation.	2659		
2660	NITROLIDINES (MONO)	6.1	-	III	-	5 kg	E1	P002 LP02	-	IBC08 B3	TP33	F-A, S-A	Category A.	Yellow to orange-red crystalline solids. Insoluble in water. Toxic if swallowed, by skin contact or by dust inhalation.	2660		
2661	HEXACHLOROACETONE	6.1	-	III	-	5 l	E1	P001 LP01	-	IBC03	-	T4	F-A, S-A	Category B. Keep as cool as reasonably practicable. Clear of living quarters.	Colourless to yellowish liquid. Slightly miscible with water. When heated, evolves extremely toxic fumes (phosgene). Causes tears. Toxic if swallowed, by skin contact or by inhalation.	2661	
2664	DIBROMOMETHANE	6.1	-	III	-	5 l	E1	P001 LP01	-	IBC03	-	T4	F-A, S-A	Category A.	Clear, colourless liquid. Immiscible with water. Toxic if swallowed, by skin contact or by inhalation.	2664	
2667	BUTYLQUINES	6.1	-	III	-	5 l	E1	P001 LP01	-	IBC03	-	T4	F-A, S-A	Category A.	Colourless liquids. Immiscible with water. Toxic if swallowed, by skin contact or by inhalation.	2667	

**TSFS 2015:66**  
**Bilaga 1**

UN No. (1)	PSN (2)	Class No. (3)	Subsidiary Risk(s) (4)	Packing Group (5)	Special Provisions (6)	Limited quantities (7a)	Excepted quantities (7b)	Packing		IBC		Portable tanks and bulk containers		EMS (15)	Stowage and Segregation (16)	Properties and Observations (17)	UN No. (18)
								Instruc-tions (8)	Provisions (9)	Instruc-tions (10)	Provisions (11)	Tank instructions (12)	Provisions (13)				
2666	CHLORACETONITRILE	6.1	3	I	354	0	E0	P602	-	-	-	T20 TP2 TP3 TP7	F-A, S-A	Category D. Keep as cool as practicable. Clear of living quarters. "Separated from" acids.	Colourless flammable liquid with a pungent odour. Flashpoint: 50°C c.c. Boiling point: 60°C c.c. Vapour pressure: 10 kPa at 20°C. Toxic fumes of cyanide. Reacts with steam and acids, evolving toxic and flammable vapours. Highly toxic if swallowed, by skin contact or by inhalation.	2666	
2669	CHLOROCRESOLS SOLUTION	6.1	-	II	-	100 ml <sup>f</sup>	E4	P001	-	IBC02	-	T7	F-A, S-A	Category A. Keep as cool as reasonably practicable.	Solutions with a phenol-like odour. Slightly miscible with water. Decompose when heated, evolving extremely toxic fumes (phosgene). Toxic if swallowed, by skin contact or by inhalation.	2669	
2669	CHLOROCRESOLS SOLUTION	6.1	-	III	223	5 l <sup>f</sup>	E1	P001 LP01	-	IBC03	-	T7	F-A, S-A	Category A. Keep as cool as reasonably practicable.	See entry above.	2669	
2670	CYANURIC CHLORIDE	8	-	II	-	1 kg	E2	P002	-	IBC08	B2 B4	T3	F-A, S-B	Category A. Keep as cool as reasonably practicable. Clear of living quarters.	Colourless crystals with a pungent odour. Reacts with water, forming toxic cyanuric acid. Causes severe skin irritation. Causes burns to skin, eyes and mucous membranes.	2670	
2671	AMINOPYRIDINES (o-, m-, p-)	6.1	-	II	-	500 g	E4	P002	-	IBC08	B2 B4	T3	F-A, S-A	Category B. Keep as cool as reasonably practicable. Clear of living quarters. "Separated from" acids.	White powder or crystals. Melting point: 38°C to 64°C. Soluble in water. Toxic if swallowed, by skin contact or by dust inhalation.	2671	
2672	AMMONIA SOLUTION, relative density between 0,880 and 0,957 at 15°C in water with more than 10% but not more than 35% ammonia	8	-	III	-	5 l <sup>f</sup>	E1	P001 LP01	-	IBC03	B11	T7	F-A, S-B	Category A. Under acid in a pressure-reducing container. Clear of living quarters. "Separated from" acids.	Colourless liquid with a pungent odour. Corrosive to copper, nickel, zinc and tin in their alloys. Causes severe skin irritation. Not self-heating in contact with air. Reacts violently with acids. Liquid and vapour cause burns to skin, eyes and mucous membranes.	2672	
2673	2-AMINO-4-CHLOROPHENOL	6.1	-	II	-	500 g	E4	P002	-	IBC08	B2 B4	T3	F-A, S-A	Category A.	Light brown crystals. Slightly soluble in water. Toxic if swallowed, by skin contact or by dust inhalation.	2673	
2674	SODIUM FLUOROSILICATE	6.1	-	III	-	5 kg	E1	P002 LP02	-	IBC08	B3	T1	F-A, S-A	Category A. "Separated from" acids.	Solids which react with acids, evolving hydrogen fluoride and silicon tetrafluoride, irritating and corrosive gases. Toxic if swallowed, by skin contact or by dust inhalation.	2674	
2676	STIBINE	2.3	2.1	-	-	0	E0	P200	-	-	-	-	F-D, S-U	Category D. Clear of living quarters.	Flammable, toxic, colourless gas with a foul odour. Decomposes violently in the presence of water. Much heavier than air (4.3).	2676	
2677	RUBIDIUM HYDROXIDE SOLUTION	8	-	II	-	1 l <sup>f</sup>	E2	P001	-	IBC02	-	T7	F-A, S-B	Category A. "Away from" ammonium salts. "Separated from" acids.	Liquid. Reacts violently with acids. Reacts with ammonium salts, evolving ammonia gas. Corrosive to aluminium, zinc and tin. Causes burns to skin, eyes and mucous membranes.	2677	
2677	RUBIDIUM HYDROXIDE SOLUTION	8	-	III	223	5 l <sup>f</sup>	E1	P001 LP01	-	IBC03	-	T4	F-A, S-B	Category A. "Away from" ammonium salts. "Separated from" acids.	See entry above.	2677	
2678	RUBIDIUM HYDROXIDE	8	-	II	-	1 kg	E2	P002	-	IBC08	B2 B4	T3	F-A, S-B	Category A. "Away from" ammonium salts. "Separated from" acids.	Greyish-white solid, very hygroscopic. Reacts violently with acids. Reacts with ammonium salts, evolving ammonia gas. In the presence of moisture, corrosive to aluminium, zinc and tin. Causes burns to skin, eyes and mucous membranes.	2678	
2679	LITHIUM HYDROXIDE SOLUTION	8	-	II	-	1 l <sup>f</sup>	E2	P001	-	IBC02	-	T7	F-A, S-B	Category A. "Away from" ammonium salts. "Separated from" acids.	Colourless liquid. Reacts violently with acids. Reacts with ammonium salts, evolving ammonia gas. Corrosive to aluminium, zinc and tin. Causes burns to skin, eyes and mucous membranes.	2679	
2679	LITHIUM HYDROXIDE SOLUTION	8	-	III	223	5 l <sup>f</sup>	E1	P001 LP01	-	IBC03	-	T4	F-A, S-B	Category A. "Away from" ammonium salts. "Separated from" acids.	See entry above.	2679	
2680	LITHIUM HYDROXIDE	8	-	II	-	1 kg	E2	P002	-	IBC08	B2 B4	T3	F-A, S-B	Category A. "Separated from" acids.	Colourless crystals. Soluble in water. Reacts violently with acids. Causes burns to skin, eyes and mucous membranes.	2680	
2681	CAESIUM HYDROXIDE SOLUTION	8	-	II	-	1 l <sup>f</sup>	E2	P001	-	IBC02	-	T7	F-A, S-B	Category A. "Away from" ammonium salts. "Separated from" acids.	Colourless liquid. Reacts violently with acids. Reacts with ammonium salts, evolving ammonia gas. Corrosive to glass, aluminium, zinc and tin. Causes burns to skin, eyes and mucous membranes.	2681	

UN No. (1)	PSN (2)	Class (3)	Subsidiary Risk(s) (4)	Packing Group (5)	Special Provisions (6)	Limited quantities (7a)	Excepted quantities (7b)	Packaging		IBC	
								Instruc-tions (8)	Provisions (9)	Instruc-tions (10)	Provisions (11)
312		2.0	2.0	2.0	3.3	3.4	3.5	4.1, 4	4.1, 4		

2681 CASIUM HYDROXIDE SOLUTION 8 - III 223 5 ℓ E1 P001 LPO1 - IBC03 - 2681

See entry above.

Category A. "Away from" ammonium salts. "Separated from" acids.

2682

2682	CASIUM HYDROXIDE	8	-	II	-	1 kg	E2	P002	-	IBC08	B2 B4
------	------------------	---	---	----	---	------	----	------	---	-------	----------

Category A. "Away from" ammonium salts. "Separated from" acids.

2683

2683	AMMONIUM SULPHIDE SOLUTION	8	3/6.1	II	-	1 ℓ	E2	P001	-	IBC01	-
------	----------------------------	---	-------	----	---	-----	----	------	---	-------	---

Yellow liquid with a foul odour (of rotten eggs). When heated, evolves toxic and flammable vapours. Reacts violently with acids, hydrogen sulphide, a toxic and flammable gas. Toxic if swallowed, contact or by inhalation. Corrosive to skin, eyes and mucous membranes.

2684

2684	3-DIETHYLAMINOPIPYLAMINE	3	8	III	-	5 ℓ	E1	P001	-	IBC03	-
------	--------------------------	---	---	-----	---	-----	----	------	---	-------	---

Colourless liquid with a fishy odour. Flashpoint: 59°C o.c. Miscible with water. Irritating to skin, eyes and mucous membranes.

2685

2685	N,N-DIETHYLETHYLENEDIAMINE	8	3	II	-	1 ℓ	E2	P001	-	IBC02	-
------	----------------------------	---	---	----	---	-----	----	------	---	-------	---

Colourless, flammable liquid with a fishy odour. Flashpoint: 45°C o.c. Miscible with water. Harmful by skin contact. Irritating to eyes and mucous membranes.

2686

2686	2-DIETHYLAMINOETHANOL	8	3	II	-	1 ℓ	E2	P001	-	IBC02	-
------	-----------------------	---	---	----	---	-----	----	------	---	-------	---

Colourless liquid. Miscible with water. Reacts violently with oxidizing substances. Explosive limits: 1.88 to 28%. Flashpoint: 46°C. Causes burns to skin, eyes and mucous membranes.

2687

2687	DICYCLOHEXYLAMMONIUM NITRATE	4.1	-	III	-	5 kg	E1	P002 LP02	-	IBC08	B3
------	------------------------------	-----	---	-----	---	------	----	--------------	---	-------	----

White powder. Insoluble in water. Harmful if swallowed.

2688

2688	1-BROMO-3-CHLOROPROPANE	6.1	-	III	-	5 ℓ	E1	P001 LP01	-	IBC03	-
------	-------------------------	-----	---	-----	---	-----	----	--------------	---	-------	---

Colourless liquid. Immiscible with water. Decomposes when heated, evolving highly toxic fumes. Toxic if swallowed, by skin contact or by inhalation.

2689

2689	GLYCEROL- $\alpha$ -MONOCHLOROHYDRIN	6.1	-	III	-	5 ℓ	E1	P001 LP01	-	IBC03	-
------	--------------------------------------	-----	---	-----	---	-----	----	--------------	---	-------	---

Colourless liquid. Miscible with water. Toxic if swallowed, by skin contact or by inhalation.

2690

2690	N,N-BUTYLIMIDAZOLE	6.1	-	II	-	100 ml	E4	P001	-	IBC02	-
------	--------------------	-----	---	----	---	--------	----	------	---	-------	---

Colourless to amber mobile liquid. Miscible with water. Toxic if swallowed, by skin contact or by inhalation.

2691

2691	PHOSPHORUS PENTABROMIDE	8	-	II	-	1 kg	E2	P002	-	IBC08	B2 B4
------	-------------------------	---	---	----	---	------	----	------	---	-------	----------

Yellow hygroscopic crystals, evolving fumes in the air which are corrosive to mucous membranes. Reacts violently with water, forming phosphoric acid, phosphorous bromide, an irritating and corrosive gas apparent as white fumes. Reacts violently with ammonia, bases and many other substances and may cause fire and explosion.

2692

2692	BORON TRIBROMIDE	8	-	I	-	0	E0	P602	-	-	-
------	------------------	---	---	---	---	---	----	------	---	---	---

Colourless fuming liquid. Reacts violently with water, evolving toxic and corrosive fumes. Decomposes when heated, evolving toxic fumes. In the presence of moisture, highly corrosive to most metals. Liquid and vapour cause severe burns to skin, eyes and mucous membranes.

2693

2693	BISULPHITES, AQUEOUS SOLUTION, N.O.S.	8	-	III	-	274	5 ℓ	E1	P001 LP01	-	IBC03
------	---------------------------------------	---	---	-----	---	-----	-----	----	--------------	---	-------

Liquid with a pungent odour. Reacts with acids, evolving sulphur dioxide, a toxic gas. Causes burns to skin, eyes and mucous membranes.

2698

2698	TETRAHYDROPHTHALIC ANHYDRIDES with more than 0.05% maleic anhydride	8	-	III	-	29 169 939	E1	P002 LP02	-	IBC08	B3
------	---	---	---	-----	---	------------------	----	--------------	---	-------	----

White crystalline powders. React with water, evolving heat and forming tetrahydrophthalic acid. Cause burns to skin, eyes and mucous membranes. When heated, evolve acid fumes which are irritating to skin, eyes and mucous membranes.

2699

2699	TRIFLUOROACETIC ACID	8	-	I	-	0	E0	P001	-	-	-
------	----------------------	---	---	---	---	---	----	------	---	---	---

Colourless, fuming, hygroscopic liquid with a pungent odour. Miscible with water. When heated to decomposition or in contact with acids evolves toxic gases. In the presence of moisture, highly corrosive to most metals. Causes severe burns to skin, eyes and mucous membranes. Liquid causes severe burns to skin, eyes and mucous membranes.

UN No. (1)	PSN (2)	Class or Div (3)	Subsidiary Risk(s) (4)	Packing Group (5)	Special Provisions (6)	Limited quantities (7a)	Excepted quantities (7b)	Packing			IBC	
								Instruc-tions (8)	Instruc-tions (9)	Instruc-tions (10)	Provisions (11)	Provisions (11)
3.1.2		2.0	2.0	2.0, 1.3	3.3	3.4	3.5	4.1, 4	4.1, 4	4.1, 4		

2705 1-PENTOL	8	-	II	-	1 ℓ	E2	P001	-	IBC02	-		
2707 DIMETHYLDIOXANES	3	-	II	-	1 ℓ	E2	P001	-	IBC02	-		
2707 DIMETHYLDIOXANES	3	-	III	223	5 ℓ	E1	P001 LP01	-	IBC03	-		
2709 BUTYLBENZENES	3	-	III	-	5 ℓ	E1	P001 LP01	-	IBC03	-		
2710 DIPROPYL KETONE	3	-	III	-	5 ℓ	E1	P001 LP01	-	IBC03	-		
2713 ACRIDINE	6.1	-	III	-	5 kg	E1	P002 LP02	-	IBC08	B3		
2714 ZINC RESINATE	4.1	-	III	-	5 kg	E1	P002	-	IBC06	-		
2715 ALUMINIUM RESINATE	4.1	-	III	-	5 kg	E1	P002	-	IBC06	-		
2716 1,4-BUTYNYDIOL	6.1	-	III	-	5 kg	E1	P002 LP02	-	IBC08	B3		
2717 CAMPHOR, synthetic	4.1	-	III	-	5 kg	E1	P002 LP02	-	IBC08	B3		
2719 BARIUM BROMATE	5.1	6.1	II	-	1 kg	E2	P002	-	IBC08	B2 B4		
2720 CHROMIUM NITRATE	5.1	-	III	-	5 kg	E1	P002 LP02	-	IBC08	B3		
2721 COPPER CHLORATE	5.1	-	II	-	1 kg	E2	P002	-	IBC08	B2 B4		
2722 LITHIUM NITRATE	5.1	-	III	-	5 kg	E1	P002 LP02	-	IBC08	B3		

# TSFS 2015:66 Bilaga 1

UN No. (16)	Properties and Observations (17)	Portable tanks and bulk containers		Stowage and Segregation (16)	Properties and Observations (17)
		Tank instructions (15)	Provisions (14)		
		4.2.5 4.3	4.2.5	5.4.3.2 7.8	
2705	Colourless liquid with a perceptible odour. May react in contact with acids and alkalis. Causes burns to skin, eyes and mucous membranes.	T7	TP2	F-A, S-B Category B. "Away from" acids and alkalis.	2705
2707	Colourless liquids with a pungent odour. Partially miscible with water. React vigorously with oxidizing substances. Harmful by inhalation. Irritating to skin, eyes and mucous membranes.	T4	TP1	F-E, S-D Category B.	2707
2707	See entry above.	T2	TP1	F-E, S-D Category A.	2707
2709	Colourless liquids with an unpleasant odour. Flashpoint: 34C to 60°C c. Explosive limits: 0.7% to 6.9%. Immiscible with water. Irritating to skin, eyes and mucous membranes.	T2	TP1	F-E, S-D Category A.	2709
2710	Colourless liquid. Flashpoint: 49°C c. Immiscible with water.	T2	TP1	F-E, S-D Category A.	2710
2713	Small colourless to yellowish crystals or needles. Sublimes at 100°C. Practically insoluble in water. Toxic if swallowed, by skin contact or by inhalation.	T1	TP33	F-A, S-A Category A.	2713
2714	Powder or clear amber lumps. Insoluble in water. Liable to spontaneous heating. Irritating to skin and mucous membranes.	T1	TP33	F-A, S-1 Category A.	2714
2715	Cream to brown coloured mass. Insoluble in water. Liable to spontaneous heating. Irritating to skin and mucous membranes.	T1	TP33	F-A, S-1 Category A.	2715
2716	White crystals. Melting point: 55°C. Soluble in water. Forms explosive mixtures with mercury salts, strong acids, alkaline compounds and halides. Toxic if swallowed, by skin contact or by inhalation.	T1	TP33	F-A, S-A Category A. "Separated from" acids, alkalis and mercury salts.	2716
2717	Colourless or white crystals, granules or easily broken masses with a penetrating, pungent and aromatic odour. Slightly soluble in water. When heated, evolves flammable and explosive vapours. Harmful if swallowed.	T1	TP33	F-A, S-1 Category A.	2717
2719	White crystals or powder. Slightly soluble in water. Reacts vigorously with sulphuric acid. Reacts fiercely with cyanides when heated or by friction. May form explosive mixtures with combustible materials, peroxides and metals or form toxic mixtures with cyanides. These mixtures are highly sensitive and are liable to ignite. When involved in a fire may cause an explosion. Toxic if swallowed, by skin contact or by dust inhalation.	T3	TP33	F-H, S-Q Category A. "Separated from" ammonium compounds and cyanides.	2719
2720	Purple crystals. Mixtures with combustible material are readily ignited and may burn fiercely. Solutions in water are slightly corrosive. Harmful if swallowed.	T1	TP33	F-A, S-Q Category A.	2720
2721	Blue-green deliquescent crystals or powder. Soluble in water. Reacts vigorously with sulphuric acid. Reacts fiercely with cyanides when heated or by friction. May form explosive mixtures with combustible material. May form toxic mixtures with cyanides. These mixtures are highly sensitive to friction and are liable to ignite. When involved in a fire may cause an explosion.	T3	TP33	F-H, S-Q Category A. "Separated from" ammonium compounds and cyanides.	2721
2722	Colourless deliquescent crystals. Soluble in water. Mixtures with combustible material are readily ignited and burn fiercely. Harmful if swallowed.	T1	TP33	F-A, S-Q Category A.	2722

UN No. (1)	PSN (2)	Class or Div (3)	Subsidiary Risk(s) (4)	Packing Group (5)	Special Provisions (6)	Limited quantities (7a)	Excepted quantities (7b)	Packing			Portable tanks and bulk containers			Properties and Observations (17)	UN No. (18)		
								Class or Div (5)	Special Provisions (6)	Instruc-tions (8)	Instruc-tions (9)	Instruc-tions (10)	Provisions (11)			Tank instructions (15)	Provisions (14)
	3.1.2	2.0	2.0	2.0, 1.3	3.3	3.4	3.5	4.1, 4	4.1, 4	4.1, 4	4.3	4.2, 5	4.2, 5	54, 5.2	7.1 to 7.7		
2723	MAGNESIUM CHLORATE	5.1	-	II	-	1 kg	E2	P002	-	IBC08	B2, B4	T3	TP33	F-H, S-Q	Category A. "Separated from" ammonium compounds and cyanides.	White deliquescent crystals or powder. Soluble in water. Melting point: Reacts vigorously with sulphuric acid. Reacts fiercely with cyanides when heated or by friction. May form explosive mixtures with combustible material, powdered metals or ammonium compounds. These mixtures are sensitive to friction and are liable to ignite. When involved in a fire, they may cause a violent reaction. When involved in a fire, they should be kept cool from the start to and after loading. If weather is inclement, hatches should be closed.	2723
2724	MANGANESE NITRATE	5.1	-	III	-	5 kg	E1	P002, UPO2	-	IBC08	B3	T1	TP33	F-A, S-Q	Category A.	Pale pink, deliquescent crystals. Soluble in water. Melting point between 26°C and 35°C. Mixtures with combustible material are readily ignited and may burn fiercely. Solutions in water are slightly corrosive. Harmful if swallowed.	2724
2725	NICKEL NITRATE	5.1	-	III	-	5 kg	E1	P002, UPO2	-	IBC08	B3	T1	TP33	F-A, S-Q	Category A.	Green deliquescent crystals. Soluble in water. Melting point: 53°C. Mixtures with combustible material are readily ignited and may burn fiercely. Solutions in water are slightly corrosive. Harmful if swallowed.	2725
2726	NICKEL NITRITE	5.1	-	III	-	5 kg	E1	P002, UPO2	-	IBC08	B3	T1	TP33	F-A, S-Q	Category A. "Separated from" ammonium compounds and cyanides.	Reddish-yellow crystals. Decomposes if heated, giving off toxic nitrous fumes. Mixtures with combustible material are readily ignited and may burn fiercely. Mixtures with ammonium compounds or cyanides may explode. Harmful if swallowed.	2726
2727	THALLIUM NITRATE	6.1	5.1/P	II	-	500 g	E4	P002	-	IBC06	B2	T3	TP33	F-A, S-Q	Category A.	Colourless crystals. Soluble in water. Mixtures with combustible material are readily ignited and may burn fiercely. Toxic if swallowed, by skin contact or by dust inhalation.	2727
2728	ZIRCONIUM NITRATE	5.1	-	III	-	5 kg	E1	P002, UPO2	-	IBC08	B3	T1	TP33	F-A, S-Q	Category A.	White crystals, flakes or powder. Soluble in water. Solutions in water are slightly corrosive. Harmful if swallowed.	2728
2729	HEXACHLOROBENZENE	6.1	-	III	-	5 kg	E1	P002, UPO2	-	IBC08	B3	T1	TP33	F-A, S-A	Category A.	White needle-like crystals. Insoluble in water. Decomposes when heated, evolving highly toxic fumes. Toxic if swallowed, by skin contact or by dust inhalation.	2729
2730	NITROANISOLE, LIQUID	6.1	-	III	279	5 ℓ	E1	P001, UPO1	-	IBC03	-	T4	TP1	F-A, S-A	Category A.	Light reddish or amber liquid. Immiscible with water. Toxic if swallowed, by skin contact or by inhalation.	2730
2732	NITROBROMOBENZENE, LIQUID	6.1	-	III	-	5 ℓ	E1	P001, UPO1	-	IBC03	-	T4	TP1	F-A, S-A	Category A.	Colourless to pale yellow liquids. Melting point of 1-BROMO-3-NITROBENZENE: 17°C. Immiscible with water. Toxic if swallowed, by skin contact or by inhalation.	2732
2733	AMINES, FLAMMABLE, CORROSIVE, N.O.S. or POLYAMINES, FLAMMABLE, CORROSIVE, N.O.S.	3	8	I	274	0	E0	P001	-	-	-	T14	TP1, TP27	F-E, S-C	Category D. Clear of living quarters. "Separated from" acids.	Colourless to yellowish liquids with an unpleasant odour. Some are very volatile. Miscible with water. Corrosive to most metals, especially to copper and its alloys. When involved in a fire, evolve toxic gases. Reacts violently with acids. Harmful by inhalation. Cause burns to skin, eyes and mucous membranes.	2733
2733	AMINES, FLAMMABLE, CORROSIVE, N.O.S. or POLYAMINES, FLAMMABLE, CORROSIVE, N.O.S.	3	8	II	274	1 ℓ	E2	P001	-	IBC02	-	T11	TP1, TP27	F-E, S-C	Category B. Clear of living quarters. See entry above.	See entry above.	2733
2733	AMINES, FLAMMABLE, CORROSIVE, N.O.S. or POLYAMINES, FLAMMABLE, CORROSIVE, N.O.S.	3	8	III	274	5 ℓ	E1	P001	-	IBC03	-	T7	TP1, TP28	F-E, S-C	Category A. Clear of living quarters. See entry above.	See entry above.	2733
2734	AMINES, LIQUID, CORROSIVE, FLAMMABLE, N.O.S. or POLYAMINES, LIQUID, CORROSIVE, FLAMMABLE, N.O.S.	8	3	I	274	0	E0	P001	-	-	-	T14	TP2, TP27	F-E, S-C	Category A. "Separated from" acids.	Colourless to yellowish flammable liquids or solutions with a pungent odour. Miscible with water. When involved in a fire, evolve toxic gases. Corrosive to most metals, especially to copper and its alloys. Reacts violently with acids. Cause burns to skin, eyes and mucous membranes.	2734
2734	AMINES, LIQUID, CORROSIVE, FLAMMABLE, N.O.S. or POLYAMINES, LIQUID, CORROSIVE, FLAMMABLE, N.O.S.	8	3	II	274	1 ℓ	E2	P001	-	IBC02	-	T11	TP2, TP27	F-E, S-C	Category A. "Separated from" acids.	See entry above.	2734

UN No. (1)	PSN (2)	Class No. or Div. (5)	Subsidiary Risk(s) (4)	Packing Group (3)	Special Provisions (6)	Limited quantities (7a)	Excepted quantities (7b)	Packing		IBC	
								Instruc-tions (8)	Provisions (9)	Instruc-tions (10)	Provisions (11)
3.1.2		2.0	2.0	2.0, 1.3	3.3	3.4	3.5	4.1, 4	4.1, 4	4.1, 4	

2735 AMINES, LIQUID, CORROSIVE, N.O.S. or POLYAMINES, LIQUID, CORROSIVE, N.O.S.

UN No. (16)	Properties and Observations (17)
(17)	

2735 AMINES, LIQUID, CORROSIVE, N.O.S. or POLYAMINES, LIQUID, CORROSIVE, N.O.S.

2735 AMINES, LIQUID, CORROSIVE, N.O.S. or POLYAMINES, LIQUID, CORROSIVE, N.O.S.

2735 AMINES, LIQUID, CORROSIVE, N.O.S. or POLYAMINES, LIQUID, CORROSIVE, N.O.S.

2735 AMINES, LIQUID, CORROSIVE, N.O.S. or POLYAMINES, LIQUID, CORROSIVE, N.O.S.

2738 n-BUTYLANILINE

2739 BUTYRIC ANHYDRIDE

2740 n-PROPYL CHLOROFORMATE

2741 BARIUM HYPOCHLORITE with more than 22% available chlorine

2742 CHLOROFORMATES, TOXIC, CORROSIVE, FLAMMABLE, N.O.S.

2743 n-BUTYL CHLOROFORMATE

2744 CYCLOBUTYL CHLOROFORMATE

2745 CHLOROMETHYL CHLOROFORMATE

2746 PHENYL CHLOROFORMATE

2747 tert-BUTYLCYCLOHEXYL CHLOROFORMATE

UN No. (16)	Properties and Observations (17)

2735 AMINES, LIQUID, CORROSIVE, N.O.S. or POLYAMINES, LIQUID, CORROSIVE, N.O.S.

2735 AMINES, LIQUID, CORROSIVE, N.O.S. or POLYAMINES, LIQUID, CORROSIVE, N.O.S.

2735 AMINES, LIQUID, CORROSIVE, N.O.S. or POLYAMINES, LIQUID, CORROSIVE, N.O.S.

2735 AMINES, LIQUID, CORROSIVE, N.O.S. or POLYAMINES, LIQUID, CORROSIVE, N.O.S.

2738 n-BUTYLANILINE

2739 BUTYRIC ANHYDRIDE

2740 n-PROPYL CHLOROFORMATE

2741 BARIUM HYPOCHLORITE with more than 22% available chlorine

2742 CHLOROFORMATES, TOXIC, CORROSIVE, FLAMMABLE, N.O.S.

2743 n-BUTYL CHLOROFORMATE

2744 CYCLOBUTYL CHLOROFORMATE

2745 CHLOROMETHYL CHLOROFORMATE

2746 PHENYL CHLOROFORMATE

2747 tert-BUTYLCYCLOHEXYL CHLOROFORMATE

2741 BARIUM HYPOCHLORITE with more than 22% available chlorine

2742 CHLOROFORMATES, TOXIC, CORROSIVE, FLAMMABLE, N.O.S.

2743 n-BUTYL CHLOROFORMATE

2744 CYCLOBUTYL CHLOROFORMATE

2745 CHLOROMETHYL CHLOROFORMATE

2746 PHENYL CHLOROFORMATE

2747 tert-BUTYLCYCLOHEXYL CHLOROFORMATE

2744 CYCLOBUTYL CHLOROFORMATE

2745 CHLOROMETHYL CHLOROFORMATE

2746 PHENYL CHLOROFORMATE

2747 tert-BUTYLCYCLOHEXYL CHLOROFORMATE

2744 CYCLOBUTYL CHLOROFORMATE

2745 CHLOROMETHYL CHLOROFORMATE

2746 PHENYL CHLOROFORMATE

2747 tert-BUTYLCYCLOHEXYL CHLOROFORMATE

2744 CYCLOBUTYL CHLOROFORMATE

2745 CHLOROMETHYL CHLOROFORMATE

2746 PHENYL CHLOROFORMATE

2747 tert-BUTYLCYCLOHEXYL CHLOROFORMATE

2744 CYCLOBUTYL CHLOROFORMATE

2745 CHLOROMETHYL CHLOROFORMATE

2746 PHENYL CHLOROFORMATE

2747 tert-BUTYLCYCLOHEXYL CHLOROFORMATE

UN No. (1)	PSN (2)	Class (3)	Subsidiary Risk(s) (4)	Packing Group (5)	Special Provisions (6)	Limited quantities (7a)	Excepted quantities (7b)	Packing			IBC			
								Class (3)	Subsidiary Risk(s) (4)	Packing Group (5)	Special Provisions (6)	Limited quantities (7a)	Excepted quantities (7b)	Institutions (10)
3.1.2		2.0	2.0	2.0, 1.3	3.3	3.4	3.5	4.1, 4	4.1, 4	4.1, 4				
2748	2-ETHYLHEXYL CHLORFORMATE	6.1	8	II	-	100 mf	E4	P001	-	IBC02	-	-	-	2748
2749	TETRAMETHYLSILANE	3	-	I	-	0	E3	P001	-	-	-	-	-	2749
2750	1,3-DICHLOROPROPANOL-2	6.1	-	II	-	100 mf	E4	P001	-	IBC02	-	-	-	2750
2751	DIETHYLTHIOPHOSPHORYL CHLORIDE	8	-	II	-	1 ℓ	E2	P001	-	IBC02	-	-	-	2751
2752	1,2-EPOXY-3-ETHOXYPROPANE	3	-	III	-	5 ℓ	E1	P001 LP01	-	IBC03	-	-	-	2752
2753	N-ETHYLBENZYL OULIDINES, LIQUID	6.1	-	III	-	5 ℓ	E1	P001 LP01	-	IBC03	-	-	-	2753
2754	N-ETHYLOULIDINES	6.1	-	II	-	100 mf	E4	P001	-	IBC02	-	-	-	2754
2757	CARBAMATE PESTICIDE, SOLID, TOXIC	6.1	-	I	61 274	0	E5	P002	-	IBC07	B1	-	-	2757
2757	CARBAMATE PESTICIDE, SOLID, TOXIC	6.1	-	II	61 274	500 g	E4	P002	-	IBC08	B2 B4	-	-	2757
2757	CARBAMATE PESTICIDE, SOLID, TOXIC	6.1	-	III	61 223 274	5 kg	E1	P002 LP02	-	IBC08	B3	-	-	2757
2758	CARBAMATE PESTICIDE, LIQUID, FLAMMABLE, TOXIC, flashpoint less than 23°C	3	6.1	I	61 274	0	ED	P001	-	-	-	-	-	2758
2758	CARBAMATE PESTICIDE, LIQUID, FLAMMABLE, TOXIC, flashpoint less than 23°C	3	6.1	II	61 274	1 ℓ	E2	P001	-	IBC02	-	-	-	2758
2759	ARSENICAL PESTICIDE, SOLID, TOXIC	6.1	-	I	61 274	0	E5	P002	-	IBC07	B1	-	-	2759
2759	ARSENICAL PESTICIDE, SOLID, TOXIC	6.1	-	II	61 274	500 g	E4	P002	-	IBC08	B2 B4	-	-	2759
2759	ARSENICAL PESTICIDE, SOLID, TOXIC	6.1	-	III	61 223 274	5 kg	E1	P002 LP02	-	IBC08	B3	-	-	2759

UN No. (1)	PSN (2)	Class or Div. (3)	Subsidiary Risk(s) (4)	Packing Group (5)	Special Provisions (6)	Limited quantities (7a)	Excepted quantities (7b)	Packing		IBC	
								Instruc-tions (8)	Provisions (9)	Instruc-tions (10)	Provisions (11)
	3.1.2	2.0	2.0	2.0, 1.3	3.3	3.4	3.5	4.1, 4	4.1, 4	4.1, 4	

2760 ARSENICAL PESTICIDE, LIQUID, FLAMMABLE, TOXIC, flashpoint less than 23 °C

2760 ARSENICAL PESTICIDE, LIQUID, FLAMMABLE, TOXIC, flashpoint less than 23 °C

2761 ORGANOCHLORINE PESTICIDE, SOLID, TOXIC

2761 ORGANOCHLORINE PESTICIDE, SOLID, TOXIC

2761 ORGANOCHLORINE PESTICIDE, SOLID, TOXIC

2762 ORGANOCHLORINE PESTICIDE, LIQUID, FLAMMABLE, TOXIC, flashpoint less than 23 °C

2762 ORGANOCHLORINE PESTICIDE, LIQUID, FLAMMABLE, TOXIC, flashpoint less than 23 °C

2763 TRIAZINE PESTICIDE, SOLID, TOXIC

2763 TRIAZINE PESTICIDE, SOLID, TOXIC

2763 TRIAZINE PESTICIDE, SOLID, TOXIC

2764 TRIAZINE PESTICIDE, LIQUID, FLAMMABLE, TOXIC, flashpoint less than 23 °C

2764 TRIAZINE PESTICIDE, LIQUID, FLAMMABLE, TOXIC, flashpoint less than 23 °C

2771 THIOCARBAMATE PESTICIDE, SOLID, TOXIC

2771 THIOCARBAMATE PESTICIDE, SOLID, TOXIC

UN No. (1)	PSN (2)	Class or Div. (3)	Subsidiary Risk(s) (4)	Packing Group (5)	Special Provisions (6)	Limited quantities (7a)	Excepted quantities (7b)	Packing		IBC	
								Instruc-tions (8)	Provisions (9)	Instruc-tions (10)	Provisions (11)
	3.1.2	2.0	2.0	2.0, 1.3	3.3	3.4	3.5	4.1, 4	4.1, 4	4.1, 4	

2760 ARSENICAL PESTICIDE, LIQUID, FLAMMABLE, TOXIC, flashpoint less than 23 °C

2760 ARSENICAL PESTICIDE, LIQUID, FLAMMABLE, TOXIC, flashpoint less than 23 °C

2761 ORGANOCHLORINE PESTICIDE, SOLID, TOXIC

2761 ORGANOCHLORINE PESTICIDE, SOLID, TOXIC

2761 ORGANOCHLORINE PESTICIDE, SOLID, TOXIC

2762 ORGANOCHLORINE PESTICIDE, LIQUID, FLAMMABLE, TOXIC, flashpoint less than 23 °C

2762 ORGANOCHLORINE PESTICIDE, LIQUID, FLAMMABLE, TOXIC, flashpoint less than 23 °C

2763 TRIAZINE PESTICIDE, SOLID, TOXIC

2763 TRIAZINE PESTICIDE, SOLID, TOXIC

2763 TRIAZINE PESTICIDE, SOLID, TOXIC

2764 TRIAZINE PESTICIDE, LIQUID, FLAMMABLE, TOXIC, flashpoint less than 23 °C

2764 TRIAZINE PESTICIDE, LIQUID, FLAMMABLE, TOXIC, flashpoint less than 23 °C

2771 THIOCARBAMATE PESTICIDE, SOLID, TOXIC

2771 THIOCARBAMATE PESTICIDE, SOLID, TOXIC

2760 ARSENICAL PESTICIDE, LIQUID, FLAMMABLE, TOXIC, flashpoint less than 23 °C

2760 ARSENICAL PESTICIDE, LIQUID, FLAMMABLE, TOXIC, flashpoint less than 23 °C

2761 ORGANOCHLORINE PESTICIDE, SOLID, TOXIC

2761 ORGANOCHLORINE PESTICIDE, SOLID, TOXIC

2761 ORGANOCHLORINE PESTICIDE, SOLID, TOXIC

2762 ORGANOCHLORINE PESTICIDE, LIQUID, FLAMMABLE, TOXIC, flashpoint less than 23 °C

2762 ORGANOCHLORINE PESTICIDE, LIQUID, FLAMMABLE, TOXIC, flashpoint less than 23 °C

2763 TRIAZINE PESTICIDE, SOLID, TOXIC

2763 TRIAZINE PESTICIDE, SOLID, TOXIC

2763 TRIAZINE PESTICIDE, SOLID, TOXIC

2764 TRIAZINE PESTICIDE, LIQUID, FLAMMABLE, TOXIC, flashpoint less than 23 °C

2764 TRIAZINE PESTICIDE, LIQUID, FLAMMABLE, TOXIC, flashpoint less than 23 °C

2771 THIOCARBAMATE PESTICIDE, SOLID, TOXIC

2771 THIOCARBAMATE PESTICIDE, SOLID, TOXIC



UN No. (1)	PSN (2)	Class or Div (5)	Subsidiary Risk(s) (4)	Packing (3)	Special Provisions (6)	Limited quantities (7a)	Excepted quantities (7b)	Packing		IBC		UN No. (18)
								Instruc-tions (8)	Provisions (9)	Instruc-tions (10)	Provisions (11)	
	3.1.2	2.0	2.0	2.0.1.3	3.3	3.4	3.5	4.1.4	4.1.4	4.1.4	4.1.4	
2771	THIOCARBAMATE PESTICIDE, SOLID, TOXIC	6.1	-	III	61 223 274	5 kg	E1	P002 LPO2	-	IBC08	B3	2771
2772	THIOCARBAMATE PESTICIDE, LIQUID, FLAMMABLE, TOXIC, flashpoint less than 23°C	3	6.1	I	61 274	0	E0	P001	-	-	-	2772
2772	THIOCARBAMATE PESTICIDE, LIQUID, FLAMMABLE, TOXIC, flashpoint less than 23°C	3	6.1	II	61 274	1 ℓ	E2	P001	-	IBC02	-	2772
2775	COPPER BASED PESTICIDE, SOLID, TOXIC	6.1	-	I	61 274	0	E5	P002	-	IBC07	B1	2775
2775	COPPER BASED PESTICIDE, SOLID, TOXIC	6.1	-	II	61 274	500 g	E4	P002	-	IBC08	B2 B4	2775
2775	COPPER BASED PESTICIDE, SOLID, TOXIC	6.1	-	III	61 223 274	5 kg	E1	P002 LPO2	-	IBC08	B3	2775
2776	COPPER BASED PESTICIDE, LIQUID, FLAMMABLE, TOXIC, flashpoint less than 23°C	3	6.1	I	61 274	0	E0	P001	-	-	-	2776
2776	COPPER BASED PESTICIDE, LIQUID, FLAMMABLE, TOXIC, flashpoint less than 23°C	3	6.1	II	61 274	1 ℓ	E2	P001	-	IBC02	-	2776
2777	MERCURY BASED PESTICIDE, SOLID, TOXIC	6.1	-	I	61 274	0	E5	P002	-	IBC07	B1	2777
2777	MERCURY BASED PESTICIDE, SOLID, TOXIC	6.1	-	II	61 274	500 g	E4	P002	-	IBC08	B2 B4	2777
2777	MERCURY BASED PESTICIDE, SOLID, TOXIC	6.1	-	III	61 223 274	5 kg	E1	P002 LPO2	-	IBC08	B3	2777
2778	MERCURY BASED PESTICIDE, LIQUID, FLAMMABLE, TOXIC, flashpoint less than 23°C	3	6.1	I	61 274	0	E0	P001	-	-	-	2778
2778	MERCURY BASED PESTICIDE, LIQUID, FLAMMABLE, TOXIC, flashpoint less than 23°C	3	6.1	P	61 274	0	E0	P001	-	-	-	2778
2778	MERCURY BASED PESTICIDE, LIQUID, FLAMMABLE, TOXIC, flashpoint less than 23°C	3	6.1	II	61 274	1 ℓ	E2	P001	-	IBC02	-	2778
2779	SUBSTITUTED NITROPHENOL PESTICIDE, SOLID, TOXIC	6.1	-	I	61 274	0	E5	P002	-	IBC07	B1	2779

**TSFS 2015:66  
Bilaga 1**

UN No. (1)	PSN (2)	Class or Div (3)	Subsidiary Risk(s) (4)	Packing Group (5)	Special Provisions (6)	Limited quantities (7a)	Excepted quantities (7b)	Packing			IBCs
								Instruc-tions (8)	Provisions (9)	Instruc-tions (10)	
3.1.2		2.0	2.0	2.0, 1.3	3.3	3.4	3.5	4.1, 4	4.1, 4	4.1, 4	
		6.1	-	II	61	500 g	E4	P002	-	IBC08	B2 B4

2779 SUBSTITUTED NITROPHENOL PESTICIDE, SOLID, TOXIC 6.1 - II 61 500 g E4 P002 - IBC08 B2 B4 2779

2779 SUBSTITUTED NITROPHENOL PESTICIDE, SOLID, TOXIC 6.1 - III 61 5 kg E1 P002, LPO2 - IBC08 B3 2779

2780 SUBSTITUTED NITROPHENOL PESTICIDE, LIQUID, FLAMMABLE, TOXIC, flashpoint less than 23°C 3 6.1 I 61 0 E0 P001 - - - - - T14 TP2 TP3 TP27 F-E, S-D Category B. Clear of living quarters. Pesticides frequently contain petroleum or coal tar distillates, or other flammable liquids. Miscibility with water depends upon the composition. Toxic if swallowed, by skin contact or by inhalation. 2780

2780 SUBSTITUTED NITROPHENOL PESTICIDE, LIQUID, FLAMMABLE, TOXIC, flashpoint less than 23°C 3 6.1 II 61 1 l E2 P001 - IBC02 - - - - - T11 TP2 TP3 TP27 F-E, S-D Category B. Clear of living quarters. See entry above. 2780

2781 BIPYRIDILIUM PESTICIDE, SOLID, TOXIC 6.1 - I 61 274 0 E5 P002 - IBC07 B1 2781

2781 BIPYRIDILIUM PESTICIDE, SOLID, TOXIC 6.1 - II 61 500 g E4 P002 - IBC08 B2 B4 2781

2781 BIPYRIDILIUM PESTICIDE, SOLID, TOXIC 6.1 - III 61 5 kg E1 P002, LPO2 - IBC08 B3 2781

2782 BIPYRIDILIUM PESTICIDE, LIQUID, FLAMMABLE, TOXIC, flashpoint less than 23°C 3 6.1 I 61 0 E0 P001 - - - - - T14 TP2 TP3 TP27 F-E, S-D Category B. Clear of living quarters. Pesticides frequently contain petroleum or coal tar distillates, or other flammable liquids. Miscibility with water depends upon the composition. Toxic if swallowed, by skin contact or by inhalation. 2782

2782 BIPYRIDILIUM PESTICIDE, LIQUID, FLAMMABLE, TOXIC, flashpoint less than 23°C 3 6.1 II 61 1 l E2 P001 - IBC02 - - - - - T11 TP2 TP3 TP27 F-E, S-D Category B. Clear of living quarters. See entry above. 2782

2783 ORGANOPHOSPHORUS PESTICIDE, SOLID, TOXIC 6.1 - I 61 274 0 E5 P002 - IBC07 B1 2783

2783 ORGANOPHOSPHORUS PESTICIDE, SOLID, TOXIC 6.1 - II 61 500 g E4 P002 - IBC08 B2 B4 2783

2783 ORGANOPHOSPHORUS PESTICIDE, SOLID, TOXIC 6.1 - III 61 5 kg E1 P002, LPO2 - IBC08 B3 2783

2784 ORGANOPHOSPHORUS PESTICIDE, LIQUID, FLAMMABLE, TOXIC, flashpoint less than 23°C 3 6.1 I 61 0 E0 P001 - - - - - T14 TP2 TP3 TP27 F-E, S-D Category B. Clear of living quarters. Pesticides frequently contain petroleum or coal tar distillates, or other flammable liquids. Miscibility with water depends upon the composition. Toxic if swallowed, by skin contact or by inhalation. 2784

2784 ORGANOPHOSPHORUS PESTICIDE, LIQUID, FLAMMABLE, TOXIC, flashpoint less than 23°C 3 6.1 II 61 1 l E2 P001 - IBC02 - - - - - T11 TP2 TP3 TP27 F-E, S-D Category B. Clear of living quarters. See entry above. 2784

UN No. (1)	PSN (2)	Class or Div (3)	Subsidiary Risk(s) (4)	Packing Group (5)	Special Provisions (6)	Limited quantities (7a)	Excepted quantities (7b)	Packing			IBCs
								Instruc-tions (8)	Provisions (9)	Instruc-tions (10)	
4.2.5		2.0	2.0	2.0, 1.3	3.3	3.4	3.5	4.1, 4	4.1, 4	4.1, 4	
4.3		6.1	-	II	61	500 g	E4	P002	-	IBC08	B2 B4

T3 TP33 F-A, S-A Category A. Clear of living quarters. See entry above. 2779

T1 TP33 F-A, S-A Category A. Clear of living quarters. See entry above. 2779

T14 TP2 TP3 TP27 F-E, S-D Category B. Clear of living quarters. Pesticides frequently contain petroleum or coal tar distillates, or other flammable liquids. Miscibility with water depends upon the composition. Toxic if swallowed, by skin contact or by inhalation. 2780

T11 TP2 TP3 TP27 F-E, S-D Category B. Clear of living quarters. See entry above. 2780

T6 TP33 F-A, S-A Category A. Clear of living quarters. Solid pesticides present a very wide range of toxic hazard. Toxic if swallowed, by skin contact or by inhalation. 2781

T3 TP33 F-A, S-A Category A. Clear of living quarters. See entry above. 2781

T1 TP33 F-A, S-A Category A. Clear of living quarters. See entry above. 2781

T14 TP2 TP3 TP27 F-E, S-D Category B. Clear of living quarters. Pesticides frequently contain petroleum or coal tar distillates, or other flammable liquids. Miscibility with water depends upon the composition. Toxic if swallowed, by skin contact or by inhalation. 2782

T11 TP2 TP3 TP27 F-E, S-D Category B. Clear of living quarters. See entry above. 2782

T6 TP33 F-A, S-A Category A. Clear of living quarters. Solid pesticides present a very wide range of toxic hazard. Toxic if swallowed, by skin contact or by inhalation. 2783

T3 TP33 F-A, S-A Category A. Clear of living quarters. See entry above. 2783

T1 TP33 F-A, S-A Category A. Clear of living quarters. See entry above. 2783

T14 TP2 TP3 TP27 F-E, S-D Category B. Clear of living quarters. Pesticides frequently contain petroleum or coal tar distillates, or other flammable liquids. Miscibility with water depends upon the composition. Toxic if swallowed, by skin contact or by inhalation. 2784

T11 TP2 TP3 TP27 F-E, S-D Category B. Clear of living quarters. See entry above. 2784

UN No. (1)	PSN (2)	Class No. (3)	Subsidiary Risk(s) (4)	Packing Group (5)	Special Provisions (6)	Limited quantities (7a)	Excepted quantities (7b)	Packing		IBC		Tank instructions (15)	Provisions (14)	EMs (15)	Stowage and Segregation (16)	Properties and Observations (17)	UN No. (18)	
								Instruct-ions (8)	Instruc-tions (9)	Instruc-tions (10)	Provisions (11)							
2785	4-THAPENTAMAL	6.1	-	III	-	5 ℓ	E1	P001 LPO1	PPS1	IBC03	-	T4	TP1	F-A, S-A	Category D. Protected from sources of heat. Corrosive to metals. Corrosive to organic materials. Corrosive to acids and alkalis.	Colourless liquid with an extremely foul and persistent odour. Miscible with water. Corrosive to acids and bases. Toxic if swallowed, by skin contact or by inhalation.	2785	
2786	ORGANOTIN PESTICIDE, SOLID, TOXIC	6.1	P	I	61 274	0	E5	P002	-	IBC07	B1	T6	TP33	F-A, S-A	Category A. Clear of living quarters.	Solid pesticides present a very wide range of toxic hazard. Toxic if swallowed, by skin contact or by inhalation.	2786	
2786	ORGANOTIN PESTICIDE, SOLID, TOXIC	6.1	P	II	61 274	500 g	E4	P002	-	IBC08	B2 B4	T3	TP33	F-A, S-A	Category A. Clear of living quarters.	See entry above.	2786	
2786	ORGANOTIN PESTICIDE, SOLID, TOXIC	6.1	P	III	61 223 274	5 kg	E1	P002 LPO2	-	IBC08	B3	T1	TP33	F-A, S-A	Category A. Clear of living quarters.	See entry above.	2786	
2787	ORGANOTIN PESTICIDE, LIQUID, FLAMMABLE, TOXIC, flashpoint less than 23°C	3	6.1 P	I	61 274	0	E0	P001	-	-	-	T14	TP2 TP3 TP27	F-E, S-D	Category B. Clear of living quarters.	Pesticides frequently contain petroleum or coal tar distillates, or other flammable liquids. Miscibility with water depends upon the composition. Toxic if swallowed, by skin contact or by inhalation.	2787	
2787	ORGANOTIN PESTICIDE, LIQUID, FLAMMABLE, TOXIC, flashpoint less than 23°C	3	6.1 P	II	61 274	1 ℓ	E2	P001	-	IBC02	-	T11	TP2 TP3 TP27	F-E, S-D	Category B. Clear of living quarters.	See entry above.	2787	
2788	ORGANOTIN COMPOUND, LIQUID, N.O.S.	6.1	P	I	43 274	0	E5	P001	-	-	-	T14	TP2 TP3 TP27	F-A, S-A	Category A. Clear of living quarters.	A wide variety of toxic liquids. Toxic if swallowed, by skin contact or by inhalation.	2788	
2788	ORGANOTIN COMPOUND, LIQUID, N.O.S.	6.1	P	II	43 274	100 ml	E4	P001	-	IBC02	-	T11	TP2 TP3 TP27	F-A, S-A	Category A. Clear of living quarters.	See entry above.	2788	
2788	ORGANOTIN COMPOUND, LIQUID, N.O.S.	6.1	P	III	43 223 274	5 ℓ	E1	P001 LPO1	-	IBC03	-	T7	TP2 TP28	F-A, S-A	Category A. Clear of living quarters.	See entry above.	2788	
2789	ACETIC ACID, GLACIAL or ACETIC ACID SOLUTION, more than 80% acid, by mass	8	3	II	-	1 ℓ	E2	P001	-	IBC02	-	T7	TP2	F-E, S-C	Category A.	Colourless, flammable liquid with a pungent odour. When pure, crystallises below 16°C. Flashpoint 40°C. Boiling point 118°C. Corrosive to most other metals. Corrosive to skin, eyes and mucous membranes.	Explosive limits: 4% to 17%. Miscible with water. Corrosive to lead and most other metals. Corrosive to skin, eyes and mucous membranes.	2789
2790	ACETIC ACID SOLUTION more than 50% and less than 80% acid, by mass	8	-	II	-	1 ℓ	E2	P001	-	IBC02	-	T7	TP2	F-A, S-B	Category A.	Colourless liquid with a pungent odour. Miscible with water. Corrosive to lead and most other metals. Corrosive to skin, eyes and mucous membranes.	See entry above.	2790
2790	ACETIC ACID SOLUTION not less than 10% but not more than 50% acid, by mass	8	-	III	-	5 ℓ	E1	P001 LPO1	-	IBC03	-	T4	TP1	F-A, S-B	Category A.	See entry above.	2790	
2793	FERRIC METAL BORINGS, SHAVINGS, TURNINGS, or CUTTINGS in a form liable to self-heating	4.2	-	III	223 951	0	E1	P003 LPO2	PP20	IBC08	B3 B6	BN2	-	F-C, S-J	Category A.	These shavings are liable to self-heating and to ignite spontaneously, particularly when in a finely divided form and contaminated with such materials as unsaturated cutting oil, oily rags and other combustible matter. Self-heating or inadequate ventilation may cause dangerous depletion of oxygen in the storage spaces. Excessive amounts of cast iron shavings may cause a fire or explosion. The material should be protected from moisture prior to and after loading. If, during loading, the weather is inclement, hatches should be closed or otherwise protected to keep the material dry.	2793	

**TSFS 2015:66**  
**Bilaga 1**

UN No. (1)	PSN (2)	Class or Div (5)	Subsidiary Risk(s) (4)	Packing Group (3)	Special Provisions (6)	Limited quantities (7a)	Excepted quantities (7b)	Packing		IBC	
								Instructions (8)	Provisions (9)	Instructions (10)	Provisions (11)
	3.1.2	2.0	2.0	2.0, 1.3	3.3	3.4	3.5	4.1, 4	4.1, 4	4.1, 4	

UN No. (16)	Provisiones (15)	EMs (15)	Storage and Segregation (16)	Properties and Observations (17)
	4.2.5 4.3	4.2.5 7.8	7.1 to 7.7	

2794	BATTERIES, WET, FILLED WITH ACID electric storage	8	-	-	295	1 ℓ	E0	P801	-	-	-	F-A, S-B	Category A. For unit loads in open cargo transport units, category B.	Metal plates immersed in acid electrolyte in a glass, hard rubber or plastic container. Acid electrolyte is corrosive to most metals. Cause burns to skin, eyes and mucous membranes. Used batteries being transported for disposal or reclamation should be carefully checked prior to shipment to ensure the integrity of each battery and its suitability for transport.	2794
2795	BATTERIES, WET, FILLED WITH ALKALI electric storage	8	-	-	295	1 ℓ	E0	P801	-	-	-	F-A, S-B	Category A. For unit loads in open cargo transport units, category B. Separated from acids.	Metal plates immersed in alkaline electrolyte in a glass, hard rubber or plastic container. Alkaline electrolyte is corrosive to most metals, aluminium, zinc and tin. Reacts violently with acids. Cause burns to skin, eyes and mucous membranes. Used batteries being transported for disposal or reclamation should be carefully checked prior to shipment to ensure the integrity of each battery and its suitability for transport.	2795
2796	SULPHURIC ACID with not more than 5.1% acid or BATTERY FLUID, ACID	8	-	II	-	1 ℓ	E2	P001	-	IBC02	B20	F-A, S-B	Category B.	Colourless liquid; mixture not exceeding 1.405 relative density. Highly corrosive to most metals. Causes burns to skin, eyes and mucous membranes.	2796
2797	BATTERY FLUID, ALKALI	8	-	II	-	1 ℓ	E2	P001	-	IBC02	-	F-A, S-B	Category A. "Away from" ammonium salts. "Separated from" acids.	Reacts violently with acids. Reacts with ammonium salts, evolving ammonia gas. Corrosive to aluminium, zinc and tin.	2797
2798	PHENYLPHOSPHORUS DICHLORIDE	8	-	II	-	1 ℓ	E2	P001	-	IBC02	-	F-A, S-B	Category B. Clear of living quarters.	Colourless liquid. Hydrolyses in water. Fumes in air. Causes burns to skin, eyes and mucous membranes.	2798
2799	PHENYLPHOSPHORUS THIODICHLORIDE	8	-	II	-	1 ℓ	E2	P001	-	IBC02	-	F-A, S-B	Category B. Clear of living quarters.	Colourless liquid which fumes slightly in air. Reacts with water or steam, evolving toxic and flammable vapours. Causes burns to skin, eyes and mucous membranes.	2799
2800	BATTERIES, WET, NON-SPILLABLE electric storage	8	-	-	29 238	1 ℓ	E0	P003 PPI 6	-	-	-	F-A, S-B	Category A.	Metal plates immersed in gelled alkaline or acid electrolyte in a glass, hard rubber or plastics receptacle or a non-spillable type. When electrically short-circuited, causes burns to skin, eyes and mucous membranes.	2800
2801	DYE LIQUID, CORROSIVE, N.O.S. or DYE INTERMEDIATE, LIQUID, CORROSIVE, N.O.S.	8	-	I	274	0	E0	P001	-	-	-	F-A, S-B	Category A.	A wide range of corrosive liquids. Causes burns to skin, eyes and mucous membranes.	2801
2801	DYE LIQUID, CORROSIVE, N.O.S. or DYE INTERMEDIATE, LIQUID, CORROSIVE, N.O.S.	8	-	II	274	1 ℓ	E2	P001	-	IBC02	-	F-A, S-B	Category A.	See entry above.	2801
2801	DYE LIQUID, CORROSIVE, N.O.S. or DYE INTERMEDIATE, LIQUID, CORROSIVE, N.O.S.	8	-	III	223 274	5 ℓ	E1	P001 LPO1	-	IBC03	-	F-A, S-B	Category A.	See entry above.	2801
2802	COPPER CHLORIDE	8	-	III	-	500 g	E1	P002 LPO2	-	IBC08	B3	F-A, S-B	Category A.	White to yellow-brown crystals or powder. Partially to fully soluble in water. Corrosive to steel. Causes burns to skin, eyes and mucous membranes.	2802
2803	GALLIUM	8	-	III	-	5 kg	E0	P800 PM4	-	-	-	F-A, S-B	Category B. Protected from sources of heat.	Silvery-white metallic element that melts at 29°C, becoming a bright, shiny liquid, insoluble in water. Highly corrosive to aluminium. Harmful if swallowed, by skin contact or by inhalation. Special care should be taken to prevent contact with water. The use of plastic containers for storage should be prohibited in hovertank and other ships constructed from aluminium.	2803
2805	LITHIUM HYDRIDE, FUSED SOLID	4.3	-	II	-	500 g	E2	P410 PP31 PM40	-	IBC04	-	F-G, S-N	Category E. "Separated from" acids.	White, crystalline mass. Reacts with water, moisture or acids, evolving hydrogen which may be ignited by the heat of the reaction.	2805
2806	LITHIUM NITRIDE	4.3	-	I	-	0	E0	P403 PP31	IB04	B1	-	F-A, S-O	Category E.	Brownish-red crystals or fine, free-flowing powder. Reacts slowly with water to form lithium hydroxide and ammonia.	2806

UN No. (1)	PSN (2)	Class or Div. (3)	Subsidiary Risk(s) (4)	Packing Group (5)	Special Provisions (6)	Limited quantities (7a)	Excepted quantities (7b)	Packing		IBC		Tank instructions (15)	Provisions (14)	EMs (15)	Stowage and Segregation (16)	Properties and Observations (17)	UN No. (18)
								Instructions (8)	Provisions (9)	Instructions (10)	Provisions (11)						
	3.1.2	2.0	2.0	2.0	1.3	3.3	3.4	3.5	4.1, 4	4.1, 4	4.1, 4	4.2, 5	4.2, 5	5.4, 5.2	7.1 to 7.7		

2807 MAGNETIZED MATERIAL 9 - - - 960 - - - - - Not subject to the provisions of this Code but may be subject to provisions governing the transport of dangerous goods by other modes. 2807

2809 MERCURY	8	6.1	III	365	ED	5 kg	P800	-	-	-	-	-	-	F-A, S-B	Category B. Clear of living quarters. A silvery metallic element occurring in the liquid state at normal temperatures. Relative Density: 13.546. Melting point: -39°C. Highly corrosive to aluminum. Toxic if swallowed, by skin contact or by inhalation. Toxic if inhaled. Carriage should be prohibited in aluminum freight containers. Carriage should be prohibited in hovercraft and other ships constructed from aluminum.	2809
2810 TOXIC LIQUID, ORGANIC, N.O.S.	6.1	-	I	274	0	ES	P001	-	-	-	-	T14	TP2, TP3, TP27	F-A, S-A	Category B. Clear of living quarters. Toxic if swallowed, by skin contact or by inhalation.	2810

2810 TOXIC LIQUID, ORGANIC, N.O.S.	6.1	-	II	274	100 ml	E4	P001	-	IBC02	-	-	T11	TP2, TP3, TP27	F-A, S-A	Category B. Clear of living quarters. See entry above.	2810
------------------------------------	-----	---	----	-----	--------	----	------	---	-------	---	---	-----	----------------	----------	--	------

2810 TOXIC LIQUID, ORGANIC, N.O.S.	6.1	-	III	223	5 l	E1	P001, LPO1	-	IBC03	-	-	T7	TP1, TP28	F-A, S-A	Category A. Clear of living quarters. See entry above.	2810
------------------------------------	-----	---	-----	-----	-----	----	------------	---	-------	---	---	----	-----------	----------	--	------

2811 TOXIC SOLID, ORGANIC, N.O.S.	6.1	-	I	274	0	ES	P002	-	IBC99	-	-	T6	TP93	F-A, S-A	Category B. Toxic if swallowed, by skin contact or by inhalation.	2811
-----------------------------------	-----	---	---	-----	---	----	------	---	-------	---	---	----	------	----------	---	------

2811 TOXIC SOLID, ORGANIC, N.O.S.	6.1	-	II	274	500 g	E4	P002	-	IBC08	B2, B4	-	T3	TP3	F-A, S-A	Category B. See entry above.	2811
-----------------------------------	-----	---	----	-----	-------	----	------	---	-------	--------	---	----	-----	----------	------------------------------	------

2811 TOXIC SOLID, ORGANIC, N.O.S.	6.1	-	III	223	5 kg	E1	P002	-	IBC08	B3	-	T1	TP3	F-A, S-A	Category A. See entry above.	2811
-----------------------------------	-----	---	-----	-----	------	----	------	---	-------	----	---	----	-----	----------	------------------------------	------

2812 SODIUM ALUMINATE, SOLID	8	-	-	960	-	-	-	-	-	-	-	-	-	-	-	-	2812
------------------------------	---	---	---	-----	---	---	---	---	---	---	---	---	---	---	---	---	------

2813 WATER-REACTIVE SOLID, N.O.S.	4.3	-	I	274	0	ED	P403	PP3, PP3	IBC99	-	-	T9	TP7, TP3	F-C, S-N	Category E. Clear of living quarters. -	2813
-----------------------------------	-----	---	---	-----	---	----	------	----------	-------	---	---	----	----------	----------	---	------

2813 WATER-REACTIVE SOLID, N.O.S.	4.3	-	II	274	500 g	E2	P410	PP1, PM4, PP83	IBC07	B2	-	T3	TP3	F-C, S-N	Category E. Clear of living quarters. -	2813
-----------------------------------	-----	---	----	-----	-------	----	------	----------------	-------	----	---	----	-----	----------	---	------

2813 WATER-REACTIVE SOLID, N.O.S.	4.3	-	III	223	1 kg	E1	P410	PP3, PP83	IBC08	B4	-	T1	TP3	F-C, S-N	Category E. Clear of living quarters. -	2813
-----------------------------------	-----	---	-----	-----	------	----	------	-----------	-------	----	---	----	-----	----------	---	------

2814 INFECTIOUS SUBSTANCE, AFFECTING HUMANS	6.2	-	-	318	0	ED	P620	-	-	-	-	BK2	-	F-A, S-T	As approved by the competent authorities of the countries involved in the shipment. Substances which are dangerous to humans or to humans and animals.	2814
---	-----	---	---	-----	---	----	------	---	---	---	---	-----	---	----------	--	------

2815 N-AMINETHYLPIPERAZINE	8	-	III	-	5 l	E1	P001, LPO1	-	IBC03	-	-	T4	TP1	F-A, S-B	Category A. Keep as cool as reasonably practicable. Yellow liquid. Miscible with water. Corrosive to skin, eyes and mucous membranes.	2815
----------------------------	---	---	-----	---	-----	----	------------	---	-------	---	---	----	-----	----------	---	------

2817 AMMONIUM HYDROGENDIFLUORIDE SOLUTION	8	6.1	II	-	1 l	E2	P001	-	IBC02	B20	-	T8	TP2, TP3	F-A, S-B	Category B. Clear of living quarters. Colorless liquid. Miscible with water. Highly corrosive to most metals and to skin, eyes and mucous membranes. Causes burns if inhaled or by inhalation.	2817
---	---	-----	----	---	-----	----	------	---	-------	-----	---	----	----------	----------	--	------

UN		PSN		Class or Div (5)		Subsidiary Risk(s) (4)		Packing Group (3)		Special Provisions (6)		Limited quantities (7a)		Excepted quantities (7b)		Instruct-ions (8)		Provisions (9)		Institu-tions (10)		Provisions (11)	
	(1)		(2)	2.0	2.0	2.0	2.0	2.0	2.0	2.0	2.0	2.0	2.0	2.0	2.0	2.0	2.0	2.0	2.0	2.0	2.0	2.0	2.0
				3.1.2																			

UN		PSN		Class or Div (5)		Subsidiary Risk(s) (4)		Packing Group (3)		Special Provisions (6)		Limited quantities (7a)		Excepted quantities (7b)		Instruct-ions (8)		Provisions (9)		Institu-tions (10)		Provisions (11)	
	(1)		(2)	2.0	2.0	2.0	2.0	2.0	2.0	2.0	2.0	2.0	2.0	2.0	2.0	2.0	2.0	2.0	2.0	2.0	2.0	2.0	2.0
				3.1.2																			

2817 AMMONIUM HYDROGENDIFLUORIDE SOLUTION 8 6.1 III 223 5 ℓ E1 P001 - IBC03 - 2817

2818 AMMONIUM POLYSULPHIDE SOLUTION 8 6.1 II - 1 ℓ E2 P001 - IBC02 - 2818

2818 AMMONIUM POLYSULPHIDE SOLUTION 8 6.1 III 223 5 ℓ E1 P001 - IBC03 - 2818

2819 AMYL ACID PHOSPHATE 8 - III - 5 ℓ E1 P001 LPO1 - IBC03 - 2819

2820 BUTYRIC ACID 8 - III - 5 ℓ E1 P001 LPO1 - IBC03 - 2820

2821 PHENOL SOLUTION 6.1 - II - 100 ml E4 P001 - IBC02 - 2821

2821 PHENOL SOLUTION 6.1 - III 223 5 ℓ E1 P001 LPO1 - IBC03 - 2821

2822 2-CHLOROPYRIDINE 6.1 - II - 100 ml E4 P001 - IBC02 - 2822

2823 CROTIC ACID, SOLID 8 - III - 5 kg E1 P002 LPO2 - IBC08 B2 B3 - 2823

2826 ETHYL CHLOROTHIOFORMATE 8 3 P II - 0 E2 P001 - - - - 2826

2829 CAPROIC ACID 8 - III - 5 ℓ E1 P001 LPO1 - IBC03 - 2829

2830 LITHIUM FERROSILICON 4.3 - II - 500 g E2 P410 P31 PM40 - IBC07 B2 - 2830

2831 1,1,1-TRICHLOROETHANE 6.1 - III - 5 ℓ E1 P001 LPO1 - IBC03 - 2831

2834 PHOSPHOROUS ACID 8 - III - 5 kg E1 P002 LPO2 - IBC08 B3 - 2834

2835 SODIUM ALUMINIUM HYDRIDE 4.3 - II - 500 g E2 P410 P31 PM40 - IBC04 - 2835

Category B. Clear of living quarters. See entry above.

Category B. Keep as cool as reasonably practicable. Clear of living quarters. "Separated from" acids.

Category B. Keep as cool as reasonably practicable. Clear of living quarters. "Separated from" acids.

Category A.

Category A. Keep as cool as reasonably practicable.

Category A.

Category A. Clear of living quarters.

Category A. Keep as cool as reasonably practicable.

Category A.

Category A. Clear of living quarters.

Category A. Keep as cool as reasonably practicable.

Category A.

Category A. Clear of living quarters.

Category A. Keep as cool as reasonably practicable.

Category A.

Category A. Clear of living quarters.

Category E. Only to be loaded under dry weather conditions. Clear of living quarters.

Category A. Clear of living quarters.

Category A. Protected from sources of heat.

Category E. "Separated from" acids.

Category E. "Separated from" acids.

Category E. "Separated from" acids.

Category E. "Separated from" acids.

Category E. "Separated from" acids.

Category E. "Separated from" acids.

Category E. "Separated from" acids.

Category E. "Separated from" acids.

Category E. "Separated from" acids.

Category E. "Separated from" acids.

Category E. "Separated from" acids.

Category E. "Separated from" acids.

Category E. "Separated from" acids.

Category E. "Separated from" acids.

Category E. "Separated from" acids.

Unstable yellowish liquid with foul odour (of rotten eggs). Miscible with water. Burns violently with acids. Decomposes when heated, with evolving hydrogen sulphide, a toxic and flammable gas. Toxic if swallowed, by skin contact or by inhalation. Causes burns to skin, eyes and mucous membranes.

See entry above.

See entry above.

Clear colourless liquid. A mixture of primary and amyl isomers. Immiscible with water. Corrosive to skin, eyes and mucous membranes.

Colourless liquid with a penetrating and unpleasant odour. Freezing point: -5 to -6 °C. Miscible with water. Corrosive to most metals. Harmful if swallowed, by inhalation. Corrosive to skin, eyes and mucous membranes.

Yellowish solutions with a perceptible odour. Toxic if swallowed, by skin contact or by inhalation. Rapidly absorbed through the skin.

See entry above.

See entry above.

Colourless, flammable liquid. Flashpoint: 29°C c.c. Causes burns to skin, eyes and mucous membranes.

Oily, colourless or yellowish liquid. Melting point: -4°C. Partially miscible with water. Corrosive to mild steel. Causes burns to skin, eyes and mucous membranes.

Dark, crystalline, metal-like powder or brittle lumps. In contact with moisture, evolves flammable and toxic gases.

Colourless liquid, immiscible with water. Decomposes when heated, evolving highly toxic fumes (phosgene and hydrogen chloride). Toxic if swallowed, by skin contact or by inhalation. Narcotic in high concentrations.

Colourless to yellow deliquescent crystals. Soluble in water. Mildly corrosive to most metals. Causes burns to skin, eyes and mucous membranes.

White, crystalline solid. Reacts with water, moisture or acids evolving hydrogen, which may be ignited by the heat of the reaction.

UN No. (1)	PSN (2)	Class No. or Div (3)	Subsidiary Risk(s) (4)	Packing Group (5)	Special Provisions (6)	Limited quantities (7a)	Excepted quantities (7b)	Packing		IBC		Provisions (15)	Tank instructions (16)	Stowage and Segregation (16)	EMs (15)	Provisions (14)	EHS (15)	UN No. (18)
								Instruc-tions (8)	Provisions (9)	Instruc-tions (10)	Provisions (11)							
3.1.2		2.0	2.0	2.0, 1.3	3.3	3.4	3.5	4.1, 4	P001	-	IBC02	-						2837
2837 BISULPHATES, AQUEOUS SOLUTION																		
8		8	-	III	223	5 l	E1	P001	-	IBC03	-							2837
2837 BISULPHATES, AQUEOUS SOLUTION																		
3		3	-	II	-	1 l	E2	P001	-	IBC02	-							2838
2838 VINYL BUTYRATE, STABILIZED																		
6.1		6.1	-	II	-	100 ml	E4	P001	-	IBC02	-							2839
2839 ALDOL																		
3		3	-	III	-	5 l	E1	P001	-	IBC03	-							2840
2840 BUTYRALDOXIME																		
3		3	6.1	III	-	5 l	E1	P001	-	IBC03	-							2841
2841 DI-n-AMYLAMINE																		
3		3	-	III	-	5 l	E1	P001	-	IBC03	-							2842
2842 NITROETHANE																		
4.3		4.3	-	III	-	1 kg	E1	P410	PP31	IBC08	B4							2844
2844 CALCIUM MANGANESE SILICON																		
4.2		4.2	-	I	274	0	E0	P400	PP31	-	-							2845
2845 PYROPHORIC LIQUID, ORGANIC, N.O.S.																		
4.2		4.2	-	I	274	0	E0	P404	PP31	-	-							2846
2846 PYROPHORIC SOLID, ORGANIC, N.O.S.																		
6.1		6.1	-	III	-	5 l	E1	P001	-	IBC03	-							2849
2849 3-CHLOROPROPANOL-1																		
3		3	-	III	-	5 l	E1	P001	-	IBC03	-							2850
2850 PROPYLENE TETRAMER																		
8		8	-	II	-	1 l	E2	P001	-	IBC02	-							2851
2851 BORON TRIFLUORIDE DIHYDRATE																		
4.1		4.1	-	I	28	0	E0	P406	PP24	PP31	-							2852
2852 DICRYL SULPHIDE, WETTED with not less than 10% water, by mass																		
6.1		6.1	-	III	-	5 kg	E1	P002	LP02	IBC08	B3							2853
2853 MAGNESIUM FLUOROSILICATE																		
6.1		6.1	-	III	-	5 kg	E1	P002	LP02	IBC08	B3							2854
2854 AMMONIUM FLUOROSILICATE																		

**TSFS 2015:66  
Bilaga 1**

UN No. (1)	PSN (2)	Class No. (3)	Subsidiary Risk(s) (4)	Packing Group (5)	Special Provisions (6)	Limited quantities (7a)	Excepted quantities (7b)	Packing		IBC		Portable tanks and bulk containers		EMs (15)	Stowage and Segregation (16)	Properties and Observations (17)	UN No. (18)	
								Instruc-tions (8)	Provisions (9)	Instruc-tions (10)	Provisions (11)	Tank instructions (12)	Provisions (13)					TP33 (14)
3.1.2		2.0	2.0	2.0, 1.3	3.3	3.4	3.5	4.1, 4	4.1, 4	4.1, 4				4.2, 5	5.4, 5.2	7.8	7.1 to 7.7	
2855	ZINC FLUOROSILICATE	6.1	-	III	-	5 kg	E1	P002 LP02	-	IBC08	B3	TI	TP33	F-A, S-A	Category A. "Separated from" acids. Solids which react with acids, evolving hydrogen fluoride and silicon tetrafluoride gases. Toxic if swallowed, by skin contact or by dust inhalation.		2855	
2856	FLUOROSILICATES, N.O.S.	6.1	-	III	274	5 kg	E1	P002 LP02	-	IBC08	B3	TI	TP33	F-A, S-A	Category A. "Separated from" acids. Solids which react with acids, evolving hydrogen fluoride and silicon tetrafluoride gases. Toxic if swallowed, by skin contact or by dust inhalation.		2856	
2857	REFRIGERATING MACHINES containing non-flammable, non-toxic gases or ammonia solutions (UN 2672)	2.2	-	-	-	0	E0	P003	PP32	-	-	-	-	F-C, S-V	Category A.	-		2857
2858	ZIRCONIUM, DRY coiled wire, finished metal sheets, strip (thinner than 254 microns but not thinner than 18 microns)	4.1	-	III	921	5 kg	E1	P002 LP02	-	-	-	-	-	F-G, S-C	Category A.	Hard silvery metal.		2858
2859	AMMONIUM METAVANADATE	6.1	-	II	-	500 g	E4	P002	-	IBC08	B2 B4	T3	TP33	F-A, S-A	Category A. Segregation as for class S.1 but "Away from" classes 4.1, 5.1 and 7.	White crystalline powder. Slightly soluble in water. May act as an oxidizing substance. Toxic if swallowed, by skin contact or by inhalation.	2859	
2861	AMMONIUM POLYVANADATE	6.1	-	II	-	500 g	E4	P002	-	IBC08	B2 B4	T3	TP33	F-A, S-A	Category A. Segregation as for class S.1 but "Away from" classes 4.1, 5.1 and 7.	Orange powder. Slightly soluble in water. May act as an oxidizing substance. Toxic if swallowed, by skin contact or by inhalation.	2861	
2862	VANADIUM PENTOXIDE, non-fused form	6.1	-	III	-	5 kg	E1	P002 LP02	-	IBC08	B3	TI	TP33	F-A, S-A	Category A.	Brownish powder. Slightly soluble in water. Toxic if swallowed, by skin contact or by inhalation.	2862	
2863	SODIUM AMMONIUM VANADATE	6.1	-	II	-	500 g	E4	P002	-	IBC08	B2 B4	T3	TP33	F-A, S-A	Category A.	Orange wet cake (with 10% to 15% water). Soluble in water. Toxic if swallowed, by skin contact or by dust inhalation.	2863	
2864	POTASSIUM METAVANADATE	6.1	-	II	-	500 g	E4	P002	-	IBC08	B2 B4	T3	TP33	F-A, S-A	Category A.	White crystalline powder. Slightly soluble in water. Toxic if swallowed, by skin contact or by inhalation.	2864	
2865	HYDROXYLAMINE SULPHATE	8	-	III	-	5 kg	E1	P002 LP02	-	IBC08	B3	TI	TP33	F-A, S-B	Category A.	Colourless to white crystalline powder. Soluble in water. May decompose explosively when heated. Causes burns to skin, eyes and mucous membranes.	2865	
2869	TITANIUM TRICHLORIDE MIXTURE	8	-	II	-	1 kg	E2	P002	-	IBC08	B2 B4	T3	TP33	F-A, S-B	Category A. Clear of living quarters.	Violet crystalline solid. Reacts in moist air or in water, evolving heat and hydrogen chloride, an irritating and corrosive gas apparent as white fumes. In the presence of moisture, corrosive to most metals. Causes burns to skin, eyes and mucous membranes.	2869	
2869	TITANIUM TRICHLORIDE MIXTURE	8	-	III	223	5 kg	E1	P002 LP02	-	IBC08	B3	TI	TP33	F-A, S-B	Category A. Clear of living quarters. See entry above.		2869	
2870	ALUMINIUM BOROHYDRIDE	4.2	4.3	I	-	0	E0	P400	-	-	-	T21 TP33	TP7 TP33	F-G, S-M	Category D.	Liquid. Ignites spontaneously in air. Reacts with water or steam to produce heat or hydrogen, which may form explosive mixtures with air.	2870	
2870	ALUMINIUM BOROHYDRIDE IN DEVICES	4.2	4.3	I	-	0	E0	P002	PP13	-	-	-	-	F-G, S-M	Category D	-		2870
2871	ANTHONY POWDER	6.1	-	III	-	5 kg	E1	P002 LP02	-	IBC08	B3	TI	TP33	F-A, S-A	Category A.	Metallic antimony in the form of a fine grey powder (insoluble in water). Toxic if swallowed, by skin contact or by dust inhalation.	2871	
2872	DIBROMOCHLOROPROPANES	6.1	-	II	-	100 ml <sup>a</sup>	E4	P001	-	IBC02	-	T7	TP2	F-A, S-A	Category A.	Colourless liquid with a perceptible odour. Immiscible with water. Toxic if swallowed, by skin contact or by inhalation.	2872	



UN No. (1)	PSN (2)	Class No. (3)	Subsidiary Risk(s) (4)	Packing Group (5)	Special Provisions (6)	Limited quantities (7a)	Excepted quantities (7b)	Packaging		IBC		Portable tanks and bulk containers		EMS (15)	Stowage and Segregation (16)	Properties and Observations (17)	UN No. (18)
								Instruc-tions (8)	Provisions (9)	Instruc-tions (10)	Provisions (11)	Tank instructions (12)	Provisions (13)				
3.1.2		2.0	2.0	2.0	3.3	3.4	3.5	4.1,4	4.1,4	4.1,4	4.1,4	4.2,5	7.1 to 7.7	54,5,2			
2872	DIBROMOCHLOROPROPANES	6.1	-	III	223	5 f	E1	P001	-	IBC03	-	T4	TP1	F-A, S-A	Category A.	See entry above.	2872

2873	DIBUTYLAMINOETHANOL	6.1	-	III	-	5 f	E1	P001	-	IBC03	-	T4	TP1	F-A, S-A	Category A.	Colourless liquid with a perceptible odour. Miscible with water. Toxic if swallowed, by skin contact or by inhalation.	2873
2874	FURFURYL ALCOHOL	6.1	-	III	-	5 f	E1	P001	-	IBC03	-	T4	TP1	F-A, S-A	Category A.	Clear, colourless, mobile liquid, becoming brown to dark-red upon exposure to light and air. Miscible with water. Reacts explosively with oxidizing substances. Toxic if swallowed, by skin contact or by inhalation.	2874
2875	HEXACHLOROPHENE	6.1	-	III	-	5 kg	E1	P002	-	IBC08	B3	T1	TP33	F-A, S-A	Category A.	White, colourless powder or crystals, insoluble in water. Toxic if swallowed, by skin contact or by dust inhalation.	2875
2876	RESORCINOL	6.1	-	III	-	5 kg	E1	P002	-	IBC08	B3	T1	TP33	F-A, S-A	Category A.	White to pink crystals. Soluble in water. Toxic if swallowed, by skin contact or by dust inhalation.	2876
2878	TITANIUM SPONGE GRANULES or TITANIUM SPONGE POWDERS	4.1	-	III	223	5 kg	E1	P002	-	IBC08	B3	T1	TP33	F-G, S-G	Category D.	Silvery grey granules or dark grey, amorphous powder. May react with carbon dioxide, evolving oxygen. Forms explosive mixtures with oxidizing substances.	2878
2879	SELENIUM OXYCHLORIDE	8	6.1	I	-	0	ED	P001	-	-	-	T10	TP2	F-A, S-B	Category E.	Colourless, yellowish liquid. Reacts violently with water, evolving hydrogen chloride, an irritating and corrosive gas apparent as white fumes, in the presence of moisture, highly corrosive to most metals. Toxic if swallowed, by skin contact or by dust inhalation. Causes severe burns to skin, eyes and mucous membranes.	2879
2880	CALCIUM HYPOCHLORITE, HYDRATED or CALCIUM HYPOCHLORITE, HYDRATED MIXTURE with not less than 5.5% but not more than 16% water	5.1	-	II	314	1 kg	E2	P002	P85	-	-	-	-	F-H, S-Q	Category D.	White, yellowish solid (powder, granules or tablets) with chlorine-like odour. Soluble in water. May cause fire in contact with organic material or ammonium compounds. Substances are liable to exothermic decomposition at elevated temperatures. This condition may lead to fire or explosion. Decomposition may lead to the evolution of toxic gases, including ammonia, cyanides, manganese, cobalt, magnesium and their compounds. Liable to heat slowly.	2880
2880	CALCIUM HYPOCHLORITE, HYDRATED or CALCIUM HYPOCHLORITE, HYDRATED MIXTURE with not less than 5.5% but not more than 16% water	5.1	-	III	223	5 kg	E1	P002	P85	-	-	-	-	F-H, S-Q	Category D.	Protected from sources of heat. Cargo transport units shall be protected from direct sunlight. Packages in cargo transport units shall be stowed so as to allow for adequate circulation throughout the cargo. "Separated from" ammonium compounds, acids, cyanides, hydrogen peroxide and liquid organic substances.	2880
2881	METAL CATALYST, DRY	4.2	-	I	274	0	ED	P404	PP31	-	-	T21	TP7	F-G, S-M	Category C.	Liable to ignite spontaneously in air.	2881
2881	METAL CATALYST, DRY	4.2	-	II	274	0	E2	P410	PP31	IBC06	B2	T3	TP33	F-G, S-M	Category C.	See entry above.	2881
2881	METAL CATALYST, DRY	4.2	-	III	223	0	E1	P002	PP31	IBC08	B3	T1	TP33	F-G, S-M	Category C.	See entry above.	2881
2900	INFECTIOUS SUBSTANCE, AFFECTING ANIMALS only	6.2	-	-	318	0	ED	P620	-	-	-	BK2	-	F-A, S-T	-	Substances which are dangerous to animals only. For action to be taken in the event of damage to, leaking from, package containing infectious substances, refer to [7.8.3].	2900

UN No. (1)	PSN (2)	Class No. (3)	Subsidiary Risk(s) (4)	Packing Group (5)	Special Provisions (6)	Limited quantities (7a)	Excepted quantities (7b)	Packing			IBC			
								Class (8)	Subsidiary Risk(s) (9)	Instructions (10)	Provisions (11)	Instructions (12)	Provisions (13)	
	3.1.2	2.0	2.0	2.0, 1.3	3.3	3.4	3.5	4.1, 4	4.1, 4	4.1, 4	4.1, 4	4.1, 4		
2901	BROMINE CHLORIDE	2.3	5.1/8	-	-	0	EO	P200	-	-	-	-	-	

UN No. (18)	Properties and Observations (17)	Storage and Segregation (16)	Portable tanks and bulk containers		EMs (15)	F-C, S-W
			Tank instructions (19)	Provisions (20)		
		7.1 to 7.7	4.2.5 4.3	4.2.5 4.3	54.3.2 7.8	
2901	Reddish-yellow non-flammable, toxic and corrosive gas. When heated to 100°C, it decomposes to chlorine gas and chlorine. Reacts with water, evolving toxic and corrosive fumes. Powerful oxidizing agent which may cause violent fires with combustible materials. Much heavier than air. Highly irritating to skin, eyes and mucous membranes.		-	-	-	Category D. Clear of living quarters. Clear of living quarters. Clear of living quarters. Class 3 but "Separated from" Class 7.

2902	PESTICIDE, LIQUID, TOXIC, N.O.S.	6.1	-	I	61 274	0	ES	P001	-	-	-	-	T14 TP2 TP3 TP7	F-A, S-A	Category B. Clear of living quarters. Miscibility with water depends upon the composition. Toxic if swallowed, by skin contact or by inhalation.	2902	
2902	PESTICIDE, LIQUID, TOXIC, N.O.S.	6.1	-	II	61 274	100 ml	E4	P001	-	IBC02	-	-	TP2 TP3 TP7	F-A, S-A	Category B. Clear of living quarters. See entry above.	2902	
2902	PESTICIDE, LIQUID, TOXIC, N.O.S.	6.1	-	III	61 223 274	5 l	E1	P001 LP01	-	IBC03	-	-	TP2 TP28	F-A, S-A	Category A. Clear of living quarters. See entry above.	2902	
2903	PESTICIDE, LIQUID, TOXIC, FLAMMABLE, N.O.S. Flashpoint not less than 23°C	6.1	3	I	61 274	0	E5	P001	-	-	-	-	TP2 TP3 TP7	F-E, S-D	Category B. Clear of living quarters. Liquid flammable pesticides having a flashpoint between 23°C and 60°C c.c., presenting a very wide range of toxic hazard. They frequently contain petroleum or coal tar distillates, or other flammable liquids. Flashpoint depends on the composition. Toxic if swallowed, by skin contact or by inhalation.	2903	
2903	PESTICIDE, LIQUID, TOXIC, FLAMMABLE, N.O.S. Flashpoint not less than 23°C	6.1	3	II	61 274	100 ml	E4	P001	-	IBC02	-	-	TP2 TP3 TP7	F-E, S-D	Category B. Clear of living quarters. See entry above.	2903	
2903	PESTICIDE, LIQUID, TOXIC, FLAMMABLE, N.O.S. Flashpoint not less than 23°C	6.1	3	III	61 223 274	5 l	E1	P001	-	IBC03	-	-	TP2	F-E, S-D	Category A. Clear of living quarters. See entry above.	2903	
2904	CHLOROPHENOLATES, LIQUID or PHENOLATES, LIQUID	8	-	III	-	5 l	E1	P001 LP01	-	IBC03	-	-	-	F-A, S-B	Category A.	A wide range of corrosive liquids. Cause burns to skin, eyes and mucous membranes.	2904
2905	CHLOROPHENOLATES, SOLID or PHENOLATES, SOLID	8	-	III	-	5 kg	E1	P002 LP02	-	IBC08	B3	-	TP33	F-A, S-B	Category A.	A wide range of corrosive solids. Soluble in water. Cause burns to skin, eyes and mucous membranes.	2905
2907	ISOCYANIDE DINITRATE MIXTURE with not less than 60% isocyanide, inammonia, starch, or calcium hydrogen phosphate	4.1	-	II	127	0	EO	P406 PB0	IB2 IB6	IBC06	B2 B12	-	-	F-A, S-J	Category E. "Away from" Class 3 and heavy metals and their salts.	Desensitized explosive. Pure isocyanide dinitrate is explosive. May form extremely sensitive compounds with heavy metals or their salts.	2907
2908	RADIOACTIVE MATERIAL, EXCEPTED PACKAGE - EMPTY PACKAGING	7	See SP290	-	290	0	EO	See 4.1.9	See 4.1.9	See 4.1.9	See 4.1.9	-	-	F-1, S-5	Category A.	See 1.5.1 and 5.1.5.4.2.	2908
2909	RADIOACTIVE MATERIAL, EXCEPTED PACKAGE - LIMITED QUANTITY OF URANIUM or DEPLETED URANIUM or NATURAL THORIUM	7	See SP290	-	290	0	EO	See 4.1.9	See 4.1.9	See 4.1.9	See 4.1.9	-	-	F-1, S-5	Category A.	See 1.5.1 and 5.1.5.4.2.	2909
2910	RADIOACTIVE MATERIAL, EXCEPTED PACKAGE - LIMITED QUANTITY OF MATERIAL	7	See SP290	-	290	0	EO	See 4.1.9	See 4.1.9	See 4.1.9	See 4.1.9	-	-	F-1, S-5	Category A.	See 1.5.1 and 5.1.5.4.2.	2910
2911	RADIOACTIVE MATERIAL, EXCEPTED PACKAGE - INSTRUMENTS or ARTICLES	7	See SP290	-	290	0	EO	See 4.1.9	See 4.1.9	See 4.1.9	See 4.1.9	-	-	F-1, S-5	Category A.	See 1.5.1 and 5.1.5.4.2.	2911

UN No. (1)	PSN (2)	Class of Div (5)	Subsidiary Risk(s) (4)	Packing Group (3)	Special Provisions (6)	Limited quantities (7a)	Excepted quantities (7b)	Packing		IBC		Tank instructions (15)	Provisions (14)	EIMS (15)	Stowage and Segregation (16)	Properties and Observations (17)	UN No. (18)
								Instructions (8)	Quantities (9)	Instructions (10)	Provisions (11)						
	3.1.2	2.0	2.0	2.0, 1.3	3.3	3.4	3.5	4.1, 4	4.1, 4	4.1, 4	4.1, 4	4.2, 5 4.3	4.2, 5	5.4, 5.2 7.8	7.1 to 7.7		

UN No. (1)	PSN (2)	Class of Div (5)	Subsidiary Risk(s) (4)	Packing Group (3)	Special Provisions (6)	Limited quantities (7a)	Excepted quantities (7b)	Packing		IBC		Tank instructions (15)	Provisions (14)	EIMS (15)	Stowage and Segregation (16)	Properties and Observations (17)	UN No. (18)
								Instructions (8)	Quantities (9)	Instructions (10)	Provisions (11)						
2912	RADIOACTIVE MATERIAL, LOW SPECIFIC ACTIVITY (LSA-I), non fissile or fissile-excepted	7	See SP72	-	172 317 325	0	EO	See 4.1.9	See 4.1.9	See 4.1.9	See 4.1.9	T5	TP4	F-1, S-5	Category A, except for uranium and plutonium for which category D applies.	See 1.5.1	2912
2913	RADIOACTIVE MATERIAL, SURFACE CONTAMINATED OBJECTS (SCO-I or SCO-II), non fissile or fissile-excepted	7	See SP72	-	172 317	0	EO	See 4.1.9	See 4.1.9	See 4.1.9	See 4.1.9	T5	TP4	F-1, S-5	Category A.	See 1.5.1	2913
2915	RADIOACTIVE MATERIAL, TYPE A PACKAGE, non-special form, non fissile or fissile-excepted	7	See SP72	-	172 317 325	0	EO	See 4.1.9	See 4.1.9	See 4.1.9	See 4.1.9	-	-	F-1, S-5	Category A, except for uranyl nitrate hexahydrate solution, uranium metal pyrophoric and thorium metal pyrophoric for which category D applies.	See 1.5.1	2915
2916	RADIOACTIVE MATERIAL, TYPE B(U) PACKAGE, non fissile or fissile-excepted	7	See SP72	-	172 317 325	0	EO	See 4.1.9	See 4.1.9	See 4.1.9	See 4.1.9	-	-	F-1, S-5	Category A, taking account of any supplementary requirements specified in the transport documents.	See 1.5.1 For ships transporting an INF cargo as defined in regulation VII/1.4 of the SOLAS Convention, 1974, as amended, refer also to the INF Code.	2916
2917	RADIOACTIVE MATERIAL, TYPE B(M) PACKAGE, non fissile or fissile-excepted	7	See SP72	-	172 317 325	0	EO	See 4.1.9	See 4.1.9	See 4.1.9	See 4.1.9	-	-	F-1, S-5	Category A, taking account of any supplementary requirements specified in the transport documents.	See 1.5.1 For ships transporting an INF cargo as defined in regulation VII/1.4 of the SOLAS Convention, 1974, as amended, refer also to the INF Code.	2917
2919	RADIOACTIVE MATERIAL TRANSPORTED UNDER SPECIAL ARRANGEMENT, non fissile or fissile-excepted	7	See SP72	-	172 317 325	0	EO	See 4.1.9	See 4.1.9	See 4.1.9	See 4.1.9	-	-	F-1, S-5	Category A, taking account of any supplementary requirements specified in the competent authority approval certificate(s).	See 1.5.1 For ships transporting an INF cargo as defined in regulation VII/1.4 of the SOLAS Convention, 1974, as amended, refer also to the INF Code.	2919
2920	CORROSIVE LIQUID, FLAMMABLE, N.O.S.	8	3	I	274	0	EO	P001	-	-	-	T14 TP27	TP2 TP27	F-E, S-C	Category C. Protected from sources of heat. Clear of living quarters.	Causes burns to skin, eyes and mucous membranes.	2920
2920	CORROSIVE LIQUID, FLAMMABLE, N.O.S.	8	3	II	274	1 ℓ	E2	P001	-	IBC02	-	T11 TP27	TP2 TP27	F-E, S-C	Category C. Protected from sources of heat. Clear of living quarters.	See entry above.	2920
2921	CORROSIVE SOLID, FLAMMABLE, N.O.S.	8	4.1	I	274	0	EO	P002	-	IBC99	-	T6	TP33	F-A, S-G	Category B. Keep as cool as reasonably practicable. Protected from sources of heat.	Causes burns to skin, eyes and mucous membranes.	2921
2921	CORROSIVE SOLID, FLAMMABLE, N.O.S.	8	4.1	II	274	1 kg	E2	P002	-	IBC08	B2 B4	T3	TP33	F-A, S-G	Category B. Keep as cool as reasonably practicable. Protected from sources of heat.	See entry above.	2921
2922	CORROSIVE LIQUID, TOXIC, N.O.S.	8	6.1	I	274	0	EO	P001	-	-	-	T14 TP23 TP27	TP2 TP27	F-A, S-B	Category B. Clear of living quarters.	Causes burns to skin, eyes and mucous membranes. Toxic if swallowed, by skin contact or by inhalation.	2922
2922	CORROSIVE LIQUID, TOXIC, N.O.S.	8	6.1	II	274	1 ℓ	E2	P001	-	IBC02	-	T7	TP2	F-A, S-B	Category B. Clear of living quarters.	See entry above.	2922
2922	CORROSIVE LIQUID, TOXIC, N.O.S.	8	6.1	III	223 274	5 ℓ	E1	P001	-	IBC03	-	T7	TP1 TP28	F-A, S-B	Category B. Clear of living quarters.	See entry above.	2922
2923	CORROSIVE SOLID, TOXIC, N.O.S.	8	6.1	I	274	0	EO	P002	-	IBC99	-	T6	TP33	F-A, S-B	Category B. Clear of living quarters.	Causes burns to skin, eyes and mucous membranes. Toxic if swallowed, by skin contact or by inhalation.	2923
2923	CORROSIVE SOLID, TOXIC, N.O.S.	8	6.1	II	274	1 kg	E2	P002	-	IBC08	B2 B4	T3	TP33	F-A, S-B	Category B. Clear of living quarters.	See entry above.	2923

**TSFS 2015:66  
Bilaga 1**

UN No. (1)	PSN (2)	Class No. (3)	Subsidiary Risk(s) (4)	Packing Group (5)	Special Provisions (6)	Limited quantities (7a)	Excepted quantities (7b)	Packing			IBC Provisions (11)	UN No. (16)	Properties and Observations (17)			
								Class No. (8)	Subsidiary Risk(s) (9)	Institutions (10)						
2923	CORROSIVE SOLID, TOXIC, N.O.S.	8	6.1	III	223 274	5 kg	E1	P002	-	IBC08	B3	TI	TP33	F-A, S-B	Category B. Clear of living quarters. See entry above.	2923
2924	FLAMMABLE LIQUID, CORROSIVE, N.O.S.	3	8	I	274	0	EO	P001	-	-	-	T14	TP2	F-E, S-C	Category E. Clear of living quarters. Causes burns to skin, eyes and mucous membranes.	2924
2924	FLAMMABLE LIQUID, CORROSIVE, N.O.S.	3	8	III	223 274	5 ℓ	E1	P001	-	IBC03	-	T7	TP1 TP28	F-E, S-C	Category A. Clear of living quarters. See entry above.	2924
2925	FLAMMABLE SOLID, CORROSIVE, ORGANIC, N.O.S.	4.1	8	II	274 915	1 kg	E2	P002	-	IBC06	B2	T3	TP33	F-A, S-G	Category D. Clear of living quarters. Causes burns to skin, eyes and mucous membranes.	2925
2925	FLAMMABLE SOLID, CORROSIVE, ORGANIC, N.O.S.	4.1	8	III	223 274 915	5 kg	E1	P002	-	IBC06	-	T1	TP33	F-A, S-G	Category D. Clear of living quarters. See entry above.	2925
2926	FLAMMABLE SOLID, TOXIC, ORGANIC, N.O.S.	4.1	6.1	II	274 915	1 kg	E2	P002	-	IBC06	B2	T3	TP33	F-A, S-C	Category B. Clear of living quarters. Toxic if swallowed, by skin contact or by dust inhalation. Should be handled with care to minimize exposure, particularly to dust.	2926
2926	FLAMMABLE SOLID, TOXIC, ORGANIC, N.O.S.	4.1	6.1	III	223 274 915	5 kg	E1	P002	-	IBC06	-	T1	TP33	F-A, S-G	Category B. Clear of living quarters. See entry above.	2926
2927	TOXIC LIQUID, CORROSIVE, ORGANIC, N.O.S.	6.1	8	I	274 315	0	E5	P001	-	-	-	T14	TP2 TP13 TP27	F-A, S-B	Category B. Clear of living quarters. Toxic if swallowed, by skin contact or by inhalation. Causes burns to skin, eyes and mucous membranes.	2927
2927	TOXIC LIQUID, CORROSIVE, ORGANIC, N.O.S.	6.1	8	II	274	100 ml	E4	P001	-	IBC02	-	T11	TP2 TP27	F-A, S-B	Category B. Clear of living quarters. See entry above.	2927
2928	TOXIC SOLID, CORROSIVE, ORGANIC, N.O.S.	6.1	8	I	274	0	E5	P002	-	IBC99	-	T6	TP33	F-A, S-B	Category B. Clear of living quarters. Toxic if swallowed, by skin contact or by inhalation. Causes burns to skin, eyes and mucous membranes.	2928
2928	TOXIC SOLID, CORROSIVE, ORGANIC, N.O.S.	6.1	8	II	274	500 g	E4	P002	-	IBC06	B2	T3	TP33	F-A, S-B	Category B. Clear of living quarters. See entry above.	2928
2929	TOXIC LIQUID, FLAMMABLE, ORGANIC, N.O.S.	6.1	3	I	274 315	0	E5	P001	-	-	-	T14	TP2 TP13 TP27	F-E, S-D	Category B. Clear of living quarters. Toxic if swallowed, by skin contact or by inhalation.	2929
2929	TOXIC LIQUID, FLAMMABLE, ORGANIC, N.O.S.	6.1	3	II	274	100 ml	E4	P001	-	IBC02	-	T11	TP2 TP13 TP27	F-E, S-D	Category B. Clear of living quarters. See entry above.	2929
2930	TOXIC SOLID, FLAMMABLE, ORGANIC, N.O.S.	6.1	4.1	I	274	0	E5	P002	-	IBC99	-	T6	TP33	F-A, S-C	Category B. Toxic if swallowed, by skin contact or by inhalation.	2930
2930	TOXIC SOLID, FLAMMABLE, ORGANIC, N.O.S.	6.1	4.1	II	274	500 g	E4	P002	-	IBC08	B2 B4	T3	TP33	F-A, S-C	Category B. See entry above.	2930

UN No. (1)	PSN (2)	Class No. (3)	Subsidiary Risk(s) (4)	Packing Group (5)	Special Provisions (6)	Limited quantities (7a)	Excepted quantities (7b)	Packing		IBC		UN No. (18)	Properties and Observations (17)
								Instruc-tions (8)	Provisions (9)	Instruc-tions (10)	Provisions (11)		
2931	VANADYL SULPHATE	6.1	-	II	-	500 g	E4	P002	-	IBC08	B2 B4	2931	Blue, crystalline powder. Soluble in water. Toxic if swallowed, by skin contact or by dust inhalation.
2933	METHYL 2-CHLOROPROPIONATE	3	-	III	-	5 l	E1	R001 LP01	-	IBC03	-	2933	Colourless liquid with an etheric, like odour. Flashpoint: 32°C c.c. Slightly soluble in water. Irritating to skin, eyes and mucous membranes.
2934	ISOPROPYL 2-CHLOROPROPIONATE	3	-	III	-	5 l	E1	R001 LP01	-	IBC03	-	2934	Colourless liquid with a sweetish odour. Flashpoint: 50°C c.c. Immiscible with water. Irritating to skin, eyes and mucous membranes.
2935	ETHYL 2-CHLOROPROPIONATE	3	-	III	-	5 l	E1	P001 LP01	-	IBC03	-	2935	Colourless liquid with a pungent odour. Flashpoint: 38°C c.c. Immiscible with water. Irritating to skin, eyes and mucous membranes.
2936	THIOLACTIC ACID	6.1	-	II	-	100 ml	E4	P001	-	IBC02	-	2936	Oily liquid with a foul odour. Melting point: 10°C. Miscible with water. Toxic if swallowed, by skin contact or by inhalation.
2937	alpha-METHYLBENZYL ALCOHOL, LIQUID	6.1	-	III	-	5 l	E1	P001 LP01	-	IBC03	-	2937	Colourless liquid. Slightly miscible with water. Melting point: 21°C (pure substance). Toxic if swallowed, by skin contact or by inhalation.
2940	9-PHOSPHORIBICLONAMAMES (CYCLODIADENE PHOSPHINES)	4.2	-	II	-	0	E2	P410 PP3	IBC06	B2	2940	Colourless, waxy solids. Melting point: 40°C to 60°C. React in contact with water to form a white solid. On contact with water, there is a strong charring and evolution of toxic fumes. Irritating to skin, eyes and mucous membranes.	
2941	FLUORANILINES	6.1	-	III	-	5 l	E1	P001 LP01	-	IBC03	-	2941	Liquids. Freezing points: -28°C to -2°C. Immiscible with water. Toxic if swallowed, by skin contact or by inhalation.
2942	2-TRIFLUOROMETHYLAMINE	6.1	-	III	-	5 l	E1	P001 LP01	-	IBC03	-	2942	Liquid. Immiscible with water. Toxic if swallowed, by skin contact or by inhalation.
2943	TETRAHYDROFURYLAMINE	3	-	III	-	5 l	E1	P001 LP01	-	IBC03	-	2943	Colourless to yellowish liquid with an ammoniacal odour. Flashpoint: 45°C c.c. Miscible with water. Harmful by inhalation. Irritating to skin, eyes and mucous membranes.
2945	N-METHYL BUTYLAMINE	3	8	II	-	1 l	E2	P001	-	IBC02	-	2945	Colourless liquid. Flashpoint: 0°C c.c. Miscible with water. Harmful by inhalation. Causes burns to skin and eyes. Irritating to mucous membranes.
2946	2-AMINO-5-DIETHYLAMINOPENTANE	6.1	-	III	-	5 l	E1	R001 LP01	-	IBC03	-	2946	Liquid with an acid odour. Miscible with water. Toxic if swallowed, by skin contact or by inhalation.
2947	ISOPROPYL CHLOROACETATE	3	-	III	-	5 l	E1	P001 LP01	-	IBC03	-	2947	Colourless liquid with a pungent odour. Flashpoint: 56°C c.c. Slightly soluble in water. Harmful by inhalation. Irritating to skin, eyes and mucous membranes.
2948	3-TRIFLUOROMETHYLAMINE	6.1	-	II	-	100 ml	E4	P001	-	IBC02	-	2948	Colourless to yellowish liquid. Melting point: 3°C. Slightly miscible with water. Toxic if swallowed, by skin contact or by inhalation.
2949	SODIUM HYDROSULPHIDE, HYDRATED 25% water of crystallization	8	-	II	-	1 kg	E2	P002	-	IBC08	B2 B4	2949	Colourless needles or yellow flakes. Soluble in water with a foul odour. Melting point: 32°C. Reacts violently with acids, evolving hydrogen sulphide gas. Harmful by inhalation. Causes burns to skin, eyes and mucous membranes.
2950	MAGNESIUM GRANULES, COATED with less than 149 microns	4.3	-	III	920	1 kg	E1	P410	-	IBC08	B4	2950	Coated granules with particle size ranging from 149 to 250 microns. In contact with water or acids, evolve hydrogen, a flammable gas.

**TSFS 2015:66  
Bilaga 1**

UN No. (1)	PSN (2)	Class No. (3)	Subsidiary Risk(s) (4)	Packing Group (5)	Special Provisions (6)	Limited quantities (7a)	Excluded quantities (7b)	Packing		IBC		Tank instructions (15)	Provisions (14)	Ems (15)	Stowage and Segregation (16)	Properties and Observations (17)	UN No. (18)
								Instruc-tions (8)	Provisions (9)	Instruc-tions (10)	Provisions (11)						
2956	5-tert-BUTYL-2,4,6-TRINITRO-m-XYLENE (MIXTURE)	4.1	-	III	133	0	E1	P409	-	-	-	-	-	F-B, S-C	Category D. Protected from sources of ignition. Inert. Insoluble in water. May explode if involved in a fire under confined conditions. May be highly sensitive to strong detonation shock. Harmful if swallowed or by skin contact.	2956	
2965	BORON TRIFLUORIDE DIMETHYLETHERATE	4.3	3/8	I	-	0	E0	P401	PP31	-	-	T10	TP2 TP7 TP13	F-G, S-O	Category D. Clear of living quarters. Segregation as for Class 3, but "Away from" classes 3, 4.1 and 8.	2965	
2966	THIOGLYCOL	6.1	-	II	-	100 ml	E4	P001	-	IBC02	-	T7	TP2	F-A, S-A	Category A.	2966	
2967	SULPHAMIC ACID	8	-	III	-	5 kg	E1	P002 LP02	-	IBC08 B3	-	T1	TP33	F-A, S-B	Category A.	2967	
2968	MANEB, STABILIZED or MANEB PREPARATION, STABILIZED against self-heating	4.3	P	III	223 946	1 kg	E1	P002	-	IBC08 B4	-	T1	TP33	F-C, S-L	Category B. Segregation from foodstuffs as in 7.3.4.2.2, 7.3.1.2 or 7.7.3.7. "Separated from" acids.	2968	
2969	CASTOR BEANS or CASTOR MEAL or CASTOR POMACE or CASTOR FLAKE	9	-	II	141	5 kg	E2	P002	PP34	IBC08 B2 B4	-	T3 BK2	TP33	F-A, S-A	Category E. Clear of living quarters. Segregation from foodstuffs as in 7.3.4.2.2, 7.3.1.2 or 7.7.3.7. "Separated from" foodstuffs as in 7.3.1.2 or 7.7.3.7. "Separated from" Class 6.2.	2969	
2977	RADIOACTIVE MATERIAL, URANIUM HEXAFLUORIDE, FISSILE	7	8	-	172	0	E0	See 4.1.1.9	See 4.1.1.9	See 4.1.1.9	See 4.1.1.9	-	-	E-L, S-S	Category A, taking account of any supplementary requirements specified in the transport documents.	2977	
2978	RADIOACTIVE MATERIAL, URANIUM HEXAFLUORIDE non fissile or fissile-excepted	7	8	-	172 317	0	E0	See 4.1.1.9	See 4.1.1.9	See 4.1.1.9	See 4.1.1.9	-	-	E-L, S-S	Category A, taking account of any supplementary requirements specified in the transport documents.	2978	
2983	ETHYLENE OXIDE AND PROPYLENE OXIDE MIXTURE with not more than 30% ethylene oxide	3	6.1	I	-	0	E0	P200	-	-	-	T14	TP2 TP3	F-E, S-D	Category E. Clear of living quarters.	2983	
2984	HYPOCHLORITE AQUEOUS SOLUTION with not less than 5% but less than 20% hydrogen peroxide (stabilized as necessary)	5.1	-	III	65	5 l	E1	P504	-	IBC02 B5	-	T4	TP1 TP6 TP24	F-H, S-Q	Category B. Protected from sources of ignition. Corrosive to metals, except permanganates and class 4.1. See 7.2.6.3.2.	2984	
2985	CHLOROSILANES, FLAMMABLE, CORROSIVE, N.O.S.	3	8	II	-	0	E0	P010	-	-	-	T14	TP2 TP7 TP13 TP27	F-E, S-C	Category B. Clear of living quarters.	2985	
2986	CHLOROSILANES, CORROSIVE, FLAMMABLE, N.O.S.	8	3	II	-	0	E0	P010	-	-	-	T14	TP2 TP3 TP27	F-E, S-C	Category C. Clear of living quarters.	2986	

UN No. (1)	PSN (2)	Class No. (3)	Subsidiary Risk(s) (4)	Packing Group (5)	Special Provisions (6)	Limited quantities (7a)	Excepted quantities (7b)	Packing			IBC	
								Instruc-tions (8)	Provisions (9)	Instruc-tions (10)	Provisions (11)	
3.1.2		2.0	2.0	2.0	1.3	3.3	3.4	3.5	4.1, 4	4.1, 4	4.1, 4	
8				II			EO	P010				

UN No. (16)	Properties and Observations (17)
2987	Colourless liquids with a pungent odour. Immiscible with water. Reacts with water to produce white fumes. When involved in a fire, evolve toxic gases. In the presence of moisture, highly corrosive to most metals. Cause burns to skin, eyes and mucous membranes.

UN No. (16)	Properties and Observations (17)
2988	Colourless, very volatile liquids, flammable and corrosive, with a pungent odour. Immiscible with water. React violently with water or steam to produce heat which may lead to self-ignition; toxic and corrosive fumes. Cause burns to skin, eyes and mucous membranes.

UN No. (16)	Properties and Observations (17)
2989	Fine white crystals or powder. Insoluble in water. Combustion can be sustained, even in the absence of air. Harmful if swallowed.

UN No. (16)	Properties and Observations (17)
2989	See entry above.

UN No. (16)	Properties and Observations (17)
2990	These articles may contain: (a) Batteries; (b) Signal devices (Class 1) which may include smoke and illumination signal flares; signal devices must be packed in plastic of fibreboard inner packaging; (c) Electric storage batteries; (d) Electric storage batteries; (e) Strike anywhere matches.

UN No. (16)	Properties and Observations (17)
2991	Liquid flammable pesticides having a flashpoint between 23°C and 60°C c.c., presenting a very wide range of toxic hazard. They frequently contain petroleum or coal tar distillates, or other flammable liquids. Flashpoint and miscibility with water depend upon the composition. Toxic if swallowed, by skin contact or by inhalation.

UN No. (16)	Properties and Observations (17)
2991	See entry above.

UN No. (16)	Properties and Observations (17)
2991	See entry above.

UN No. (16)	Properties and Observations (17)
2991	See entry above.

UN No. (16)	Properties and Observations (17)
2991	See entry above.

UN No. (16)	Properties and Observations (17)
2992	Miscibility with water depends upon the composition. Toxic if swallowed, by skin contact or by inhalation.

UN No. (16)	Properties and Observations (17)
2992	See entry above.

UN No. (16)	Properties and Observations (17)
2992	See entry above.

UN No. (16)	Properties and Observations (17)
2992	See entry above.

UN No. (16)	Properties and Observations (17)
2993	Liquid flammable pesticides having a flashpoint between 23°C and 60°C c.c., presenting a very wide range of toxic hazard. They frequently contain petroleum or coal tar distillates, or other flammable liquids. Flashpoint and miscibility with water depend upon the composition. Toxic if swallowed, by skin contact or by inhalation.

UN No. (16)	Properties and Observations (17)
2993	See entry above.

UN No. (16)	Properties and Observations (17)
2993	See entry above.

# TSFS 2015:66 Bilaga 1

UN No. (1)	PSN (2)	Class or Div. (3)	Subsidiary Risk(s) (4)	Packing Group (5)	Special Provisions (6)	Limited quantities (7a)	Excepted quantities (7b)	Packing			IBC		
								Class or Div. (5)	Instruc-tions (8)	Provisions (9)	Instruc-tions (10)	Provisions (11)	
3.1.2		2.0	2.0	2.0	1.3	3.3	3.4	3.5	4.1, 4	4.1, 4	4.1, 4	4.1, 4	
2993	ARSENICAL PESTICIDE, LIQUID, TOXIC, FLAMMABLE, flashpoint not less than 23°C	6.1	-	III		6.1	5 ℓ	E1	P001	-	IBC03	-	2993
2994	ARSENICAL PESTICIDE, LIQUID, TOXIC	6.1	-	I		6.1	0	E5	P001	-		-	2994
2994	ARSENICAL PESTICIDE, LIQUID, TOXIC	6.1	-	II		6.1	100 ml	E4	P001	-	IBC02	-	2994
2994	ARSENICAL PESTICIDE, LIQUID, TOXIC	6.1	-	III		6.1	5 ℓ	E1	P001	-	IBC03	-	2994
2995	ORGANOCHLORINE PESTICIDE, LIQUID, TOXIC, FLAMMABLE, flashpoint not less than 23°C	6.1	3	I		6.1	0	E5	P001	-		-	2995
2995	ORGANOCHLORINE PESTICIDE, LIQUID, TOXIC, FLAMMABLE, flashpoint not less than 23°C	6.1	3	II		6.1	100 ml	E4	P001	-	IBC02	-	2995
2995	ORGANOCHLORINE PESTICIDE, LIQUID, TOXIC, FLAMMABLE, flashpoint not less than 23°C	6.1	3	III		6.1	5 ℓ	E1	P001	-	IBC03	-	2995
2996	ORGANOCHLORINE PESTICIDE, LIQUID, TOXIC	6.1	-	I		6.1	0	E5	P001	-		-	2996
2996	ORGANOCHLORINE PESTICIDE, LIQUID, TOXIC	6.1	-	II		6.1	100 ml	E4	P001	-	IBC02	-	2996
2996	ORGANOCHLORINE PESTICIDE, LIQUID, TOXIC	6.1	-	III		6.1	5 ℓ	E1	P001	-	IBC03	-	2996
2997	TRIAZINE PESTICIDE, LIQUID, TOXIC, FLAMMABLE, flashpoint not less than 23°C	6.1	3	I		6.1	0	E5	P001	-		-	2997
2997	TRIAZINE PESTICIDE, LIQUID, TOXIC, FLAMMABLE, flashpoint not less than 23°C	6.1	3	II		6.1	100 ml	E4	P001	-	IBC02	-	2997
2997	TRIAZINE PESTICIDE, LIQUID, TOXIC, FLAMMABLE, flashpoint not less than 23°C	6.1	3	III		6.1	5 ℓ	E1	P001	-	IBC03	-	2997

UN No. (1)	PSN (2)	Class or Div. (3)	Subsidiary Risk(s) (4)	Packing Group (5)	Special Provisions (6)	Limited quantities (7a)	Excepted quantities (7b)	Packaging			Properties and Observations (17)
								Class or Div. (3)	Instruc-tions (8)	Provisions (9)	
4.2.5		4.2.5	4.3	4.3	7.8	7.1	7.7				
2994	Category A. Clear of living quarters. See entry above.	T7	TP2	TP28	F-E, S-D						2994
2994	Category B. Clear of living quarters. See entry above.	T14	TP2	TP13	F-A, S-A						2994
2994	Category B. Clear of living quarters. See entry above.	T11	TP2	TP13	F-A, S-A						2994
2994	Category A. Clear of living quarters. See entry above.	T7	TP2	TP28	F-A, S-A						2994
2995	Category B. Clear of living quarters. See entry above.	T14	TP2	TP13	F-E, S-D						2995
2995	Category A. Clear of living quarters. See entry above.	T7	TP2	TP28	F-E, S-D						2995
2996	Category B. Clear of living quarters. See entry above.	T11	TP2	TP13	F-A, S-A						2996
2996	Category B. Clear of living quarters. See entry above.	T11	TP2	TP13	F-A, S-A						2996
2996	Category B. Clear of living quarters. See entry above.	T7	TP2	TP28	F-A, S-A						2996
2997	Category B. Clear of living quarters. See entry above.	T11	TP2	TP13	F-E, S-D						2997
2997	Category B. Clear of living quarters. See entry above.	T11	TP2	TP13	F-E, S-D						2997
2997	Category A. Clear of living quarters. See entry above.	T7	TP2	TP28	F-E, S-D						2997



UN No. (1)	PSN (2)	Class (3)	Subsidiary Risk(s) (4)	Packing Group (5)	Special Provisions (6)	Limited quantities (7a)	Excepted quantities (7b)	Packing			IBC	
								Instruc-tions (8)	Provisions (9)	Instruc-tions (10)	Provisions (11)	
3.1.2		2.0	2.0	2.0, 1.3	3.3	3.4	3.5	4.1, 4	4.1, 4	4.1, 4	4.1, 4	
2998	TRIAZINE PESTICIDE, LIQUID, TOXIC	6.1	-	I	61, 274	0	E5	P001	-	-	-	2998

UN No. (18)	Properties and Observations (17)	Storage and Segregation (16)	Portable tanks and bulk containers	
			Tank instructions (15)	Provisions (14)
		7.1 to 7.7	4.2.5, 4.3	4.2.5
2998	Category B. Clear of living quarters. See alphabetical index to identify those pesticides which are marine pollutants. Miscibility with water depends upon the composition. Toxic if swallowed, by skin contact or by inhalation.		TP2, TP3, TP7, TP27	F-A, S-A

2998	TRIAZINE PESTICIDE, LIQUID, TOXIC	6.1	-	II	61, 274	100 ml	E4	P001	-	IBC02	-	2998
2998	TRIAZINE PESTICIDE, LIQUID, TOXIC	6.1	-	III	61, 223, 274	5 l	E1	P001, LP01	-	IBC03	-	2998

3005	THIOCARBAMATE PESTICIDE, LIQUID, TOXIC, FLAMMABLE, flashpoint not less than 23°C	6.1	3	I	61, 274	0	E5	P001	-	-	-	3005
3005	THIOCARBAMATE PESTICIDE, LIQUID, TOXIC, FLAMMABLE, flashpoint not less than 23°C	6.1	3	II	61, 274	100 ml	E4	P001	-	IBC02	-	3005

3005	THIOCARBAMATE PESTICIDE, LIQUID, TOXIC, FLAMMABLE, flashpoint not less than 23°C	6.1	3	III	61, 223, 274	5 l	E1	P001	-	IBC03	-	3005
------	--	-----	---	-----	--------------	-----	----	------	---	-------	---	------

3006	THIOCARBAMATE PESTICIDE, LIQUID, TOXIC	6.1	-	I	61, 274	0	E5	P001	-	-	-	3006
------	--	-----	---	---	---------	---	----	------	---	---	---	------

3006	THIOCARBAMATE PESTICIDE, LIQUID, TOXIC	6.1	-	II	61, 274	100 ml	E4	P001	-	IBC02	-	3006
------	--	-----	---	----	---------	--------	----	------	---	-------	---	------

3006	THIOCARBAMATE PESTICIDE, LIQUID, TOXIC	6.1	-	III	61, 223, 274	5 l	E1	P001, LP01	-	IBC03	-	3006
------	--	-----	---	-----	--------------	-----	----	------------	---	-------	---	------

3009	COPPER BASED PESTICIDE, LIQUID, TOXIC, FLAMMABLE, flashpoint not less than 23°C	6.1	3	I	61, 274	0	E5	P001	-	-	-	3009
------	---	-----	---	---	---------	---	----	------	---	---	---	------

3009	COPPER BASED PESTICIDE, LIQUID, TOXIC, FLAMMABLE, flashpoint not less than 23°C	6.1	3	II	61, 274	100 ml	E4	P001	-	IBC02	-	3009
------	---	-----	---	----	---------	--------	----	------	---	-------	---	------

3009	COPPER BASED PESTICIDE, LIQUID, TOXIC, FLAMMABLE, flashpoint not less than 23°C	6.1	3	III	61, 223, 274	5 l	E1	P001	-	IBC03	-	3009
------	---	-----	---	-----	--------------	-----	----	------	---	-------	---	------

3010	COPPER BASED PESTICIDE, LIQUID, TOXIC	6.1	-	I	61, 274	0	E5	P001	-	-	-	3010
------	---------------------------------------	-----	---	---	---------	---	----	------	---	---	---	------

**TSFS 2015:66  
Bilaga 1**

UN No. (1)	PSN (2)	Class or Div (5)	Subsidiary Risk(s) (4)	Packing Group (3)	Special Provisions (6)	Limited quantities (7a)	Excepted quantities (7b)	Packing			IBC			
								Instruc-tions (8)	Provisions (9)	Instruc-tions (10)	Provisions (11)			
	3.1.2	2.0	2.0	2.0, 1.3	3.3	3.4	3.5	4.1, 4	4.1, 4	4.1, 4				

Tank instructions (15)	Provisions (14)	EMs (15)	Stowage and Segregation (16)	Properties and Observations (17)	UN No. (18)

3010 COPPER BASED PESTICIDE, LIQUID, TOXIC 6.1 - II 61 100 ml E4 P001 - IBC02 - 3010 F-A, S-A Category B. Clear of living quarters. See entry above. TP2 TP28 TP27

3010 COPPER BASED PESTICIDE, LIQUID, TOXIC 6.1 - III 61 5 l E1 P001 LP01 - IBC03 - 3010 F-A, S-A Category A. Clear of living quarters. See entry above. TP2 TP28

3011 MERCURY BASED PESTICIDE, LIQUID, TOXIC, FLAMMABLE, flashpoint not less than 23°C 6.1 3 I 61 0 E5 P001 - - - - 3011 F-E, S-D Category B. Clear of living quarters. Liquid flammable pesticides having a flashpoint between 23°C and 60°C c.c., presenting a very wide range of toxic hazard. It frequently contains petroleum or coal tar distillates, or other flammable liquids. Flashpoint and miscibility with water depend upon the composition. Toxic if swallowed, by skin contact or by inhalation. TP2 TP13 TP27

3011 MERCURY BASED PESTICIDE, LIQUID, TOXIC, FLAMMABLE, flashpoint not less than 23°C 6.1 3 II 61 100 ml E4 P001 - IBC02 - 3011 F-E, S-D Category B. Clear of living quarters. See entry above. TP2 TP13 TP27

3011 MERCURY BASED PESTICIDE, LIQUID, TOXIC, FLAMMABLE, flashpoint not less than 23°C 6.1 3 III 61 5 l E1 P001 - IBC03 - 3011 F-E, S-D Category A. Clear of living quarters. See entry above. TP2 TP28

3012 MERCURY BASED PESTICIDE, LIQUID, TOXIC 6.1 - I 61 0 E5 P001 - - - - 3012 F-A, S-A Category B. Clear of living quarters. Liquid pesticides which present a very wide range of toxic hazard. Miscibility with water depends upon the composition. Toxic if swallowed, by skin contact or by inhalation. TP2 TP13 TP27

3012 MERCURY BASED PESTICIDE, LIQUID, TOXIC 6.1 - II 61 100 ml E4 P001 - IBC02 - 3012 F-A, S-A Category B. Clear of living quarters. See entry above. TP2 TP13 TP27

3012 MERCURY BASED PESTICIDE, LIQUID, TOXIC 6.1 - III 61 5 l E1 P001 LP01 - IBC03 - 3012 F-A, S-A Category A. Clear of living quarters. See entry above. TP2 TP28

3013 SUBSTITUTED NITROPHENOL PESTICIDE, LIQUID, TOXIC, FLAMMABLE, flashpoint not less than 23°C 6.1 3 I 61 274 0 E5 P001 - - - - 3013 F-E, S-D Category B. Clear of living quarters. Liquid flammable pesticides having a flashpoint between 23°C and 60°C c.c., presenting a very wide range of toxic hazard. They frequently contain petroleum or coal tar distillates, or other flammable liquids. Flashpoint and miscibility with water depend upon the composition. Toxic if swallowed, by skin contact or by inhalation. TP2 TP13 TP27

3013 SUBSTITUTED NITROPHENOL PESTICIDE, LIQUID, TOXIC, FLAMMABLE, flashpoint not less than 23°C 6.1 3 II 61 274 100 ml E4 P001 - IBC02 - 3013 F-E, S-D Category B. Clear of living quarters. See entry above. TP2 TP13 TP27

3013 SUBSTITUTED NITROPHENOL PESTICIDE, LIQUID, TOXIC, FLAMMABLE, flashpoint not less than 23°C 6.1 3 III 61 274 5 l E1 P001 - IBC03 - 3013 F-E, S-D Category A. Clear of living quarters. See entry above. TP2 TP28

3014 SUBSTITUTED NITROPHENOL PESTICIDE, LIQUID, TOXIC 6.1 - I 61 274 0 E5 P001 - - - - 3014 F-A, S-A Category B. Clear of living quarters. Liquid pesticides which present a very wide range of toxic hazard. Miscibility with water depends upon the composition. Toxic if swallowed, by skin contact or by inhalation. TP2 TP13 TP27

3014 SUBSTITUTED NITROPHENOL PESTICIDE, LIQUID, TOXIC 6.1 - II 61 100 ml E4 P001 - IBC02 - 3014 F-A, S-A Category B. Clear of living quarters. See entry above. TP2 TP13 TP27

UN No. (1)	PSN (2)	Class (3)	Subsidiary Risk(s) (4)	Packing Group (5)	Special Provisions (6)	Limited quantities (7a)	Excepted quantities (7b)	Packing			IBC	
								Class or Div (5)	Instruc-tions (8)	Provisions (9)	Instruc-tions (10)	Provisions (11)
	3.1.2	2.0	2.0	2.0	3.3	3.4	3.5	4.1.4	4.1.4	4.1.4	4.1.4	
		6.1	-	III	61 223 274	5 ℓ	E1	P001 LPO1	-	IBC03	-	

3014 SUBSTITUTED MITROPHENOL PESTICIDE, LIQUID, TOXIC  
Category A. Clear of living quarters. See entry above. 3014

3015 BIPYRIDILUM PESTICIDE, LIQUID, TOXIC, FLAMMABLE, flashpoint not less than 23°C  
Liquid flammable pesticides having a flashpoint between 23°C and 60°C c.c., presenting a very wide range of toxic hazard. They frequently contain petroleum or coal tar distillates, or other flammable liquids. Flashpoint and miscibility with water depend upon the composition. Toxic if swallowed, by skin contact or by inhalation. 3015

3015 BIPYRIDILUM PESTICIDE, LIQUID, TOXIC, FLAMMABLE, flashpoint not less than 23°C  
Category B. Clear of living quarters. See entry above. 3015

3015 BIPYRIDILUM PESTICIDE, LIQUID, TOXIC, FLAMMABLE, flashpoint not less than 23°C  
Category B. Clear of living quarters. See entry above. 3015

3015 BIPYRIDILUM PESTICIDE, LIQUID, TOXIC, FLAMMABLE, flashpoint not less than 23°C  
Category A. Clear of living quarters. See entry above. 3015

3015 BIPYRIDILUM PESTICIDE, LIQUID, TOXIC, FLAMMABLE, flashpoint not less than 23°C  
Category B. Clear of living quarters. See entry above. 3015

3016 BIPYRIDILUM PESTICIDE, LIQUID, TOXIC  
Miscibility with water depends upon the composition. Toxic if swallowed, by skin contact or by inhalation. 3016

3016 BIPYRIDILUM PESTICIDE, LIQUID, TOXIC  
Category A. Clear of living quarters. See entry above. 3016

3016 BIPYRIDILUM PESTICIDE, LIQUID, TOXIC  
Category B. Clear of living quarters. See entry above. 3016

3016 BIPYRIDILUM PESTICIDE, LIQUID, TOXIC  
Category A. Clear of living quarters. See entry above. 3016

3016 BIPYRIDILUM PESTICIDE, LIQUID, TOXIC  
Category B. Clear of living quarters. See entry above. 3016

3016 BIPYRIDILUM PESTICIDE, LIQUID, TOXIC  
Category A. Clear of living quarters. See entry above. 3016

3016 BIPYRIDILUM PESTICIDE, LIQUID, TOXIC  
Category B. Clear of living quarters. See entry above. 3016

3017 ORGANOPHOSPHORUS PESTICIDE, LIQUID, TOXIC, FLAMMABLE, flashpoint not less than 23°C  
Liquid flammable pesticides having a flashpoint between 23°C and 60°C c.c., presenting a very wide range of toxic hazard. They frequently contain petroleum or coal tar distillates, or other flammable liquids. Flashpoint and miscibility with water depend upon the composition. Toxic if swallowed, by skin contact or by inhalation. 3017

3017 ORGANOPHOSPHORUS PESTICIDE, LIQUID, TOXIC, FLAMMABLE, flashpoint not less than 23°C  
Category B. Clear of living quarters. See entry above. 3017

3017 ORGANOPHOSPHORUS PESTICIDE, LIQUID, TOXIC, FLAMMABLE, flashpoint not less than 23°C  
Category A. Clear of living quarters. See entry above. 3017

3017 ORGANOPHOSPHORUS PESTICIDE, LIQUID, TOXIC, FLAMMABLE, flashpoint not less than 23°C  
Category B. Clear of living quarters. See entry above. 3017

3018 ORGANOPHOSPHORUS PESTICIDE, LIQUID, TOXIC  
Liquid pesticides which present a very wide range of toxic hazard. Miscibility with water depends upon the composition. Toxic if swallowed, by skin contact or by inhalation. 3018

3018 ORGANOPHOSPHORUS PESTICIDE, LIQUID, TOXIC  
Category A. Clear of living quarters. See entry above. 3018

3018 ORGANOPHOSPHORUS PESTICIDE, LIQUID, TOXIC  
Category B. Clear of living quarters. See entry above. 3018

3018 ORGANOPHOSPHORUS PESTICIDE, LIQUID, TOXIC  
Category A. Clear of living quarters. See entry above. 3018

3018 ORGANOPHOSPHORUS PESTICIDE, LIQUID, TOXIC  
Category B. Clear of living quarters. See entry above. 3018

3018 ORGANOPHOSPHORUS PESTICIDE, LIQUID, TOXIC  
Category A. Clear of living quarters. See entry above. 3018

3018 ORGANOPHOSPHORUS PESTICIDE, LIQUID, TOXIC  
Category B. Clear of living quarters. See entry above. 3018

**TSFS 2015:66**  
**Bilaga 1**

UN No. (1)	PSN (2)	Class (3)	Subsidiary Risk(s) (4)	Packing Group (5)	Special Provisions (6)	Limited quantities (7a)	Excepted quantities (7b)	Packing			IBC		
								Class (3)	Subsidiary Risk(s) (4)	Packing Group (5)	Special Provisions (6)	Institutions (8)	Provisions (9)
	3.1.2	2.0	2.0	2.0, 1.3	3.3	3.4	3.5	4.1, 4	4.1, 4	4.1, 4	4.1, 4		
3019	ORGANOTIN PESTICIDE, LIQUID, TOXIC, FLAMMABLE, flashpoint not less than 23°C	6.1	3	I	61, 274	0	E5	P001	-	-	-		
3019	ORGANOTIN PESTICIDE, LIQUID, TOXIC, FLAMMABLE, flashpoint not less than 23°C	6.1	3	II	61, 274	100 ml	E4	P001	-	IBC02	-		
3019	ORGANOTIN PESTICIDE, LIQUID, TOXIC, FLAMMABLE, flashpoint not less than 23°C	6.1	3	III	61, 223, 274	5 l	E1	P001	-	IBC03	-		
3020	ORGANOTIN PESTICIDE, LIQUID, TOXIC	6.1	-	I	61, 274	0	E5	P001	-	-	-		
3020	ORGANOTIN PESTICIDE, LIQUID, TOXIC	6.1	-	II	61, 274	100 ml	E4	P001	-	IBC02	-		
3020	ORGANOTIN PESTICIDE, LIQUID, TOXIC	6.1	-	III	61, 223, 274	5 l	E1	P001, LP01	-	IBC03	-		
3021	PESTICIDE, LIQUID, FLAMMABLE, TOXIC, N.O.S. flashpoint less than 23°C	3	6.1	I	61, 274	0	E0	P001	-	-	-		
3021	PESTICIDE, LIQUID, FLAMMABLE, TOXIC, N.O.S. flashpoint less than 23°C	3	6.1	II	61, 274	1 l	E2	P001	-	IBC02	-		
3022	1,2-BUTYLENE OXIDE, STABILIZED	3	-	II	-	1 l	E2	P001	-	IBC02	-		
3023	2-METHYL-2-HEPTANETHOL	6.1	3	I	354	0	E0	P602	-	-	-		
3024	COUMARIN DERIVATIVE PESTICIDE, LIQUID, FLAMMABLE, TOXIC, flashpoint less than 23°C	3	6.1	I	61, 274	0	E0	P001	-	-	-		
3024	COUMARIN DERIVATIVE PESTICIDE, LIQUID, FLAMMABLE, TOXIC, flashpoint less than 25°C	3	6.1	II	61, 274	1 l	E2	P001	-	IBC02	-		
3025	COUMARIN DERIVATIVE PESTICIDE, LIQUID, TOXIC, FLAMMABLE, flashpoint not less than 23°C	6.1	3	I	61, 274	0	E5	P001	-	-	-		

UN No. (18)	Properties and Observations (17)	Storage and Segregation (16)	Portable tanks and bulk containers	
			Tank instructions (15)	Provisions (14)
		7.1 to 7.7	4.2.5, 4.3	4.2.5, 4.3
3019	Liquid flammable pesticides having a flashpoint between 23°C and 60°C c.c., presenting a very wide range of toxic hazard, per petroleum or coal tar distillates, or other flammable liquids. Flashpoint and miscibility with water depend upon the composition. Toxic if swallowed, by skin contact or by inhalation.		TP2, TP3, TP7, TP27	F-E, S-D
3019	Liquid flammable pesticides having a flashpoint between 23°C and 60°C c.c., presenting a very wide range of toxic hazard, per petroleum or coal tar distillates, or other flammable liquids. Flashpoint and miscibility with water depend upon the composition. Toxic if swallowed, by skin contact or by inhalation.		TP2, TP3, TP7, TP27	F-E, S-D
3019	Liquid flammable pesticides having a flashpoint between 23°C and 60°C c.c., presenting a very wide range of toxic hazard, per petroleum or coal tar distillates, or other flammable liquids. Flashpoint and miscibility with water depend upon the composition. Toxic if swallowed, by skin contact or by inhalation.		TP2, TP8	F-E, S-D
3020	Liquid pesticides which present a very wide range of toxic hazard. Miscibility with water depends upon the composition. Toxic if swallowed, by skin contact or by inhalation.		TP2, TP3, TP7, TP27	F-A, S-A
3020	Liquid pesticides which present a very wide range of toxic hazard. Miscibility with water depends upon the composition. See entry above.		TP2, TP3, TP7, TP27	F-A, S-A
3020	Liquid pesticides which present a very wide range of toxic hazard. Miscibility with water depends upon the composition. See entry above.		TP2, TP8	F-A, S-A
3021	Pesticides frequently contain petroleum or coal tar distillates, or other flammable liquids. Miscibility with water depends upon the composition. Toxic if swallowed, by skin contact or by inhalation.		TP2, TP3, TP7, TP27	F-E, S-D
3021	Pesticides frequently contain petroleum or coal tar distillates, or other flammable liquids. Miscibility with water depends upon the composition. See entry above.		TP2, TP3, TP7, TP27	F-E, S-D
3022	Colourless liquid. Flashpoint: -15°C c.c. Slightly acidic, alkaline and oxidizing. Miscible with water. Harmful if swallowed or by inhalation. Irritating to skin, eyes and mucous membranes.		TP1	F-E, S-D
3023	Colourless flammable liquid with a foul odour. Flashpoint: 31°C c.c. Miscible with water. Highly toxic if swallowed, by skin contact or by inhalation.		TP2, TP3, TP5	F-E, S-D
3024	Pesticides frequently contain petroleum or coal tar distillates, or other flammable liquids. Miscibility with water depends upon the composition. Toxic if swallowed, by skin contact or by inhalation.		TP2, TP3, TP7	F-E, S-D
3024	Pesticides frequently contain petroleum or coal tar distillates, or other flammable liquids. Miscibility with water depends upon the composition. See entry above.		TP2, TP3, TP7, TP27	F-E, S-D
3025	Liquid flammable pesticides having a flashpoint between 23°C and 60°C c.c., presenting a very wide range of toxic hazard. They frequently contain petroleum or coal tar distillates, or other flammable liquids. Flashpoint and miscibility with water depend upon the composition. Toxic if swallowed, by skin contact or by inhalation.		TP2, TP3, TP7, TP27	F-E, S-D

UN No. (1)	PSN (2)	Class or Div (5)	Subsidiary Risk(s) (4)	Packing Group (3)	Special Provisions (6)	Limited quantities (7a)	Excepted quantities (7b)	Packing		IBC		Portable tanks and bulk containers	EMS (15)	Storage and Segregation (16)	Properties and Observations (17)	UN No. (18)
								Instructions (8)	Provisions (9)	Instructions (10)	Provisions (11)					
3025	COU-MARIN DERIVATIVE PESTICIDE, LIQUID, TOXIC, FLAMMABLE flashpoint not less than 23°C	6.1	3	II	61 274	100 ml	E4	P001	-	IBC02	-	T11	F-E, S-D	Category B. Clear of living quarters. See entry above.		3025
3025	COU-MARIN DERIVATIVE PESTICIDE, LIQUID, TOXIC, FLAMMABLE flashpoint not less than 23°C	6.1	3	III	61 223 274	5 l	E1	P001	-	IBC03	-	T7	F-E, S-D	Category A. Clear of living quarters. See entry above.		3025
3026	COU-MARIN DERIVATIVE PESTICIDE, LIQUID, TOXIC	6.1	-	I	61 274	0	E5	P001	-	-	-	T14	F-A, S-A	Category B. Clear of living quarters. Liquid pesticides which present a very wide range of toxic hazard. Miscibility with water depends upon the composition. Toxic if swallowed, by skin contact or by inhalation.		3026
3026	COU-MARIN DERIVATIVE PESTICIDE, LIQUID, TOXIC	6.1	-	II	61 274	100 ml	E4	P001	-	IBC02	-	T11	F-A, S-A	Category B. Clear of living quarters. See entry above.		3026
3026	COU-MARIN DERIVATIVE PESTICIDE, LIQUID, TOXIC	6.1	-	III	61 223 274	5 l	E1	P001 LP01	-	IBC03	-	T7	F-A, S-A	Category A. Clear of living quarters. See entry above.		3026
3027	COU-MARIN DERIVATIVE PESTICIDE, SOLID, TOXIC	6.1	-	I	61 274	0	E5	P002	-	IBC07	B1	T6	F-A, S-A	Category A. Clear of living quarters. Solid pesticides present a very wide range of toxic hazard. Toxic if swallowed, by skin contact or by inhalation.		3027
3027	COU-MARIN DERIVATIVE PESTICIDE, SOLID, TOXIC	6.1	-	II	61 274	500 g	E4	P002	-	IBC08	B2 B4	T3	F-A, S-A	Category A. Clear of living quarters. See entry above.		3027
3027	COU-MARIN DERIVATIVE PESTICIDE, SOLID, TOXIC	6.1	-	III	61 223 274	5 kg	E1	P002 LP02	-	IBC08	B3	T1	F-A, S-A	Category A. Clear of living quarters. See entry above.		3027
3028	BATTERIES, DRY, CONTAINING POTASSIUM HYDROXIDE, SOLID electric storage	8	-	III	295 304	5 kg	E0	P801	-	-	-	-	F-A, S-B	Category A. "Separated from" acids. Series of metal plates immersed in dry potassium hydroxide in a closed receptacle. When electrically charged may cause fire through short-circuiting or terminals. Batteries need not be individually marked and may be transported for disposal or reclamation should be carefully checked prior to shipment to ensure the integrity of each battery and its suitability for transport. React violently with acids.		3028
3048	ALUMINIUM PHOSPHIDE PESTICIDE	6.1	-	I	153 930	0	E5	P002	PP31	IBC07	B1	T6	F-A, S-A	Category E. In a mechanically ventilated space. Clear of living quarters. Waxed pellets, adequately stabilized powder, tablets or crystals. Highly toxic if swallowed, by skin contact or by inhalation.		3048
3054	CYCLOHEXYL MEKCAPTAN	3	-	III	-	5 l	E1	P001 LP01	-	IBC03	-	T2	F-E, S-D	Category A. Clear of living quarters. Colourless, liquid with a specific, like odour. Flashpoint: 49°C. Immiscible with water. Harmful by inhalation. Irritating to skin, eyes and mucous membranes. Separated from odour-absorbing cargo.		3054
3055	2-(2-AMINOETHOXY) ETHANOL	8	-	III	-	5 l	E1	P001 LP01	-	IBC03	-	T4	F-A, S-B	Category A. Colourless, slightly viscous liquid with a mild odour. Miscible with water. Harmful if swallowed or by inhalation. Corrosive to skin, eyes and mucous membranes.		3055
3056	n-HEPTALDEHYDE	3	-	III	-	5 l	E1	P001 LP01	-	IBC03	-	T2	F-E, S-D	Category A. Colourless or pale yellow, oily liquid with a pungent odour. Flashpoint: 35°C to 45°C c.c. Explosive limits: 1.1% to 5.2%. Slightly soluble in water. Irritating to skin, eyes and mucous membranes.		3056
3057	TRIFLUOROACETYL CHLORIDE	2.3	8	-	-	0	E0	P200	-	-	-	T50	F-C, S-U	Category D. Clear of living quarters. Liquefied, non-flammable, toxic and corrosive gas. Reacts with water. Corrosive to skin, eyes and mucous membranes. Highly irritating to skin, eyes and mucous membranes. (1:4 at 20°C).		3057
3064	NITROGLYCERIN SOLUTION IN ALCOHOL with more than 1% but not more than 5% nitroglycerin	3	-	II	359	0	E0	P300	-	-	-	-	F-E, S-D	Category E. Immiscible with water. Ignites readily. When involved in a fire, evolves toxic nitrous fumes. Not explosive in this state but damage to, or leakage from, a package may allow solvent to evaporate and thus leave the nitroglycerin in an explosive state.		3064

UN No. (1)	PSN (2)	Class or Div (5)	Subsidiary Risk(s) (4)	Packing Group (3)	Special Provisions (6)	Limited quantities (7a)	Excepted quantities (7b)	Packing		IBC	
								Instruc-tions (8)	Provisions (9)	Instruc-tions (10)	Provisions (11)
3.1.2		2.0	2.0	2.0, 1.3	3.3	3.4	3.5	4.1, 4	4.1, 4	4.1, 4	4.1, 4

UN No. (18)	Properties and Observations (17)	Stowage and Segregation (16)	Portable tanks and bulk containers		Category A.
			Tank instructions (15)	Provisions (14)	
		7.1 to 7.7	4.2.5 4.3	4.2.5 7.8	F-E, S-D

3065 ALCOHOLIC BEVERAGES with more than 70% alcohol by volume  
 3065 ALCOHOLIC BEVERAGES with more than 24% alcohol but not more than 70% alcohol by volume  
 3065 ALCOHOLIC BEVERAGES with more than 24% alcohol but not more than 70% by volume, when transported as part of the manufacturing process, may be transported in wooden barrels with a capacity of more than 250 litres, provided that the following general requirements of 4.1.1.4, as appropriate, on the following conditions are met:  
 1. the wooden barrels should be checked and tightened before filling;  
 2. sufficient ullage (not less than 3%) should be left to allow for the expansion of the liquid;  
 3. the wooden barrels should be transported with the bungholes pointing upwards;  
 4. the wooden barrels should be transported in containers meeting the requirements of the International Convention for Safe Containers (CSC), as amended, and should be secured and braced in containers in such a manner and should be wedged by appropriate means to prevent them from being displaced in any way during transport; and  
 5. when carried on board ships, the containers should be stowed in open cargo spaces or in enclosed cargo spaces complying with the provisions of SOLAS, as amended, or less in regulation II-2/19 of SOLAS, 74, as amended.

UN No.	Description	Class	Packing	Special Provisions	Limited quantities	Excepted quantities	Instruc-tions	Provisions	IBC	Category
3065	ALCOHOLIC BEVERAGES with more than 24% alcohol but not more than 70% by volume, when transported as part of the manufacturing process, may be transported in wooden barrels with a capacity of more than 250 litres, provided that the following general requirements of 4.1.1.4, as appropriate, on the following conditions are met: 1. the wooden barrels should be checked and tightened before filling; 2. sufficient ullage (not less than 3%) should be left to allow for the expansion of the liquid; 3. the wooden barrels should be transported with the bungholes pointing upwards; 4. the wooden barrels should be transported in containers meeting the requirements of the International Convention for Safe Containers (CSC), as amended, and should be secured and braced in containers in such a manner and should be wedged by appropriate means to prevent them from being displaced in any way during transport; and 5. when carried on board ships, the containers should be stowed in open cargo spaces or in enclosed cargo spaces complying with the provisions of SOLAS, as amended, or less in regulation II-2/19 of SOLAS, 74, as amended.	3	-	II	-	5 l	P001	PP2	IBC02	-
3065	Alcoholic beverages containing more than 24% alcohol but not more than 70% by volume, when transported as part of the manufacturing process, may be transported in wooden barrels with a capacity of more than 250 litres, provided that the following general requirements of 4.1.1.4, as appropriate, on the following conditions are met: 1. the wooden barrels should be checked and tightened before filling; 2. sufficient ullage (not less than 3%) should be left to allow for the expansion of the liquid; 3. the wooden barrels should be transported with the bungholes pointing upwards; 4. the wooden barrels should be transported in containers meeting the requirements of the International Convention for Safe Containers (CSC), as amended, and should be secured and braced in containers in such a manner and should be wedged by appropriate means to prevent them from being displaced in any way during transport; and 5. when carried on board ships, the containers should be stowed in open cargo spaces or in enclosed cargo spaces complying with the provisions of SOLAS, as amended, or less in regulation II-2/19 of SOLAS, 74, as amended.	3	-	III	144 145 247	E1	P001	PP2	IBC03	-

3066 PAINT (including paint, lacquer, enamel, stain, shellac, varnish, polish, liquid filler and liquid lacquer base) or PAINT RELATED MATERIAL (including paint thinning or reducing compound)

UN No.	Description	Class	Packing	Special Provisions	Limited quantities	Excepted quantities	Instruc-tions	Provisions	IBC	Category
3066	PAINT (including paint, lacquer, enamel, stain, shellac, varnish, polish, liquid filler and liquid lacquer base) or PAINT RELATED MATERIAL (including paint thinning or reducing compound)	8	-	III	163 223	E1	P001	-	IBC03	-

3070 ETHYLENE OXIDE AND DICHLORO-DIFLUOROMETHANE MIXTURE with not more than 12.5% ethylene oxide

UN No.	Description	Class	Packing	Special Provisions	Limited quantities	Excepted quantities	Instruc-tions	Provisions	IBC	Category
3070	ETHYLENE OXIDE AND DICHLORO-DIFLUOROMETHANE MIXTURE with not more than 12.5% ethylene oxide	2.2	-	-	-	120 ml	E1	P200	-	-

3071 MERCAPTANS, LIQUID, TOXIC, FLAMMABLE, N.O.S. or MERCAPTAN MIXTURE, LIQUID, TOXIC, FLAMMABLE, N.O.S.

UN No.	Description	Class	Packing	Special Provisions	Limited quantities	Excepted quantities	Instruc-tions	Provisions	IBC	Category
3071	MERCAPTANS, LIQUID, TOXIC, FLAMMABLE, N.O.S. or MERCAPTAN MIXTURE, LIQUID, TOXIC, FLAMMABLE, N.O.S.	6.1	3	II	274	100 ml	E4	P001	IBC02	-

3072 LIFE-SAVING APPLIANCES, NOT SELF-INFLATING containing dangerous goods as equipment

UN No.	Description	Class	Packing	Special Provisions	Limited quantities	Excepted quantities	Instruc-tions	Provisions	IBC	Category
3072	LIFE-SAVING APPLIANCES, NOT SELF-INFLATING containing dangerous goods as equipment	9	-	-	296	0	E0	P905	-	-

3073 VINYLPIRIDINES, STABILIZED

UN No.	Description	Class	Packing	Special Provisions	Limited quantities	Excepted quantities	Instruc-tions	Provisions	IBC	Category
3073	VINYLPIRIDINES, STABILIZED	6.1	3/8	II	-	100 ml	E4	P001	IBC01	-

3077 ENVIRONMENTALLY HAZARDOUS SUBSTANCE, SOLID, N.O.S.

UN No.	Description	Class	Packing	Special Provisions	Limited quantities	Excepted quantities	Instruc-tions	Provisions	IBC	Category
3077	ENVIRONMENTALLY HAZARDOUS SUBSTANCE, SOLID, N.O.S.	9	-	III	274 356 967	5 kg	E1	P002 LP02	IBC08 B3	-

3078 CERUM turnings or gritty powder

UN No.	Description	Class	Packing	Special Provisions	Limited quantities	Excepted quantities	Instruc-tions	Provisions	IBC	Category
3078	CERUM turnings or gritty powder	4.3	-	II	-	500 g	E2	P410 PP1 PP40	IBC07 B2	-

3079 METHACRYLONITRILE, STABILIZED

UN No.	Description	Class	Packing	Special Provisions	Limited quantities	Excepted quantities	Instruc-tions	Provisions	IBC	Category
3079	METHACRYLONITRILE, STABILIZED	6.1	3	I	354	0	E0	P602	-	-

UN No. (1)	PSN (2)	Class (3)	Subsidiary Risk(s) (4)	Packing Group (5)	Special Provisions (6)	Limited quantities (7a)	Excepted quantities (7b)	Packing		IBC	
								Instruc-tions (8)	Provisions (9)	Instruc-tions (10)	Provisions (11)
3.1.2		2.0	2.0	2.0, 1.3	3.3	3.4	3.5	4.1, 4	4.1, 4	4.1, 4	

Portable tanks and bulk containers	
Tank instructions (15)	Provisions (14)
4.2.5 4.3	4.2.5

UN No. (16)	Properties and Observations (17)	Stowage and Segregation (16)	EMs (15)	Portable tanks and bulk containers	
				Tank instructions (15)	Provisions (14)
		7.1 to 7.7	5.4, 5.2 7.8	4.2.5	4.3

3080	ISOCYANATES, TOXIC, FLAMMABLE, N.O.S. or ISOCYANATE SOLUTION, TOXIC, FLAMMABLE, N.O.S.	6.1	3	II	274	100 mf	E4	P001	-	IBC02	-	T11	TP2 TP29	F-E, S-D	Category D. Flammable liquids or solutions with a pungent odour, immiscible with or swollen by, by skin contact or by inhalation. Irritating to skin, eyes and mucous membranes.	3080
3082	ENVIRONMENTALLY HAZARDOUS SUBSTANCE, LIQUID, N.O.S.	9	-	III	274 335	5 l	E1	P001 LP01	IBC03	-	-	T4	TP2 TP29	F-A, S-F	Category A.	3082
3083	PERCHLORYL FLUORIDE	2.3	5.1	-	-	0	E0	P200	-	-	-	-	-	F-C, S-W	Category D. Clear of living quarters. Non-flammable, toxic, colourless gas with a characteristic sweet odour. Strong oxidizing agent; may cause fire in contact with organic materials. Reacts with water or moist air to produce toxic and corrosive fumes. Mixtures with oils or combustible materials may explode. Much heavier than air (3.6). Irritating to skin, eyes and mucous membranes. Causes burns to skin, eyes and mucous membranes.	3083
3084	CORROSIVE SOLID, OXIDIZING, N.O.S.	8	5.1	I	274	0	E0	P002	-	-	-	T6	TP33	F-A, S-Q	Category C.	3084
3084	CORROSIVE SOLID, OXIDIZING, N.O.S.	8	5.1	II	274	1 kg	E2	P002	-	IBC06	B2	T3	TP33	F-A, S-Q	Category C.	3084
3085	OXIDIZING SOLID, CORROSIVE, N.O.S.	5.1	8	I	274	0	E0	P503	-	-	-	-	-	F-A, S-Q	Category D. Keep as dry as reasonably practicable. "Separated from" ammonium compounds, cyanides and peroxides.	3085
3085	OXIDIZING SOLID, CORROSIVE, N.O.S.	5.1	8	II	274	1 kg	E2	P002	-	IBC06	B2	T3	TP33	F-A, S-Q	Category B. Keep as dry as reasonably practicable. "Separated from" ammonium compounds, cyanides and peroxides.	3085
3085	OXIDIZING SOLID, CORROSIVE, N.O.S.	5.1	8	III	223 274	5 kg	E1	P002	-	IBC08	B3	T1	TP33	F-A, S-Q	Category B. Keep as dry as reasonably practicable. "Separated from" ammonium compounds, cyanides and peroxides.	3085
3086	TOXIC SOLID, OXIDIZING, N.O.S.	6.1	5.1	I	274	0	E5	P002	-	-	-	T6	TP33	F-A, S-Q	Category C.	3086
3086	TOXIC SOLID, OXIDIZING, N.O.S.	6.1	5.1	II	274	500 g	E4	P002	-	IBC06	B2	T3	TP33	F-A, S-Q	Category C.	3086
3087	OXIDIZING SOLID, TOXIC, N.O.S.	5.1	6.1	I	274, 900	0	E0	P503	-	-	-	-	-	F-A, S-Q	Category D. "Separated from" ammonium compounds, cyanides and peroxides.	3087
3087	OXIDIZING SOLID, TOXIC, N.O.S.	5.1	6.1	II	274, 900	1 kg	E2	P002	-	IBC06	B2	T3	TP33	F-A, S-Q	Category B. "Separated from" ammonium compounds, cyanides and peroxides.	3087
3087	OXIDIZING SOLID, TOXIC, N.O.S.	5.1	6.1	III	223 274, 900	5 kg	E1	P002	-	IBC08	B3	T1	TP33	F-A, S-Q	Category B. "Separated from" ammonium compounds, cyanides and peroxides.	3087
3088	SELF-HEATING SOLID, ORGANIC, N.O.S.	4.2	-	II	274	0	E2	P410	PP31	IBC06	B2	T3	TP33	F-A, S-J	Category C.	3088
3088	SELF-HEATING SOLID, ORGANIC, N.O.S.	4.2	-	III	223 274	0	E1	P002 LP02	PP31	IBC08	B3	T1	TP33	F-A, S-J	Category C.	3088
3089	METAL POWDER, FLAMMABLE, N.O.S.	4.1	-	II	-	1 kg	E2	P002	-	IBC08	B2 B4	T3	TP33	F-G, S-C	Category B. "Separated from" class 5.1.	3089

**TSFS 2015:66**  
**Bilaga 1**

UN No. (1)	PSN (2)	Class or Div (3)	Subsidiary Risk(s) (4)	Packing Group (5)	Special Provisions (6)	Limited quantities (7a)	Excepted quantities (7b)	Packing			IBC			Provisions (11)	Properties and Observations (17)	UN No. (18)
								Class (8)	Subsidiary Risk(s) (9)	Instructions (10)	Institutions (10)	Provisions (10)	Institutions (10)			
	3.1.2	2.0	2.0	2.0, 1.3	3.3	3.4	3.5	4.1, 4	4.1, 4	4.1, 4						
3089	METAL POWDER, FLAMMABLE, N.O.S.	4.1	-	III	223	5 kg	EI	P002	-	IBC06	-	-	-	Category A. "Separated from" class 5.1.	F-G, S-G	3089
3090	LITHIUM METAL BATTERIES (including lithium alloy batteries)	9	-	II	188 230 310 357	0	ED	P903	-	-	-	-	Category A.	Electrical batteries containing lithium encased in a rigid metallic body. Lithium batteries may also be shipped in, or packed with, equipment. Electrical lithium batteries may cause fire due to an explosive rupture of the body caused by improper construction or reaction with contaminants.	F-A, S-I	3090
3091	LITHIUM METAL BATTERIES CONTAINED IN EQUIPMENT	9	-	II	188 230 310 357	0	ED	P903	-	-	-	-	Category A.	See above	F-A, S-I	3091
3092	LITHIUM METAL BATTERIES PACKED WITH EQUIPMENT (including lithium alloy batteries)	3	-	III	-	5 ℓ	EI	P001 LP01	-	IBC03	-	T2	TP1	Category A.	F-E, S-D	3092
3093	CORROSIVE LIQUID, OXIDIZING, N.O.S.	8	5.1	I	274	0	ED	P001	-	-	-	-	-	Category C.	F-A, S-Q	3093
3093	CORROSIVE LIQUID, OXIDIZING, N.O.S.	8	5.1	II	274	1 ℓ	E2	P001	-	IBC02	-	-	-	Category C.	F-A, S-Q	3093
3094	CORROSIVE LIQUID, WATER-REACTIVE, N.O.S.	8	4.3	I	274	0	ED	P001	-	-	-	-	-	Category D.	F-G, S-L	3094
3094	CORROSIVE LIQUID, WATER-REACTIVE, N.O.S.	8	4.3	II	274	500 ml	E2	P001	-	-	-	-	-	Category D.	F-G, S-L	3094
3095	CORROSIVE SOLID, SELF-HEATING, N.O.S.	8	4.2	I	274	0	ED	P002	-	-	-	T6	TP33	Category D.	F-A, S-N	3095
3095	CORROSIVE SOLID, SELF-HEATING, N.O.S.	8	4.2	II	274	1 kg	E2	P002	-	IBC06	B2	T3	TP33	Category D.	F-A, S-N	3095
3096	CORROSIVE SOLID, WATER-REACTIVE, N.O.S.	8	4.3	I	274	0	ED	P002	-	-	-	T6	TP33	Category D.	F-G, S-L	3096
3096	CORROSIVE SOLID, WATER-REACTIVE, N.O.S.	8	4.3	II	274	1 kg	E2	P002	-	IBC06	B2	T3	TP33	Category D.	F-G, S-L	3096
3097	FLAMMABLE SOLID, OXIDIZING, N.O.S.	4.1	5.1	II	76 274	0	E2	P099	-	-	-	T2	-	-	F-A, S-Q	3097
3097	FLAMMABLE SOLID, OXIDIZING, N.O.S.	4.1	5.1	III	76 274	0	E1	P099	-	-	-	TI	TP33	-	F-A, S-Q	3097
3098	OXIDIZING LIQUID, CORROSIVE, N.O.S.	5.1	8	I	274	0	ED	P502	-	-	-	-	-	Category D. Keep as dry as reasonably practicable. "Separated from" ammonium compounds, cyanides and peroxides.	F-A, S-Q	3098
3098	OXIDIZING LIQUID, CORROSIVE, N.O.S.	5.1	8	II	274	1 ℓ	E2	P504	-	IBC01	-	-	-	See entry above. Category B. Keep as dry as reasonably practicable. "Separated from" ammonium compounds, cyanides and peroxides.	F-A, S-Q	3098
3098	OXIDIZING LIQUID, CORROSIVE, N.O.S.	5.1	8	III	223 274	5 ℓ	E1	P504	-	IBC02	-	-	-	See entry above. Category B. Keep as dry as reasonably practicable. "Separated from" ammonium compounds, cyanides and peroxides.	F-A, S-Q	3098



UN No. (1)	PSN (2)	Class No. (3)	Subsidiary Risk(s) (4)	Packing Group (5)	Special Provisions (6)	Limited quantities (7a)	Excepted quantities (7b)	Packing		IBC		EMs (15)	Stowage and Segregation (16)	Properties and Observations (17)	UN No. (18)
								Institutions (8)	Provisions (9)	Institutions (10)	Provisions (11)				
	3.1.2	2.0	2.0	2.0.1.3	3.3	3.4	3.5	4.1.4	4.1.4	4.1.4	4.1.4	4.2.5 4.3	7.1 to 7.7		
3099	OXIDIZING LIQUID, TOXIC, N.O.S.	5.1	6.1	I	274	0	EO	P502	-	-	-	F-A, S-Q	Category D. "Separated from" acids, cyanides, cyanides, cyanides and peroxides.	Toxic, if swallowed, by skin contact or by dust inhalation. Should be handled with care to minimize exposure, particularly to dust.	3099
3099	OXIDIZING LIQUID, TOXIC, N.O.S.	5.1	6.1	II	274	1 ℓ	E2	P504	-	IBC01	-	F-A, S-Q	Category B. "Separated from" ammonium compounds, cyanides and peroxides.	See entry above.	3099
3099	OXIDIZING LIQUID, TOXIC, N.O.S.	5.1	6.1	III	274	5 ℓ	E1	P504	-	IBC02	-	F-A, S-Q	Category B. "Separated from" ammonium compounds, cyanides and peroxides.	See entry above.	3099
3100	OXIDIZING SOLID, SELF-HEATING, N.O.S.	5.1	4.2	I	76	0	EO	P099	-	-	-	F-A, S-Q	-	-	3100
3100	OXIDIZING SOLID, SELF-HEATING, N.O.S.	5.1	4.2	II	76	0	E2	P099	-	-	-	F-A, S-Q	-	-	3100
3101	ORGANIC PEROXIDE TYPE B, LIQUID	5.2	See SPI81	-	122 181 195 274	25 ml	EO	P520	-	-	-	F-J, S-R	Category D. For packages carrying a subsidiary risk label of class 1, segregation as for class 1.3. "Separated from acids and alkalis. Protected from sources of heat."	May explode at elevated temperatures or in a fire. Burns vigorously. Immiscible with water. Contact with the eyes and skin should be avoided. May evolve irritant or toxic fumes.	3101
3102	ORGANIC PEROXIDE TYPE B, SOLID	5.2	See SPI81	-	122 181 195 274	100 g	EO	P520	-	-	-	F-J, S-R	Category D. For packages carrying a subsidiary risk label of class 1, segregation as for class 1.3. "Separated from acids and alkalis. Protected from sources of heat."	May explode at elevated temperatures or in a fire. Burns vigorously. Immiscible in water. Contact with the eyes and skin should be avoided. Addition of water to disulcnic acid peroxide will decrease its thermal stability. May evolve irritant or toxic fumes.	3102
3103	ORGANIC PEROXIDE TYPE C, LIQUID	5.2	-	-	122 195 274	25 ml	EO	P520	-	-	-	F-J, S-R	Category D. "Separated from" acids and alkalis. Protected from sources of heat.	May decompose violently at elevated temperatures or in a fire. Burns vigorously. Immiscible with water except for tert-butyl hydroperoxide. Contact with the eyes and skin should be avoided. May evolve irritant or toxic fumes.	3103
3104	ORGANIC PEROXIDE TYPE C, SOLID	5.2	-	-	122 195 274	100 g	EO	P520	-	-	-	F-J, S-R	Category D. "Separated from" acids and alkalis. Protected from sources of heat.	May decompose violently at elevated temperatures or in a fire. Burns vigorously. Immiscible in water. Contact with the eyes and skin should be avoided. May evolve irritant or toxic fumes.	3104
3105	ORGANIC PEROXIDE TYPE D, LIQUID	5.2	-	-	122 274	125 ml	EO	P520	-	-	-	F-J, S-R	Category D. "Separated from" acids and alkalis. See 7.2.6.3.2. Protected from sources of heat.	Decomposes at elevated temperatures or in a fire. Burns vigorously. Immiscible with water except for acetyl acetone peroxide, tert-butylhydroperoxide and peroxyacetic acid, type D, stabilized. Contact with the eyes and skin should be avoided. May evolve irritant or toxic fumes.	3105
3106	ORGANIC PEROXIDE TYPE D, SOLID	5.2	-	-	122 274	500 g	EO	P520	-	-	-	F-J, S-R	Category D. "Separated from" acids and alkalis. Protected from sources of heat.	Decomposes at elevated temperatures or in a fire. Burns vigorously. Immiscible in water except for 3-chloroperoxybenzoic acid. Contact with the eyes and skin should be avoided. May evolve irritant or toxic fumes.	3106
3107	ORGANIC PEROXIDE TYPE E, LIQUID	5.2	-	-	122 274	125 ml	EO	P520	-	-	-	F-J, S-R	Category D. "Separated from" acids and alkalis. See 7.2.6.3.2. Protected from sources of heat.	Decomposes at elevated temperatures or in a fire. Burns vigorously. Immiscible with water except for tert-amy hydroperoxide, and tert-butyl hydroperoxide and peroxyacetic acid, type E, stabilized. Contact with the eyes and skin should be avoided. May evolve irritant or toxic fumes.	3107
3108	ORGANIC PEROXIDE TYPE E, SOLID	5.2	-	-	122 274	500 g	EO	P520	-	-	-	F-J, S-R	Category D. "Separated from" acids and alkalis. Protected from sources of heat.	Decomposes at elevated temperatures or in a fire. Burns vigorously. Immiscible in water. Contact with the eyes and skin should be avoided. May evolve irritant or toxic fumes.	3108
3109	ORGANIC PEROXIDE TYPE F, LIQUID	5.2	-	-	122 274	125 ml	EO	P520	-	IBC520	-	F-J, S-R	Category D. "Separated from" acids and alkalis. See 7.2.6.3.2. Protected from sources of heat.	Decomposes at elevated temperatures or in a fire. Burns vigorously. Immiscible with water except for tert-butylhydroperoxide, dibutyl peroxide, dilauroylperoxide and peroxyacetic acid, type F, stabilized. Contact with the eyes and skin should be avoided. May evolve irritant or toxic fumes.	3109
3110	ORGANIC PEROXIDE TYPE F, SOLID	5.2	-	-	122 274	500 g	EO	P520	-	IBC520	-	F-J, S-R	Category D. "Separated from" acids and alkalis. Protected from sources of heat.	Decomposes at elevated temperatures or in a fire. Burns vigorously. Immiscible in water. Contact with the eyes and skin should be avoided. May evolve irritant or toxic fumes.	3110

**TSFS 2015:66**  
**Bilaga 1**

UN No. (1)	PSN (2)	Class or Div (3)	Subsidiary Risk(s) (4)	Packing Group (5)	Special Provisions (6)	Limited quantities (7a)	Excepted quantities (7b)	Packing		IBC		EMs (15)	Stowage and Segregation (16)	Properties and Observations (17)	UN No. (18)	
								Instruc-tions (8)	Provisions (9)	Instruc-tions (10)	Provisions (11)					
3111	ORGANIC PEROXIDE TYPE B, LIQUID, TEMPERATURE CONTROLLED	5.2	See SP181	-	122 18 195 274 923	0	EO	P520	-	-	-	-	Category D. For packages carrying under temperature control, segregation as for class 1, division 1.3. Shall be transported under temperature control. Separated from acids and alkalis. Protected from sources of heat.	May explode at temperatures higher than the emergency temperature or in a fire. Burns vigorously, immiscible with water. Contact with the eyes and skin should be avoided. Control and emergency temperatures for each formulation are given in table 2.5.3.2.4. The temperature should be checked regularly. May evolve irritant or toxic fumes.	3111	
3112	ORGANIC PEROXIDE TYPE B, SOLID, TEMPERATURE CONTROLLED	5.2	See SP181	-	122 18 195 274 923	0	EO	P520	-	-	-	-	Category D. For packages carrying under temperature control, segregation as for class 1, division 1.3. Shall be transported under temperature control. Separated from acids and alkalis. Protected from sources of heat.	May explode at temperatures higher than the emergency temperature or in a fire. Burns vigorously, immiscible with water. Contact with the eyes and skin should be avoided. Control and emergency temperatures for each formulation are given in table 2.5.3.2.4. The temperature should be checked regularly. May evolve irritant or toxic fumes.	3112	
3113	ORGANIC PEROXIDE TYPE C, LIQUID, TEMPERATURE CONTROLLED	5.2	-	-	122 195 274 923	0	EO	P520	-	-	-	-	Category D. Shall be transported under temperature control. Separated from acids and alkalis. Protected from sources of heat.	May decompose violently at temperatures higher than the emergency temperature or in a fire. Burns vigorously, immiscible with water. Contact with the eyes and skin should be avoided. Control and emergency temperatures for each formulation are given in table 2.5.3.2.4. The temperature should be checked regularly. May evolve irritant or toxic fumes.	3113	
3114	ORGANIC PEROXIDE TYPE C, SOLID, TEMPERATURE CONTROLLED	5.2	-	-	122 274 923	0	EO	P520	-	-	-	-	Category D. Shall be transported under temperature control. Separated from acids and alkalis. Protected from sources of heat.	May decompose violently at temperatures higher than the emergency temperature or in a fire. Burns vigorously, immiscible with water. Contact with the eyes and skin should be avoided. Control and emergency temperatures for each formulation are given in table 2.5.3.2.4. The temperature should be checked regularly. May evolve irritant or toxic fumes.	3114	
3115	ORGANIC PEROXIDE TYPE D, LIQUID, TEMPERATURE CONTROLLED	5.2	-	-	122 274 923	0	EO	P520	-	-	-	-	Category D. Shall be transported under temperature control. Separated from acids and alkalis. Protected from sources of heat.	Decomposes at temperatures higher than the emergency temperature or in a fire. Burns vigorously, immiscible with water. Contact with the eyes and skin should be avoided. Control and emergency temperatures for each formulation are given in table 2.5.3.2.4. The temperature shall be checked regularly. May evolve irritant or toxic fumes.	3115	
3116	ORGANIC PEROXIDE TYPE D, SOLID, TEMPERATURE CONTROLLED	5.2	-	-	122 274 923	0	EO	P520	-	-	-	-	Category D. Shall be transported under temperature control. Separated from acids and alkalis. Protected from sources of heat.	Decomposes at temperatures higher than the emergency temperature or in a fire. Burns vigorously, immiscible with water except for diperoxy azelaic acid. Contact with the eyes and skin should be avoided. Control and emergency temperatures for each formulation are given in table 2.5.3.2.4. The temperature should be checked regularly. May evolve irritant or toxic fumes.	3116	
3117	ORGANIC PEROXIDE TYPE E, LIQUID, TEMPERATURE CONTROLLED	5.2	-	-	122 274	0	EO	P520	-	-	-	-	Category D. Shall be transported under temperature control. Separated from acids and alkalis. Protected from sources of heat.	Decomposes at temperatures higher than the emergency temperature or in a fire. Burns vigorously, immiscible with water. Contact with the eyes and skin should be avoided. Control and emergency temperatures for each formulation are given in table 2.5.3.2.4. The temperature should be checked regularly. May evolve irritant or toxic fumes.	3117	
3118	ORGANIC PEROXIDE TYPE E, SOLID, TEMPERATURE CONTROLLED	5.2	-	-	122 274 923	0	EO	P520	-	-	-	-	Category D. Shall be transported under temperature control. Separated from acids and alkalis. Protected from sources of heat.	Decomposes at temperatures higher than the emergency temperature or in a fire. Burns vigorously, immiscible with water except for di-(2-ethylhexyl) peroxycarbonate. Contact with the eyes and skin should be avoided. Control and emergency temperatures for each formulation are given in table 2.5.3.2.4. The temperature should be checked regularly. May evolve irritant or toxic fumes.	3118	
3119	ORGANIC PEROXIDE TYPE F, LIQUID, TEMPERATURE CONTROLLED	5.2	-	-	122 274 923	0	EO	P520	-	IBC520	-	T23	Category D. Shall be transported under temperature control. Separated from acids and alkalis. Protected from sources of heat.	Decomposes at temperatures higher than the emergency temperature or in a fire. Burns vigorously, immiscible with water except for di-(4-tert-butylcyclohexyl) peroxycarbonate, dicyclic peroxycarbonate and dicyclic peroxide. Contact with the eyes and skin should be avoided. Control and emergency temperatures for each formulation are given in table 2.5.3.2.4. The temperature should be checked regularly. May evolve irritant or toxic fumes.	3119	
3120	ORGANIC PEROXIDE TYPE F, SOLID, TEMPERATURE CONTROLLED	5.2	-	-	122 274 923	0	EO	P520	-	IBC520	-	TP23	Category D. Shall be transported under temperature control. Separated from acids and alkalis. Protected from sources of heat.	Decomposes at temperatures higher than the emergency temperature or in a fire. Burns vigorously, immiscible with water. Contact with the eyes and skin should be avoided. Control and emergency temperatures for each formulation are given in table 2.5.3.2.4. The temperature should be checked regularly. May evolve irritant or toxic fumes.	3120	
3121	OXIDIZING SOLID, WATER-REACTIVE, N.O.S.	5.1	4.3	I	76 274	0	EO	P099	-	-	-	-	-	-	-	3121
3121	OXIDIZING SOLID, WATER-REACTIVE, N.O.S.	5.1	4.3	II	76 274	0	E2	P099	-	-	-	-	-	-	-	3121

UN No. (1)	PSN (2)	Class (3)	Subsidiary Risk(s) (4)	Packing (5)	Special Provisions (6)	Limited quantities (7a)	Excepted quantities (7b)	Packing			IBC			UN No. (18)		
								Class (5)	Subsidiary Risk(s) (4)	Packing (5)	Special Provisions (6)	Limited quantities (7a)	Excepted quantities (7b)		Institutions (8)	Provisions (9)
	3.1.2	2.0	2.0	2.0.1.3	3.3	3.4	3.5	4.1.4	4.1.4	4.1.4	4.1.4	4.1.4				
3122	TOXIC LIQUID, OXIDIZING, N.O.S.	6.1	5.1	I	274 315	0	ES	P001	-	-	-	-	-	F-A, S-Q Category C.	Toxic if swallowed, by skin contact or by inhalation.	3122
3122	TOXIC LIQUID, OXIDIZING, N.O.S.	6.1	5.1	II	274	100 ml	E4	P001	-	IBC02	-	-	-	F-A, S-Q Category C.	See entry above.	3122
3123	TOXIC LIQUID, WATER-REACTIVE, N.O.S.	6.1	4.3	I	274 315	0	ES	P099	-	-	-	-	-	F-G, S-N Category D.	Clear of living quarters. Toxic if swallowed, by skin contact or by inhalation.	3123
3123	TOXIC LIQUID, WATER-REACTIVE, N.O.S.	6.1	4.3	II	274	100 ml	E4	P001	-	IBC02	-	-	-	F-G, S-N Category D.	Clear of living quarters. See entry above.	3123
3124	TOXIC SOLID, SELF-HEATING, N.O.S.	6.1	4.2	I	274	0	ES	P002	-	-	-	-	-	F-A, S-J Category D.	Clear of living quarters. Highly toxic if swallowed, by skin contact or by inhalation.	3124
3124	TOXIC SOLID, SELF-HEATING, N.O.S.	6.1	4.2	II	274	0	E4	P002	-	IBC06	B2	-	-	F-A, S-J Category D.	Clear of living quarters. See entry above.	3124
3125	TOXIC SOLID, WATER-REACTIVE, N.O.S.	6.1	4.3	I	274	0	ES	P099	-	-	-	-	-	F-G, S-N Category D.	Clear of living quarters. Toxic if swallowed, by skin contact or by inhalation.	3125
3125	TOXIC SOLID, WATER-REACTIVE, N.O.S.	6.1	4.3	II	274	500 g	E4	P002	-	IBC06	B2	-	-	F-G, S-N Category D.	Clear of living quarters. See entry above.	3125
3126	SELF-HEATING SOLID, CORROSIVE, ORGANIC, N.O.S.	4.2	8	II	76 223 274	0	E2	P410	-	IBC05	B2	-	-	F-A, S-J Category C.	-	3126
3126	SELF-HEATING SOLID, CORROSIVE, ORGANIC, N.O.S.	4.2	8	III	76 223 274	0	E1	P002	-	IBC08	B3	-	-	F-A, S-J Category C.	-	3126
3127	SELF-HEATING SOLID, OXIDIZING, N.O.S.	4.2	5.1	II	76 274	0	E2	P099	-	-	-	-	-	F-A, S-J Category C.	-	3127
3127	SELF-HEATING SOLID, OXIDIZING, N.O.S.	4.2	5.1	III	76 223 274	0	E1	P099	-	-	-	-	-	F-A, S-J Category C.	-	3127
3128	SELF-HEATING SOLID, TOXIC, ORGANIC, N.O.S.	4.2	6.1	II	76 274	0	E2	P410	-	IBC05	B2	-	-	F-A, S-J Category C.	-	3128
3128	SELF-HEATING SOLID, TOXIC, ORGANIC, N.O.S.	4.2	6.1	III	76 223 274	0	E1	P002	-	IBC08	B3	-	-	F-A, S-J Category C.	-	3128
3129	WATER-REACTIVE LIQUID, CORROSIVE, N.O.S.	4.3	8	I	76 274	0	ED	P402	-	-	-	-	-	F-G, S-N Category D.	-	3129
3129	WATER-REACTIVE LIQUID, CORROSIVE, N.O.S.	4.3	8	II	76 274	0	E2	P402	-	IBC01	-	-	-	F-G, S-N Category E. If under deck, in a mechanically ventilated space.	-	3129
3129	WATER-REACTIVE LIQUID, CORROSIVE, N.O.S.	4.3	8	III	76 223 274	0	E1	P001	-	IBC02	-	-	-	F-G, S-N Category E.	-	3129

**TSFS 2015:66  
Bilaga 1**

UN No. (1)	PSN (2)	Class No. (3)	Subsidiary Risk(s) (4)	Packing Group (5)	Special Provisions (6)	Limited quantities (7a)	Excepted quantities (7b)	Packing			Portable tanks and bulk containers			UN No. (18)			
								Gas or Div (8)	Class (9)	Institu-tions (10)	Institu-tions (11)	Provisions (12)	Provisions (13)		EMs (15)	Stowage and Segregation (16)	Properties and Observations (17)
	3.1.2	2.0	2.0	2.0	1.3	3.3	3.4	3.5	4.1, 4	4.1, 4	4.1, 4	4.1, 4	4.2, 5 4.3	5.4, 5.2 7.8	7.1 to 7.7		3130
3130 WATER-REACTIVE LIQUID, TOXIC, N.O.S.																	
3130		4.3	6.1	II	76 274	0	E2	P402	-	-	-	-	-	F-C, S-N	Category D.	-	3130
3130 WATER-REACTIVE LIQUID, TOXIC, N.O.S.																	
3130		4.3	6.1	III	76 223 274	0	E1	P001	-	IBC02	-	-	-	F-C, S-N	Category E. If under deck, in a mechanically ventilated space.	-	3130
3130 WATER-REACTIVE LIQUID, TOXIC, N.O.S.																	
3131		4.3	8	I	76 274	0	E0	P403	-	-	-	-	T9 TP33	F-G, S-L	Category D.	-	3131
3131 WATER-REACTIVE SOLID, CORROSIVE, N.O.S.																	
3131		4.3	8	II	76 274	0	E2	P410	PM40	IBC06	B2	-	T3	F-G, S-L	Category E. If under deck, in a mechanically ventilated space.	-	3131
3131 WATER-REACTIVE SOLID, CORROSIVE, N.O.S.																	
3131		4.3	8	III	76 223 274	0	E1	P410	-	IBC08	B4	-	T1	F-G, S-L	Category E. If under deck, in a mechanically ventilated space.	-	3131
3131 WATER-REACTIVE SOLID, CORROSIVE, N.O.S.																	
3132		4.3	4.1	I	76 274	0	E0	P403	-	IBC09	-	-	-	F-G, S-N	-	-	3132
3132 WATER-REACTIVE SOLID, FLAMMABLE, N.O.S.																	
3132		4.3	4.1	II	76 274	0	E2	P410	PM40	IBC04	-	-	T3	F-G, S-N	-	-	3132
3132 WATER-REACTIVE SOLID, FLAMMABLE, N.O.S.																	
3132		4.3	4.1	III	76 223 274	0	E1	P410	PM40	IBC06	-	-	T1	F-G, S-N	-	-	3132
3132 WATER-REACTIVE SOLID, FLAMMABLE, N.O.S.																	
3133		4.3	5.1	II	76 274	0	E2	P099	-	-	-	-	-	F-G, S-L	-	-	3133
3133 WATER-REACTIVE SOLID, OXIDIZING, N.O.S.																	
3133		4.3	5.1	III	76 223 274	0	E1	P099	-	-	-	-	-	F-G, S-L	-	-	3133
3133 WATER-REACTIVE SOLID, OXIDIZING, N.O.S.																	
3134		4.3	6.1	I	274	0	E0	P403	-	-	-	-	-	F-G, S-N	Category D.	-	3134
3134 WATER-REACTIVE SOLID, TOXIC, N.O.S.																	
3134		4.3	6.1	II	274	500 g	E2	P410	PM40	IBC05	B2	-	T3	F-G, S-N	Category E. If under deck, in a mechanically ventilated space.	-	3134
3134 WATER-REACTIVE SOLID, TOXIC, N.O.S.																	
3134		4.3	6.1	III	223 274	1 kg	E1	P410	-	IBC08	B4	-	T1	F-G, S-N	Category E. If under deck, in a mechanically ventilated space.	-	3134
3134 WATER-REACTIVE SOLID, TOXIC, N.O.S.																	
3135		4.3	4.2	I	76 274	0	E0	P403	-	-	-	-	-	F-C, S-N	-	-	3135
3135 WATER-REACTIVE SOLID, SELF-HEATING, N.O.S.																	
3135		4.3	4.2	II	76 274	0	E2	P410	-	IBC05	B2	-	T3	F-G, S-N	-	-	3135
3135 WATER-REACTIVE SOLID, SELF-HEATING, N.O.S.																	
3135		4.3	4.2	III	76 223 274	0	E1	P410	-	IBC08	B4	-	T1	F-G, S-N	-	-	3135
3135 WATER-REACTIVE SOLID, SELF-HEATING, N.O.S.																	

UN No. (1)	PSN (2)	Class (3)	Subsidiary Risk(s) (4)	Packing Group (5)	Special Provisions (6)	Limited quantities (7a)	Excepted quantities (7b)	Packing		IBC		ProPERTIES AND OBSERVATIONS (17)	UN No. (18)
								Institutions (8)	Provisions (9)	Institutions (10)	Provisions (11)		
3132		2.0	2.0	2.0	3.3	3.4	3.5	4.1, 4	4.1, 4	4.1, 4	4.1, 4		
3136 TRIFLUOROMETHANE, REFRIGERATED LIQUID													
2.2	-	-	-	-	-	120 mf	E1	P203	-	-	-	Liquefied, non-flammable gas. Much heavier than air (2.4).	3136
3137 OXIDIZING SOLID, FLAMMABLE, N.O.S.													
5.1	4.1	I	76	274	0	ED	P099	-	-	-	-	-	3137
3138 ETHYLENE ACETYLENE AND PROPYLENE MIXTURE, REFRIGERATED LIQUID, CONTAINING AT LEAST 71.5% ETHYLENE, WITH NOT MORE THAN 22.5% ACETYLENE AND NOT MORE THAN 6% PROPYLENE													
2.1	-	-	-	-	-	0	ED	P203	-	-	-	Liquefied, flammable, colourless mixture of gases, with a garlic odour. Explosive limits: 2.7% to 36%. Lighter than air (0.96).	3138
3139 OXIDIZING LIQUID, N.O.S.													
5.1	-	I	274	0	ED	P502	-	-	-	-	-	Category D. "Separated from" ammonium compounds, cyanides and peroxides.	3139
3139 OXIDIZING LIQUID, N.O.S.													
5.1	-	II	274	1 f	E2	P504	-	-	-	-	-	Category B. "Separated from" ammonium compounds, cyanides and peroxides.	3139
3139 OXIDIZING LIQUID, N.O.S.													
5.1	-	III	223	274	5 f	E1	P504	-	-	-	-	Category B. "Separated from" ammonium compounds, cyanides and peroxides.	3139
3140 ALKALOIDS, LIQUID, N.O.S. OF ALKALOIDS SALTS, LIQUID, N.O.S.													
6.1	-	I	43	274	0	ES	P001	-	-	-	-	A wide range of toxic liquids, generally of vegetable origin. Toxic if swallowed, by skin contact or by inhalation.	3140
3140 ALKALOIDS, LIQUID, N.O.S. OF ALKALOIDS SALTS, LIQUID, N.O.S.													
6.1	-	II	43	274	100 mf	E4	P001	-	-	-	-	See entry above.	3140
3140 ALKALOIDS, LIQUID, N.O.S. OF ALKALOIDS SALTS, LIQUID, N.O.S.													
6.1	-	III	43	223	5 f	E1	P001	-	-	-	-	See entry above.	3140
3141 ANTIMONY COMPOUND, INORGANIC, LIQUID, N.O.S.													
6.1	-	III	45	274	5 f	E1	P001	-	-	-	-	A wide range of toxic liquids. Toxic if swallowed, by skin contact or by inhalation.	3141
3142 DISINFECTANT, LIQUID, TOXIC, N.O.S.													
6.1	-	I	274	0	ES	P001	-	-	-	-	-	Category A. Clear of living quarters. A wide range of toxic liquids. Toxic if swallowed, by skin contact or by inhalation.	3142
3142 DISINFECTANT, LIQUID, TOXIC, N.O.S.													
6.1	-	II	274	100 mf	E4	P001	-	-	-	-	-	See entry above.	3142
3142 DISINFECTANT, LIQUID, TOXIC, N.O.S.													
6.1	-	III	223	274	5 f	E1	P001	-	-	-	-	See entry above.	3142
3143 DYE, SOLID, TOXIC, N.O.S. OF DYE INTERMEDIATE, SOLID, TOXIC, N.O.S.													
6.1	-	I	274	0	ES	P002	-	-	-	-	-	A wide range of toxic solids. Toxic if swallowed, by skin contact or by inhalation.	3143
3143 DYE, SOLID, TOXIC, N.O.S. OF DYE INTERMEDIATE, SOLID, TOXIC, N.O.S.													
6.1	-	II	274	500 g	E4	P002	-	-	-	-	-	See entry above.	3143
3143 DYE, SOLID, TOXIC, N.O.S. OF DYE INTERMEDIATE, SOLID, TOXIC, N.O.S.													
6.1	-	III	223	274	5 kg	E1	P002	-	-	-	-	See entry above.	3143
3144 NICOTINE COMPOUND, LIQUID, N.O.S. OF NICOTINE PREPARATION, LIQUID, N.O.S.													
6.1	-	I	43	0	ES	P001	-	-	-	-	-	A wide variety of toxic liquids. Toxic if swallowed, by skin contact or by inhalation.	3144

**TSFS 2015:66  
Bilaga 1**

UN No. (1)	PSN (2)	Class No. (3)	Subsidiary Risk(s) (4)	Packing Group (5)	Special Provisions (6)	Limited quantities (7a)	Excepted quantities (7b)	Packing		IBC	
								Instruc-tions (8)	Provisions (9)	Instruc-tions (10)	Provisions (11)
31.2		2.0	2.0	2.0, 1.3	3.3	3.4	3.5	4.1, 4	4.1, 4	4.1, 4	

3144 NICOTINE COMPOUND, LIQUID, N.O.S. or NICOTINE PREPARATION, LIQUID, N.O.S. 6.1 - II 43 100 ml E4 P001 - IBC02 - 3144

3144 NICOTINE COMPOUND, LIQUID, N.O.S. or NICOTINE PREPARATION, LIQUID, N.O.S. 6.1 - III 43 5 E1 P001 - IBC03 - 3144  
223  
274

3145 ALKYLPHENOLS, LIQUID, N.O.S. (including C2-C12 homologues) 8 - I - 0 E0 P001 - 3145

3145 ALKYLPHENOLS, LIQUID, N.O.S. (including C2-C12 homologues) 8 - II - 1 E2 P001 - IBC02 - 3145

3145 ALKYLPHENOLS, LIQUID, N.O.S. (including C2-C12 homologues) 8 - III 223 5 E1 P001 - IBC03 - 3145  
LPO1

3146 ORGANOTIN COMPOUND, SOLID, N.O.S. 6.1 - P 43 0 E5 P002 - IBC07 B1 274

3146 ORGANOTIN COMPOUND, SOLID, N.O.S. 6.1 - P 43 500 g E4 P002 - IBC08 B2 B4 274

3146 ORGANOTIN COMPOUND, SOLID, N.O.S. 6.1 - P 43 5 kg E1 P002 - IBC08 B3 274  
LPO2

3147 DYE, SOLID, CORROSIVE, N.O.S. or DYE INTERMEDIATE, SOLID, CORROSIVE, N.O.S. 8 - I 274 0 E0 P002 - IBC07 B1 274

3147 DYE, SOLID, CORROSIVE, N.O.S. or DYE INTERMEDIATE, SOLID, CORROSIVE, N.O.S. 8 - II 274 1 kg E2 P002 - IBC08 B2 B4 274

3147 DYE, SOLID, CORROSIVE, N.O.S. or DYE INTERMEDIATE, SOLID, CORROSIVE, N.O.S. 8 - III 223 5 kg E1 P002 - IBC08 B3 274  
LPO2

3148 WATER-REACTIVE LIQUID, N.O.S. 4.3 - I 274 0 E0 P402 PP31 - 3148

3148 WATER-REACTIVE LIQUID, N.O.S. 4.3 - II 274 500 ml E2 P402 PP31 IBC01 - 3148

3148 WATER-REACTIVE LIQUID, N.O.S. 4.3 - III 223 1 E1 P001 PP31 IBC02 - 3148  
274

3149 HYDROGEN PEROXIDE AND PEROXYACETIC ACID (containing not more than 3% peroxycetic acid, STABILIZED) 5.1 8 II 196 1 E2 P504 PP10 IBC02 B5 274

3150 DEVICES, SMALL, HYDROCARBON GAS POWERED, or HYDROCARBON GAS REFILLS FOR SMALL DEVICES with release device 2.1 - - - 0 E0 P003 - 3150

UN No. (1)	PSN (2)	Class No. (3)	Subsidiary Risk(s) (4)	Special Provisions (6)	Limited quantities (7a)	Excepted quantities (7b)	Packaging		Properties and Observations (17)
							Instruc-tions (8)	Provisions (9)	
4.2, 5, 4.3	4.2, 5, 4.3	4.2, 5, 4.3	4.2, 5, 4.3	4.2, 5, 4.3	4.2, 5, 4.3	4.2, 5, 4.3	4.2, 5, 4.3	4.2, 5, 4.3	

3144 F-A, S-A Category B. Clear of living quarters. See entry above. 3144

3144 F-A, S-A Category B. Clear of living quarters. See entry above. 3144

3145 F-A, S-B Category B. A wide range of colours to pale straw-coloured liquids with penetrating odours (sometimes campher-like). Liquids slightly miscible with water. Cause burns to skin, eyes and mucous membranes. See entry above. 3145

3145 F-A, S-B Category B. See entry above. 3145

3145 F-A, S-B Category A. See entry above. 3145

3146 F-A, S-A Category B. Clear of living quarters. A wide variety of toxic solids. Toxic if swallowed, by skin contact or by inhalation. 3146

3146 F-A, S-A Category A. Clear of living quarters. See entry above. 3146

3146 F-A, S-A Category A. Clear of living quarters. See entry above. 3146

3147 F-A, S-B Category A. A wide range of corrosive solids or pastes. Causes burns to skin, eyes and mucous membranes. 3147

3147 F-A, S-B Category A. See entry above. 3147

3147 F-A, S-B Category A. See entry above. 3147

3148 F-G, S-N Category E. Clear of living quarters. - 3148

3148 F-G, S-N Category E. Clear of living quarters. - 3148

3148 F-G, S-N Category E. Clear of living quarters. - 3148

3149 F-H, S-Q Category D. Protected from sources of ignition. Causes burns to skin, eyes and mucous membranes. Even though stabilized, these solutions may evolve oxygen. 3149

3150 F-D, S-U Category B. Clear of living quarters. Various small devices used for cosmetic and other purposes, and their refills. 3150

UN No. (1)	PSN (2)	Class or Div. (3)	Subsidiary Risk(s) (4)	Packing Group (5)	Special Provisions (6)	Limited quantities (7a)	Excepted quantities (7b)	Packing			IBC		ProPERTIES AND OBSERVATIONS (17)	UN No. (18)
								Class or Div. (3)	Subsidiary Risk(s) (4)	Packing Group (5)	Special Provisions (6)	Limited quantities (7a)		
3151	POLYHALOGENATED BIPHENYLS, LIQUID or POLYHALOGENATED TERPHENYLS, LIQUID	9	P	II	203 305	1 l	E2	P906	-	IBC02	-	Category A. Segregation from Class 3 in 7.3.4.2.1, 7.3.6.3.1.2 or 7.7.3.6.	Viscous liquids with a perceptible odour. Harmful by ingestion or by skin contact. May be fatal if swallowed. Contains flammable vapours and condensers, containing free liquid polyhalogenated biphenyls or polyhalogenated terphenyls.	3151
3152	POLYHALOGENATED BIPHENYLS, SOLID or POLYHALOGENATED TERPHENYLS, SOLID	9	P	II	203 305 958	1 kg	E2	P906	-	IBC08	B2 B4	Category A. Segregation from Class 3 in 7.3.4.2.1, 7.6.3.1.2 or 7.7.3.6.	Solid with a perceptible odour. Melting point of solids varies from 2°C to 164°C. Harmful by ingestion or by skin contact. This entry covers articles, such as rags, cotton waste, clothing, sawdust, containing polyhalogenated biphenyls or polyhalogenated terphenyls where no free visible liquid is present.	3152
3153	PERFLUORO (METHYL VINYL ETHER)	2.1	-	-	-	0	EO	P200	-	-	-	Category E. Clear of living quarters.	Explosive limits: 7% to 73%. Much heavier than air (6.4). Boiling point: -27°C.	3153
3154	PERFLUORO (ETHYL VINYL ETHER)	2.1	-	-	-	0	EO	P200	-	-	-	Category E. Clear of living quarters.	Explosive limits: 7% to 73%. Much heavier than air (6.4). Boiling point: 12°C.	3154
3155	PENTACHLOROPHENOL	6.1	P	II	43	500 g	E4	P002	-	IBC08	B2 B4	Category A.	Toxic if swallowed, by skin contact or by dust inhalation.	3155
3156	COMPRESSED GAS, OXIDIZING, N.O.S.	2.2	5.1	-	-	274	0	EO	P200	-	-	Category D.	-	3156
3157	LIQUEFIED GAS, OXIDIZING, N.O.S.	2.2	5.1	-	-	274	0	EO	P200	-	-	Category D.	-	3157
3158	GAS, REFRIGERATED LIQUID, N.O.S.	2.2	-	-	-	274	120 ml	E1	P203	-	-	Category D.	-	3158
3159	1,1,1,2-TETRAFLUOROETHANE (REFRIGERANT GAS R 134a)	2.2	-	-	-	-	120 ml	E1	P200	-	-	Category A.	Non-flammable gas with a mild ether-like odour. Much heavier than air (3.5).	3159
3160	LIQUEFIED GAS, TOXIC, FLAMMABLE, N.O.S.	2.3	2.1	-	-	274	0	EO	P200	-	-	Category D. Clear of living quarters.	-	3160
3161	LIQUEFIED GAS, FLAMMABLE, N.O.S.	2.1	-	-	-	274	0	EO	P200	-	-	Category D. Clear of living quarters.	-	3161
3162	LIQUEFIED GAS, TOXIC, N.O.S.	2.3	-	-	-	274	0	EO	P200	-	-	Category D. Clear of living quarters.	-	3162
3163	LIQUEFIED GAS, N.O.S.	2.2	-	-	-	274	120 ml	E1	P200	-	-	Category A.	-	3163
3164	ARTICLES, PRESSURIZED, PNEUMATIC or HYDRAULIC (containing non-flammable gas)	2.2	-	-	-	283	120 ml	EO	P003	-	-	Category A.	Articles containing non-flammable, non-toxic gas necessary for their operation.	3164
3165	AIRCRAFT HYDRAULIC POWER UNIT FUEL TANK (containing non-flammable, non-toxic gas)	3	6.1/8	I	-	0	EO	P301	-	-	-	Category D. Clear of living quarters. Segregation from Class 3 in 7.3.4.2.1, 7.3.6.3.1.2 and Class 8.	The mixture is miscible with water and may react dangerously with water. Harmful by ingestion or by skin contact or by inhalation. Causes burns to skin, eyes and mucous membranes.	3165
3166	ENGINE, INTERNAL COMBUSTION or VEHICLE, FLAMMABLE GAS POWERED or VEHICLE, FLAMMABLE LIQUID POWERED or ENGINE, FUEL CELL, FLAMMABLE LIQUID POWERED or ENGINE, FUEL CELL, FLAMMABLE GAS POWERED or VEHICLE, FUEL CELL, FLAMMABLE LIQUID POWERED	9	-	-	-	-	-	-	-	-	-	Category A.	Type of articles transported under this entry include internal combustion engines, compression-ignition engines, fuel cell powered engines, motor vehicles, hybrid vehicles, motorcycles and boats. *F-D, S-U for gases or F-E, S-E for liquids.	3166

**TSFS 2015:66**  
**Bilaga 1**

UN No. (1)	PSN (2)	Class No. (3)	Subsidiary Risk(s) (4)	Packing Group (5)	Special Provisions (6)	Limited quantities (7a)	Excepted quantities (7b)	Packing		IBC	
								Instruc-tions (8)	Provisions (9)	Instruc-tions (10)	Provisions (11)
3172		2.0	2.0	2.01.3	3.3	3.4	3.5	4.1.4	4.1.4	4.1.4	4.1.4

UN No. (16)	Properties and Observations (17)	Portable tanks and bulk containers		Stowage and Segregation (18)	Category D.
		Tank instructions (15)	Provisions (14)		
3167		4.2.5 4.3	4.2.5 7.8	54.5.2 7.8	7.1 to 7.7

3167	GAS SAMPLE, NON-PRESSURIZED, FLAMMABLE, N.O.S., not refrigerated liquid	2.1	-	-	209	0	ED	P201	-	-	-	-	F-D, S-U	Category D.	-	3167
3168	GAS SAMPLE, NON-PRESSURIZED, TOXIC, FLAMMABLE, N.O.S., not refrigerated liquid	2.3	2.1	-	209	0	ED	P201	-	-	-	-	F-D, S-U	Category D.	-	3168
3169	GAS SAMPLE, NON-PRESSURIZED, TOXIC, N.O.S., not refrigerated liquid	2.3	-	-	209	0	ED	P201	-	-	-	-	F-C, S-U	Category D.	-	3169
3170	ALUMINIUM SMELTING BY-PRODUCTS or ALUMINIUM REMELTING BY-PRODUCTS	4.3	-	II	244	500 g	E2	P410	PP31 PM40	IBC07	B2	T3 BK2	F-G, S-P	Category B.	Under deck, in a mechanically ventilated space. Only to be loaded under dry weather conditions.	3170
3170	ALUMINIUM SMELTING BY-PRODUCTS or ALUMINIUM REMELTING BY-PRODUCTS	4.3	-	III	223 244	1 kg	E1	P002	PP31	IBC08	B4	T1 BK2	F-G, S-P	Category B.	Under deck, in a mechanically ventilated space. Only to be loaded under dry weather conditions.	3170
3171	BATTERY-POWERED VEHICLE or BATTERY-POWERED EQUIPMENT	9	-	-	240 961 962	-	-	-	-	-	-	-	F-A, S-I	Category A.	Types of articles transported under this entry include vehicles or equipment powered by wet batteries, sodium batteries or lithium batteries with the batteries installed, such as electrically-powered cars, lawnmowers, wheelchairs and other mobility aids.	3171
3172	TOXINS, EXTRACTED FROM LIVING SOURCES, LIQUID, N.O.S.	6.1	-	I	210 274	0	E5	P001	-	IBC03	-	-	F-A, S-A	Category B.	Toxins from plant, animal or bacterial sources which contain infectious substances or toxins that are contained in infectious substances should be classified in class 6.2, toxic if swallowed, by skin contact or by inhalation.	3172
3172	TOXINS, EXTRACTED FROM LIVING SOURCES, LIQUID, N.O.S.	6.1	-	II	210 274	100 ml	E4	P001	-	IBC02	-	-	F-A, S-A	Category B.	See entry above.	3172
3172	TOXINS, EXTRACTED FROM LIVING SOURCES, LIQUID, N.O.S.	6.1	-	III	210 223 274	5 l	E1	P001 LP01	-	IBC03	-	-	F-A, S-A	Category A.	See entry above.	3172
3174	TITANIUM DISULPHIDE	4.2	-	III	-	0	E1	P002 LP02	PP31	IBC08	B3	T1	F-A, S-F	Category A.	Yellow or grey powder with an unpleasant odour. In contact with water slowly evolves hydrogen sulphide gas.	3174
3175	SOLIDS CONTAINING FLAMMABLE LIQUID, N.O.S.	4.1	-	II	216 274	1 kg	E2	P002	PP9	IBC06	B2	T3 BK2	F-A, S-I	Category B.	Mixtures of non-dangerous solids (such as soil, sand, production materials etc.) and flammable liquids.	3175
3176	FLAMMABLE SOLID, ORGANIC, MOLTEN, N.O.S.	4.1	-	II	274	0	ED	-	-	-	-	T3	F-A, S-H	Category C.	Shipped molten above its melting point.	3176
3176	FLAMMABLE SOLID, ORGANIC, MOLTEN, N.O.S.	4.1	-	III	223 274	0	ED	-	-	-	-	T1	F-A, S-H	Category C.	See entry above.	3176
3178	FLAMMABLE SOLID, INORGANIC, N.O.S.	4.1	-	II	274 915	1 kg	E2	P002	-	IBC08	B2 B4	T3	F-A, S-G	Category B.	-	3178
3178	FLAMMABLE SOLID, INORGANIC, N.O.S.	4.1	-	III	223 274 915	5 kg	E1	P002 LP02	-	IBC08	B3	T1	F-A, S-G	Category B.	-	3178
3179	FLAMMABLE SOLID, TOXIC, INORGANIC, N.O.S.	4.1	6.1	II	224 915	1 kg	E2	P002	-	IBC06	B2	T3	F-A, S-G	Category B.	Clear of living quarters. Toxic if swallowed, by skin contact or by dust inhalation. Should be handled with care to minimize exposure, particularly to dust.	3179



UN No. (1)	PSN (2)	Class No. (3)	Subsidiary Risk(s) (4)	Packing Group (5)	Special Provisions (6)	Limited quantities (7a)	Excepted quantities (7b)	Packing		IBC		Properties and Observations (17)	UN No. (18)
								Instruc-tions (8)	Provisions (9)	Instruc-tions (10)	Provisions (11)		
3179	FLAMMABLE SOLID, TOXIC, INORGANIC, N.O.S.	4.1	6.1	III	223 224 274 915	5 kg	E1	P002	-	IBC06	-	Category B. Clear of living quarters. See entry above.	3179
3180	FLAMMABLE SOLID, CORROSIVE, INORGANIC, N.O.S.	4.1	8	II	274 915	1 kg	E2	P002	-	IBC06	B2	Category D. Clear of living quarters. Causes burns to skin, eyes and mucous membranes.	3180
3180	FLAMMABLE SOLID, CORROSIVE, INORGANIC, N.O.S.	4.1	8	III	223 224 274 915	5 kg	E1	P002	-	IBC06	-	Category D. Clear of living quarters. See entry above.	3180
3181	METAL SALTS OF ORGANIC COMPOUNDS; FLAMMABLE, N.O.S.	4.1	-	II	274	1 kg	E2	P002	PP3	IBC08	B2 B4	Category B. Clear of living quarters. Decomposes in water. Liable to spontaneous heating. Irritating to skin and mucous membranes.	3181
3181	METAL SALTS OF ORGANIC COMPOUNDS; FLAMMABLE, N.O.S.	4.1	-	III	223 274	5 kg	E1	P002 LPO2	PP3	IBC08	B3	Category B. Clear of living quarters. See entry above.	3181
3182	METAL HYDRIDES; FLAMMABLE, N.O.S.	4.1	-	II	274	1 kg	E2	P410	PP3 PH40	IBC04	-	Category E.	3182
3182	METAL HYDRIDES; FLAMMABLE, N.O.S.	4.1	-	III	223 274	5 kg	E1	P002	PP3	IBC04	-	Category E.	3182
3183	SELF-HEATING LIQUID, ORGANIC, N.O.S.	4.2	-	II	274	0	E2	P001	PP3	IBC02	-	Category C.	3183
3183	SELF-HEATING LIQUID, ORGANIC, N.O.S.	4.2	-	III	223 274	0	E1	P001	PP3	IBC02	-	Category C.	3183
3184	SELF-HEATING LIQUID, TOXIC, ORGANIC, N.O.S.	4.2	6.1	II	274	0	E2	P402	PP3	IBC02	-	Category C.	3184
3184	SELF-HEATING LIQUID, TOXIC, ORGANIC, N.O.S.	4.2	6.1	III	223 274	0	E1	P001	PP3	IBC02	-	Category C.	3184
3185	SELF-HEATING LIQUID, CORROSIVE, ORGANIC, N.O.S.	4.2	8	II	274	0	E2	P402	PP3	IBC02	-	Category C.	3185
3185	SELF-HEATING LIQUID, CORROSIVE, ORGANIC, N.O.S.	4.2	8	III	223 274	0	E1	P001	PP3	IBC02	-	Category C.	3185
3186	SELF-HEATING LIQUID, INORGANIC, N.O.S.	4.2	-	II	274	0	E2	P001	PP3	IBC02	-	Category C.	3186
3186	SELF-HEATING LIQUID, INORGANIC, N.O.S.	4.2	-	III	223 274	0	E1	P001	PP3	IBC02	-	Category C.	3186
3187	SELF-HEATING LIQUID, TOXIC, INORGANIC, N.O.S.	4.2	6.1	II	274	0	E2	P402	PP3	IBC02	-	Category C.	3187
3187	SELF-HEATING LIQUID, TOXIC, INORGANIC, N.O.S.	4.2	6.1	III	223 274	0	E1	P001	PP3	IBC02	-	Category C.	3187

TSFS 2015:66  
Bilaga 1

UN No. (1)	PSN (2)	Class or Div (5)	Subsidiary Risk(s) (4)	Packing Group (3)	Special Provisions (6)	Limited quantities (7a)	Excepted quantities (7b)	Packing			IBC			Tank instructions (15)	Provisions (14)	EHS (15)	Stowage and Segregation (16)	Properties and Observations (17)	UN No. (18)
								Class (5)	Subsidiary Risk(s) (4)	Packing Group (3)	Instruct-ions (8)	Provisions (9)	Instruc-tions (10)						
3188	SELF-HEATING LIQUID, CORROSIVE, INORGANIC, N.O.S.	4.2	8	II	274	0	E2	P402	PP31	IBC02	-	-	-	-	-	F-A, S-J	Category C.	-	3188
3188	SELF-HEATING LIQUID, CORROSIVE, INORGANIC, N.O.S.	4.2	8	III	223 274	0	E1	P001	PP31	IBC02	-	-	-	-	-	F-A, S-J	Category C.	-	3188
3189	METAL POWDER, SELF-HEATING, N.O.S.	4.2	-	II	274	0	E2	P410	PP31	IBC06	B2	T3	TP33	F-G, S-J	Category C.	-	Forms explosive mixtures with oxidizing substances.	3189	
3189	METAL POWDER, SELF-HEATING, N.O.S.	4.2	-	III	223 274	0	E1	P002 LP02	PP31	IBC08	B3	T1	TP33	F-G, S-J	Category C.	-	See entry above.	3189	
3190	SELF-HEATING SOLID, INORGANIC, N.O.S.	4.2	-	II	274	0	E2	P410	PP31	IBC06	B2	T3	TP33	F-A, S-J	Category C.	-	Liabile to self-heating or spontaneous combustion.	3190	
3190	SELF-HEATING SOLID, INORGANIC, N.O.S.	4.2	-	III	223 274	0	E1	P002 LP02	PP31	IBC08	B3	T1	TP33	F-A, S-J	Category C.	-	See entry above.	3190	
3191	SELF-HEATING SOLID, TOXIC, INORGANIC, N.O.S.	4.2	6.1	II	274	0	E2	P410	-	IBC05	B2	T3	TP33	F-A, S-J	Category C.	-	-	3191	
3191	SELF-HEATING SOLID, TOXIC, INORGANIC, N.O.S.	4.2	6.1	III	223 274	0	E1	P002	-	IBC08	B3	T1	TP33	F-A, S-J	Category C.	-	-	3191	
3192	SELF-HEATING SOLID, CORROSIVE, INORGANIC, N.O.S.	4.2	8	II	274	0	E2	P410	-	IBC05	B2	T3	TP33	F-A, S-J	Category C.	-	-	3192	
3192	SELF-HEATING SOLID, CORROSIVE, INORGANIC, N.O.S.	4.2	8	III	274	0	E1	P002	-	IBC08	B3	T1	TP33	F-A, S-J	Category C.	-	-	3192	
3194	PYROPHORIC LIQUID, INORGANIC, N.O.S.	4.2	-	I	274	0	E0	P400	-	-	-	-	-	-	F-G, S-M	Category D. Separated longitudinally by an intervening complete compartment or hold from Class 1.	Highly flammable liquids, may ignite spontaneously in moist air, in contact with air, evolve irritating and slightly toxic fumes.	3194	
3200	PYROPHORIC SOLID, INORGANIC, N.O.S.	4.2	-	I	274	0	E0	P404	PP31	-	-	T21	TP7 TP33	F-G, S-M	Category D.	-	Liabile to ignite spontaneously in air. If shaken, may produce sparks. In contact with water, evolve hydrogen, a flammable gas.	3200	
3205	ALKALINE EARTH METAL ALCOHOLATES, N.O.S.	4.2	-	II	183 274	0	E2	P410	PP31	IBC06	B2	T3	TP33	F-A, S-J	Category B.	-	Free-flowing hygroscopic powder. Irritating to skin, eyes and mucous membranes.	3205	
3205	ALKALINE EARTH METAL ALCOHOLATES, N.O.S.	4.2	-	III	183 223 274	0	E1	P002 LP02	PP31	IBC08	B3	T1	TP33	F-A, S-J	Category B.	-	See entry above.	3205	
3206	ALKALI METAL ALCOHOLATES, SELF-HEATING, CORROSIVE, N.O.S.	4.2	8	II	182 274	0	E2	P410	PP31	IBC05	B2	T3	TP33	F-A, S-J	Category B.	-	Free-flowing hygroscopic powder. Cause burns to skin, eyes and mucous membranes.	3206	
3206	ALKALI METAL ALCOHOLATES, SELF-HEATING, CORROSIVE, N.O.S.	4.2	8	III	182 223 274	0	E1	P002	PP31	IBC08	B3	T1	TP33	F-A, S-J	Category B.	-	See entry above.	3206	
3208	METALLIC SUBSTANCE, WATER-REACTIVE, N.O.S.	4.3	-	I	274	0	E0	P403	PP31	IBC09	-	-	-	-	F-G, S-N	Category E. Clear of living quarters.	-	3208	

UN No. (1)	PSN (2)	Class or Div (5)	Subsidiary Risk(s) (4)	Packing Group (3)	Special Provisions (6)	Limited quantities (7a)	Exempted quantities (7b)	Packing		IBC		Tank instructions (15)	Provisions (14)	EMs (15)	Stowage and Segregation (16)	Properties and Observations (17)	UN No. (18)
								Class or Div (5)	Subsidiary Risk(s) (4)	Packing Group (3)	Special Provisions (6)						
3208	METALLIC SUBSTANCE, WATER-REACTIVE, N.O.S.	4.3	-	II	274	500 g	E2	P410	PP31	IBC07	B2	T3	TP33	F-C, S-N	Category E. Clear of living quarters.	-	3208
3208	METALLIC SUBSTANCE, WATER-REACTIVE, N.O.S.	4.3	-	III	223 274	1 kg	E1	P410	PP31 PM40	IBC08	B4	T1	TP33	F-C, S-N	Category E. Clear of living quarters.	-	3208
3209	METALLIC SUBSTANCE, WATER-REACTIVE, SELF-HEATING, N.O.S.	4.3	4.2	I	274	0	E0	P403	PP31	-	-	-	-	F-C, S-N	Category E. Clear of living quarters.	-	3209
3209	METALLIC SUBSTANCE, WATER-REACTIVE, SELF-HEATING, N.O.S.	4.3	4.2	II	274	0	E2	P410	PP31 PM40	IBC05	B2	T3	TP33	F-C, S-N	Category E. Clear of living quarters.	-	3209
3209	METALLIC SUBSTANCE, WATER-REACTIVE, SELF-HEATING, N.O.S.	4.3	4.2	III	223 274	0	E1	P410	PP31	IBC08	B4	T1	TP33	F-C, S-N	Category E. Clear of living quarters.	-	3209
3210	CHLORATES, INORGANIC, AQUEOUS SOLUTION, N.O.S.	5.1	-	II	274 351	1 ℓ	E2	P504	-	IBC02	-	T4	TP1	F-H, S-Q	Category B. "Separated from" ammonium compounds, cyanides and sulphur.	When involved in a fire, may cause an explosion. Leakage and subsequent evaporation of the water of the solutions may present increased dangers 1. in contact with combustible material (particularly with fibrous material such as jute, cotton or sisal) or sulphur, danger of spontaneous combustion; 2. in contact with ammonium compounds, powdered metals or oils, danger of explosion.	3210
3210	CHLORATES, INORGANIC, AQUEOUS SOLUTION, N.O.S.	5.1	-	III	223 274 351	5 ℓ	E1	P504	-	IBC02	-	T4	TP1	F-H, S-Q	Category B. "Separated from" ammonium compounds, cyanides and sulphur.	Transport of ammonium chlorate, aqueous solution is prohibited. See entry above.	3210
3211	PERCHLORATES, INORGANIC, AQUEOUS SOLUTION, N.O.S.	5.1	-	II	-	1 ℓ	E2	P504	-	IBC02	-	T4	TP1	F-H, S-Q	Category B. "Separated from" ammonium compounds, cyanides and sulphur.	When involved in a fire, may cause an explosion. Leakage and subsequent evaporation of the water of the solutions may present increased dangers as follows: 1. in contact with combustible material (particularly with fibrous material such as jute, cotton or sisal) or sulphur, danger of spontaneous combustion; 2. in contact with ammonium compounds, powdered metals or oils, danger of explosion.	3211
3211	PERCHLORATES, INORGANIC, AQUEOUS SOLUTION, N.O.S.	5.1	-	III	223 900 903	5 ℓ	E1	P504	-	IBC02	-	T4	TP1	F-H, S-Q	Category B. "Separated from" ammonium compounds, cyanides and sulphur.	See entry above.	3211
3212	HYPOCHLORITES, INORGANIC, N.O.S.	5.1	-	II	274 900 903	1 kg	E2	P002	-	IBC08	B2 B4	T3	TP33	F-H, S-Q	Category D. Category E. Closed Cargo Transport Unit and pallet are not permitted. The possible need to open hatches in case of fire to provide maximum ventilation and to apply water in an emergency, shall be considered before loading. The stability of the ship through flooding of the cargo space, shall be considered before loading. Hydrogen peroxide and liquid organic substances. Protected from sources of heat.	Solids. Critical ambient temperature of decomposition may be as low as 60°C. May cause fire in contact with organic material or ammonium compounds. May cause fire and toxic gas in the presence of moisture, corrosive to most metals. Dust irritates mucous membranes. Transport of ammonium hypochlorite and mixtures of a hypochlorite with an ammonium salt is prohibited.	3212

UN No. (1)	PSN (2)	Class No. (3)	Subsidiary Risk(s) (4)	Packing Group (5)	Special Provisions (6)	Limited quantities (7a)	Excepted quantities (7b)	Instructi- ons (8)	Provisions (9)	Instructi- ons (10)	Provisions (11)
	3.1.2	2.0	2.0	2.0, 1.3	3.3	3.4	3.5	4.1, 4	4.1, 4	4.1, 4	4.1, 4

3213 BROMATES, INORGANIC, AQUEOUS SOLUTION, N.O.S.

T4	TP1	F-H, S-Q	Category B. "Separated from" ammonium compounds, cyanides and sulphur.	When involved in a fire, may cause an explosion. Leakage and subsequent evaporation of the water of the solutions may present increased dangers as follows: 1. in contact with combustible material (particularly with fibrous material such as jute, cotton or sisal) or sulphur, danger of spontaneous combustion; 2. in contact with ammonium compounds, powdered metals or oils, danger of explosion.	UN No. (16) (17)	UN No. (18)
----	-----	----------	--	---	---------------------	-------------

3213 BROMATES, INORGANIC, AQUEOUS SOLUTION, N.O.S.	5.1	-	III	223 274 350		1 ℓ	E2	P504	-	IBC02	-	3213
3214 PERMANGANATES, INORGANIC, AQUEOUS SOLUTION, N.O.S.	5.1	-	II	224 353		1 ℓ	E2	P504	-	IBC02	-	3214

When involved in a fire, may cause an explosion. Leakage and subsequent evaporation of the water of the solutions may present increased dangers as follows:  
1. in contact with combustible material (particularly with fibrous material such as jute, cotton or sisal) or sulphur, danger of spontaneous combustion;  
2. in contact with ammonium compounds, powdered metals or oils, danger of explosion.

Transport of ammonium bromate, aqueous solution is prohibited.

See entry above.

When involved in a fire, may cause an explosion. Leakage and subsequent evaporation of the water of the solutions may present increased dangers as follows:  
1. in contact with combustible material (particularly with fibrous material such as jute, cotton or sisal) or sulphur, danger of spontaneous combustion;  
2. in contact with ammonium compounds, powdered metals or oils, danger of explosion.

Transport of ammonium permanganate, aqueous solution is prohibited.

3215 PERSULPHATES, INORGANIC, N.O.S.	5.1	-	III	-	5 kg	E1	P002 L002	-	IBC08	B3	-	3215
3216 PERSULPHATES, INORGANIC, AQUEOUS SOLUTION, N.O.S.	5.1	-	III	-	5 ℓ	E1	P504	-	IBC02	-	-	3216

Solids. Solid mixtures with combustible material are sensitive to friction and liable to ignite, especially when mixed with cyanides heated or by friction. May form explosive mixture with powdered metals or ammonium compounds.

Category A. "Separated from" ammonium compounds, cyanides and sulphur. However the segregation provisions concerning ammonium mixtures of ammonium persulphates and/or sodium persulphates.

Category B. "Separated from" ammonium compounds, cyanides and sulphur.

When involved in a fire, may cause an explosion. Leakage and subsequent evaporation of the water of the solutions may present increased dangers as follows:  
1. in contact with combustible material (particularly with fibrous material such as jute, cotton or sisal) or sulphur, danger of spontaneous combustion;  
2. in contact with ammonium compounds, powdered metals or oils, danger of explosion.

3218 NITRATES, INORGANIC, AQUEOUS SOLUTION, N.O.S.	5.1	-	II	270	1 ℓ	E2	P504	-	IBC02	-	-	3218
3219 NITRITES, INORGANIC, AQUEOUS SOLUTION, N.O.S.	5.1	-	III	223 270		5 ℓ	E1	P504	-	IBC02	-	3218

Category B. "Separated from" ammonium compounds, cyanides and sulphur.

When involved in a fire, may cause an explosion. Leakage and subsequent evaporation of the water of the solutions may present increased dangers as follows:  
1. in contact with combustible material (particularly with fibrous material such as jute, cotton or sisal) or sulphur, danger of spontaneous combustion;  
2. in contact with ammonium compounds, powdered metals or oils, danger of explosion.

See entry above.

3219 NITRITES, INORGANIC, AQUEOUS SOLUTION, N.O.S.	5.1	-	III	223 274 350		5 ℓ	E1	P504	-	IBC02	-	3219
3220 PENTAFLUOROETHANE (REFRIGERANT GAS R 125)	2.2	-	-	-	120 mℓ	E1	P200	-	-	-	-	3220

Category B. "Separated from" ammonium compounds, cyanides and sulphur.

When involved in a fire, may cause an explosion. Leakage and subsequent evaporation of the water of the solutions may present increased dangers as follows:  
1. in contact with combustible material (particularly with fibrous material such as jute, cotton or sisal) or sulphur, danger of spontaneous combustion;  
2. in contact with ammonium compounds, powdered metals or oils, danger of explosion.

Transport of ammonium nitrites, aqueous solution is prohibited.

See entry above.

Category A.

Liquefied, non-flammable gas with a mild ether-like odour. Much heavier than air (d=2).



**TSFS 2015:66**  
**Bilaga 1**

UN No. (1)	PSN (2)	Class No. (3)	Subsidiary Risk(s) (4)	Packing Group (5)	Special Provisions (6)	Limited quantities (7a)	Excepted quantities (7b)	Packing			IBC			
								Instruc-tions (8)	Provisions (9)	Instruc-tions (10)	Provisions (11)			
3.1.2		2.0	2.0	2.0, 1.3	3.3	3.4	3.5	4.1, 4	4.1, 4	4.1, 4				

UN No. (16)	Properties and Observations (17)	Stowage and Segregation (16)	EHS (15)	Portable tanks and bulk containers		F-, S-K	3233
				Tank instructions (15)	Provisions (14)		
		7.1 to 7.7	54, 5.2 7.8	4.2, 5 4.3	4.2, 5		

3233	SELF-REACTIVE LIQUID TYPE C, TEMPERATURE CONTROLLED	4.1	-	-	194 274 523	0	EO	P520	PP21	-	-	-	-	-	Category D. "Separated from" acids and alkalis. Shall be transported under temperature control. Protected from sources of heat.	F-, F-, S-K	May explode at temperatures higher than the emergency temperature or in a fire. Burns vigorously. Insoluble in water except:	UN No. (16)	
3234	SELF-REACTIVE SOLID TYPE C, TEMPERATURE CONTROLLED	4.1	-	-	194 274 523	0	EO	P520	PP21	-	-	-	-	-	Category D. "Separated from" acids and alkalis. Shall be transported under temperature control. Protected from sources of heat.	F-, F-, S-K	May explode at temperatures higher than the emergency temperature or in a fire. Burns vigorously. Insoluble in water except:		
3235	SELF-REACTIVE LIQUID TYPE D, TEMPERATURE CONTROLLED	4.1	-	-	194 274 523	0	EO	P520	-	-	-	-	-	-	Category D. "Separated from" acids and alkalis. Shall be transported under temperature control. Protected from sources of heat.	F-, F-, S-K	Decomposes at temperatures higher than the emergency temperature or in a fire. Burns vigorously. Immiscible with water. Contact with alkalis or self-accelerating decomposition may be toxic by inhalation.		
3236	SELF-REACTIVE SOLID TYPE D, TEMPERATURE CONTROLLED	4.1	-	-	194 274 523	0	EO	P520	-	-	-	-	-	-	Category D. "Separated from" acids and alkalis. Shall be transported under temperature control. Protected from sources of heat.	F-, F-, S-K	Decomposes at temperatures higher than the emergency temperature or in a fire. Burns vigorously. Soluble in water except:		
3237	SELF-REACTIVE LIQUID TYPE E, TEMPERATURE CONTROLLED	4.1	-	-	194 274 523	0	EO	P520	-	-	-	-	-	-	Category D. "Separated from" acids and alkalis. Shall be transported under temperature control. Protected from sources of heat.	F-, F-, S-K	Decomposes at temperatures higher than the emergency temperature or in a fire. Burns vigorously. Immiscible with water. Contact with alkalis or acids may cause dangerous decomposition. The products of combustion or self-accelerating decomposition may be toxic by inhalation. Control and emergency temperatures for each formulation can be found in 2.4.2.3.3. The temperature should be checked regularly.		
3238	SELF-REACTIVE SOLID TYPE E, TEMPERATURE CONTROLLED	4.1	-	-	194 274 523	0	EO	P520	-	-	-	-	-	-	Category D. "Separated from" acids and alkalis. Shall be transported under temperature control. Protected from sources of heat.	F-, F-, S-K	Decomposes at temperatures higher than the emergency temperature or in a fire. Burns vigorously. Insoluble in water. Contact with alkalis or acids may cause dangerous decomposition. The products of combustion or self-accelerating decomposition may be toxic by inhalation. Control and emergency temperatures for each formulation can be found in 2.4.2.3.3. The temperature should be checked regularly.		
3239	SELF-REACTIVE LIQUID TYPE F, TEMPERATURE CONTROLLED	4.1	-	-	194 274 523	0	EO	P520	-	-	-	-	-	-	Category D. "Separated from" acids and alkalis. Shall be transported under temperature control. Protected from sources of heat.	F-, F-, S-K	Decomposes at temperatures higher than the emergency temperature or in a fire. Burns vigorously. Immiscible with water. Contact with alkalis or acids may cause dangerous decomposition. The products of combustion or self-accelerating decomposition may be toxic by inhalation. Control and emergency temperatures for each formulation can be found in 2.4.2.3.3. The temperature must be checked regularly.		
3240	SELF-REACTIVE SOLID TYPE F, TEMPERATURE CONTROLLED	4.1	-	-	194 274 523	0	EO	P520	-	-	-	-	-	-	Category D. "Separated from" acids and alkalis. Shall be transported under temperature control. Protected from sources of heat.	F-, F-, S-K	Decomposes at temperatures higher than the emergency temperature or in a fire. Burns vigorously. Insoluble in water. Contact with alkalis or acids may cause dangerous decomposition. The products of combustion or self-accelerating decomposition may be toxic by inhalation. Control and emergency temperatures for each formulation can be found in 2.4.2.3.3. The temperature must be checked regularly.		
3241	2-BROMO-2-NITROPROPANE-1,3-DIOL	4.1	-	III	-	5 kg	E1	P520	PP22	IBC08	B3	-	-	Category C. Protected from sources of heat. Clear of living quarters. Keep as far away from heat as possible. During transport, it shall be stored (or kept) in a cool ventilated place.	F-, J-, S-C	White crystals. Soluble in water. Decomposes when heated, evolving toxic gas. Sensitive to strong detonation shock. This substance shall be packed in accordance with packing method OPG (see applicable packing instructions).			
3242	AZODICARBONAMIDE	4.1	-	II	215	500 g	E2	P409	-	-	-	-	-	Category D. "Separated from" class 5.1, acids and alkalis.	F-, J-, S-C	Yellow or orange powder. Insoluble in water. Heat may cause exothermic decomposition, producing carbon monoxide (toxic and flammable gas) and nitrogen. May explode if involved in a fire under confined conditions. May decompose in a fire, producing toxic gas. May cause a decrease of thermal stability and/or a change in explosive properties.			

UN No. (1)	PSN (2)	Class No. (3)	Subsidiary Risk(s) (4)	Packing Group (5)	Special Provisions (6)	Limited quantities (7a)	Excepted quantities (7b)	Packing		IBC		Tank instructions (15)	Provisions (14)	EMs (15)	Stowage and Segregation (16)	Properties and Observations (17)	UN No. (18)
								Institutions (8)	Provisions (9)	Institutions (10)	Provisions (11)						
3243	SOLIDS CONTAINING TOXIC LIQUID, N.O.S.	6.1	-	II	217 274	500 g	E4	P002	P99	IBC02	-	T3 B62	TP33	F-A, S-A	Category B. Clear of living quarters. Mixtures of non-dangerous solids (such as soil, sand, production aids) and toxic liquids. Toxic if swallowed, by skin contact or by inhalation.	3243	
3244	SOLIDS CONTAINING CORROSIVE LIQUID, N.O.S.	8	-	II	218 274	1 kg	E2	P002	P99	IBC05	-	T3 B62	TP33	F-A, S-B	Category B. Clear of living quarters. Mixtures of non-dangerous solids (such as soil, sand, production materials, etc.) and corrosive liquids. Causes burns to skin, eyes and mucous membranes.	3244	
3245	GENETICALLY MODIFIED MICROORGANISMS or GENETICALLY MODIFIED ORGANISMS	9	-	-	219	0	E0	P904	-	IBC99	-	-	-	F-A, S-T	As approved by the competent authorities of the countries involved in the transport. Segregation from foodstuffs as in 7.3.4.2.1, 7.6.3.1.2 or 7.7.3.6.	3245	
3246	METHANESULPHONYL CHLORIDE	6.1	8	I	354	0	E0	P602	-	-	-	T20 TP13 TP37	F-A, S-B	Category D. Clear of living quarters. Pale yellow liquid. Highly toxic if swallowed, by skin contact or by inhalation. Causes burns to skin, eyes and mucous membranes.	3246		
3247	SODIUM PERBORATE, ANHYDROUS	5.1	-	II	-	1 kg	E2	P002	-	IBC08	B2 B4	T3	TP33	F-A, S-Q	Category A. Keep as dry as possible. Highly combustible material, readily ignited and may burn fiercely. Harmful if swallowed.	3247	
3248	MEDICINE, LIQUID, FLAMMABLE, TOXIC, N.O.S.	3	6.1	II	220 221	1 l	E2	P001	-	-	-	-	-	F-E, S-D	Category B. Clear of living quarters. Toxic if swallowed, by skin contact or by inhalation.	3248	
3248	MEDICINE, LIQUID, FLAMMABLE, TOXIC, N.O.S.	3	6.1	III	220 221 223	5 l	E1	P001	-	-	-	-	-	F-E, S-D	Category A.	See entry above.	3248
3249	MEDICINE, SOLID, TOXIC, N.O.S.	6.1	-	II	221	500 g	E4	P002	-	-	-	T3	TP33	F-A, S-A	Category C. Clear of living quarters. Toxic if swallowed, by skin contact or by dust inhalation.	3249	
3249	MEDICINE, SOLID, TOXIC, N.O.S.	6.1	-	III	221 223	5 kg	E1	P002 LP02	-	-	-	T1	TP33	F-A, S-A	Category C. Clear of living quarters. See entry above.	3249	
3250	CHLOROACETIC ACID, MOLTEN	6.1	8	II	-	0	E0	-	-	-	-	T7 TP28	TP3 TP28	F-A, S-B	Category C. Clear of living quarters. Molten liquid. Melting point may be as low as 50°C. Toxic if swallowed, by skin contact or by inhalation. Causes burns to skin, eyes and mucous membranes.	3250	
3251	ISOSORBIDE-5-MONONITRATE	4.1	-	III	226	5 kg	E1	P409	-	-	-	-	-	F-F, S-C	Category D. Protected from sources of ignition. Sensitive to strong detonation shock. Keep as cool as reasonably practicable. During transport, it shall be stored (or kept) in a cool ventilated place.	3251	
3252	DIFLUOROMETHANE (REFRIGERANT GAS R.32)	2.1	-	-	-	0	E0	P200	-	-	-	T50	-	F-D, S-U	Category D. Clear of living quarters. Flammable colourless gas. Heavier than air (1.8).	3252	
3253	SODIUM TRIOXOSULFATE	8	-	III	-	5 kg	E1	P002 LP02	-	IBC08	B3	T1	TP33	F-A, S-B	Category A. "Separated from" acids. Colourless hygroscopic solid. Dangerous reaction with oxidizers. In the presence of moisture, reacts with aluminum, zinc, tin and their compounds, evolving hydrogen, a flammable gas. Causes burns to skin, eyes and mucous membranes. Reacts violently with acids.	3253	
3254	TRIBUTYLPHOSPHANE	4.2	-	I	-	0	E0	P400	-	-	-	T21	TP2 TP7	F-A, S-M	Category D. "Separated from" CARBON TETRACHLORIDE (UN 1846). Colourless yellowish liquid. Insoluble in water. Strong garlic odour (phosphine). Liable to heat and ignite spontaneously in air. If involved in a fire evolves phosphine, a flammable and highly toxic gas. Reacts violently with oxidizing substances (peroxides, halogens, nitric oxides and carbon tetrachloride), initiating to mucous membranes.	3254	
3255	tert-BUTYL HYPOCHLORITE	4.2	8	I	76	0	E0	P099	-	-	-	-	-	F-A, S-M	Category D. Volatile flammable slightly yellow liquid with a pungent odour. Irritable to mucous membranes. Exposure to light causes immediate dangerous decomposition. Causes burns to skin, eyes and mucous membranes.	3255	

**TSFS 2015:66**  
**Bilaga 1**

UN No. (1)	PSN (2)	Class or Div (3)	Subsidiary Risk(s) (4)	Packing Group (5)	Special Provisions (6)	Limited quantities (7a)	Exempted quantities (7b)	Packing		IBC		Tank instructions (15)	Provisions (14)	Ems (15)	Stowage and Segregation (16)	Properties and Observations (17)	UN No. (18)
								Instruc-tions (8)	Provisions (9)	Instruc-tions (10)	Provisions (11)						
	3.1.2	2.0	2.0	2.0, 1.3	3.3	3.4	3.5	4.1, 4	4.1, 4	4.1, 4	4.1, 4	4.2, 4.3	4.2, 5, 4.3	7.8	7.1 to 7.7		
3256	ELEVATED TEMPERATURE LIQUID, FLAMMABLE, N.O.S. with flashpoint above 60°C, at or above its flash point.	3	-	III	274	0	EO	P099	-	IBC01	-	T3	TP2, TP29	F-E, S-D	Category A.	-	3256
3257	ELEVATED TEMPERATURE LIQUID, N.O.S. at or above 100°C and below its flashpoint (including molten metals, molten salts, etc)	9	-	III	272, 274	0	EO	P099	-	IBC01	-	T3	TP2, TP29	F-A, S-P	Category A. If under deck, in a mechanically ventilated space.	Any liquid which is transported at or above 100°C but below its flashpoint. May see fire if in contact with combustible material due to extreme temperature.	3257
3258	ELEVATED TEMPERATURE SOLID, N.O.S. at or above 240°C	9	-	III	272, 274	0	EO	P099	-	-	-	-	-	F-A, S-P	Category A. If under deck, in a mechanically ventilated space.	Any solid which is transported at or above 240°C. May cause fire if in contact with combustible material due to extreme temperature.	3258
3259	AMINES, SOLID, CORROSIVE, N.O.S. or POLYAMINES, SOLID, CORROSIVE, N.O.S.	8	-	I	274	0	EO	P002	-	IBC07	B1	T6	TP33	F-A, S-B	Category A. "Separated from" acids.	Colourless to yellowish solids with a pungent odour. Miscible with or soluble in water. When involved in a fire, evolve toxic gases. Corrosive to many metals. Causes burns to skin, eyes and mucous membranes. React violently with acids.	3259
3259	AMINES, SOLID, CORROSIVE, N.O.S. or POLYAMINES, SOLID, CORROSIVE, N.O.S.	8	-	II	274	1 kg	E2	P002	-	IBC08	B2, B4	T3	TP33	F-A, S-B	Category A. "Separated from" acids.	See entry above.	3259
3259	AMINES, SOLID, CORROSIVE, N.O.S. or POLYAMINES, SOLID, CORROSIVE, N.O.S.	8	-	III	272, 274	5 kg	E1	P002, LP02	-	IBC08	B3	T1	TP33	F-A, S-B	Category A. "Separated from" acids.	See entry above.	3259
3260	CORROSIVE SOLID, ACIDIC, INORGANIC, N.O.S.	8	-	I	274	0	EO	P002	-	IBC07	B1	T6	TP33	F-A, S-B	Category B.	Causes burns to skin, eyes and mucous membranes.	3260
3260	CORROSIVE SOLID, ACIDIC, INORGANIC, N.O.S.	8	-	II	274	1 kg	E2	P002	-	IBC08	B2, B4	T3	TP33	F-A, S-B	Category B.	See entry above.	3260
3260	CORROSIVE SOLID, ACIDIC, INORGANIC, N.O.S.	8	-	III	273, 274	5 kg	E1	P002, LP02	-	IBC08	B3	T1	TP33	F-A, S-B	Category A.	See entry above.	3260
3261	CORROSIVE SOLID, ACIDIC, ORGANIC, N.O.S.	8	-	I	274	0	EO	P002	-	IBC07	B1	T6	TP33	F-A, S-B	Category B.	Causes burns to skin, eyes and mucous membranes.	3261
3261	CORROSIVE SOLID, ACIDIC, ORGANIC, N.O.S.	8	-	II	274	1 kg	E2	P002	-	IBC08	B2, B4	T3	TP33	F-A, S-B	Category B.	See entry above.	3261
3261	CORROSIVE SOLID, ACIDIC, ORGANIC, N.O.S.	8	-	III	273, 274	5 kg	E1	P002, LP02	-	IBC08	B3	T1	TP33	F-A, S-B	Category A.	See entry above.	3261
3262	CORROSIVE SOLID, BASIC, INORGANIC, N.O.S.	8	-	I	274	0	EO	P002	-	IBC07	B1	T6	TP33	F-A, S-B	Category B. "Separated from" acids.	Causes burns to skin, eyes and mucous membranes.	3262
3262	CORROSIVE SOLID, BASIC, INORGANIC, N.O.S.	8	-	II	274	1 kg	E2	P002	-	IBC08	B2, B4	T3	TP33	F-A, S-B	Category B. "Separated from" acids.	See entry above.	3262
3262	CORROSIVE SOLID, BASIC, INORGANIC, N.O.S.	8	-	III	273, 274	5 kg	E1	P002, LP02	-	IBC08	B3	T1	TP33	F-A, S-B	Category A. "Separated from" acids.	See entry above.	3262
3263	CORROSIVE SOLID, BASIC, ORGANIC, N.O.S.	8	-	I	274	0	EO	P002	-	IBC07	B1	T6	TP33	F-A, S-B	Category B. "Separated from" acids.	Causes burns to skin, eyes and mucous membranes.	3263



UN No. (1)	PSN (2)	Class of Div (3)	Subsidiary Risk(s) (4)	Packing Group (5)	Special Provisions (6)	Limited quantities (7a)	Excepted quantities (7b)	Packing			IBC			
								Instruc-tions (8)	Instruc-tions (9)	Instruc-tions (10)	Provisions (11)	Instruc-tions (12)	Provisions (13)	Instruc-tions (14)
	3.1.2	2.0	2.0	2.0, 1.3	3.3	3.4	3.5	4.1, 4	4.1, 4	4.1, 4	4.1, 4	4.1, 4	4.1, 4	4.1, 4

UN No. (1)	PSN (2)	Class of Div (3)	Subsidiary Risk(s) (4)	Packing Group (5)	Special Provisions (6)	Limited quantities (7a)	Excepted quantities (7b)	Packing			IBC		
								Instruc-tions (8)	Instruc-tions (9)	Instruc-tions (10)	Provisions (11)	Instruc-tions (12)	Provisions (13)
3263	CORROSIVE SOLID, BASIC-ORGANIC, N.O.S.	8	-	II	274	1 kg	E2	P002	-	IBC08	B2	B4	

Category B. "Separated from" acids. See entry above. 3263

3263	CORROSIVE SOLID, BASIC-ORGANIC, N.O.S.	8	-	III	223 274	5 kg	E1	P002 LP02	-	IBC08	B3		
------	--	---	---	-----	------------	------	----	--------------	---	-------	----	--	--

Category A. "Separated from" acids. See entry above. 3263

3264	CORROSIVE LIQUID, ACIDIC, INORGANIC, N.O.S.	8	-	I	274	0	EO	P001	-	-	-	-	
------	---	---	---	---	-----	---	----	------	---	---	---	---	--

Category B. Clear of living quarters. Causes burns to skin, eyes and mucous membranes. 3264

3264	CORROSIVE LIQUID, ACIDIC, INORGANIC, N.O.S.	8	-	II	274	1 ℓ	E2	P001	-	IBC02	-	-	
------	---	---	---	----	-----	-----	----	------	---	-------	---	---	--

Category B. Clear of living quarters. See entry above. 3264

3264	CORROSIVE LIQUID, ACIDIC, INORGANIC, N.O.S.	8	-	III	223 274	5 ℓ	E1	P001 LP01	-	IBC03	-	-	
------	---	---	---	-----	------------	-----	----	--------------	---	-------	---	---	--

Category A. Clear of living quarters. See entry above. 3264

3265	CORROSIVE LIQUID, ACIDIC, ORGANIC, N.O.S.	8	-	I	274	0	EO	P001	-	-	-	-	
------	---	---	---	---	-----	---	----	------	---	---	---	---	--

Category B. Clear of living quarters. Causes burns to skin, eyes and mucous membranes. 3265

3265	CORROSIVE LIQUID, ACIDIC, ORGANIC, N.O.S.	8	-	II	274	1 ℓ	E2	P001	-	IBC02	-	-	
------	---	---	---	----	-----	-----	----	------	---	-------	---	---	--

Category B. Clear of living quarters. See entry above. 3265

3265	CORROSIVE LIQUID, ACIDIC, ORGANIC, N.O.S.	8	-	III	223 274	5 ℓ	E1	P001 LP01	-	IBC03	-	-	
------	---	---	---	-----	------------	-----	----	--------------	---	-------	---	---	--

Category A. Clear of living quarters. See entry above. 3265

3266	CORROSIVE LIQUID, BASIC, INORGANIC, N.O.S.	8	-	I	274	0	EO	P001	-	-	-	-	
------	--	---	---	---	-----	---	----	------	---	---	---	---	--

Category B. Clear of living quarters. Reacts violently with acids. Causes burns to skin, eyes and mucous membranes. 3266

3266	CORROSIVE LIQUID, BASIC, INORGANIC, N.O.S.	8	-	II	274	1 ℓ	E2	P001	-	IBC02	-	-	
------	--	---	---	----	-----	-----	----	------	---	-------	---	---	--

Category B. Clear of living quarters. See entry above. 3266

3266	CORROSIVE LIQUID, BASIC, INORGANIC, N.O.S.	8	-	III	223 274	5 ℓ	E1	P001 LP01	-	IBC03	-	-	
------	--	---	---	-----	------------	-----	----	--------------	---	-------	---	---	--

Category A. Clear of living quarters. See entry above. 3266

3267	CORROSIVE LIQUID, BASIC, ORGANIC, N.O.S.	8	-	I	274	0	EO	P001	-	-	-	-	
------	--	---	---	---	-----	---	----	------	---	---	---	---	--

Category B. Clear of living quarters. Reacts violently with acids. Causes burns to skin, eyes and mucous membranes. 3267

3267	CORROSIVE LIQUID, BASIC, ORGANIC, N.O.S.	8	-	II	274	1 ℓ	E2	P001	-	IBC02	-	-	
------	--	---	---	----	-----	-----	----	------	---	-------	---	---	--

Category B. Clear of living quarters. See entry above. 3267

3267	CORROSIVE LIQUID, BASIC, ORGANIC, N.O.S.	8	-	III	223 274	5 ℓ	E1	P001 LP01	-	IBC03	-	-	
------	--	---	---	-----	------------	-----	----	--------------	---	-------	---	---	--

Category A. Clear of living quarters. See entry above. 3267

3268	AIR BAG INFLATORS or AIR BAG MODULES or SEAT-BELT PRE-TENSIONERS	9	-	III	280 289	0	EO	P002 LP002	-	-	-	-	
------	--	---	---	-----	------------	---	----	---------------	---	---	---	---	--

Category A. 3268

**TSFS 2015:66**  
**Bilaga 1**

UN No. (1)	PSN (2)	Class or Div (3)	Subsidiary Risk(s) (4)	Packing Group (5)	Special Provisions (6)	Limited quantities (7a)	Excepted quantities (7b)	Packing			IBC	
								Instruc-tions (8)	Instruc-tions (9)	Instruc-tions (10)	Provisions (11)	
3.1.2		2.0	2.0	2.0, 1.3	3.3	3.4	3.5	4.1, 4	4.1, 4	4.1, 4	4.1, 4	

Tank instructions (15)	Provisions (14)	EMs (15)	Storage and Segregation (16)	Properties and Observations (17)	UN No. (18)

3269 POLYESTER RESIN KIT 3 - - II 236 340 5 ℓ See SP340 P302 - - - - - Polyester resin kits consist of two components, a base material and a hardener/activator (organic peroxide), each separately packed in an inner packaging. 3269

3269 POLYESTER RESIN KIT 3 - - III 236 340 5 ℓ See SP340 P302 - - - - - See entry above. 3269

3270 NITROCELLULOSE MEMBRANE FILTERS with not more than 12.6% nitrogen, by dry mass 4.1 - - II 237 286 1 kg E2 P411 - - - - - Filters may be small round pieces or large sheets. When involved in a fire, explosive fumes are produced from these items. These items form an explosive mixture with air. Burns rapidly with intense heat radiation. 3270

3271 ETHERS, N.O.S. 3 - - II 274 274 1 ℓ E2 P001 - IBC02 - - - - - TP1 TP8 TP28 TP28 Category B. 3271

3271 ETHERS, N.O.S. 3 - - III 223 274 5 ℓ E1 P001 LP01 - IBC03 - - - - - TP1 TP29 Category A. 3271

3272 ESTERS, N.O.S. 3 - - II 274 274 1 ℓ E2 P001 - IBC02 - - - - - TP1 TP8 TP28 TP28 Category B. 3272

3272 ESTERS, N.O.S. 3 - - III 223 274 5 ℓ E1 P001 LP01 - IBC03 - - - - - TP1 TP29 Category A. 3272

3273 NITRILES, FLAMMABLE, TOXIC, N.O.S. 3 6.1 I 274 0 E0 P001 - - - - - TP14 TP2 TP3 TP27 F-E, S-D Category E. Clear of living quarters. Liquids evolving toxic vapour. React with acids or acid fumes, evolving hydrogen cyanide, a highly toxic and flammable gas. Toxic if swallowed, by skin contact or by inhalation. 3273

3273 NITRILES, FLAMMABLE, TOXIC, N.O.S. 3 6.1 II 274 1 ℓ E2 P001 - IBC02 - - - - - TP2 TP3 TP27 F-E, S-D Category B. Clear of living quarters. See entry above. 3273

3274 ALCOHOLATES SOLUTION, N.O.S. in alcohol 3 8 II 274 1 ℓ E2 P001 - IBC02 - - - - - F-E, S-C Category B. Colourless solution. Reacts violently with water. Causes burns to skin, eyes and mucous membranes. 3274

3275 NITRILES, TOXIC, FLAMMABLE, N.O.S. 6.1 3 I 274 0 E5 P001 - - - - - TP2 TP27 F-E, S-D Category B. Clear of living quarters. React with acids or acid fumes, evolving hydrogen cyanide, a highly toxic and flammable gas. Miscible with water. Toxic if swallowed, by skin contact or by inhalation. 3275

3275 NITRILES, TOXIC, FLAMMABLE, N.O.S. 6.1 3 II 274 100 ml<sup>l</sup> E4 P001 - IBC02 - - - - - TP2 TP3 TP27 F-E, S-D Category B. Clear of living quarters. See entry above. 3275

3276 NITRILES, LIQUID, TOXIC, N.O.S. 6.1 - - I 274 315 0 E5 P001 - - - - - TP2 TP3 TP27 F-A, S-A Category B. "Separated from" acids. Liquids evolving toxic vapour. React with acids or acid fumes, evolving hydrogen cyanide, a highly toxic and flammable gas. Miscible with water. Toxic if swallowed, by skin contact or by inhalation. 3276

3276 NITRILES, LIQUID, TOXIC, N.O.S. 6.1 - - II 274 100 ml<sup>l</sup> E4 P001 - IBC02 - - - - - TP2 TP27 F-A, S-A Category B. "Separated from" acids. See entry above. 3276

UN No. (1)	PSN (2)	Class No. (3)	Subsidiary Risk(s) (4)	Packing Group (5)	Special Provisions (6)	Limited quantities (7a)	Excepted quantities (7b)	Packing			IBC			Provisions (15)	EMs (15)	Storage and Segregation (16)	Properties and Observations (17)	UN No. (18)
								Instruc-tions (8)	Provisions (9)	Instruc-tions (10)	Provisions (11)	Tank instructions (12)	Provisions (13)					
3276	NITRILES, LIQUID, TOXIC, N.O.S.	6.1	-	III	223 274	5 ℓ	E1	P001 LP01	-	IBC03	-	-	T7 TP1 TP28	F-A, S-A	Category A. *Separated from* acids. See entry above.			3276
3277	CHLOROFORMATES, TOXIC, CORROSIVE, N.O.S.	6.1	8	II	274	100 ml	E4	P001	-	IBC02	-	-	T8 TP2 TP3 TP28	F-A, S-B	Category A. Keep as cool and dry as possible. Do not mix with water or other liquids. Protected from sources of heat. Clear of living quarters.	Reacts and decomposes with water or heat, evolving hydrogen chloride, an irritant gas. See entry above. Toxic if swallowed, by skin contact or by inhalation. Cause burns to skin, eyes and mucous membranes.	3277	
3278	ORGANOPHOSPHORUS COMPOUND, LIQUID, TOXIC, N.O.S.	6.1	-	I	43 274 315	0	E5	P001	-	-	-	-	T14 TP2 TP3 TP27	F-A, S-A	Category B.	Toxic if swallowed, by skin contact or by inhalation.	3278	
3278	ORGANOPHOSPHORUS COMPOUND, LIQUID, TOXIC, N.O.S.	6.1	-	II	43 274	100 ml	E4	P001	-	IBC02	-	-	T11 TP2 TP27	F-A, S-A	Category B.	See entry above.	3278	
3278	ORGANOPHOSPHORUS COMPOUND, LIQUID, TOXIC, N.O.S.	6.1	-	III	43 223 274	5 ℓ	E1	P001 LP01	-	IBC03	-	-	T7 TP1 TP28	F-A, S-A	Category A.	See entry above.	3278	
3279	ORGANOPHOSPHORUS COMPOUND, TOXIC, FLAMMABLE N.O.S.	6.1	3	I	43 274 315	0	E5	P001	-	-	-	-	T14 TP2 TP3 TP27	F-E, S-D	Category B. Clear of living quarters.	A wide variety of toxic flammable liquids. Toxic if swallowed, by skin contact or by inhalation.	3279	
3279	ORGANOPHOSPHORUS COMPOUND, TOXIC, FLAMMABLE N.O.S.	6.1	3	II	43 274	100 ml	E4	P001	-	-	-	-	T11 TP2 TP3 TP27	F-E, S-D	Category B. Clear of living quarters.	See entry above.	3279	
3280	ORGANARSENIC COMPOUND, LIQUID, N.O.S.	6.1	-	I	274 315	0	E5	P001	-	-	-	-	T14 TP2 TP3 TP27	F-A, S-A	Category B.	Toxic if swallowed, by skin contact or by inhalation.	3280	
3280	ORGANARSENIC COMPOUND, LIQUID, N.O.S.	6.1	-	II	274	100 ml	E4	P001	-	IBC02	-	-	T11 TP2 TP27	F-A, S-A	Category B.	See entry above.	3280	
3280	ORGANARSENIC COMPOUND, LIQUID, N.O.S.	6.1	-	III	223 274	5 ℓ	E1	P001 LP01	-	IBC03	-	-	T7 TP1 TP28	F-A, S-A	Category A.	See entry above.	3280	
3281	METAL CARBONYLS, LIQUID, N.O.S.	6.1	-	I	274 315	0	E5	P601	-	-	-	-	T14 TP2 TP3 TP27	F-A, S-A	Category D. Clear of living quarters.	A range of metal carbonyls which, when heated, can give off carbon monoxide. Insoluble in water. Immiscible with water. Toxic if swallowed, by skin contact or by inhalation.	3281	
3281	METAL CARBONYLS, LIQUID, N.O.S.	6.1	-	II	274	100 ml	E4	P001	-	IBC02	-	-	T11 TP2 TP27	F-A, S-A	Category B. Clear of living quarters.	See entry above.	3281	
3281	METAL CARBONYLS, LIQUID, N.O.S.	6.1	-	III	223 274	5 ℓ	E1	P001 LP01	-	IBC03	-	-	T7 TP1 TP28	F-A, S-A	Category B. Clear of living quarters.	See entry above.	3281	
3282	ORGANOMETALLIC COMPOUND, LIQUID, TOXIC, N.O.S.	6.1	-	I	274	0	E5	P001	-	-	-	-	T14 TP2 TP3 TP27	F-A, S-A	Category B.	Toxic if swallowed, by skin contact or by inhalation.	3282	

UN No. (1)	PSN (2)	Class or Div (5)	Subsidiary Risk(s) (4)	Packing Group (3)	Special Provisions (6)	Limited quantities (7a)	Excepted quantities (7b)	Packing			IBC	
								Instruc-tions (8)	Provisions (9)	Instruc-tions (10)	Provisions (11)	
312		2.0	2.0	2.0	1.3	3.3	3.4	3.5	4.1, 4	4.1, 4	4.1, 4	

3282 ORGANOMETALLIC COMPOUND, LIQUID, TOXIC, N.O.S. 6.1 - II 274 100 ml E4 P001 - IBC02 - 3282

3282 ORGANOMETALLIC COMPOUND, LIQUID, TOXIC, N.O.S. 6.1 - III 223 274 5 l E1 P001 LPO1 - IBC03 - 3282

3283 SELENIUM COMPOUND, SOLID, N.O.S. 6.1 - I 274 0 E5 P002 - IBC07 B1 - 3283

3283 SELENIUM COMPOUND, SOLID, N.O.S. 6.1 - II 274 500 g E4 P002 - IBC08 B2 B4 - 3283

3283 SELENIUM COMPOUND, SOLID, N.O.S. 6.1 - III 223 274 5 kg E1 P002 LPO2 - IBC08 B3 - 3283

3284 TELLURIUM COMPOUND, N.O.S. 6.1 - I 274 0 E5 P002 - IBC07 B1 - 3284

3284 TELLURIUM COMPOUND, N.O.S. 6.1 - II 274 500 g E4 P002 - IBC08 B2 B4 - 3284

3284 TELLURIUM COMPOUND, N.O.S. 6.1 - III 223 274 5 kg E1 P002 LPO2 - IBC08 B3 - 3284

3285 VANADIUM COMPOUND, N.O.S. 6.1 - I 274 0 E5 P002 - IBC07 B1 - 3285

3285 VANADIUM COMPOUND, N.O.S. 6.1 - II 274 500 g E4 P002 - IBC08 B2 B4 - 3285

3285 VANADIUM COMPOUND, N.O.S. 6.1 - III 223 274 5 kg E1 P002 LPO2 - IBC08 B3 - 3285

3286 FLAMMABLE LIQUID, TOXIC, CORROSIVE, N.O.S. 3 6.1/8 I 274 0 E0 P001 - - - - - 3286

3286 FLAMMABLE LIQUID, TOXIC, CORROSIVE, N.O.S. 3 6.1/8 II 274 1 l E2 P001 - IBC99 - - - - - 3286

3287 TOXIC LIQUID, INORGANIC, N.O.S. 6.1 - I 274 315 E5 P001 - - - - - 3287

3287 TOXIC LIQUID, INORGANIC, N.O.S. 6.1 - II 274 100 ml E4 P001 - IBC02 - - - - - 3287

Tank instructions (15)	Provisions (14)	EMs (15)	Stowage and Segregation (16)	Properties and Observations (17)	UN No. (18)
4.2.5 4.3	4.2.5	5.4.5.2 7.8	7.1 to 7.7		3282

3282 ORGANOMETALLIC COMPOUND, LIQUID, TOXIC, N.O.S. 6.1 - III 223 274 5 l E1 P001 LPO1 - IBC03 - 3282

3282 ORGANOMETALLIC COMPOUND, LIQUID, TOXIC, N.O.S. 6.1 - III 223 274 5 l E1 P001 LPO1 - IBC03 - 3282

3283 SELENIUM COMPOUND, SOLID, N.O.S. 6.1 - I 274 0 E5 P002 - IBC07 B1 - 3283

3283 SELENIUM COMPOUND, SOLID, N.O.S. 6.1 - II 274 500 g E4 P002 - IBC08 B2 B4 - 3283

3283 SELENIUM COMPOUND, SOLID, N.O.S. 6.1 - III 223 274 5 kg E1 P002 LPO2 - IBC08 B3 - 3283

3284 TELLURIUM COMPOUND, N.O.S. 6.1 - I 274 0 E5 P002 - IBC07 B1 - 3284

3284 TELLURIUM COMPOUND, N.O.S. 6.1 - II 274 500 g E4 P002 - IBC08 B2 B4 - 3284

3284 TELLURIUM COMPOUND, N.O.S. 6.1 - III 223 274 5 kg E1 P002 LPO2 - IBC08 B3 - 3284

3285 VANADIUM COMPOUND, N.O.S. 6.1 - I 274 0 E5 P002 - IBC07 B1 - 3285

3285 VANADIUM COMPOUND, N.O.S. 6.1 - II 274 500 g E4 P002 - IBC08 B2 B4 - 3285

3285 VANADIUM COMPOUND, N.O.S. 6.1 - III 223 274 5 kg E1 P002 LPO2 - IBC08 B3 - 3285

3286 FLAMMABLE LIQUID, TOXIC, CORROSIVE, N.O.S. 3 6.1/8 I 274 0 E0 P001 - - - - - 3286

3286 FLAMMABLE LIQUID, TOXIC, CORROSIVE, N.O.S. 3 6.1/8 II 274 1 l E2 P001 - IBC99 - - - - - 3286

3287 TOXIC LIQUID, INORGANIC, N.O.S. 6.1 - I 274 315 E5 P001 - - - - - 3287

3287 TOXIC LIQUID, INORGANIC, N.O.S. 6.1 - II 274 100 ml E4 P001 - IBC02 - - - - - 3287

UN No. (1)	PSN (2)	Class No. (3)	Subsidiary Risk(s) (4)	Packing Group (5)	Special Provisions (6)	Limited quantities (7a)	Excepted quantities (7b)	Packing		IBC	
								Instructions (8)	Provisions (9)	Instructions (10)	Provisions (11)
3.1.2		2.0	2.0	2.0, 1.3	3.3	3.4	3.5	4.1, 4	4.1, 4	4.1, 4	
6.1	-	III	223 274			5 ℓ	E1	P001 LP01	-	IBC03	-

UN No. (16)	Properties and Observations (17)	Storage and Segregation (16)	Portable tanks and bulk containers	
			Tank instructions (15)	Provisions (14)
		7.1 to 7.7	4.2, 5 4.3	4.2, 5 7.8
3287			T7 TP1 TP8	F-A, S-A Category A. Clear of living quarters. See entry above.

3288	TOXIC SOLID, INORGANIC, N.O.S.	6.1	-	I	274	0	ES	P002	-	IBC59	-	TP33	F-A, S-A Category B.	Toxic if swallowed, by skin contact or by inhalation.	3288
3288	TOXIC SOLID, INORGANIC, N.O.S.	6.1	-	II	274	500 g	E4	P002	-	IBC08 B2 B4		T3	TP33 F-A, S-A Category B.	See entry above.	3288
3288	TOXIC SOLID, INORGANIC, N.O.S.	6.1	-	III	223 274	5 kg	E1	P002 LP02	-	IBC08 B3		T1	TP33 F-A, S-A Category A.	See entry above.	3288
3289	TOXIC LIQUID, CORROSIVE, INORGANIC, N.O.S.	6.1	8	I	274 315	0	ES	P001	-	-		T1.4 TP2 TP3 TP7	F-A, S-B Category B. Clear of living quarters.	Toxic if swallowed, by skin contact or by inhalation. Causes burns to skin, eyes and mucous membranes.	3289
3289	TOXIC LIQUID, CORROSIVE, INORGANIC, N.O.S.	6.1	8	II	274	100 ml	E4	P001	-	IBC02		T1.1 TP2 TP27	F-A, S-B Category B. Clear of living quarters.	See entry above.	3289
3290	TOXIC SOLID, CORROSIVE, INORGANIC, N.O.S.	6.1	8	I	274	0	ES	P002	-	IBC59		T6	TP33 F-A, S-B Category B. Clear of living quarters.	Toxic if swallowed, by skin contact or by inhalation. Causes burns to skin, eyes and mucous membranes.	3290
3290	TOXIC SOLID, CORROSIVE, INORGANIC, N.O.S.	6.1	8	II	274	500 g	E4	P002	-	IBC06 B2		T3	TP33 F-A, S-B Category B. Clear of living quarters.	See entry above.	3290
3291	CLINICAL WASTE (UNSPECIFIED), N.O.S. or (BIO) MEDICAL WASTE, N.O.S. or REGULATED MEDICAL WASTE, N.O.S.	6.2	-	II	-	0	E0	PE21 LP621	-	IBC620		BIK2	F-A, S-T As approved by the competent authority of the country of origin.	Derived from the medical treatment of animals, humans or from bio-research.	3291
3292	BATTERIES CONTAINING SODIUM or CELLS, CONTAINING SODIUM	4.3	-	II	239	0	E0	P408	-	-		-	F-G, S-P Category A.	Series of hermetically sealed metal cells containing sodium, electrically connected and secured within a metal casing. "Cold" batteries (batteries containing elemental sodium only in the solid state) are electrically inert. Batteries are activated by heating to between 300°C and 350°C before use. Sodium reacts violently with water. Sodium hydroxide is present in the terminals. Batteries or cells should not be offered for transport at a temperature such that liquid elemental sodium is present in the battery or cell (unless approved), and under conditions of transport established by the competent authority.	3292
3293	HYDRAZINE, AQUEOUS SOLUTION with not more than 3% hydrazine, by mass	6.1	-	III	223	5 ℓ	E1	P001 LP01	-	IBC03		T4	TP1 F-A, S-A Category A. "Separated from" acids.	Colourless liquid. Reacts violently with acids. Toxic if swallowed, by skin contact or by inhalation.	3293
3294	HYDROGEN CYANIDE, SOLUTION IN ALCOHOL with not more than 45% hydrogen cyanide	6.1	3 P	I	900	0	ES	P601	-	-		T1.4 TP3	F-E, S-D Category D. Clear of living quarters.	Flammable solution, evolving extremely toxic flammable vapours. Miscible with water. Highly toxic if swallowed, by skin contact or by inhalation. Transport of HYDROGEN CYANIDE, SOLUTION IN ALCOHOL with more than 4.5% hydrogen cyanide is prohibited.	3294
3295	HYDROCARBONS, LIQUID, N.O.S.	3	-	I	-	500 ml	E3	P001	-	-		T1.1 TP8 TP28	F-E, S-D Category E.	Immiscible with water.	3295
3295	HYDROCARBONS, LIQUID, N.O.S.	3	-	II	-	1 ℓ	E2	P001	-	IBC02		T7 TP1 TP8 TP28	F-E, S-D Category B.	See entry above.	3295

**TSFS 2015:66**  
**Bilaga 1**

MSC 90/28/AdL3  
ANNEX 4  
Page 173

MSC 90/28/AdL3  
ANNEX 4  
Page 173

UN No. (1)	PSN (2)	Class No. (5)	Subsidiary Risk(s) (4)	Packing Group (3)	Special Provisions (6)	Limited quantities (7a)	Excepted quantities (7b)	Packing		IBC		Tank instructions (15)	Provisions (14)	EMs (15)	Stowage and Segregation (16)	Properties and Observations (17)	UN No. (18)
								Instructions (8)	Provisions (9)	Instructions (10)	Provisions (11)						
	3.1.2	2.0	2.0	2.0, 1.3	3.3	3.4	3.5	4.1, 4	P001 LP01	IBC03	T4	TP1 TP2	F-E, S-D	Category A.	See entry above.	3295	
3295	HYDROCARBONS, LIQUID, N.O.S.	3	-	III	223	5 l	EI	P001 LP01	-	IBC03	-	-	F-E, S-D	Category A.	See entry above.	3295	
3296	HEPTAFLUOROPROPANE (REFRIGERANT GAS R 227)	2.2	-	-	-	120 ml	EI	P200	-	-	T50	-	F-C, S-V	Category A.	Non-flammable compressed gas. Heavier than air (1.4).	3296	
3297	ETHYLENE OXIDE AND CHLOROTETRAFLUOROETHANE MIXTURE with not more than 8.8% ethylene oxide	2.2	-	-	-	120 ml	EI	P200	-	-	T50	-	F-C, S-V	Category A.	Liquefied, non-flammable, colourless gas with an ether-like odour. Much heavier than air.	3297	
3298	ETHYLENE OXIDE AND PENTAFLUROETHANE MIXTURE with not more than 7.9% ethylene oxide	2.2	-	-	-	120 ml	EI	P200	-	-	T50	-	F-C, S-V	Category A.	Liquefied, non-flammable, colourless gas with an ether-like odour. Much heavier than air.	3298	
3299	ETHYLENE OXIDE AND TETRAFLUROETHANE MIXTURE with not more than 5.6% ethylene oxide	2.2	-	-	-	120 ml	EI	P200	-	-	T50	-	F-C, S-V	Category A.	Liquefied, non-flammable, colourless gas with an ether-like odour. Much heavier than air.	3299	
3300	ETHYLENE OXIDE AND CARBON DIOXIDE MIXTURE with more than 87% ethylene oxide	2.3	2.1	-	-	0	EO	P200	-	-	-	-	F-D, S-U	Category D.	Liquefied, flammable, toxic colourless gas with an ether-like odour. Heavier than air (1.5).	3300	
3301	CORROSIVE LIQUID, SELF-HEATING, N.O.S.	8	4.2	I	274	0	EO	P001	-	-	-	-	F-A, S-J	Category D.	Causes burns to skin, eyes and mucous membranes.	3301	
3301	CORROSIVE LIQUID, SELF-HEATING, N.O.S.	8	4.2	II	274	0	E2	P001	-	-	-	-	F-A, S-J	Category D.	See entry above.	3301	
3302	2-DIMETHYLAMINOETHYL ACRYLATE	6.1	-	II	-	100 ml	E4	P001	-	IBC02	T7	TP2	F-A, S-A	Category D.	Colourless to light yellow liquid. Acrid odour. Miscible with water. Causes burns, stabilized with hydroquinone derivatives. Hydrolyses in water to form dimethylaminoethanol. Toxic if swallowed, by skin contact or by inhalation.	3302	
3303	COMPRESSED GAS, TOXIC, OXIDIZING, N.O.S.	2.3	5.1	-	274	0	EO	P200	-	-	-	-	F-C, S-W	Category D.	Clear of living quarters.	3303	
3304	COMPRESSED GAS, TOXIC, CORROSIVE, N.O.S.	2.3	8	-	274	0	EO	P200	-	-	-	-	F-C, S-U	Category D.	Clear of living quarters.	3304	
3305	COMPRESSED GAS, TOXIC, FLAMMABLE, CORROSIVE, N.O.S.	2.3	2.1/8	-	274	0	EO	P200	-	-	-	-	F-D, S-U	Category D.	Clear of living quarters. Segregation as for class 2.1 but "Away from" class 4.3.	3305	
3306	COMPRESSED GAS, TOXIC, OXIDIZING, CORROSIVE, N.O.S.	2.3	5.1/8	-	274	0	EO	P200	-	-	-	-	F-C, S-W	Category D.	Clear of living quarters. Segregation as for class 3.1 but "Separated from" class 7.	3306	
3307	LIQUEFIED GAS, TOXIC, OXIDIZING, N.O.S.	2.3	5.1	-	274	0	EO	P200	-	-	-	-	F-C, S-W	Category D.	Clear of living quarters.	3307	
3308	LIQUEFIED GAS, TOXIC, CORROSIVE, N.O.S.	2.3	8	-	274	0	EO	P200	-	-	-	-	F-C, S-U	Category D.	Clear of living quarters.	3308	
3309	LIQUEFIED GAS, TOXIC, FLAMMABLE, CORROSIVE, N.O.S.	2.3	2.1/8	-	274	0	EO	P200	-	-	-	-	E, D, S-U	Category D.	Clear of living quarters. Segregation as for class 2.1 but "Away from" class 4.3.	3309	
3310	LIQUEFIED GAS, TOXIC, OXIDIZING, CORROSIVE, N.O.S.	2.3	5.1/8	-	274	0	EO	P200	-	-	-	-	F-C, S-W	Category D.	Clear of living quarters. Segregation as for class 3.1 but "Separated from" class 7.	3310	

UN No. (1)	PSN (2)	Class or Div (3)	Subsidiary Risk(s) (4)	Packing Group (5)	Special Provisions (6)	Limited quantities (7a)	Excepted quantities (7b)	Packing		IBC		Portable tanks and bulk containers		EMs (15)	Stowage and Segregation (16)	UN No. (18)	Properties and Observations (17)
								Institutions (8)	Provisions (9)	Institutions (10)	Provisions (11)	Tank instructions (12)	Provisions (13)				
3.1.2		2.0	2.0	2.0, 1.3	3.3	3.4	3.5	4.1, 4	4.1, 4	4.1, 4	4.1, 4	4.2, 5	4.2, 5	54, 5, 2	7.1 to 7.7		
3311	GAS, REFRIGERATED LIQUID, OXIDIZING, N.O.S.	2.2	5.1	-	274	0	EO	P203	-	-	-	T75	TP5	F-C, S-W	Category D.	-	3311
3312	GAS, REFRIGERATED LIQUID, FLAMMABLE, N.O.S.	2.1	-	-	274	0	EO	P203	-	-	-	T75	TP5	E-D, S-U	Category D.	Clear of living quarters.	3312
3313	ORGANIC PIGMENTS, SELF-HEATING	4.2	-	II	-	0	E2	P002	-	IBC08	B2 B4	T3	TP33	F-A, S-J	Category C.	Self-heating coloured powder or granules. Odourless. Liable to self-heating or spontaneous combustion.	3313
3313	ORGANIC PIGMENTS, SELF-HEATING	4.2	-	III	223	0	E1	P002	LPO2	IBC08	B3	T1	TP33	F-A, S-J	Category C.	See entry above.	3313
3314	PLASTICS MOULDING COMPOUND in dough, sheet or extruded rope form, evolving flammable vapour	9	-	III	207, 965	5 kg	E1	P002	PP1, 4	IBC08	B3 B6	BK2	-	F-A, S-I	Category E.	Protected from sources of heat. When stored under-deck, the cargo must be segregated in accordance with SOLAS regulation II-2/19 (II-2/54) for flammable liquids with flashpoint below 23°C (see Segregation as for class 3 but see also class 1 except division 1.4.5).	3314
3315	CHEMICAL SAMPLE, TOXIC	6.1	-	I	250	0	E5	P099	-	-	-	-	-	F-A, S-A	Category D.	Clear of living quarters.	3315
3316	CHEMICAL KIT or FIRST AID KIT	9	-	-	251	See SP251	See SP340	P901	-	-	-	-	-	F-A, S-P	Category A.	-	3316
3317	2-AMINO-4,6-DINITROPHENOL, WETTED with not less than 20% water, by mass	4.1	-	I	28	0	EO	P406	PP26 PP51	-	-	-	-	F-8, S-J	Category D.	"Away from" class 3 and heavy metals and their salts. When involved in a fire, evolves toxic fumes; in closed compartments these fumes may form an explosive mixture with air. Harmful if swallowed or by-skin contact.	3317
3318	AMMONIA SOLUTION relative density/less than 0.880 at 15°C in water, with more than 50% ammonia	2.3	8	-	23	0	EO	P200	-	-	-	T50	-	F-C, S-U	Category D.	Clear of living quarters. "Separated from" chlorine and acids.	3318
3319	NITROGLYCERIN MIXTURE, DISPERSED, SOLID, N.O.S. with more than 2% but not more than 10% nitroglycerin, by mass	4.1	-	II	272 274	0	EO	P099	-	-	-	-	-	F-8, S-J	Category E.	Deagglomerated explosives with lactose, glucose or cellulose. White solid. Soluble in water. When involved in a fire the nitroglycerin may accumulate and may produce an explosion. Contact with water may dissolve the desensitizer (lactose or glucose) causing migration and accumulation of the nitroglycerin which may explode. Nitroglycerin is more dense than water. The nitroglycerin may form an explosive mixture with air. Inhalation of vapours may cause headaches, dizziness and fainting.	3319
3320	SODIUM BOROHYDRIDE AND SODIUM HYDROXIDE SOLUTION with not more than 12% sodium borohydride and not more than 40% sodium hydroxide, by mass	8	-	II	-	1 ℓ	E2	P001	-	IBC02	-	T7	TP2	F-A, S-B	Category A.	"Separated from" acids.	3320
3320	SODIUM BOROHYDRIDE AND SODIUM HYDROXIDE SOLUTION with not more than 12% sodium borohydride and not more than 40% sodium hydroxide, by mass	8	-	III	223	5 ℓ	E1	P001	LPO1	IBC03	-	T4	TP2	F-A, S-B	Category A.	"Separated from" acids. See entry above.	3320

UN No. (1)	PSN (2)	Class of Div. (3)	Subsidiary Risk(s) (4)	Packing Group (5)	Special Provisions (6)	Limited quantities (7a)	Excepted quantities (7b)	Packing		IBC	
								Instruc-tions (8)	Provisions (9)	Instruc-tions (10)	Provisions (11)
31.2		2.0	2.0	2.0, 1.3	3.3	3.4	3.5	4.1, 4	4.1, 4	4.1, 4	4.1, 4

3321 RADIOACTIVE MATERIAL, LOW SPECIFIC ACTIVITY (LSA-II), non fissile or fissile excepted  
7 See SP72 - 172 0 EO See 4.1.9 See 4.1.9 See 4.1.9 See 4.1.9  
317 317 325

3322 RADIOACTIVE MATERIAL, LOW SPECIFIC ACTIVITY (LSA-III), non fissile or fissile excepted  
7 See SP72 - 172 0 EO See 4.1.9 See 4.1.9 See 4.1.9 See 4.1.9  
317 317 325

3323 RADIOACTIVE MATERIAL, TYPE C PACKAGE, non fissile or fissile excepted  
7 See SP72 - 172 0 EO See 4.1.9 See 4.1.9 See 4.1.9 See 4.1.9  
317 317 325

3324 RADIOACTIVE MATERIAL, LOW SPECIFIC ACTIVITY (LSA-III), FISSILE  
7 See SP72 - 172 0 EO See 4.1.9 See 4.1.9 See 4.1.9 See 4.1.9  
317 317 326

3325 RADIOACTIVE MATERIAL, LOW SPECIFIC ACTIVITY (LSA-III), FISSILE  
7 See SP72 - 172 0 EO See 4.1.9 See 4.1.9 See 4.1.9 See 4.1.9  
317 317 326

3326 RADIOACTIVE MATERIAL, SURFACE CONTAMINATED OBJECTS (SCO-I or SCO-II), FISSILE  
7 See SP72 - 172 0 EO See 4.1.9 See 4.1.9 See 4.1.9 See 4.1.9  
317 317 326

3327 RADIOACTIVE MATERIAL, TYPE A PACKAGE, FISSILE, non-special form  
7 See SP72 - 172 0 EO See 4.1.9 See 4.1.9 See 4.1.9 See 4.1.9  
317 317 326

3328 RADIOACTIVE MATERIAL, TYPE B(U) PACKAGE, FISSILE  
7 See SP72 - 172 0 EO See 4.1.9 See 4.1.9 See 4.1.9 See 4.1.9  
317 317 326

3329 RADIOACTIVE MATERIAL, TYPE B(M) PACKAGE, FISSILE  
7 See SP72 - 172 0 EO See 4.1.9 See 4.1.9 See 4.1.9 See 4.1.9  
317 317 326

3330 RADIOACTIVE MATERIAL, TYPE C PACKAGE, FISSILE  
7 See SP72 - 172 0 EO See 4.1.9 See 4.1.9 See 4.1.9 See 4.1.9  
317 317 326

3331 RADIOACTIVE MATERIAL, TRANSPORTED UNDER SPECIAL ARRANGEMENT, FISSILE  
7 See SP72 - 172 0 EO See 4.1.9 See 4.1.9 See 4.1.9 See 4.1.9  
317 317 326

3332 RADIOACTIVE MATERIAL, TYPE A PACKAGE, SPECIAL FORM, non fissile or fissile excepted  
7 See SP72 - 172 0 EO See 4.1.9 See 4.1.9 See 4.1.9 See 4.1.9  
317 317 326

3333 RADIOACTIVE MATERIAL, TYPE A PACKAGE, SPECIAL FORM, FISSILE  
7 See SP72 - 172 0 EO See 4.1.9 See 4.1.9 See 4.1.9 See 4.1.9  
317 317 326

3334 AVIATION REGULATED LIQUID, N.O.S.  
9 - - - - - 960

UN No. (16)	Properties and Observations (17)	Stowage and Segregation (18)	Portable tanks and bulk containers		Ems (19)	F-1, S-5	TP4	T5	F-1, S-5	Category A, except for uranium, which category D applies.	See 1.5.1
			Tank instructions (15)	Provisions (14)							
(16)	(17)	(18)	4.2.5 4.3	4.2.5	5.4.5.2 7.8						

3321 Category A, except for uranium, which category D applies. See 1.5.1

3322 Category A, except for uranium, which category D applies. See 1.5.1

3323 Category A, taking account of any supplementary requirements specified in the transport documents. See 1.5.1 For ships transporting an INF cargo as defined in regulation VIII/4 of the SOLAS Convention, 1974, as amended, refer also to the INF Code.

3324 Category A, except for uranium, which category D applies, taking account of any supplementary requirements specified in the transport documents. See 1.5.1

3325 Category A, taking account of any supplementary requirements specified in the transport documents. See 1.5.1

3326 Category A, taking account of any supplementary requirements specified in the transport documents. See 1.5.1

3327 Category A, except for uranium, uranium metal pyrophoric and thorium metal pyrophoric for which category D applies, taking account of any supplementary requirements specified in the transport documents. See 1.5.1

3328 Category A, taking account of any supplementary requirements specified in the transport documents. See 1.5.1 For ships transporting an INF cargo as defined in regulation VIII/4 of the SOLAS Convention, 1974, as amended, refer also to the INF Code.

3329 Category A, taking account of any supplementary requirements specified in the transport documents. See 1.5.1 For ships transporting an INF cargo as defined in regulation VIII/4 of the SOLAS Convention, 1974, as amended, refer also to the INF Code.

3330 Category A, taking account of any supplementary requirements specified in the transport documents. See 1.5.1 For ships transporting an INF cargo as defined in regulation VIII/4 of the SOLAS Convention, 1974, as amended, refer also to the INF Code.

3331 Category A, taking account of any supplementary requirements specified in the transport documents. See 1.5.1 For ships transporting an INF cargo as defined in regulation VIII/4 of the SOLAS Convention, 1974, as amended, refer also to the INF Code.

3332 Category A. See 1.5.1

3333 Category A, taking account of any supplementary requirements specified in the transport documents. See 1.5.1

3334 Not subject to the provisions of this Code but may be subject to provisions governing the transport of dangerous goods by other modes.



UN No. (1)	PSN (2)	Class or Div (5)	Subsidiary Risk(s) (4)	Packing Group (3)	Special Provisions (6)	Limited quantities (7a)	Excepted quantities (7b)	Packing		IBC		Portable tanks and bulk containers		Stowage and Segregation (16)	Properties and Observations (17)	UN No. (18)	
								Instruc-tions (8)	Provisions (9)	Instruc-tions (10)	Provisions (11)	Tank instructions (15)	Provisions (14)				EMS (15)
3335	AVIATION REGULATED SOLID, N.O.S.	9	-	-	960	-	-	-	-	-	-	-	-	Not subject to the provisions of this Code but may be subject to provisions governing the transport of dangerous goods by other modes.	3335		
3336	MERCAPTANS, LIQUID, FLAMMABLE, N.O.S. or MERCAPTAN MIXTURE, LIQUID, FLAMMABLE, N.O.S.	3	-	I	274	0	E3	P001	-	-	-	T11	TP2	Category E. Segregation from foodstuffs as in 7.3.4.2.1, 7.6.3.1.2 or 7.7.3.6. "Separated from" odour-absorbing cargoes.	Colourless to yellow liquids with a garlic odour. Immiscible with water.	3336	
3336	MERCAPTANS, LIQUID, FLAMMABLE, N.O.S. or MERCAPTAN MIXTURE, LIQUID, FLAMMABLE, N.O.S.	3	-	II	274	1 l	E2	P001	-	IBC02	-	T7	TP1, TP2, TP8	Category B. Segregation from foodstuffs as in 7.3.4.2.1, 7.6.3.1.2 or 7.7.3.6. "Separated from" odour-absorbing cargoes.	See entry above.	3336	
3336	MERCAPTANS, LIQUID, FLAMMABLE, N.O.S. or MERCAPTAN MIXTURE, LIQUID, FLAMMABLE, N.O.S.	3	-	III	223, 274	5 l	E1	P001, P01	-	IBC03	-	T4	TP9	Category B. Segregation from foodstuffs as in 7.3.4.2.1, 7.6.3.1.2 or 7.7.3.6. "Separated from" odour-absorbing cargoes.	See entry above.	3336	
3337	REFRIGERANT GAS R 404A	2.2	-	-	-	120 ml	E1	P200	-	-	-	T50	-	Category A.	Liquefied, non-flammable, colourless gas with a faint ether-like odour. Heavier than air (1.06). Very high exposures may cause anaesthetic effects and asphyxiation.	3337	
3338	REFRIGERANT GAS R 407A	2.2	-	-	-	120 ml	E1	P200	-	-	-	T50	-	Category A.	Liquefied, non-flammable, colourless gas with a faint ether-like odour. Heavier than air (1.17). Very high exposures may cause anaesthetic effects and asphyxiation.	3338	
3339	REFRIGERANT GAS R 407B	2.2	-	-	-	120 ml	E1	P200	-	-	-	T50	-	Category A.	Liquefied, non-flammable, colourless gas with a faint ether-like odour. Heavier than air (1.19). Very high exposures may cause anaesthetic effects and asphyxiation.	3339	
3340	REFRIGERANT GAS R 407C	2.2	-	-	-	120 ml	E1	P200	-	-	-	T50	-	Category A.	Liquefied, non-flammable, colourless gas with a faint ether-like odour. Heavier than air (1.16). Very high exposures may cause anaesthetic effects and asphyxiation.	3340	
3341	THIOUREA DIOXIDE	4.2	-	II	-	0	E2	P002	PP3	IBC06	B2	T3	TP33	Category D.	White to yellow-white crystalline powder. Virtually odourless. Strong reducing agent. Violent exothermic decomposition above 100°C with emission of large amounts of sulphur oxides, ammonia, carbon monoxide, and nitrogen dioxide. Very high exposures may cause anaesthetic effects and asphyxiation. Dust (irritating to skin, eyes and mucous membranes.	3341	
3341	THIOUREA DIOXIDE	4.2	-	III	223	0	E1	P002, P02	PP3	IBC08	B3	T1	TP33	F-A, S-J	Category D.	See entry above.	3341
3342	XANTHATES	4.2	-	II	-	0	E2	P002	PP3	IBC06	B2	T3	TP33	F-A, S-J	Category D.	Hygroscopic yellow powder with an unpleasant odour. On contact with moisture, evolves highly flammable vapours such as carbon disulphide (UN 1131) which has a flashpoint of -30°C c.c. and a very low ignition temperature of 100°C. When confined, can cause an explosion due to the evolution of large amounts of carbon disulphide. Very high exposures may cause visible decomposition. Dust (irritating to skin, eyes and mucous membranes. in case carbon disulphide vapours are present.	3342
3343	NITROGLYCERIN MIXTURE, DESENSITIZED, LIQUID, FLAMMABLE, N.O.S. with not more than 30% nitroglycerin, by mass	3	-	-	274, 278	0	E0	P099	-	-	-	-	-	Category D.	-	-	3343
3344	PENTABUTYLENE TETRANITRATE, BENTENITRATO, TETRANITRAT, PENTANITRAT, DESENSITIZED, LIQUID, N.O.S. with more than 10% but not more than 20% PENT, by mass	4.1	-	II	272, 274	0	E0	P406	PP6, PP80	-	-	-	-	Category E.	-	-	3344
3345	BENZOIC ACID DERIVATIVE PESTICIDE, SOLID, TOXIC	6.1	-	I	61, 274	0	E5	P002	-	IBC07	B1	T6	TP33	F-A, S-A	Category A.	Clear of living quarters. Solid particles present a very wide range of toxic hazard. Toxic if swallowed, by skin contact or by inhalation.	3345

UN No. (1)	PSN (2)	Class (3)	Subsidiary Risk(s) (4)	Packing Group (5)	Special Provisions (6)	Limited quantities (7a)	Excepted quantities (7b)	Packing			IBC			Portable tanks and bulk containers	EMS (15)	Stowage and Segregation (16)	Properties and Observations (17)	UN No. (18)
								Class or Div (5)	Instruc-tions (8)	Provisions (9)	Instruc-tions (10)	Provisions (11)	Tank instructions (15)					
	3.1.2	2.0	2.0	2.0, 1.3	3.3	3.4	3.5	4.1, 4	4.1, 4	4.1, 4	4.1, 4	4.3	4.2, 5	7.1 to 7.7				3345
3345 PHENOXYACETIC ACID DERIVATIVE PESTICIDE, SOLID, TOXIC																		
		6.1	-	II	61 274	500 g	E4	P002	-	IBC08	B2 B4				Category A. Clear of living quarters. See entry above.			3345
3345 PHENOXYACETIC ACID DERIVATIVE PESTICIDE, SOLID, TOXIC																		
		6.1	-	III	61 223 274	5 kg	E1	P002 LP02	-	IBC08	B3				Category A. Clear of living quarters. See entry above.			3345
3345 PHENOXYACETIC ACID DERIVATIVE PESTICIDE, SOLID, TOXIC																		
		3	6.1	I	61 274	0	E0	P001	-	-	-				Category B. Clear of living quarters. Pesticides frequently containing petroleum or coal tar distillates, or other flammable liquids. Miscibility with water depends upon the composition. Toxic if swallowed, by skin contact or by inhalation.			3346
3346 PHENOXYACETIC ACID DERIVATIVE PESTICIDE, LIQUID, FLAMMABLE, TOXIC flashpoint less than 23°C																		
		3	6.1	II	61 274	1 l	E2	P001	-	IBC02	-				Category B. Clear of living quarters. See entry above.			3346
3346 PHENOXYACETIC ACID DERIVATIVE PESTICIDE, LIQUID, FLAMMABLE, TOXIC flashpoint less than 23°C																		
		6.1	3	I	61 274	0	E5	P001	-	-	-				Category B. Clear of living quarters. They frequently contain petroleum or coal tar distillates, or other flammable liquids. Flashpoint and miscibility with water depend upon the composition. Toxic if swallowed, by skin contact or by inhalation.			3347
3347 PHENOXYACETIC ACID DERIVATIVE PESTICIDE, LIQUID, TOXIC, FLAMMABLE flashpoint not less than 23°C																		
		6.1	3	II	61 274	100 ml	E4	P001	-	IBC02	-				Category B. Clear of living quarters. See entry above.			3347
3347 PHENOXYACETIC ACID DERIVATIVE PESTICIDE, LIQUID, TOXIC, FLAMMABLE flashpoint not less than 23°C																		
		6.1	3	III	61 223 274	5 l	E1	P001	-	IBC03	-				Category A. Clear of living quarters. See entry above.			3347
3347 PHENOXYACETIC ACID DERIVATIVE PESTICIDE, LIQUID, TOXIC, FLAMMABLE flashpoint not less than 23°C																		
		6.1	-	I	61 274	0	E5	P001	-	-	-				Category B. Clear of living quarters. Liquid pesticides which present a very wide range of toxic hazard. Miscibility with water depends upon the composition. Toxic if swallowed, by skin contact or by inhalation.			3348
3348 PHENOXYACETIC ACID DERIVATIVE PESTICIDE, LIQUID, TOXIC																		
		6.1	-	II	61 274	100 ml	E4	P001	-	IBC02	-				Category B. Clear of living quarters. See entry above.			3348
3348 PHENOXYACETIC ACID DERIVATIVE PESTICIDE, LIQUID, TOXIC																		
		6.1	-	III	61 223 274	5 l	E1	P001 LP01	-	IBC03	-				Category A. Clear of living quarters. See entry above.			3348
3348 PHENOXYACETIC ACID DERIVATIVE PESTICIDE, LIQUID, TOXIC																		
		6.1	-	I	61 274	0	E5	P002	-	IBC07	B1				Category A. Clear of living quarters. Solid pesticides present a very wide range of toxic hazard. Toxic if swallowed, by skin contact or by inhalation.			3349
3349 PYRETHROID PESTICIDE, SOLID, TOXIC																		
		6.1	-	II	61 274	500 g	E4	P002	-	IBC08	B2 B4				Category A. Clear of living quarters. See entry above.			3349
3349 PYRETHROID PESTICIDE, SOLID, TOXIC																		
		6.1	-	III	61 223 274	5 kg	E1	P002 LP02	-	IBC08	B3				Category A. Clear of living quarters. See entry above.			3349
3349 PYRETHROID PESTICIDE, SOLID, TOXIC																		
		3	6.1	I	61 274	0	E0	P001	-	-	-				Category B. Clear of living quarters. Miscibility with water depends upon the composition. Toxic if swallowed, by skin contact or by inhalation.			3350
3350 PYRETHROID PESTICIDE, LIQUID, FLAMMABLE, TOXIC, flashpoint less than 23°C																		

UN No. (1)	PSN (2)	Class or Div. (5)	Subsidiary Risk(s) (4)	Packing Group (3)	Special Provisions (6)	Limited quantities (7a)	Excepted quantities (7b)	Packing			IBC		
								Class or Div. (5)	Instruc-tions (8)	Provisions (9)	Instruc-tions (10)	Provisions (11)	
	3.1.2	2.0	2.0	2.0	1.3	3.3	3.4	3.5	4.1, 4	4.1, 4	4.1, 4	4.1, 4	

Portable tanks and bulk containers		
Tank instructions (15)	Provisions (14)	EMs (16)
4.2.5 4.3	4.2.5	5.4.3.2 7.8

UN No. (18)	Properties and Observations (17)

3350	PYRETHROID PESTICIDE, LIQUID, FLAMMABLE, TOXIC; flashpoint less than 23 °C	3	6.1	II		61 274	1 ℓ	E2	P001	-	IBC02	-	T11	TP2 TP3 TP27	F-E, S-D	Category B. Clear of living quarters. See entry above.	3350
3351	PYRETHROID PESTICIDE, LIQUID, TOXIC, FLAMMABLE; flashpoint not less than 23°C	6.1	3	I		61 274	0	E5	P001	-	-	-	T14	TP2 TP3 TP27	F-E, S-D	Category B. Clear of living quarters. They frequently contain petroleum or coal tar distillates, or other flammable liquids. Flashpoint and miscibility with water depend upon the composition. Toxic if swallowed, by skin contact or by inhalation.	3351
3351	PYRETHROID PESTICIDE, LIQUID, TOXIC, FLAMMABLE; flashpoint not less than 23°C	6.1	3	II		61 274	100 ml	E4	P001	-	IBC02	-	T11	TP2 TP3 TP27	F-E, S-D	Category B. Clear of living quarters. See entry above.	3351
3351	PYRETHROID PESTICIDE, LIQUID, TOXIC, FLAMMABLE; flashpoint not less than 23°C	6.1	3	III		61 274	5 ℓ	E1	P001	-	IBC03	-	T7	TP2 TP28	F-E, S-D	Category A. Clear of living quarters. See entry above.	3351
3352	PYRETHROID PESTICIDE, LIQUID, TOXIC	6.1	-	I		61 274	0	E5	P001	-	-	-	T14	TP2 TP3 TP27	F-A, S-A	Category B. Clear of living quarters. Liquid pesticides which present a very wide range of toxic hazards depending upon the composition. Toxic if swallowed, by skin contact or by inhalation.	3352
3352	PYRETHROID PESTICIDE, LIQUID, TOXIC	6.1	-	II		61 274	100 ml	E4	P001	-	IBC02	-	T11	TP2 TP27	F-A, S-A	Category B. Clear of living quarters. See entry above.	3352
3352	PYRETHROID PESTICIDE, LIQUID, TOXIC	6.1	-	III		61 273 274	5 ℓ	E1	P001 LP01	-	IBC03	-	T7	TP2 TP28	F-A, S-A	Category A. Clear of living quarters. See entry above.	3352
3354	INSECTICIDE GAS, FLAMMABLE, N.O.S.	2.1	-	-		274	0	E0	P200	-	-	-	-	-	F-D, S-U	Category D. Flammable mixtures of insecticides with liquefied gases.	3354
3355	INSECTICIDE GAS, TOXIC, FLAMMABLE, N.O.S.	2.3	2.1	-		274	0	E0	P200	-	-	-	-	-	F-D, S-U	Category D. Clear of living quarters. Toxic, flammable mixtures of insecticides with liquefied gases.	3355
3356	OXYGEN GENERATOR, CHEMICAL	5.1	-	II		284	0	E0	P500	-	-	-	-	-	F-H, S-Q	Category D. Oxygen generators, chemicals, are devices containing chemicals which upon activation release oxygen as a product of chemical reaction. Chemical oxygen generators are used for the generation of oxygen for breathing apparatus. Oxidizing salts such as chlorates and perchlorates of lithium, sodium and potassium, which are used in chemical oxygen generators, evolve oxygen when heated. These salts are mixed compounded with a fuel, usually iron powder, to form a carbide which is used to generate heat by oxidation. Once the reaction begins, oxygen is released from the hot salt by thermal decomposition (a thermal shield is used around the generator). A portion of the oxygen reacts with the fuel to form iron oxide which provides energy for the reaction. The activation of the reaction can be achieved by a percussion device, friction device or electric wire.	3356
3357	NITROGLYCERIN MIXTURE, DISSENSITIZED, LIQUID, N.O.S. with not more than 30% nitroglycerin, by mass	3	-	II		274 288	0	E0	P099	-	-	-	-	-	F-E, S-Y	Category D.	3357
3358	REFRIGERATING MACHINES containing flammable, non-toxic, liquefied gas	2.1	-	-		291	0	E0	P003	PP3.2	-	-	-	-	F-D, S-U	Category D.	3358
3359	FUMIGATED CARGO TRANSPORT UNIT	9	-	-		302	0	E0	-	-	-	-	-	-	F-A, S-D	Category B. Clear of living quarters. A FUMIGATED CARGO TRANSPORT UNIT is a closed cargo transport unit containing goods or materials that either are or have been fumigated within the unit. The fumigant gases used are either poisonous or asphyxiant. The gases are usually evolved from solid or liquid preparations distributed within the unit. See para 3.3.2.	3359

UN No. (1)	PSN (2)	Class No. (3)	Subsidiary Risk(s) (4)	Packing Group (5)	Special Provisions (6)	Limited quantities (7a)	Excepted quantities (7b)	Packing		IBC	
								Institutions (8)	Provisions (9)	Institutions (10)	Provisions (11)
3362	3.1.2	2.0	2.0	2.0, 1.3	3.3	3.4	3.5	4.1, 4	4.1, 4	4.1, 4	4.1, 4

3360 FIBRES, VEGETABLE, DRY  
4.1 - - - 29, 117, 259  
0 ED P003 PPI9 - - -

3361 CHLOROSILANES, TOXIC, CORROSIVE, N.O.S.  
6.1 8 II 274 0 ED P010 - - -  
Colourless to yellow liquids with a pungent odour. Immiscible with water. Reacts violently with water or steam, evolving hydrogen chloride, an extremely toxic gas. In the presence of moisture, highly corrosive to most metals. Toxic if swallowed, by skin contact or by inhalation. Cause burns to skin, eyes and mucous membranes.

3362 CHLOROSILANES, TOXIC, CORROSIVE, FLAMMABLE, N.O.S.  
6.1 3/8 II 274 0 ED P010 - - -  
Colourless to yellow flammable liquids with a pungent odour. Immiscible with water. Reacts violently with water or steam, evolving hydrogen chloride, an irritating and corrosive gas, as well as white fumes. When involved in a fire, evolve toxic gas. In the presence of moisture, highly corrosive to most metals. Toxic if swallowed, by skin contact or by inhalation. Cause burns to skin, eyes and mucous membranes.

3363 DANGEROUS GOODS IN MACHINERY or DANGEROUS GOODS IN APPARATUS  
9 - - 301 See SP.201 ED P907 - - -  
Types of articles transported under this entry contain only limited quantities of dangerous goods.

3364 TRINITROPHENOL (PICRIC ACID), WETTED with not less than 10% water, by mass  
4.1 - I 28 0 ED P406 P24 P31  
Desensitized explosive. Substance in pure form consists of yellow crystals. Soluble in water. Explosive and sensitive to friction in the dry state. May form extremely sensitive compounds with heavy metals or their salts. Harmful if swallowed or by skin contact.

3365 TRINITROCHLOROBENZENE (PICRYL CHLORIDE), WETTED with not less than 10% water, by mass  
4.1 - I 28 0 ED P406 P24 P31  
Desensitized explosive. Explosive and sensitive to shock and heat in the dry state. Reacts violently with heavy metals and their salts.

3366 TRINITROTOLUENE (TNT), WETTED with not less than 10% water, by mass  
4.1 - I 28 0 ED P406 P24 P31  
Desensitized explosive. Substance in pure form consists of yellow crystals. When involved in a fire, evolves toxic fumes. In closed compartments, these fumes may form an explosive mixture with air. Explosive and sensitive to shock and heat in the dry state. Harmful if swallowed or by skin contact. Reacts violently with heavy metals and their salts.

3367 TRINITROBENZENE, WETTED with not less than 10% water, by mass  
4.1 - I 28 0 ED P406 P24 P31  
Desensitized explosive. Substance in pure form consists of odorless yellow crystals. When involved in a fire, evolves toxic fumes. In closed compartments, these fumes may form an explosive mixture with air. Explosive and sensitive to shock and heat in the dry state. Harmful if swallowed or by skin contact. Reacts violently with heavy metals and their salts.

3368 TRINITROBENZOIC ACID, WETTED with not less than 10% water, by mass  
4.1 - I 28 0 ED P406 P24 P31  
Desensitized explosive. Substance in pure form consists of yellow crystals. When involved in a fire, evolves toxic fumes. In closed compartments, these fumes may form an explosive mixture with air. Explosive and sensitive to shock and heat in the dry state. Harmful if swallowed or by skin contact. Reacts violently with heavy metals and their salts.

3369 SODIUM DINITRO-*o*-CRSOLATE, WETTED with not less than 10% water, by mass  
4.1 P 6.1 I 28 0 ED P406 P24 P31  
Desensitized explosive. Substance in pure form consists of yellow powder. May form extremely sensitive compounds with heavy metals or their salts. When involved in a fire, evolves toxic fumes. In closed compartments, these fumes may form an explosive mixture with air. Explosive and sensitive to friction in the dry state. Toxic if swallowed, by skin contact or by inhalation.

3370 UREA NITRATE, WETTED with not less than 10% water, by mass  
4.1 - I 28 0 ED P406 P31 P78  
Desensitized explosive. May form extremely sensitive compounds, with heavy metals or their salts. Explosive and sensitive to friction in the dry state. Harmful if swallowed or by skin contact.

3371 2-METHYLBUTANAL  
3 - - II - - 1 P E2 P001 - IBC02 - -  
Colourless liquid. Flashpoint: -3.5°C. Explosive limits: 1.3 to 13.9%. Slightly miscible with water.

3373 BIOLOGICAL SUBSTANCE, CATEGORY B  
6.2 - - 319, 341 0 ED P650 - -  
Substances which are known or are reasonably expected to contain pathogens, transported in a form that when exposure to it occurs, are not capable of causing permanent disability, life-threatening or fatal disease to humans or animals. Human or animal specimens for which there is potential for infectious disease. Pathogens, as defined in the provisions of this Code (see 2.6.3.2.3, 2.6). Other exemptions are stated in 2.6.3.2.3.

UN No. (1)	PSN (2)	Class No. (3)	Subsidiary Risk(s) (4)	Packing Group (5)	Special Provisions (6)	Limited quantities (7a)	Excepted quantities (7b)	Packing		IBC		Properties and Observations (17)
								Institutions (8)	Provisions (9)	Institutions (10)	Provisions (11)	
3360												

3360 FIBRES, VEGETABLE, DRY  
4.1 - - - F-A, S-1 Category A.  
Ignite readily. Consignments of cotton, dry having a density not less than 1.5 kg/m<sup>3</sup> and of other natural fibres, dry having a density not less than 360 kg/m<sup>3</sup> (ISO Standard 8115 (1986)) and tamping fibre, dry having a density not less than 360 kg/m<sup>3</sup> are not subject to the provisions of this Code when carried in closed cargo transport units.

3361 CHLOROSILANES, TOXIC, CORROSIVE, N.O.S.  
6.1 8 II 274 0 ED P010 - - -  
Colourless to yellow liquids with a pungent odour. Immiscible with water. Reacts violently with water or steam, evolving hydrogen chloride, an extremely toxic gas. In the presence of moisture, highly corrosive to most metals. Toxic if swallowed, by skin contact or by inhalation. Cause burns to skin, eyes and mucous membranes.

3362 CHLOROSILANES, TOXIC, CORROSIVE, FLAMMABLE, N.O.S.  
6.1 3/8 II 274 0 ED P010 - - -  
Colourless to yellow flammable liquids with a pungent odour. Immiscible with water. Reacts violently with water or steam, evolving hydrogen chloride, an irritating and corrosive gas, as well as white fumes. When involved in a fire, evolve toxic gas. In the presence of moisture, highly corrosive to most metals. Toxic if swallowed, by skin contact or by inhalation. Cause burns to skin, eyes and mucous membranes.

3363 DANGEROUS GOODS IN MACHINERY or DANGEROUS GOODS IN APPARATUS  
9 - - 301 See SP.201 ED P907 - - -  
Types of articles transported under this entry contain only limited quantities of dangerous goods.

3364 TRINITROPHENOL (PICRIC ACID), WETTED with not less than 10% water, by mass  
4.1 - I 28 0 ED P406 P24 P31  
Desensitized explosive. Substance in pure form consists of yellow crystals. Soluble in water. Explosive and sensitive to friction in the dry state. May form extremely sensitive compounds with heavy metals or their salts. Harmful if swallowed or by skin contact.

3365 TRINITROCHLOROBENZENE (PICRYL CHLORIDE), WETTED with not less than 10% water, by mass  
4.1 - I 28 0 ED P406 P24 P31  
Desensitized explosive. Explosive and sensitive to shock and heat in the dry state. Reacts violently with heavy metals and their salts.

3366 TRINITROTOLUENE (TNT), WETTED with not less than 10% water, by mass  
4.1 - I 28 0 ED P406 P24 P31  
Desensitized explosive. Substance in pure form consists of yellow crystals. When involved in a fire, evolves toxic fumes. In closed compartments, these fumes may form an explosive mixture with air. Explosive and sensitive to shock and heat in the dry state. Harmful if swallowed or by skin contact. Reacts violently with heavy metals and their salts.

3367 TRINITROBENZENE, WETTED with not less than 10% water, by mass  
4.1 - I 28 0 ED P406 P24 P31  
Desensitized explosive. Substance in pure form consists of odorless yellow crystals. When involved in a fire, evolves toxic fumes. In closed compartments, these fumes may form an explosive mixture with air. Explosive and sensitive to shock and heat in the dry state. Harmful if swallowed or by skin contact. Reacts violently with heavy metals and their salts.

3368 TRINITROBENZOIC ACID, WETTED with not less than 10% water, by mass  
4.1 - I 28 0 ED P406 P24 P31  
Desensitized explosive. Substance in pure form consists of yellow crystals. When involved in a fire, evolves toxic fumes. In closed compartments, these fumes may form an explosive mixture with air. Explosive and sensitive to shock and heat in the dry state. Harmful if swallowed or by skin contact. Reacts violently with heavy metals and their salts.

3369 SODIUM DINITRO-*o*-CRSOLATE, WETTED with not less than 10% water, by mass  
4.1 P 6.1 I 28 0 ED P406 P24 P31  
Desensitized explosive. Substance in pure form consists of yellow powder. May form extremely sensitive compounds with heavy metals or their salts. When involved in a fire, evolves toxic fumes. In closed compartments, these fumes may form an explosive mixture with air. Explosive and sensitive to friction in the dry state. Toxic if swallowed, by skin contact or by inhalation.

3370 UREA NITRATE, WETTED with not less than 10% water, by mass  
4.1 - I 28 0 ED P406 P31 P78  
Desensitized explosive. May form extremely sensitive compounds, with heavy metals or their salts. Explosive and sensitive to friction in the dry state. Harmful if swallowed or by skin contact.

3371 2-METHYLBUTANAL  
3 - - II - - 1 P E2 P001 - IBC02 - -  
Colourless liquid. Flashpoint: -3.5°C. Explosive limits: 1.3 to 13.9%. Slightly miscible with water.

3373 BIOLOGICAL SUBSTANCE, CATEGORY B  
6.2 - - 319, 341 0 ED P650 - -  
Substances which are known or are reasonably expected to contain pathogens, transported in a form that when exposure to it occurs, are not capable of causing permanent disability, life-threatening or fatal disease to humans or animals. Human or animal specimens for which there is potential for infectious disease. Pathogens, as defined in the provisions of this Code (see 2.6.3.2.3, 2.6). Other exemptions are stated in 2.6.3.2.3.

UN No. (1)	PSN (2)	Class No. (3)	Subsidiary Risk(s) (4)	Packing Group (5)	Special Provisions (6)	Limited quantities (7a)	Excepted quantities (7b)	Packing			IBC			Tank instructions (15)	Ems (15)	Stowage and Segregation (16)	Properties and Observations (17)	UN No. (18)
								Instruc-tions (8)	Provisions (9)	Institu-tions (10)	Instruc-tions (11)	Provisions (12)	Institu-tions (13)					
3374	ACETYLENE, SOLVENT FREE	2.1	-	-	-	0	EO	P200	-	-	-	-	-	-	-	-	-	3374
3375	AMMONIUM NITRATE EMULSION or SUSPENSION or GEL intermediate for blasting explosives	5.1	-	II	309	0	E2	P099	-	IBC99	-	-	-	-	-	-	-	3375
3376	4-NITROPHENYLDIAZINE, with not less than 30% water, by mass	4.1	-	I	28	0	EO	P406	PP26	PP51	-	-	-	-	-	-	-	3376
3377	SODIUM PEROBATE MONOHYDRATE	5.1	-	III	967	5 kg	E1	P002	LP02	IBC08	B3	-	-	-	-	-	-	3377
3378	SODIUM CARBONATE PEROXYHYDRATE	5.1	-	II	-	1 kg	E2	P002	-	IBC08	B2	B4	-	-	-	-	-	3378
3378	SODIUM CARBONATE PEROXYHYDRATE	5.1	-	III	-	5 kg	E1	P002	LP02	IBC08	B3	-	-	-	-	-	-	3378
3379	DESENSITIZED EXPLOSIVE, LIQUID, N.O.S.	3	-	I	274	0	EO	P099	-	-	-	-	-	-	-	-	-	3379
3380	DESENSITIZED EXPLOSIVE, SOLID, N.O.S.	4.1	-	I	274	0	EO	P099	-	-	-	-	-	-	-	-	-	3380
3381	TOXIC BY INHALATION LIQUID, N.O.S. with an LC50 lower than or equal to 200 ml/m <sup>3</sup> and saturated vapour concentration greater than or equal to 500 LC50	6.1	-	I	274	0	EO	P601	-	-	-	-	-	-	-	-	-	3381
3382	TOXIC BY INHALATION LIQUID, N.O.S. with an LC50 lower than or equal to 1000 ml/m <sup>3</sup> and saturated vapour concentration greater than or equal to 10 LC50	6.1	-	I	274	0	EO	P602	-	-	-	-	-	-	-	-	-	3382
3383	TOXIC BY INHALATION LIQUID, FLAMMABLE, N.O.S. with an LC50 lower than or equal to 200 ml/m <sup>3</sup> and saturated vapour concentration greater than or equal to 500 LC50	6.1	3	I	274	0	EO	P601	-	-	-	-	-	-	-	-	-	3383
3384	TOXIC BY INHALATION LIQUID, FLAMMABLE, N.O.S. with an LC50 lower than or equal to 1000 ml/m <sup>3</sup> and saturated vapour concentration greater than or equal to 10 LC50	6.1	3	I	274	0	EO	P602	-	-	-	-	-	-	-	-	-	3384
3385	TOXIC BY INHALATION LIQUID, WATER REACTIVE, N.O.S. with an LC50 lower than or equal to 200 ml/m <sup>3</sup> and saturated vapour concentration greater than or equal to 500 LC50	6.1	4.3	I	274	0	EO	P601	-	-	-	-	-	-	-	-	-	3385

Portable tanks and bulk containers	UN No. (18)	Properties and Observations (17)	Stowage and Segregation (16)	Ems (15)	Category	Explanatory text
Tank instructions (15) 4.2.5 4.3	(14) 4.2.5 7.8	(17)	7.1 to 7.7	(15) 54.5.2 7.8	F, D, S, U	Category D. Protected from sources of heat, fire and flame. Separated from chlorides.
TP9 TP92	(19) 7.8	(17)	7.1 to 7.7	(15) 54.5.2 7.8	F, D, S, U	Category D. Protected from sources of heat, fire and flame. Separated from chlorides.
TP9 TP92	(19) 7.8	(17)	7.1 to 7.7	(15) 54.5.2 7.8	F, H, S, Q	Category D. Protected from sources of heat, fire and flame. Separated from Class 4.1 liquids, bromates, chlorates, chlorites, hypochlorites, nitrites, perchlorates, permanganate and powdered metals.
TP3 BK2, BK3	(19) 7.8	(17)	7.1 to 7.7	(15) 54.5.2 7.8	F, A, S, Q	Category A. Keep as dry as reasonably practicable. Separated from sources of heat. When transported in BK3 bulk container, see 7.6.2.12 and 7.7.3.9.
TP3 BK2	(19) 7.8	(17)	7.1 to 7.7	(15) 54.5.2 7.8	F, A, S, Q	Category A. Keep as dry as reasonably practicable. Separated from sources of heat. When transported in BK3 bulk container, see 7.6.2.12 and 7.7.3.9.
TP3 BK2, BK3	(19) 7.8	(17)	7.1 to 7.7	(15) 54.5.2 7.8	F, A, S, Q	Category A. Keep as dry as reasonably practicable. Separated from sources of heat. When transported in BK3 bulk container, see 7.6.2.12 and 7.7.3.9.
TP3 BK2, BK3	(19) 7.8	(17)	7.1 to 7.7	(15) 54.5.2 7.8	F, A, S, Q	Category A. Keep as dry as reasonably practicable. Separated from sources of heat. When transported in BK3 bulk container, see 7.6.2.12 and 7.7.3.9.
TP2 TP13	(19) 7.8	(17)	7.1 to 7.7	(15) 54.5.2 7.8	F, E, S, Y	Category D. "Away from" heavy metals and their salts.
TP2 TP13	(19) 7.8	(17)	7.1 to 7.7	(15) 54.5.2 7.8	F, E, S, J	Category D. "Away from" Class 3 and heavy metals and their salts.
TP2 TP13	(19) 7.8	(17)	7.1 to 7.7	(15) 54.5.2 7.8	F, E, S, A	Category D. Clear of living quarters.
TP2 TP13	(19) 7.8	(17)	7.1 to 7.7	(15) 54.5.2 7.8	F, A, S, A	Category D. Clear of living quarters.
TP2 TP13	(19) 7.8	(17)	7.1 to 7.7	(15) 54.5.2 7.8	F, E, S, D	Category D. Clear of living quarters.
TP2 TP13	(19) 7.8	(17)	7.1 to 7.7	(15) 54.5.2 7.8	F, E, S, D	Category D. Clear of living quarters.
TP2 TP13	(19) 7.8	(17)	7.1 to 7.7	(15) 54.5.2 7.8	F, C, S, N	Category D. Clear of living quarters.

UN No. (1)	PSN (2)	Class No. (3)	Subsidiary Risk(s) (4)	Packing Group (5)	Special Provisions (6)	Limited quantities (7a)	Excepted quantities (7b)	Instruc-tions (8)	Provisions (9)	Institu-tions (10)	Instruc-tions (11)	Provisions (12)	Institu-tions (13)	Provisions (14)	UN No. (18)
3374	ACETYLENE, SOLVENT FREE	2.1	-	-	-	0	EO	P200	-	-	-	-	-	-	3374
3375	AMMONIUM NITRATE EMULSION or SUSPENSION or GEL intermediate for blasting explosives	5.1	-	II	309	0	E2	P099	-	IBC99	-	-	-	-	3375
3376	4-NITROPHENYLDIAZINE, with not less than 30% water, by mass	4.1	-	I	28	0	EO	P406	PP26	PP51	-	-	-	-	3376
3377	SODIUM PEROBATE MONOHYDRATE	5.1	-	III	967	5 kg	E1	P002	LP02	IBC08	B3	-	-	-	3377
3378	SODIUM CARBONATE PEROXYHYDRATE	5.1	-	II	-	1 kg	E2	P002	-	IBC08	B2	B4	-	-	3378
3378	SODIUM CARBONATE PEROXYHYDRATE	5.1	-	III	-	5 kg	E1	P002	LP02	IBC08	B3	-	-	-	3378
3379	DESENSITIZED EXPLOSIVE, LIQUID, N.O.S.	3	-	I	274	0	EO	P099	-	-	-	-	-	-	3379
3380	DESENSITIZED EXPLOSIVE, SOLID, N.O.S.	4.1	-	I	274	0	EO	P099	-	-	-	-	-	-	3380
3381	TOXIC BY INHALATION LIQUID, N.O.S. with an LC50 lower than or equal to 200 ml/m <sup>3</sup> and saturated vapour concentration greater than or equal to 500 LC50	6.1	-	I	274	0	EO	P601	-	-	-	-	-	-	3381
3382	TOXIC BY INHALATION LIQUID, N.O.S. with an LC50 lower than or equal to 1000 ml/m <sup>3</sup> and saturated vapour concentration greater than or equal to 10 LC50	6.1	-	I	274	0	EO	P602	-	-	-	-	-	-	3382
3383	TOXIC BY INHALATION LIQUID, FLAMMABLE, N.O.S. with an LC50 lower than or equal to 200 ml/m <sup>3</sup> and saturated vapour concentration greater than or equal to 500 LC50	6.1	3	I	274	0	EO	P601	-	-	-	-	-	-	3383
3384	TOXIC BY INHALATION LIQUID, FLAMMABLE, N.O.S. with an LC50 lower than or equal to 1000 ml/m <sup>3</sup> and saturated vapour concentration greater than or equal to 10 LC50	6.1	3	I	274	0	EO	P602	-	-	-	-	-	-	3384
3385	TOXIC BY INHALATION LIQUID, WATER REACTIVE, N.O.S. with an LC50 lower than or equal to 200 ml/m <sup>3</sup> and saturated vapour concentration greater than or equal to 500 LC50	6.1	4.3	I	274	0	EO	P601	-	-	-	-	-	-	3385

**TSFS 2015:66**  
**Bilaga 1**

UN No. (1)	PSN (2)	Class No. (3)	Subsidiary Risk(s) (4)	Packing Group (5)	Special Provisions (6)	Limited quantities (7a)	Excepted quantities (7b)	Packing		IBC	
								Institutions (8)	Provisions (9)	Institutions (10)	Provisions (11)
312	3.1.2	2.0	2.0	2.0, 1.3	3.3	3.4	3.5	4.1, 4	4.1, 4	4.1, 4	4.1, 4

Tank instructions (15)	Provisions (14)	EMs (15)	Stowage and Segregation (16)	Properties and Observations (17)	UN No. (18)
4.2.5 4.3	4.2.5	5.4, 5.2 7.8	7.1 to 7.7		

3386	TOXIC BY INHALATION LIQUID, WATER-REACTIVE, N.O.S. with saturated vapour concentration greater than or equal to 10 LC <sub>50</sub>	6.1	4.3	I	274	0	EO	P602	-	-	-	T20 TP13	F-C, S-N	Category D. Clear of living quarters. A variety of toxic liquids which present a highly toxic inhalation hazard as well as being oxidizer, highly toxic if swallowed, by skin contact or by inhalation.	3386
3387	TOXIC BY INHALATION LIQUID, OXIDIZING, N.O.S. with an LC <sub>50</sub> lower than or equal to 200 ml/m <sup>3</sup> and saturated vapour concentration greater than or equal to 500 LC <sub>50</sub>	6.1	5.1	I	274	0	EO	P601	-	-	-	T22 TP13	F-A, S-Q	Category D. Clear of living quarters. A variety of toxic liquids which present a highly toxic inhalation hazard as well as being oxidizer, highly toxic if swallowed, by skin contact or by inhalation.	3387
3388	TOXIC BY INHALATION LIQUID, OXIDIZING, N.O.S. with an LC <sub>50</sub> lower than or equal to 1000 ml/m <sup>3</sup> and saturated vapour concentration greater than or equal to 10 LC <sub>50</sub>	6.1	5.1	I	274	0	EO	P602	-	-	-	T20 TP13	F-A, S-Q	Category D. Clear of living quarters. A variety of toxic liquids which present a highly toxic inhalation hazard as well as being oxidizer, highly toxic if swallowed, by skin contact or by inhalation.	3388
3389	TOXIC BY INHALATION LIQUID, CORROSIVE, N.O.S. with an LC <sub>50</sub> lower than or equal to 200 ml/m <sup>3</sup> and saturated vapour concentration greater than or equal to 500 LC <sub>50</sub>	6.1	8	I	274	0	EO	P601	-	-	-	T22 TP13	F-A, S-B	Category D. Clear of living quarters. A variety of toxic liquids which present a highly toxic inhalation hazard as well as corrosive, highly toxic if swallowed, by skin contact or by inhalation.	3389
3390	TOXIC BY INHALATION LIQUID, CORROSIVE, N.O.S. with an LC <sub>50</sub> lower than or equal to 1000 ml/m <sup>3</sup> and saturated vapour concentration greater than or equal to 10 LC <sub>50</sub>	6.1	8	I	274	0	EO	P602	-	-	-	T20 TP13	F-A, S-B	Category D. Clear of living quarters. A variety of toxic liquids which present a highly toxic inhalation hazard as well as corrosive, highly toxic if swallowed, by skin contact or by inhalation.	3390
3391	ORGANOMETALLIC SUBSTANCE, SOLID, PYROPHORIC	4.2	-	I	274	0	EO	P404	PP86	-	-	T21 TP7 TP3 TP36	F-G, S-M	Category D. Liable to ignite spontaneously in air, if shaken, may produce sparks.	3391
3392	ORGANOMETALLIC SUBSTANCE, LIQUID, PYROPHORIC	4.2	-	I	274	0	EO	P400	PP86	-	-	T21 TP7 TP36	F-G, S-M	Category D. Separated longitudinally by an intervening complete compartment or hold from "Class 1".	3392
3393	ORGANOMETALLIC SUBSTANCE, SOLID, PYROPHORIC, WATER-REACTIVE	4.2	4.3	I	274	0	EO	P404	PP86	-	-	T21 TP7 TP3 TP36	F-G, S-M	Category D. "Separated from" acids. Liable to ignite spontaneously in air, if shaken, may produce sparks. React violently with moisture, water and acids evolving flammable gas.	3393
3394	ORGANOMETALLIC SUBSTANCE, LIQUID, PYROPHORIC, WATER-REACTIVE	4.2	4.3	I	274	0	EO	P400	PP86	-	-	T21 TP7 TP36	F-G, S-M	Category D. "Separated from" acids. Liable to ignite spontaneously in air, if shaken, may produce sparks. React violently with moisture, water and acids evolving flammable gas.	3394
3395	ORGANOMETALLIC SUBSTANCE, SOLID, WATER-REACTIVE	4.3	-	I	274	0	EO	P403	-	-	-	T9 TP3 TP36	F-G, S-N	Category E. Clear of living quarters. Reacts violently with moisture, water and acids evolving flammable gas.	3395
3395	ORGANOMETALLIC SUBSTANCE, SOLID, WATER-REACTIVE	4.3	-	II	274	500 g	E2	P410	-	IBC04	-	TP3 TP36	F-G, S-N	Category E. Clear of living quarters. See entry above.	3395
3395	ORGANOMETALLIC SUBSTANCE, SOLID, WATER-REACTIVE	4.3	-	III	274 274	1 kg	E1	P410	-	IBC06	-	TP3 TP36	F-G, S-N	Category E. Clear of living quarters. See entry above.	3395
3396	ORGANOMETALLIC SUBSTANCE, SOLID, WATER-REACTIVE, FLAMMABLE	4.3	4.1	I	274	0	EO	P403	-	-	-	TP7 TP3 TP36	F-G, S-N	Category E. Clear of living quarters. Flammable solid. Reacts violently with moisture, water and acids evolving flammable gas.	3396
3396	ORGANOMETALLIC SUBSTANCE, SOLID, WATER-REACTIVE, FLAMMABLE	4.3	4.1	II	274	500 g	E2	P410	-	IBC04	-	TP3 TP36	F-G, S-N	Category E. Clear of living quarters. See entry above.	3396

UN No. (1)	PSN (2)	Class (3)	Subsidiary Risk(s) (4)	Packing Group (5)	Special Provisions (6)	Limited quantities (7a)	Excepted quantities (7b)	Packing			IBC		Properties and Observations (17)	UN No. (18)
								Instruc-tions (8)	Provisions (9)	Instruc-tions (10)	Provisions (11)	Tank instructions (15)		
3396	ORGANOMETALLIC SUBSTANCE, SOLID, WATER-REACTIVE, FLAMMABLE	4.3	4.1	III	223 274	1 kg	E1	P410	-	IBC06	-	Category E. Clear of living quarters. See entry above. Separated from acids.	3396	
3397	ORGANOMETALLIC SUBSTANCE, SOLID, WATER-REACTIVE, SELF-HEATING	4.3	4.2	I	274	0	E0	P403	-	-	-	Category E. Clear of living quarters. Liable to self-heating or spontaneous combustion. Reacts violently with moisture, water and acids evolving flammable gas.	3397	
3397	ORGANOMETALLIC SUBSTANCE, SOLID, WATER-REACTIVE, SELF-HEATING	4.3	4.2	II	274	500 g	E2	P410	-	IBC04	-	Category E. Clear of living quarters. See entry above. Separated from acids.	3397	
3397	ORGANOMETALLIC SUBSTANCE, SOLID, WATER-REACTIVE, SELF-HEATING	4.3	4.2	III	223 274	1 kg	E1	P410	-	IBC06	-	Category E. Clear of living quarters. See entry above. Separated from acids.	3397	
3398	ORGANOMETALLIC SUBSTANCE, LIQUID, WATER-REACTIVE	4.3	-	I	274	0	E0	P402	PP31	-	-	Category E. Clear of living quarters. Reacts violently with moisture, water and acids evolving flammable gas. Separated from acids.	3398	
3398	ORGANOMETALLIC SUBSTANCE, LIQUID, WATER-REACTIVE	4.3	-	II	274	500 ml	E2	P001	PP31	IBC01	-	Category E. Clear of living quarters. See entry above. Separated from acids.	3398	
3398	ORGANOMETALLIC SUBSTANCE, LIQUID, WATER-REACTIVE	4.3	-	III	223 274	1 l	E1	P001	PP31	IBC02	-	Category E. Clear of living quarters. See entry above. Separated from acids.	3398	
3399	ORGANOMETALLIC SUBSTANCE, LIQUID, WATER-REACTIVE, FLAMMABLE	4.3	3	I	274	0	E0	P402	PP31	-	-	Category D. Clear of living quarters. Flammable liquid. Reacts violently with moisture, water and acids evolving flammable gas. Separated from acids.	3399	
3399	ORGANOMETALLIC SUBSTANCE, LIQUID, WATER-REACTIVE, FLAMMABLE	4.3	3	II	274	500 ml	E2	P001	PP31	IBC01	-	Category D. Clear of living quarters. See entry above. Separated from acids.	3399	
3399	ORGANOMETALLIC SUBSTANCE, LIQUID, WATER-REACTIVE, FLAMMABLE	4.3	3	III	223 274	1 l	E1	P001	PP31	IBC02	-	Category E. Clear of living quarters. See entry above. Separated from acids.	3399	
3400	ORGANOMETALLIC SUBSTANCE, SOLID, SELF-HEATING	4.2	-	II	274	500 g	E2	P410	-	IBC06	-	Liable to self-heating or spontaneous combustion.	3400	
3400	ORGANOMETALLIC SUBSTANCE, SOLID, SELF-HEATING	4.2	-	III	223 274	1 kg	E1	P002	-	IBC08	-	See entry above.	3400	
3401	ALUMINUM METAL AMALGAM, SOLID	4.3	-	I	182	0	E0	P403	PP31	-	-	Category D. Separated from acids. Silvery solid, consisting of metal alloyed with mercury. Reacts with moisture, water or acids, evolving hydrogen, a flammable gas. When heated, evolves toxic vapours.	3401	
3402	ALKALINE EARTH METAL AMALGAM, SOLID	4.3	-	I	183	0	E0	P403	PP31	-	-	Category D. Separated from acids. Consists of metal alloyed with mercury. Contains 2% to 10% alkaline earth metals and may contain up to 98% mercury. Reacts with moisture, water or acids, evolving hydrogen, a flammable gas. When heated, evolves toxic vapours.	3402	

UN No. (1)	PSN (2)	Class or Div (3)	Subsidiary Risk(s) (4)	Packing Group (5)	Special Provisions (6)	Limited quantities (7a)	Excepted quantities (7b)	Packing		IBC	
								Instructions (8)	Provisions (9)	Instructions (10)	Provisions (11)
3.1.2		2.0	2.0	2.0, 1.3	3.3	3.4	3.5	4.1, 4	4.1, 4	4.1, 4	

3403 POTASSIUM METAL ALLOYS, SOLID 4.3 - I - 0 E0 P403 PPS1 - - T9 TP7 TP3 F-C, S-L Category D. "Separated from" acids. Soft, silvery metal. Flashes on water. Reacts violently with moisture, water reaction. Highly reactive, sometimes with explosive effect. 3403

3404 POTASSIUM SODIUM ALLOYS, SOLID 4.3 - I - 0 E0 P403 PPS1 - - T9 TP7 TP3 F-C, S-L Category D. "Separated from" acids. Soft, silvery metal. Flashes on water. Reacts violently with moisture, water reaction. Highly reactive, sometimes with explosive effect. 3404

3405 BARIUM CHLORATE SOLUTION 5.1 6.1 II - 1 ℓ E2 P504 - IBC02 - - T4 TP1 F-H, S-Q Category A. "Separated from" ammonium compounds, cyanides and sulphur. Colourless aqueous solution. Reacts vigorously with sulphuric acid. Reacts with cyanides when heated. May form explosive mixtures with combustible material, powdered metals or ammonium compounds. These mixtures are liable to ignite. When involved in a fire, may cause an explosion. Toxic if swallowed, by skin contact or by inhalation. Leakage and spillage may cause fire. The water from the solutions may present increased dangers as follows:  
1. in contact with combustible material (particularly fibrous material such as jute, cotton or sisal) or sulphur, danger of spontaneous combustion, danger of explosion;  
2. in contact with ammonium compounds, powdered metals or oils, danger of explosion. 3405

3405 BARIUM CHLORATE SOLUTION 5.1 6.1 III - 223 5 ℓ E1 P001 - IBC02 - - T4 TP1 F-H, S-Q Category A. "Separated from" ammonium compounds, cyanides and sulphur. See entry above. 3405

3406 BARIUM PERCHLORATE SOLUTION 5.1 6.1 II - 1 ℓ E2 P504 - IBC02 - - T4 TP1 F-H, S-Q Category A. "Separated from" ammonium compounds, cyanides and sulphur. Reacts vigorously with sulphuric acid. Reacts fiercely with cyanides when heated. May form explosive mixtures with combustible material, powdered metals or ammonium compounds. These mixtures are liable to ignite. When involved in a fire, may cause an explosion. Leakage and subsequent evaporation of the water from the solutions may present increased dangers as follows:  
1. in contact with combustible material (particularly fibrous material such as jute, cotton or sisal) or sulphur, danger of spontaneous combustion, danger of explosion;  
2. in contact with ammonium compounds, powdered metals or oils, danger of explosion. 3406

3406 BARIUM PERCHLORATE SOLUTION 5.1 6.1 III - 223 5 ℓ E1 P001 - IBC02 - - T4 TP1 F-H, S-Q Category A. "Separated from" ammonium compounds, cyanides and sulphur. See entry above. 3406

3407 CHLORATE AND MAGNESIUM CHLORIDE MIXTURE SOLUTION 5.1 - II - 1 ℓ E2 P504 - IBC02 - - T4 TP1 F-H, S-Q Category A. "Separated from" ammonium compounds, cyanides and sulphur. Reacts vigorously with sulphuric acid. Reacts fiercely with cyanides when powdered metals or ammonium compounds. These mixtures are liable to ignite. When involved in a fire, may cause an explosion. Leakage and subsequent evaporation of the water from the solutions may present increased dangers as follows:  
1. in contact with combustible material (particularly fibrous material such as jute, cotton or sisal) or sulphur, danger of spontaneous combustion, danger of explosion;  
2. in contact with ammonium compounds, powdered metals or oils, danger of explosion. 3407

3407 CHLORATE AND MAGNESIUM CHLORIDE MIXTURE SOLUTION 5.1 - III - 223 5 ℓ E1 P504 - IBC02 - - T4 TP1 F-H, S-Q Category A. "Separated from" ammonium compounds, cyanides and sulphur. See entry above. 3407

3408 LEAD PERCHLORATE SOLUTION 5.1 6.1 P II - 1 ℓ E2 P504 - IBC02 - - T4 TP1 F-H, S-Q Category A. "Separated from" ammonium compounds and cyanides. Reacts vigorously with sulphuric acid. Reacts fiercely with cyanides when heated. May form explosive mixtures with combustible material, powdered metals or ammonium compounds. These mixtures are liable to ignite. When involved in a fire, may cause an explosion. 3408

3408 LEAD PERCHLORATE SOLUTION 5.1 6.1 P III - 223 5 ℓ E1 P001 - IBC02 - - T4 TP1 F-H, S-Q Category A. "Separated from" ammonium compounds and cyanides. See entry above. 3408

3409 CHLORONITROBENZENE, LIQUID 6.1 - II - 279 100 ml<sup>f</sup> E4 P001 - IBC02 - - T7 TP2 F-A, S-A Category A. Yellow liquid. Toxic if swallowed, by skin contact or by inhalation. 3409

3410 4-CHLORO-*o*-TOLUIDINE HYDROCHLORIDE SOLUTION 6.1 - III - 223 5 ℓ E1 P001 - IBC03 - - T4 TP1 F-A, S-A Category A. Toxic if swallowed, by skin contact or by inhalation. 3410



UN No. (1)	PSN (2)	Class No. (3)	Subsidiary Risk(s) (4)	Packing Group (5)	Special Provisions (6)	Limited quantities (7a)	Excepted quantities (7b)	Packaging		IBC		Portable tanks and bulk containers	EMS (15)	Stowage and Segregation (16)	Properties and Observations (17)	UN No. (18)	
								Instructions (8)	Provisions (9)	Instructions (10)	Provisions (11)						Tank instructions (12)
3411	beta-NAPHTHYLAMINE SOLUTION	6.1	-	II	-	100 ml	E4	P001	-	IBC02	-	T7	F-A, S-A	Category A.	Toxic if swallowed, by skin contact or by inhalation.	3411	
3411	beta-NAPHTHYLAMINE SOLUTION	6.1	-	III	223	5 l	E1	P001	-	IBC02	-	T7	F-A, S-A	Category A.	See entry above.	3411	
3412	FORMIC ACID with not less than 10% but not more than 85% acid by mass	8	-	II	-	1 l	E2	P001	-	IBC02	-	T7	F-A, S-B	Category A.	Colourless liquid with a pungent odour. Corrosive to most metals. Causes burns to skin, eyes and mucous membranes.	3412	
3412	FORMIC ACID with not less than 5% but less than 10% acid by mass	8	-	III	-	5 l	E1	P001 LPO1	-	IBC03	-	T4	F-A, S-B	Category A.	Clear of living quarters. See entry above.	3412	
3413	POTASSIUM CYANIDE SOLUTION	6.1	P	I	-	0	E5	P001	PP31	-	-	T14	TP2 TP13	F-A, S-A	Category B.	Reacts with acids or acid fumes, evolving hydrogen cyanide, a highly toxic and flammable gas. Highly toxic if swallowed or by skin contact.	3413
3413	POTASSIUM CYANIDE SOLUTION	6.1	-	II	-	100 ml	E4	P001	PP31	IBC02	-	T11	TP2 TP13 TP27	F-A, S-A	Category B.	"Separated from" acids. See entry above.	3413
3413	POTASSIUM CYANIDE SOLUTION	6.1	P	III	223	5 l	E1	R001 LPO1	PP31	IBC03	-	T7	TP2 TP13 TP28	F-A, S-A	Category A.	"Separated from" acids. See entry above.	3413
3414	SODIUM CYANIDE SOLUTION	6.1	P	I	-	0	E5	P001	PP31	-	-	T14	TP2 TP13	F-A, S-A	Category B.	Reacts with acids or acid fumes, evolving hydrogen cyanide, a highly toxic and flammable gas. Highly toxic if swallowed or by skin contact.	3414
3414	SODIUM CYANIDE SOLUTION	6.1	-	II	-	100 ml	E4	P001	PP31	IBC02	-	T11	TP2 TP13 TP27	F-A, S-A	Category B.	"Separated from" acids. See entry above.	3414
3414	SODIUM CYANIDE SOLUTION	6.1	P	III	223	5 l	E1	P001 LPO1	PP31	IBC03	-	T7	TP2 TP13 TP28	F-A, S-A	Category A.	Reacts with acids or acid fumes, evolving hydrogen cyanide, a highly toxic and flammable gas. Highly toxic if swallowed or by skin contact.	3414
3415	SODIUM FLUORIDE SOLUTION	6.1	-	III	223	5 l	E1	R001 LPO1	-	IBC03	-	T4	TP1	F-A, S-A	Category A.	Colourless liquid. Reacts with acids, evolving hydrogen fluoride, a toxic, corrosive gas. Causes severe burns to skin, eyes and mucous membranes. Toxic if swallowed, by skin contact or by inhalation.	3415
3416	CHLOROACETOPHENONE LIQUID	6.1	-	II	-	0	E4	P001	-	IBC02	-	T7	TP2 TP13	F-A, S-A	Category D.	Keep as cool as reasonably practicable. Clear of living quarters. Liquid evolving irritating vapour ("Tear Gas"). Toxic if swallowed, by skin contact or by inhalation.	3416
3417	XYLYL BROMIDE, SOLID	6.1	-	II	-	0	E4	P002	-	IBC08	B2 B4	T3	TP33	F-A, S-G	Category D.	Clear of living quarters. Crystals or powder, evolving irritating vapour ("Tear Gas"). Toxic if swallowed, by skin contact or by inhalation.	3417
3418	2,4-TOLUYLEDIAMINE SOLUTION	6.1	-	III	223	5 l	E1	P001 LPO1	-	IBC03	-	T4	TP1	F-A, S-A	Category A.	Toxic if swallowed, by skin contact or by inhalation.	3418
3419	BORON TRIFLUORIDE ACETIC ACID COMPLEX, SOLID	8	-	II	-	1 kg	E2	P002	-	IBC08	B2 B4	T3	TP33	F-A, S-B	Category A.	White crystalline solid. Melting point: 23°C. Highly corrosive to most metals. Causes burns to skin, eyes and mucous membranes.	3419

**TSFS 2015:66**  
**Bilaga 1**

UN No. (1)	PSN (2)	Class or Div (3)	Subsidiary Risk(s) (4)	Packing Group (5)	Special Provisions (6)	Limited quantities (7a)	Excepted quantities (7b)	Packing		IBC		Portable tanks and bulk containers	EMs (15)	Stowage and Segregation (16)	Properties and Observations (17)	UN No. (18)
								Instruc-tions (8)	Provisions (9)	Instruc-tions (10)	Provisions (11)					
3420	BORON TRIFLUORIDE PROPIONIC ACID COMPLEX, SOLID	8	-	II	-	1 kg	E2	P002	-	IBC08	B2 B4	T3	TP33	F-A, S-B Category A.	White, crystalline solid. Melting point: 28°C. Highly corrosive to most metals. Causes burns to skin, eyes and mucous membranes.	3420
3421	POTASSIUM HYDROGEN DIFLUORIDE SOLUTION	8	6.1	II	-	1 ℓ	E2	P001	-	IBC02	-	T7	TP2	F-A, S-B Category A. Protected from sources of heat. Clear of living quarters.	Decomposed by heat or acids, evolving hydrogen fluoride, a toxic corrosive gas. Causes burns to skin, eyes and mucous membranes. In the presence of moisture, highly corrosive to glass, other siliceous materials and most metals. Toxic if swallowed, by skin contact or by inhalation. Causes burns to skin, eyes and mucous membranes.	3421
3421	POTASSIUM HYDROGEN DIFLUORIDE SOLUTION	8	6.1	III	223	5 ℓ	E1	P001	-	IBC03	-	T4	TP1	F-A, S-B Category A. Protected from sources of heat. Clear of living quarters.	See entry above.	3421
3422	POTASSIUM FLUORIDE SOLUTION	6.1	-	III	223	5 ℓ	E1	P001 LP01	-	IBC03	-	T4	TP1	F-A, S-B Category A. "Separated from" acids.	Decomposed by acids, evolving hydrogen fluoride, an irritating and corrosive gas. Toxic if swallowed, by skin contact or by inhalation.	3422
3423	TETRAMETHYLAMMONIUM HYDROXIDE, SOLID	8	-	II	-	1 kg	E2	P002	-	IBC08	B2 B4	T3	TP33	F-A, S-B Category A. "Separated from" acids.	Very soluble in water. Reacts violently with acids.	3423
3424	AMMONIUM DINITRO- <i>o</i> -CRESOLATE SOLUTION	6.1	P	II	-	100 ml	E4	P001	-	IBC02	-	T7	TP2	F-A, S-A Category B. "Away from" heavy metals and their salts. "Separated from" classes 3 and 4.1. "Separated longitudinally by an intervening complete compartment or hold from" class 1.	The commercial product is a 50% suspension in water. May support combustion and burn without oxygen. When involved in a fire, evolves toxic fumes. Forms extremely sensitive explosive compounds with lead, silver or other heavy metals and their compounds. Toxic if swallowed, by skin contact or by inhalation.	3424
3424	AMMONIUM DINITRO- <i>o</i> -CRESOLATE SOLUTION	6.1	P	III	223	5 ℓ	E1	P001	-	IBC02	-	T7	TP2	F-A, S-A Category A. "Away from" heavy metals and their salts. "Separated longitudinally by an intervening complete compartment or hold from" class 1.	See entry above.	3424
3425	BROMOACETIC ACID, SOLID	8	-	II	-	1 kg	E2	P002	-	IBC08	B2 B4	T3	TP33	F-A, S-B Category A.	Colourless, deliquescent crystals. Melting point: 51°C Corrosive to most metals. Flammable if swallowed. Causes burns to eyes and skin.	3425
3426	ACRYLAMIDE SOLUTION	6.1	-	III	223	5 ℓ	E1	P001 LP01	-	IBC03	-	T4	TP1	F-A, S-A Category A. Keep as cool as reasonably practicable.	Toxic if swallowed, by skin contact or by inhalation.	3426
3427	CHLOROBENZYL CHLORIDES, SOLID	6.1	P	III	-	5 kg	E1	P002 LP02	-	IBC08	B3	T1	TP33	F-A, S-A Category A.	Colourless crystalline solid. Melting point: 20°C. Immiscible with or insoluble in water. Toxic if swallowed, by skin contact or by inhalation.	3427
3428	3-CHLORO-4-METHYLPHENYLSULFONATE, SOLID	6.1	-	II	-	500 g	E4	P002	-	IBC08	B2 B4	T3	TP33	F-A, S-A Category B. Clear of living quarters.	Colourless solid with a pungent odour. Melting point: 23°C. Insoluble in water. Reacts with water, evolving carbon dioxide. Toxic if swallowed, by skin contact or by inhalation. Irritating to skin, eyes and mucous membranes.	3428
3429	CHLOROTOLUENES, LIQUID	6.1	-	III	-	5 ℓ	E1	P001 LP01	-	IBC03	-	T4	TP1	F-A, S-A Category A.	Brown liquid. Toxic if swallowed, by skin contact or by inhalation.	3429
3430	XYLENOLS, LIQUID	6.1	-	II	-	100 ml	E4	P001	-	IBC02	-	T7	TP2	F-A, S-A Category A.	The commercial products are liquids with a pungent tar odour. Toxic if swallowed, by skin contact or by inhalation.	3430
3431	NITROBENZOTRIFLUORIDES, SOLID	6.1	P	II	-	500 g	E4	P002	-	IBC08	B2 B4	T3	TP33	F-A, S-A Category A. Clear of living quarters.	Low melting point (31°C to 32°C) solids with an aromatic odour. Insoluble in water. Toxic if swallowed, by skin contact or by inhalation.	3431
3432	POLYCHLORINATED BIPHENYLS, SOLID	9	P	II	305 958	1 kg	E2	P906	-	IBC08	B2 B4	T3	TP33	F-A, S-A Category A. Segregation from foodstuffs as in 7.3.4.2.1, 7.6.3.1.2 or 7.7.3.6.	Solid with perceptible odour. Insoluble in water. Harmful by ingestion or by skin contact. Expired can be a persistent hazard to the environment. This entry covers articles, such as rags, cotton waste, clothing, sawdust, containing polychlorinated biphenyls where no free visible liquid is present.	3432

UN No. (1)	PSN (2)	Class No. (3)	Subsidiary Risk(s) (4)	Packing Group (5)	Special Provisions (6)	Limited quantities (7a)	Excepted quantities (7b)	Packing		IBC		Portable tanks and bulk containers		EMSS (15)	Stowage and Segregation (16)	Properties and Observations (17)	UN No. (18)
								Instructions (8)	Provisions (9)	Institutions (10)	Provisions (11)	Tank instructions (12)	Provisions (13)				
3434	NITRORESOLS, LIQUID	6.1	-	III	-	5 l	E1	P001 LP01	-	IBC03	-	T4	TP1	F-A, S-A	Category A.	Slightly miscible in water. Toxic if swallowed, by skin contact or by inhalation.	3434
3436	HEXaFLUOROACETONE HYDRATE, SOLID	6.1	-	II	-	500 g	E4	P002	-	IBC08 B2 B4	-	T3	TP33	F-A, S-A	Category B.	This entry covers solid hydrate and hexafluoroacetone. Melting point of the pure substance: 23 °C. Toxic if swallowed, by skin contact or by inhalation.	3436
3437	CHLOROCRESOLS, SOLID	6.1	-	II	-	500 g	E4	P002	-	IBC08 B2 B4	-	T3	TP33	F-A, S-A	Category A.	White or pink crystals with a phenol-like odour. Melting point: 45°C to 68°C. Slightly soluble in water. Dimerizes when heated, evolving extremely toxic fumes (phosgene). Toxic if swallowed, by skin contact or by inhalation.	3437
3438	alpha-METHYLBENZYL ALCOHOL, SOLID	6.1	-	III	-	5 kg	E1	P002 LP02	-	IBC08 B3	-	T1	TP33	F-A, S-A	Category A.	Slightly soluble in water. Melting point: 21°C (pure substance). Toxic if swallowed, by skin contact or by inhalation.	3438
3439	NITRILES, SOLID, TOXIC, N.O.S.	6.1	-	I	274	0	E5	P002	-	IBC07 B1	-	T6	TP33	F-A, S-A	Category B.	Solid, evolving toxic vapours. Reacts with acids or acid fumes, evolving hydrogen cyanide, a highly toxic and flammable gas. Soluble in water. Toxic if swallowed, by skin contact or by inhalation.	3439
3439	NITRILES, SOLID, TOXIC, N.O.S.	6.1	-	II	274	500 g	E4	P002	-	IBC08 B2 B4	-	T3	TP33	F-A, S-A	Category B.	"Separated from" acids. See entry above.	3439
3439	NITRILES, SOLID, TOXIC, N.O.S.	6.1	-	III	223 274	5 kg	E1	P002 LP02	-	IBC08 B3	-	T1	TP33	F-A, S-A	Category A.	"Separated from" acids. See entry above.	3439
3440	SELENIUM COMPOUND, LIQUID, N.O.S.	6.1	-	I	274	0	E5	P001	-	-	-	T14	TP2 TP27	F-A, S-A	Category B.	Toxic if swallowed, by skin contact or by inhalation.	3440
3440	SELENIUM COMPOUND, LIQUID, N.O.S.	6.1	-	II	274	100 ml	E4	P001	-	IBC02 -	-	T11	TP2 TP27	F-A, S-A	Category B.	See entry above.	3440
3440	SELENIUM COMPOUND, LIQUID, N.O.S.	6.1	-	III	223 274	5 l	E1	P001	-	IBC03 -	-	T7	TP1 TP28	F-A, S-A	Category A.	See entry above.	3440
3441	CHLORONITROBENZENES, SOLID	6.1	-	II	279	500 g	E4	P002	-	IBC08 B2 B4	-	T3	TP33	F-A, S-A	Category A.	Crystals. Melting point: 27°C to 53°C. May explode if involved in a fire. Toxic if swallowed, by skin contact or by inhalation.	3441
3442	DICHLOROANILINES, SOLID	6.1	-	II	279	500 g	E4	P002	-	IBC08 B2 B4	-	T3	TP33	F-A, S-A	Category A.	Solid with a penetrating odour. Liquid mixtures of various isomers of dichloroanilines, some of which in the pure state may be solid, with a melting point varying from 24°C to 72°C. Toxic if swallowed, by skin contact or by inhalation.	3442
3443	DINITROBENZENES, SOLID	6.1	-	II	-	500 g	E4	P002	-	IBC08 B2 B4	-	T3	TP33	F-A, S-A	Category A.	May explode if involved in a fire. Toxic if swallowed, by skin contact or by inhalation.	3443
3444	NICOTINE HYDROCHLORIDE, SOLID	6.1	-	II	43	500 g	E4	P002	-	IBC08 B2 B4	-	T3	TP33	F-A, S-A	Category A.	Deliquescent crystals or solids or pastes. Soluble in water. Toxic if swallowed, by skin contact or by inhalation.	3444
3445	NICOTINE SULPHATE, SOLID	6.1	-	II	-	500 g	E4	P002	-	IBC08 B2 B4	-	T3	TP33	F-A, S-A	Category A.	Solid or paste. Soluble in water. Toxic if swallowed, by skin contact or by inhalation.	3445

**TSFS 2015:66**  
**Bilaga 1**

UN No. (1)	PSN (2)	Class (3)	Subsidiary Risk(s) (4)	Packing Group (5)	Special Provisions (6)	Limited quantities (7a)	Excepted quantities (7b)	Packing		IBC		Portable tanks and bulk containers		EMSS (15)	Stowage and Segregation (16)	Properties and Observations (17)	UN No. (18)
								Institutions (8)	Provisions (9)	Institutions (10)	Provisions (11)	Tank instructions (12)	Provisions (13)				
	3.1.2	2.0	2.0	2.0, 1.3	3.3	3.4	3.5	4.1, 4	P002	-	IBC08	B2	B4			Yellow solid. Melting point: para-NITROTOLUENE 52°C to 54°C. Toxic if swallowed, by skin contact or by inhalation.	3446
3446	NITROTOLUENES, SOLID	6.1	-	II	-	500 g	E4		P002	-	IBC08	B2	B4				
3447	NITROXYLENES, SOLID	6.1	-	II	-	500 g	E4		P002	-	IBC08	B2	B4			Yellow solid. Melting points: 4-NITRO-2-XYLENE: 29°C to 31°C, 5-NITRO-3-XYLENE: 72°C to 74°C. Insoluble in water. Toxic if swallowed, by skin contact or by inhalation.	3447
3448	TEAR GAS SUBSTANCE, SOLID, N.O.S.	6.1	-	I	274	0	E5		P002	PP31	-	-	-			"Tear gas substances" is a generic term for substances which, in minute quantities dispersed in air, cause extreme eye irritation and profuse tears. Toxic if swallowed, by skin contact or by inhalation.	3448
3448	TEAR GAS SUBSTANCE, SOLID, N.O.S.	6.1	-	II	274	0	E4		P002	PP31	IBC08	B2	B4			See entry above.	3448
3449	BROMOBENZYL CYANIDES, SOLID	6.1	-	I	138	0	E5		P002	PP31	-	-	-			Volatile, yellow crystals evolving irritating vapours ("Tear Gas"). Melting point: meta-BROMOBENZYL CYANIDE 25°C. Highly toxic if swallowed, by skin contact or by inhalation.	3449
3450	DIPHENYLCHLORARSINE, SOLID	6.1	-	P	-	0	E5		P002	PP31	IBC07	B1				Wishy pure, volatile, colourless crystals evolving an irritating vapour ("Tear Gas"). Melting point: 41°C. Highly toxic if swallowed, by skin contact or by inhalation.	3450
3451	TOLUIDINES, SOLID	6.1	-	II	279	500 g	E4		P002	-	IBC08	B2	B4			para-TOLUIDINE is solid in pure form, with a melting point of approximately 45°C. Toxic if swallowed, by skin contact or by inhalation.	3451
3452	XYLIDINES, SOLID	6.1	-	II	-	500 g	E4		P002	-	IBC08	B2	B4			3,4-dimethylamine is a solid, which has a melting point of 47°C. Toxic if swallowed, by skin contact or by dust inhalation.	3452
3453	PHOSPHORIC ACID, SOLID	8	-	III	-	5 kg	E1		P002	LPO2	IBC08	B3				Very deliquescent, crystalline solid. Melting point: 42°C. Soluble in water. Mildly corrosive to most metals.	3453
3454	DINITROTOLUENES, SOLID	6.1	-	II	-	500 g	E4		P002	-	IBC08	B2	B4			Yellow crystals or flakes, insoluble in water. Toxic if swallowed, by skin contact or by inhalation.	3454
3455	CRESOLS, SOLID	6.1	8	II	-	500 g	E4		P002	-	IBC08	B2	B4			Light yellow solid. Soluble in water. Melting points of CRESOL: ortho-CRESOL: 30°C, meta-CRESOL: 35°C, para-CRESOL: 38°C. Toxic if swallowed, by skin contact or by inhalation. Cause burns to skin, eyes and mucous membranes.	3455
3456	NITROSYLSULPHURIC ACID, SOLID	8	-	II	-	1 kg	E2		P002	-	IBC08	B2	B4			Crystalline solid. Oxidant which may cause fire with organic materials (such as wood, straw, etc.) When involved in a fire, evolves toxic gases. In presence of moisture, highly corrosive to most metals. Causes burns to skin, eyes and mucous membranes.	3456
3457	CHLORONITROTOLUENES, SOLID	6.1	-	III	-	5 kg	E1		P002	LPO2	IBC08	B3				Melting range 20°C to 40°C. Insoluble in water. Oxidizing substance which may explode or burn fiercely when in contact with organic materials. Toxic if swallowed, by skin contact or by inhalation.	3457
3458	NITROANISOLE, SOLID	6.1	-	III	279	5 kg	E1		P002	LPO2	IBC08	B3				Light reddish or amber crystals. Melting point: 38°C to 54°C. Insoluble in water. Toxic if swallowed, by skin contact or by inhalation.	3458
3459	NITROBROMOBENZENES, SOLID	6.1	-	III	-	5 kg	E1		P002	LPO2	IBC08	B3				Colourless to pale yellow crystals which may liquefy under transport conditions. Melting points: 1-BROMO-2-NITROBENZENE: 43°C, 1-BROMO-4-NITROBENZENE: 127°C. Insoluble in water. Toxic if swallowed, by skin contact or by inhalation.	3459
3460	N-ETHYLBENZYL TOLUIDINES, SOLID	6.1	-	III	-	5 kg	E1		P002	LPO2	IBC08	B3				Solid which may liquefy under transport conditions. Strong odour. Insoluble in water. Toxic if swallowed, by skin contact or by inhalation.	3460

UN No. (1)	PSN (2)	Class No. (3)	Subsidiary Risk(s) (4)	Packing Group (5)	Special Provisions (6)	Limited quantities (7a)	Excepted quantities (7b)	Packing			IBC			UN No. (18)
								Class (5)	Subsidiary Risk(s) (4)	Packing Group (5)	Institutions (8)	Provisions (9)	Institutions (10)	
3462	TOXINS, EXTRACTED FROM LIVING SOURCES, SOLID, N.O.S.	6.1	-	I	210 274	0	E5	P002	-	IBC07	B1		3462	
3462	TOXINS, EXTRACTED FROM LIVING SOURCES, SOLID, N.O.S.	6.1	-	II	210 274	500 g	E4	P002	-	IBC08	B2 B4		3462	
3462	TOXINS, EXTRACTED FROM LIVING SOURCES, SOLID, N.O.S.	6.1	-	III	210 223 274	5 kg	E1	P002	-	IBC08	B3		3462	
3463	PROPIONIC ACID with not less than 90% acid, by mass	8	3	II	-	1 l	E2	P001	-	IBC02	-		3463	
3464	ORGANOPHOSPHORUS COMPOUND, SOLID, TOXIC, N.O.S.	6.1	-	I	43 274	0	E5	P002	-	IBC07	B1		3464	
3464	ORGANOPHOSPHORUS COMPOUND, SOLID, TOXIC, N.O.S.	6.1	-	II	43 274	500 g	E4	P002	-	IBC08	B2 B4		3464	
3464	ORGANOPHOSPHORUS COMPOUND, SOLID, TOXIC, N.O.S.	6.1	-	III	43 223 274	5 kg	E1	P002 LP02	-	IBC08	B3		3464	
3465	ORGANARSENIC COMPOUND, SOLID, N.O.S.	6.1	-	I	274	0	E5	P002	-	IBC07	B1		3465	
3465	ORGANARSENIC COMPOUND, SOLID, N.O.S.	6.1	-	II	274	500 g	E4	P002	-	IBC08	B2 B4		3465	
3465	ORGANARSENIC COMPOUND, SOLID, N.O.S.	6.1	-	III	223 274	5 kg	E1	P002 LP02	-	IBC08	B3		3465	
3466	METAL CARBONYLS, SOLID, N.O.S.	6.1	-	I	274	0	E5	P002	-	IBC07	B1		3466	
3466	METAL CARBONYLS, SOLID, N.O.S.	6.1	-	II	274	500 g	E4	P002	-	IBC08	B2 B4		3466	
3466	METAL CARBONYLS, SOLID, N.O.S.	6.1	-	III	223 274	5 kg	E1	P002 LP02	-	IBC08	B3		3466	
3467	ORGANOMETALLIC COMPOUND, SOLID, TOXIC, N.O.S.	6.1	-	I	274	0	E5	P002	-	IBC07	B1		3467	
3467	ORGANOMETALLIC COMPOUND, SOLID, TOXIC, N.O.S.	6.1	-	II	274	500 g	E4	P002	-	IBC08	B2 B4		3467	
3467	ORGANOMETALLIC COMPOUND, SOLID, TOXIC, N.O.S.	6.1	-	III	223 274	5 kg	E1	P002 LP02	-	IBC08	B3		3467	

UN No. (18)	Properties and Observations (17)	Stowage and Segregation (16)	Portable tanks and bulk containers			Category
			Tank instructions (15)	Provisions (14)	EMs (15)	
3462	Toxins from plant, animal or bacterial sources which contain infectious agents should be classified in class 6.2. Toxic if swallowed, by skin contact or by inhalation.	7.1 to 7.7	4.2.5 4.3	4.2.5	F-A, S-A	Category B.
3462	See entry above.				F-A, S-A	Category B.
3462	See entry above.				F-A, S-A	Category A.
3463	Colourless flammable liquid with a pungent odour. Miscible with water. Insoluble in alcohol. Vapour irritates mucous membranes. Pure PROPIONIC ACID. Flashpoint 50°C C.C.				F-E, C	Category A.
3464	Toxic if swallowed, by skin contact or by inhalation.				F-A, S-A	Category B.
3464	See entry above.				F-A, S-A	Category B.
3464	See entry above.				F-A, S-A	Category A.
3465	Toxic if swallowed, by skin contact or by inhalation.				F-A, S-A	Category B.
3465	See entry above.				F-A, S-A	Category B.
3465	See entry above.				F-A, S-A	Category A.
3466	Insoluble in water. Toxic if swallowed, by skin contact or by dust inhalation.				F-A, S-A	Category D. Clear of living quarters.
3466	See entry above.				F-A, S-A	Category D. Clear of living quarters. See entry above.
3466	See entry above.				F-A, S-A	Category D. Clear of living quarters. See entry above.
3467	Toxic if swallowed, by skin contact or by inhalation.				F-A, S-A	Category B.
3467	See entry above.				F-A, S-A	Category B.
3467	See entry above.				F-A, S-A	Category A.

**TSFS 2015:66**  
**Bilaga 1**

UN No. (1)	PSN (2)	Class No. (3)	Subsidiary Risk(s) (4)	Packing Group (5)	Special Provisions (6)	Limited quantities (7a)	Excepted quantities (7b)	Packing		IBC		Provisiones (15)	Tank instructions (16)	Stowage and Segregation (16)	Properties and Observations (17)	UN No. (18)
								Instructions (8)	Provisions (9)	Instructions (10)	Provisions (11)					
	3.1.2	2.0	2.0	2.0, 1.3	3.3	3.4	3.5	4.1, 4	4.1, 4	4.1, 4	4.1, 4	4.2, 5 4.3	4.2, 5 7.8	7.1 to 7.7		
3468	HYDROGEN IN A METAL HYDRIDE STORAGE SYSTEM or HYDROGEN IN A METAL HYDRIDE STORAGE SYSTEM CONTAINED IN EQUIPMENT or HYDROGEN IN A METAL HYDRIDE STORAGE SYSTEM PACKED WITH EQUIPMENT	2.1	-	-	371 376	0	EO	P205	-	-	-	-	-	Article containing flammable odourless gas, which is much lighter than air.	3468	
3469	PAINT, FLAMMABLE, CORROSIVE (including paint, lacquer, enamel, stain, shellac, varnish, polish, liquid filler and liquid lacquer base or PAINT RELATED MATERIAL, FLAMMABLE, CORROSIVE (including paint thinning or reducing compound)	3	8	I	163	0	EO	P001	-	-	-	T11	TP2	Category E. Clear of living quarters. Miscibility with water depends upon the composition. Corrosive contents cause burns to skin, eyes and mucous membranes.	3469	
3469	PAINT, FLAMMABLE, CORROSIVE (including paint, lacquer, enamel, stain, shellac, varnish, polish, liquid filler and liquid lacquer base or PAINT RELATED MATERIAL, FLAMMABLE, CORROSIVE (including paint thinning or reducing compound)	3	8	II	163	1 ℓ	E2	P001	-	IBC02	-	T7	TP2 TP8 TP28	Category B. Clear of living quarters. See entry above. See entry above.	3469	
3469	PAINT, FLAMMABLE, CORROSIVE (including paint, lacquer, enamel, stain, shellac, varnish, polish, liquid filler and liquid lacquer base or PAINT RELATED MATERIAL, CORROSIVE, FLAMMABLE (including paint thinning or reducing compound)	3	8	III	163	5 ℓ	E1	P001	-	IBC03	-	T4	TP1 TP29	Category A. Clear of living quarters. See entry above. See entry above.	3469	
3470	PAINT, CORROSIVE, FLAMMABLE (including paint, lacquer, enamel, stain, shellac, varnish, polish, liquid filler and liquid lacquer base or PAINT RELATED MATERIAL, CORROSIVE, FLAMMABLE (including paint thinning or reducing compound)	8	3	II	163	1 ℓ	E2	P001	-	IBC02	-	T7	TP2 TP8 TP28	Category B. Clear of living quarters. Miscibility with water depends upon the composition. Corrosive contents cause burns to skin, eyes and mucous membranes.	3470	
3471	HYDROGEN FLUORIDES SOLUTION, N.O.S.	8	6.1	II	-	1 ℓ	E2	P001	-	IBC02	-	T7	TP2	Category A. Protected from sources. When involved in a fire or in contact with acids, evolves hydrogen fluoride, an extremely irritating and corrosive gas. Corrosive to glass, other siliceous materials and most metals. Toxic if swallowed, by skin contact or by inhalation. Causes burns to skin, eyes and mucous membranes.	3471	
3471	HYDROGEN FLUORIDES SOLUTION, N.O.S.	8	6.1	III	223	5 ℓ	E1	P001	-	IBC03	-	T4	TP1	Category A. Protected from sources. See entry above. Separated from acids.	3471	
3472	CROTIC ACID, LIQUID	8	-	III	-	5 ℓ	E1	P001 UP01	-	IBC03	-	T4	TP1	Category A. Keep as cool as reasonably practicable. Causes burns to skin, eyes and mucous membranes.	3472	
3473	FUEL CELL CARTRIDGES or FUEL CELL CARTRIDGES CONTAINED IN EQUIPMENT or FUEL CELL CARTRIDGES PACKED WITH EQUIPMENT containing flammable liquids	3	-	-	328	1 ℓ	EO	P004	-	-	-	-	-	Category A. Fuel cell cartridges containing flammable liquids including methanol or methanol/water solutions. Fuel cell cartridges may also be shipped in, or packed with, equipment.	3473	
3474	1-HYDROBENZOTRIAZOLE MONOHYDRATE	4.1	-	I	-	0	EO	P406	PH48	-	-	-	-	Category D. "Away from" class 3 and flammable liquids and their salts. Desensitized explosive. White to light beige powder. Explosive and toxic when heated. In closed compartments these fumes may form an explosive mixture with air. May form extremely sensitive compounds with heavy metals or their salts.	3474	
3475	ETHANOL AND GASOLINE MIXTURE or ETHANOL AND MOTOR SPIRIT MIXTURE or ETHANOL AND PETROL MIXTURE, with more than 10% ethanol	3	-	II	333 363	1 ℓ	E2	P001	-	IBC02	-	T4	TP1	Category E. Colourless, volatile liquids. Miscibility with water depends on the composition.	3475	
3476	FUEL CELL CARTRIDGES or FUEL CELL CARTRIDGES CONTAINED IN EQUIPMENT or FUEL CELL CARTRIDGES PACKED WITH EQUIPMENT, containing water-reactive substances	4.3	-	-	328 334	500 ml	EO	P004	-	-	-	-	-	Category A. Fuel cell cartridges containing water-reactive substances may also be shipped in, or packed with, equipment.	3476	
3477	FUEL CELL CARTRIDGES or FUEL CELL CARTRIDGES CONTAINED IN EQUIPMENT or FUEL CELL CARTRIDGES PACKED WITH EQUIPMENT, containing corrosive substances	8	-	-	328 334	1 ℓ	EO	P004	-	-	-	-	-	Category A. Fuel cell cartridges containing corrosive substances may also be shipped in, or packed with, equipment.	3477	
3478	FUEL CELL CARTRIDGES or FUEL CELL CARTRIDGES CONTAINED IN EQUIPMENT or FUEL CELL CARTRIDGES PACKED WITH EQUIPMENT, containing liquefied flammable gas	2.1	-	-	328 338	120 ml	EO	P004	-	-	-	-	-	Category B. Fuel cell cartridges containing butane or other flammable liquefied gas may also be shipped in, or packed with, equipment.	3478	
3479	FUEL CELL CARTRIDGES or FUEL CELL CARTRIDGES CONTAINED IN EQUIPMENT or FUEL CELL CARTRIDGES PACKED WITH EQUIPMENT, containing hydrogen in metal hydride	2.1	-	-	328 339	120 ml	EO	P004	-	-	-	-	-	Category B. Fuel cell cartridges containing hydrogen, butane or other flammable odourless gas, which is much lighter than air, may also be shipped in, or packed with, equipment.	3479	

UN No. (1)	PSN (2)	Class No./Div (5)	Subsidiary Risk(s) (4)	Packing Group (3)	Special Provisions (6)	Limited quantities (7a)	Excepted quantities (7b)	Packing		IBC		Portable tanks and bulk containers		EMs (15)	Stowage and Segregation (16)	Properties and Observations (17)	UN No. (18)
								Instruc-tions (8)	Provisions (9)	Instruc-tions (10)	Provisions (11)	Tank instructions (12)	Provisions (13)				
3480	LITHIUM ION BATTERIES (including lithium ion polymer batteries)	9	-	II	188 230 310 348 957	0	EO	P903	-	-	-	-	-	F-A, S-1	Category A.	Electrical batteries containing lithium ion enclosed in a rigid metallic body, which may be ignited by the heat of the reaction. Electrical lithium batteries may cause fire due to an explosive rupture of the body caused by improper construction or reaction with contaminants.	3480
3481	LITHIUM ION BATTERIES CONTAINED IN EQUIPMENT or LITHIUM ION BATTERIES PACKED WITH EQUIPMENT (including lithium ion polymer batteries)	9	-	II	188 230 348 957	0	EO	P903	-	-	-	-	-	F-A, S-1	Category A.	Electrical batteries containing lithium ion enclosed in a rigid metallic body. Lithium ion batteries may also be shipped in, or packed with, equipment. Electrical lithium batteries may cause fire due to an explosive rupture of the body caused by improper construction or reaction with contaminants.	3481
3482	ALKALI METAL DISPERSION, FLAMMABLE or ALKALINE EARTH METAL DISPERSION, FLAMMABLE	4.3	3	I	182 103	0	EO	P402	PP31	-	-	-	-	F-C, S-N	Category D. Separated from acids	Finely divided alkali or alkaline earth metal suspended in a flammable liquid, which may be ignited by the heat of the reaction, evolving hydrogen, which may be ignited by the heat of the reaction.	3482
3483	MOTOR FUEL ANTI-KNOCK MIXTURE, FLAMMABLE	6.1	3	I	-	0	E5	P602	-	-	-	T14	TP2 TP3	F-E, S-D	Category D. Clear of living quarters. Protected from sources of heat.	Volatile flammable liquids evolving toxic vapour. Mixture of tetraethyllead or tetramethyllead with ethylene dibromide and ethylene dichloride. Insoluble in water. Highly toxic if swallowed, by skin contact or by inhalation.	3483
3484	HYDRAZINE AQUEOUS SOLUTION, FLAMMABLE, with more than 37% hydrazine, by mass	8	3	I	-	0	EO	P001	-	-	-	T10	TP2 TP3	F-E, S-C	Category D. Clear of living quarters. Segregation as for Class 3, but from Class 4.1. Separated from acids.	Colourless flammable liquid. Powerful reducing agent, burns readily. Toxic if swallowed, by skin contact or by inhalation. Causes burns to skin, eyes and mucous membranes. Reacts violently with acids.	3484
3485	CALCIUM HYPOCHLORITE, DRY, CORROSIVE or CALCIUM HYPOCHLORITE MIXTURE, DRY, CORROSIVE with more than 3% available chlorine (8.8% available oxygen)	5.1	8	II	314	1 kg	E2	P002	PP85	-	-	-	-	F-H, S-Q	Category D. Protected from sources of heat.	White or yellowish corrosive solid (powder, granules or tablets) with chlorine-like odour. Soluble in water. May cause fire in contact with organic material or ammonium compounds. Substances are liable to exothermic decomposition at elevated temperatures. This condition may lead to fire or explosion. Decomposition can be initiated by heat or by impact (e.g. during transport). Decomposition may be initiated by heat or by impurities (e.g. powdered metals (iron, manganese, cobalt, magnesium) and their compounds). Liable to heat slowly. Reacts with acids, evolving chlorine, an irritating, corrosive and toxic gas. In the presence of moisture, corrosive to most metals. Causes burns to skin, eyes and mucous membranes.	3485
3486	CALCIUM HYPOCHLORITE MIXTURE, DRY, CORROSIVE with more than 10% but not more than 35% available chlorine	5.1	8	III	314	5 kg	E1	P002	PP85	-	-	-	-	F-H, S-Q	Category D. Protected from sources of heat.	White or yellowish corrosive solid (powder, granules or tablets) with chlorine-like odour. Soluble in water. May cause fire in contact with organic material or ammonium compounds. Substances are liable to exothermic decomposition at elevated temperatures. This condition may lead to fire or explosion. Decomposition can be initiated by heat or by impurities (e.g. powdered metals (iron, manganese, cobalt, magnesium) and their compounds). Liable to heat slowly. Reacts with acids, evolving chlorine, an irritating, corrosive and toxic gas. In the presence of moisture, corrosive to most metals. Causes burns to skin, eyes and mucous membranes.	3486
3487	CALCIUM HYPOCHLORITE, HYDRATED, CORROSIVE or CALCIUM HYPOCHLORITE MIXTURE, HYDRATED, CORROSIVE, with not less than 5.5% but not more than 16% water	5.1	8	II	314 322	1 kg	E2	P002	PP85	-	-	-	-	F-H, S-Q	Category D. Protected from sources of heat.	White or yellowish corrosive solid (powder, granules or tablets) with chlorine-like odour. Soluble in water. May cause fire in contact with organic material or ammonium compounds. Substances are liable to exothermic decomposition at elevated temperatures. This condition may lead to fire or explosion. Decomposition can be initiated by heat or by impurities (e.g. powdered metals (iron, manganese, cobalt, magnesium) and their compounds). Liable to heat slowly. Reacts with acids, evolving chlorine, an irritating, corrosive and toxic gas. In the presence of moisture, corrosive to most metals. Causes burns to skin, eyes and mucous membranes.	3487
3488	CALCIUM HYPOCHLORITE, HYDRATED, CORROSIVE or CALCIUM HYPOCHLORITE MIXTURE, HYDRATED, CORROSIVE, with not less than 5.5% but not more than 16% water	5.1	8	III	223 314	5 kg	E1	P002	PP85	-	-	-	-	F-H, S-Q	Category D. Protected from sources of heat.	White or yellowish corrosive solid (powder, granules or tablets) with chlorine-like odour. Soluble in water. May cause fire in contact with organic material or ammonium compounds. Substances are liable to exothermic decomposition at elevated temperatures. This condition may lead to fire or explosion. Decomposition can be initiated by heat or by impurities (e.g. powdered metals (iron, manganese, cobalt, magnesium) and their compounds). Liable to heat slowly. Reacts with acids, evolving chlorine, an irritating, corrosive and toxic gas. In the presence of moisture, corrosive to most metals. Causes burns to skin, eyes and mucous membranes.	3488
3488	TOXIC BY INHALATION LIQUID, FLAMMABLE, CORROSIVE, N.O.S. with an LC50 lower than or equal to 200 ml/m <sup>3</sup> vapour concentration or greater than or equal to 500 LC50	6.1	3	I	274	0	EO	P601	-	-	-	T22	TP2 TP3	F-E, S-D	Category D. Clear of living quarters. Segregation as for Class 3 but "away" from Class 4.1.	A variety of toxic liquids which present a highly toxic inhalation hazard as well as being flammable and corrosive. Highly toxic if swallowed, by skin contact or by inhalation. Causes burns to skin, eyes and mucous membranes.	3488

**TSFS 2015:66**  
**Bilaga 1**

UN No. (1)	PSN (2)	Class No. (3)	Subsidiary Risk(s) (4)	Packing Group (5)	Special Provisions (6)	Limited quantities (7a)	Excepted quantities (7b)	Packing		IBC	
								Instructions (8)	Provisions (9)	Instructions (10)	Provisions (11)
312		2.0	2.0	2.0	3.3	3.4	3.5	4.1, 4	4.1, 4		

UN No. (1)	PSN (2)	Class No. (3)	Subsidiary Risk(s) (4)	Packing Group (5)	Special Provisions (6)	Limited quantities (7a)	Excepted quantities (7b)	Instructions (8)	Provisions (9)	Instructions (10)	Provisions (11)	EMSS (15)	Stowage and Segregation (16)	Properties and Observations (17)	UN No. (18)
3489	TOXIC BY INHALATION LIQUID, FLAMMABLE, CORROSIVE, TOXIC, N.O.S. with an energy storage capacity greater than or equal to 10 LC50	6.1	3	I	274	0	EO	P602	-	-	-	F-E, S-D	Category D. Clear of living quarters. Segregation as for class 3 but "away from" class 4.1.	A variety of toxic liquids which present a highly toxic inhalation hazard as well as being water-reactive and flammable. Causes burns to skin, eyes and mucous membranes.	3489
3490	TOXIC BY INHALATION LIQUID, WATER, REACTIVE, FLAMMABLE, N.O.S. with an LC50 lower than or equal to 200 ml/m <sup>3</sup> and saturated vapour concentration greater than or equal to 500 LC50	6.1	4.3	I	274	0	EO	P601	-	-	-	F-C, S-N	Category D. Clear of living quarters. Segregation as for class 3 but "away from" classes 3 and 8.	A variety of toxic liquids which present a highly toxic inhalation hazard as well as being water-reactive and flammable. Highly toxic if swallowed, by skin contact or by inhalation.	3490
3491	TOXIC BY INHALATION LIQUID, WATER, REACTIVE, FLAMMABLE, N.O.S. with an LC50 lower than or equal to 1000 ml/m <sup>3</sup> and saturated vapour concentration greater than or equal to 10 LC50	6.1	4.3	I	274	0	EO	P602	-	-	-	F-C, S-N	Category D. Clear of living quarters. Segregation as for class 3 but "away from" classes 3 and 8.	A variety of toxic liquids which present a highly toxic inhalation hazard as well as being water-reactive and flammable. Highly toxic if swallowed, by skin contact or by inhalation.	3491
3494	PETROLEIUM SOUR CRUDE OIL, FLAMMABLE, TOXIC	3	6.1	I	343	0	EO	P001	-	-	-	F-E, S-E	Category D. Clear of living quarters.	Irresoluble with water. Evolves hydrogen sulphide, which is a flammable, toxic gas with a foul odour, heavier than air (1.2). Toxic if swallowed, by skin contact or by inhalation.	3494
3494	PETROLEIUM SOUR CRUDE OIL, FLAMMABLE, TOXIC	3	6.1	II	343	1 ℓ	E2	P001	-	IBC02	-	F-E, S-E	Category D. Clear of living quarters.	See entry above.	3494
3494	PETROLEIUM SOUR CRUDE OIL, FLAMMABLE, TOXIC	3	6.1	III	343	5 ℓ	E1	P001	-	IBC03	-	F-E, S-E	Category D. Clear of living quarters.	See entry above.	3494
3495	IODINE	8	6.1	III	279	5 kg	E1	P002	-	IBC08	B3	F-A, S-B	Category B. Clear of living quarters. "Separated from" ammonia.	Bluish-black solid with a metallic lustre and a pungent odour. Melting point: 114°C. Below its melting point, may evolve vapours which are irritating to skin, eye and mucous membranes. Slightly soluble in water but soluble in most organic solvents. Corrosive to most metals.	3495
3496	BATTERIES, NICKEL-METAL HYDRIDE	9	-	-	117 963	0	EO	See SP963	-	-	-	F-A, S-I	Category A. Protected from sources of heat.	Nickel-metal hydride button cells or nickel-metal hydride cells or batteries packed with or contained in equipment are not subject to the provisions of this Code.	3496
3497	KRILL MEAL	4.2	-	II	300	0	E2	P410	-	IBC06	B2	F-A, S-J	Category B. "Separated by a partition" from Class 1.4. For special stowage provisions, see 7.6.2.7.1.	Pink to red meal derived from krill which is a shrimp-like marine crustacean. It may be contaminated with oil. Capable of self-heating. Naturally rich in anti-oxidants, which lessen the risk of spontaneous heating.	3497
3497	KRILL MEAL	4.2	-	III	223	300	0	P002	LP02	IBC08	B3	F-A, S-J	Category A.	See entry above.	3497
3498	IODINE MONOCHLORIDE LIQUID	8	-	II	-	1 ℓ	E2	P001	-	IBC02	-	F-A, S-B	Category D. Clear of living quarters. Segregation as for Class 5.1 but "separated from" classes 4.1, 5.1 and 7.	Red liquid. Reacts violently with water, evolving irritating and corrosive gases apparent as white fumes. Powerful oxidant; may cause fire in contact with organic materials such as wood, cotton or straw. In the presence of water, highly corrosive to most metals. Vapour irritates mucous membranes.	3498
3499	CAPACITOR, electric double layer (with an energy storage capacity greater than 0.3 Wh)	9	-	-	361	0	EO	P003	-	-	-	F-A, S-I	Category A.	Articles intended to store energy containing a non-dangerous activated carbon and an electrolyte. Electric double layer capacitors installed in equipment may be transported in a charged state.	3499
3500	CHEMICAL UNDER PRESSURE, N.O.S.	2.2	-	-	274	362	0	EO	P206	-	-	F-C, S-V	Category B.	Liquids, pastes or powders, pressurized with a propellant which meets the definition of a gas.	3500
3501	CHEMICAL UNDER PRESSURE, FLAMMABLE, N.O.S.	2.1	-	-	274	362	0	EO	P206	PH89	-	F-D, S-V	Category D. Clear of living quarters. See entry above.	See entry above.	3501
3502	CHEMICAL UNDER PRESSURE, TOXIC, N.O.S.	2.2	6.1	-	274	362	0	EO	P206	PH89	-	F-C, S-V	Category D. Clear of living quarters. See entry above.	See entry above.	3502
3503	CHEMICAL UNDER PRESSURE, CORROSIVE, N.O.S.	2.2	8	-	274	362	0	EO	P206	PH89	-	F-C, S-V	Category D. Clear of living quarters. See entry above.	See entry above.	3503



UN No. (1)	PSN (2)	Class of Div (3)	Subsidiary Risk(s) (4)	Packing Group (5)	Special Provisions (6)	Limited quantities (7a)	Excepted quantities (7b)	Packing		IBC		Portable tanks and bulk containers		Ems (15)	Stowage and Segregation (16)	Properties and Observations (17)	UN No. (18)
								Institutions (8)	Provisions (9)	Institutions (10)	Provisions (11)	Tank instructions (12)	Provisons (14)				
	3.1.2	2.0	2.0	2.0, 1.3	3.3	3.4	3.5	4.1, 4	4.1, 4	4.1, 4	4.1, 4	4.2, 5 4.3	4.2, 5	5.4, 3.2 7.8	7.1 to 7.7		
3504 CHEMICAL UNDER PRESSURE, FLAMMABLE, TOXIC, N.O.S. 2.1																	
		6.1	-	274 362	0	ED	P206	P889	-	-	-	T50	TM TP40	E, D, S, L	Category D. Clear of living quarters. See entry above		3504
3505 CHEMICAL UNDER PRESSURE, FLAMMABLE, CORROSIVE, N.O.S.																	
		2.1	8	-	274 362	0	ED	P206	P889	-	-	T50	TM TP40	E, D, S, L	Category D. Clear of living quarters. See entry above		3505
3506 MERCURY CONTAINED IN MANUFACTURED ARTICLES																	
		8	6.1	III	366	5 kg	ED	P003	PP90	-	-	-	-	F-A, S, B	Category B. Clear of living quarters, hazardous and other ships constructed with aluminium. Away from cables.		3506
Total: 2801																	

---

MARITIME SAFETY COMMITTEE  
90th session  
Agenda item 28

MSC 90/28/Add.4  
21 June 2012  
Original: ENGLISH

**REPORT OF THE MARITIME SAFETY COMMITTEE ON ITS  
NINETIETH SESSION**

Attached is the third part of annex 4 (Annex 3, Amendments to the International Maritime Dangerous Goods (IMDG) Code (amendment 36-12), Index) to the report of the Maritime Safety Committee on its ninetieth session (MSC 90/28).

\*\*\*



**ANNEX 4**

**RESOLUTION MSC.328(90) – ADOPTION OF AMENDMENTS TO THE  
INTERNATIONAL MARITIME DANGEROUS GOODS (IMDG) CODE  
(amendment 36-12)**

Annex 3

Index



# Index

---

In this Index, the word "see", after the name in the substance, material or article column, means that it is a synonym and for details regarding the transport provisions reference shall be made to the entry in the Dangerous Goods List (chapter 3.2) which is relevant to the UN Number/Proper Shipping Name stated against the synonym.

## Method of indexing

Substances, materials and articles have been listed in the alphabetical order of their names. For the purpose of determining the alphabetical order, numbers and roman numerals (I), (II) etc. and the prefixes listed below have been disregarded, although they form an integral part of the name:

<i>N-</i>	<i>sym-</i>
<i>n- or normal-</i>	<i>uns-</i>
<i>sec- or secondary-</i>	<i>cis-</i>
<i>tert- or tertiary-</i>	<i>trans-</i>
<i>o- or ortho-</i>	<i>d-</i>
<i>m- or meta-</i>	<i>α- or alpha-</i>
<i>p- or para-</i>	<i>β- or beta-</i>
	<i>γ- or gamma-</i>

## Note 1

Certain marine pollutants are identified only in the Index. These marine pollutants have not been assigned to an N.O.S. or generic entry. These marine pollutants may possess properties of classes 1 to 8 and should be classified accordingly. A substance which does not fall within the criteria of these classes should be offered for transport as an ENVIRONMENTALLY HAZARDOUS SUBSTANCE, SOLID, N.O.S., UN 3077, or as an ENVIRONMENTALLY HAZARDOUS SUBSTANCE, LIQUID, N.O.S., UN 3082, under these entries in class 9.



Substance, material or article	MP	Class	UN No.
ACETAL	–	3	1088
ACETALDEHYDE	–	3	1089
ACETALDEHYDE AMMONIA	–	9	1841
Acetaldehyde diethyl acetal, <i>see</i>	–	3	1088
ACETALDEHYDE OXIME	–	3	2332
Acetaldol, <i>see</i>	–	6.1	2839
<i>beta</i> -Acetaldoxime, <i>see</i>	–	3	2332
ACETIC ACID, GLACIAL	–	8	2789
ACETIC ACID SOLUTION more than 10% and less than 50% acid, by mass	–	8	2790
ACETIC ACID SOLUTION not less than 50% but no more than 80% acid, by mass	–	8	2790
ACETIC ACID SOLUTION more than 80% acid, by mass	–	8	2789
Acetic aldehyde, <i>see</i>	–	3	1089
ACETIC ANHYDRIDE	–	8	1715
Acetic oxide, <i>see</i>	–	8	1715
Acetoin, <i>see</i>	–	3	2621
ACETONE	–	3	1090
ACETONE CYANOHYDRIN, STABILIZED	P	6.1	1541
Acetone hexafluoride, <i>see</i>	–	2.3	2420
ACETONE OILS	–	3	1091
Acetone–pyrogallol copolymer 2-diazo-1-naphthol-5-sulphonate	–	4.1	3228
ACETONE SOLUTIONS	–	3	1090
ACETONITRILE	–	3	1648
3-Acetoxypropene, <i>see</i>	–	3	2333
Acetylacetone, <i>see</i>	–	3	2310
Acetyl acetone peroxide (concentration ≤32%, as a paste), <i>see</i>	–	5.2	3106
Acetyl acetone peroxide (concentration ≤42%, with diluent Type A, and water, available oxygen ≤4.7%), <i>see</i>	–	5.2	3105
ACETYL BROMIDE	–	8	1716
ACETYL CHLORIDE	–	3	1717
Acetyl cyclohexanesulphonyl peroxide (concentration ≤32%, with diluent Type B), <i>see</i>	–	5.2	3115
Acetyl cyclohexanesulphonyl peroxide (concentration ≤82%, with water), <i>see</i>	–	5.2	3112
Acetylene dichloride, <i>see</i>	–	3	1150
ACETYLENE, DISSOLVED	–	2.1	1001
Acetylene, ethylene and propylene mixtures, refrigerated liquid, <i>see</i>	–	2.1	3138
ACETYLENE, SOLVENT FREE	–	2.1	3374
Acetylene tetrabromide, <i>see</i>	P	6.1	2504
Acetylene tetrachloride, <i>see</i>	P	6.1	1702
ACETYL IODIDE	–	8	1898
Acetyl ketene, stabilized, <i>see</i>	–	6.1	2521
ACETYL METHYL CARBINOL	–	3	2621
Acid butyl phosphate, <i>see</i>	–	8	1718



Index

Substance, material or article	MP	Class	UN No.
Acid mixture, hydrofluoric and sulphuric, <i>see</i>	–	8	1786
Acid mixture, nitrating acid, <i>see</i>	–	8	1796
Acid mixture, spent, nitrating acid, <i>see</i>	–	8	1826
Acraldehyde, stabilized, <i>see</i>	P	6.1	1092
ACRIDINE	–	6.1	2713
Acroleic acid, stabilized, <i>see</i>	–	8	2218
Acrolein diethyl acetal, <i>see</i>	–	3	2374
ACROLEIN DIMER, STABILIZED	–	3	2607
ACROLEIN, STABILIZED	P	6.1	1092
ACRYLAMIDE, SOLID	–	6.1	2074
ACRYLAMIDE SOLUTION	–	6.1	3426
Acrylic acid isobutyl ester, stabilized, <i>see</i>	–	3	2527
ACRYLIC ACID, STABILIZED	–	8	2218
Acrylic aldehyde, stabilized, <i>see</i>	P	6.1	1092
ACRYLONITRILE, STABILIZED	–	3	1093
Actinolite, <i>see</i>	–	9	2590
Activated carbon, <i>see</i>	–	4.2	1362
Activated charcoal, <i>see</i>	–	4.2	1362
ADHESIVES containing flammable liquid	–	3	1133
ADIPONITRILE	–	6.1	2205
Aeroplane flares, <i>see</i> FLARES, AERIAL	–	–	–
AEROSOLS	–	2	1950
AGENT, BLASTING, TYPE B	–	1.5D	0331
AGENT, BLASTING, TYPE E	–	1.5D	0332
AIR BAG INFLATORS	–	1.4G	0503
AIR BAG INFLATORS	–	9	3268
AIR BAG MODULES	–	1.4G	0503
AIR BAG MODULES	–	9	3268
AIR, COMPRESSED	–	2.2	1002
AIRCRAFT HYDRAULIC POWER UNIT FUEL TANK (containing a mixture of anhydrous hydrazine and methylhydrazine)	–	3	3165
AIR, REFRIGERATED LIQUID	–	2.2	1003
ALCOHOLATES SOLUTION, N.O.S. in alcohol	–	3	3274
Alcohol C <sub>12</sub> –C <sub>16</sub> poly(1–6)ethoxylate, <i>see</i>	P	9	3082
Alcohol C <sub>6</sub> –C <sub>17</sub> (secondary) poly(3–6)ethoxylate, <i>see</i>	P	9	3082
ALCOHOLIC BEVERAGES, with more than 24% but not more than 70% alcohol by volume	–	3	3065
ALCOHOLIC BEVERAGES, with more than 70% alcohol by volume	–	3	3065
ALCOHOLS, FLAMMABLE, TOXIC, N.O.S.	–	3	1986
ALCOHOLS, N.O.S.	–	3	1987
ALDEHYDES, FLAMMABLE, TOXIC, N.O.S.	–	3	1988
ALDEHYDES, N.O.S.	–	3	1989
Aldicarb, <i>see</i> CARBAMATE PESTICIDE	P	–	–
ALDOL	–	6.1	2839

Substance, material or article	MP	Class	UN No.
Aldrin, <i>see</i> ORGANOCHLORINE PESTICIDE	P	–	–
ALKALI METAL ALCOHOLATES, SELF-HEATING, CORROSIVE, N.O.S.	–	4.2	3206
ALKALI METAL ALLOY, LIQUID, N.O.S.	–	4.3	1421
ALKALI METAL AMALGAM, LIQUID	–	4.3	1389
ALKALI METAL AMALGAM, SOLID	–	4.3	3401
ALKALI METAL AMIDE	–	4.3	1390
ALKALI METAL DISPERSION	–	4.3	1391
ALKALI METAL DISPERSION, FLAMMABLE	–	4.3	3482
Alkaline caustic liquid, N.O.S., <i>see</i>	–	8	1719
ALKALINE EARTH METAL ALCOHOLATES, N.O.S.	–	4.2	3205
ALKALINE EARTH METAL ALLOY, N.O.S.	–	4.3	1393
ALKALINE EARTH METAL AMALGAM, LIQUID	–	4.3	1392
ALKALINE EARTH METAL AMALGAM, SOLID	–	4.3	3402
ALKALINE EARTH METAL DISPERSION	–	4.3	1391
ALKALINE EARTH METAL DISPERSION, FLAMMABLE	–	4.3	3482
ALKALOIDS, LIQUID, N.O.S.	–	6.1	3140
ALKALOIDS SALTS, LIQUID, N.O.S.	–	6.1	3140
ALKALOIDS SALTS, SOLID, N.O.S.	–	6.1	1544
ALKALOIDS, SOLID, N.O.S.	–	6.1	1544
Alkyl benzenesulphonates, branched and straight-chain (excluding C <sub>11</sub> –C <sub>13</sub> branched and straight-chain homologues), <i>see</i>	P	9	3082
Alkyl(C <sub>12</sub> –C <sub>14</sub> )dimethylamine, <i>see</i> Note 1	P	–	–
Alkyl (C <sub>7</sub> –C <sub>9</sub> ) nitrates, <i>see</i> Note 1	P	–	–
ALKYLPHENOLS, LIQUID, N.O.S. (including C <sub>2</sub> –C <sub>12</sub> homologues)	–	8	3145
ALKYLPHENOLS, SOLID, N.O.S. (including C <sub>2</sub> –C <sub>12</sub> homologues)	–	8	2430
ALKYLSULPHONIC ACIDS, LIQUID with more than 5% free sulphuric acid	–	8	2584
ALKYLSULPHONIC ACIDS, LIQUID with not more than 5% free sulphuric acid	–	8	2586
ALKYLSULPHONIC ACIDS, SOLID with more than 5% free sulphuric acid	–	8	2583
ALKYLSULPHONIC ACIDS, SOLID with not more than 5% free sulphuric acid	–	8	2585
ALKYLSULPHURIC ACIDS	–	8	2571
Allene, stabilized, <i>see</i>	–	2.1	2200
ALLYL ACETATE	–	3	2333
ALLYL ALCOHOL	–	6.1	1098
ALLYLAMINE	–	6.1	2334
ALLYL BROMIDE	P	3	1099
ALLYL CHLORIDE	–	3	1100
Allyl chlorocarbonate, <i>see</i>	–	6.1	1722
ALLYL CHLOROFORMATE	–	6.1	1722
ALLYL ETHYL ETHER	–	3	2335
ALLYL FORMATE	–	3	2336
ALLYL GLYCIDYL ETHER	–	3	2219

Index

Substance, material or article	MP	Class	UN No.
ALLYL IODIDE	–	3	1723
ALLYL ISOTHIOCYANATE, STABILIZED	–	6.1	1545
Allyl mustard oil, stabilized, <i>see</i>	–	6.1	1545
ALLYLTRICHLOROSILANE, STABILIZED	–	8	1724
Aluminium alkyls, <i>see</i>	–	4.2	3394
Aluminium alkyl halides, liquid, <i>see</i>	–	4.2	3394
Aluminium alkyl halides, solid, <i>see</i>	–	4.2	3393
Aluminium alkyl hydrides, <i>see</i>	–	4.2	3394
ALUMINIUM BOROHYDRIDE	–	4.2	2870
ALUMINIUM BOROHYDRIDE IN DEVICES	–	4.2	2870
ALUMINIUM BROMIDE, ANHYDROUS	–	8	1725
ALUMINIUM BROMIDE SOLUTION	–	8	2580
ALUMINIUM CARBIDE	–	4.3	1394
ALUMINIUM CHLORIDE, ANHYDROUS	–	8	1726
ALUMINIUM CHLORIDE SOLUTION	–	8	2581
Aluminium dross, <i>see</i>	–	4.3	3170
ALUMINIUM FERROSILICON POWDER	–	4.3	1395
ALUMINIUM HYDRIDE	–	4.3	2463
ALUMINIUM NITRATE	–	5.1	1438
ALUMINIUM PHOSPHIDE	–	4.3	1397
ALUMINIUM PHOSPHIDE PESTICIDE	–	6.1	3048
ALUMINIUM POWDER, COATED	–	4.1	1309
Aluminium powder, pyrophoric, <i>see</i>	–	4.2	1383
ALUMINIUM POWDER, UNCOATED	–	4.3	1396
ALUMINIUM REMELTING BY-PRODUCTS	–	4.3	3170
Aluminium residues, <i>see</i>	–	4.3	3170
ALUMINIUM RESINATE	–	4.1	2715
ALUMINIUM SILICON POWDER, UNCOATED	–	4.3	1398
Aluminium skimmings, <i>see</i>	–	4.3	3170
ALUMINIUM SMELTING BY-PRODUCTS	–	4.3	3170
Amatols, <i>see</i> EXPLOSIVE, BLASTING, TYPE B	–	–	–
AMINES, FLAMMABLE, CORROSIVE, N.O.S.	–	3	2733
AMINES, LIQUID, CORROSIVE, FLAMMABLE, N.O.S.	–	8	2734
AMINES, LIQUID, CORROSIVE, N.O.S.	–	8	2735
AMINES, SOLID, CORROSIVE, N.O.S.	–	8	3259
1-Amino-3-aminomethyl-3,5,5-trimethylcyclohexane, <i>see</i>	–	8	2289
<i>ortho</i> -Aminoanisole, <i>see</i>	–	6.1	2431
Aminobenzene, <i>see</i>	–	6.1	1547
2-Aminobenzotrifluoride, <i>see</i>	–	6.1	2942
3-Aminobenzotrifluoride, <i>see</i>	–	6.1	2948
1-Aminobutane, <i>see</i>	–	3	1125
Aminocarb, <i>see</i> CARBAMATE PESTICIDE	P	–	–
2-AMINO-4-CHLOROPHENOL	–	6.1	2673

Substance, material or article	MP	Class	UN No.
Aminocyclohexane, <i>see</i>	–	8	2357
2-AMINO-5-DIETHYLAMINOPENTANE	–	6.1	2946
Aminodimethylbenzenes, liquid, <i>see</i>	–	6.1	1711
Aminodimethylbenzenes, solid, <i>see</i>	–	6.1	3452
2-AMINO-4,6-DINITROPHENOL, WETTED with not less than 20% water by mass	–	4.1	3317
Aminoethane, <i>see</i>	–	2.1	1036
Aminoethane, aqueous solution, <i>see</i>	–	3	2270
1-Aminoethanol, <i>see</i>	–	9	1841
2-Aminoethanol, <i>see</i>	–	8	2491
2-(2-AMINOETHOXY)ETHANOL	–	8	3055
N-AMINOETHYLPIPERAZINE	–	8	2815
Aminomethane, anhydrous, <i>see</i>	–	2.1	1061
Aminomethane, aqueous solution, <i>see</i>	–	3	1235
1-Amino-2-methylpropane, <i>see</i>	–	3	1214
3-Aminomethyl-3,5,5-trimethylcyclohexylamine, <i>see</i>	–	8	2289
1-Amino-2-nitrobenzene, <i>see</i>	–	6.1	1661
1-Amino-3-nitrobenzene, <i>see</i>	–	6.1	1661
1-Amino-4-nitrobenzene, <i>see</i>	–	6.1	1661
Aminophenetholes, <i>see</i>	–	6.1	2311
AMINOPHENOLS ( <i>o</i> -, <i>m</i> -, <i>p</i> -)	–	6.1	2512
1-Aminopropane, <i>see</i>	–	3	1277
2-Aminopropane, <i>see</i>	–	3	1221
3-Aminopropene, <i>see</i>	–	6.1	2334
AMINOPYRIDINES ( <i>o</i> -, <i>m</i> -, <i>p</i> -)	–	6.1	2671
Aminosulphonic acid, <i>see</i>	–	8	2967
AMMONIA, ANHYDROUS	–	2.3	1005
AMMONIA SOLUTION relative density between 0.880 and 0.957 at 15°C in water, with more than 10% but not more than 35% ammonia, by mass	–	8	2672
AMMONIA SOLUTION relative density less than 0.880 at 15°C in water, with more than 35% but not more than 50% ammonia	–	2.2	2073
AMMONIA SOLUTION relative density less than 0.880 at 15°C in water, with more than 50% ammonia	–	2.3	3318
Ammonium acid fluoride, solid, <i>see</i>	–	8	1727
Ammonium acid fluoride solution, <i>see</i>	–	8	2817
AMMONIUM ARSENATE	–	6.1	1546
Ammonium bichromate, <i>see</i>	–	5.1	1439
Ammonium bifluoride, solid, <i>see</i>	–	8	1727
Ammonium bifluoride solution, <i>see</i>	–	8	2817
Ammonium bisulphate, <i>see</i>	–	8	2506
Ammonium bisulphite solution, <i>see</i>	–	8	2693
Ammonium bromate (transport prohibited)	–	–	–
Ammonium bromate solution (transport prohibited)	–	–	–
Ammonium chlorate (transport prohibited)	–	–	–

Index

Substance, material or article	MP	Class	UN No.
Ammonium chlorate solution (transport prohibited)	–	–	–
Ammonium chlorite (transport prohibited)	–	–	–
AMMONIUM DICROMATE	–	5.1	1439
AMMONIUM DINITRO- <i>o</i> -CRESOLATE, SOLID	P	6.1	1843
AMMONIUM DINITRO- <i>o</i> -CRESOLATE SOLUTION	P	6.1	3424
AMMONIUM FLUORIDE	–	6.1	2505
AMMONIUM FLUOROSILICATE	–	6.1	2854
Ammonium hexafluorosilicate, <i>see</i>	–	6.1	2854
AMMONIUM HYDROGENDIFLUORIDE, SOLID	–	8	1727
AMMONIUM HYDROGENDIFLUORIDE SOLUTION	–	8	2817
AMMONIUM HYDROGEN SULPHATE	–	8	2506
Ammonium hypochlorite (transport prohibited)	–	–	–
AMMONIUM METAVANADATE	–	6.1	2859
AMMONIUM NITRATE BASED FERTILIZER	–	5.1	2067
AMMONIUM NITRATE BASED FERTILIZER	–	9	2071
AMMONIUM NITRATE EMULSION intermediate for blasting explosives	–	5.1	3375
AMMONIUM NITRATE GEL intermediate for blasting explosives	–	5.1	3375
AMMONIUM NITRATE liable to self-heating sufficient to initiate decomposition (transport prohibited)	–	–	–
AMMONIUM NITRATE, LIQUID (hot concentrated solution)	–	5.1	2426
AMMONIUM NITRATE SUSPENSION intermediate for blasting explosives	–	5.1	3375
AMMONIUM NITRATE with more than 0.2% combustible substances, including any organic substance calculated as carbon to the exclusion of any other added substance	–	1.1D	0222
AMMONIUM NITRATE with not more than 0.2% total combustible material, including any organic substance calculated as carbon to the exclusion of any other added substance	–	5.1	1942
Ammonium nitrite (transport prohibited)	–	–	–
AMMONIUM PERCHLORATE	–	1.1D	0402
AMMONIUM PERCHLORATE	–	5.1	1442
Ammonium permanganate (transport prohibited)	–	–	–
Ammonium permanganate solution (transport prohibited)	–	–	–
AMMONIUM PERSULPHATE	–	5.1	1444
AMMONIUM PICRATE dry or wetted with less than 10% water, by mass	–	1.1D	0004
AMMONIUM PICRATE, WETTED with not less than 10% water, by mass	–	4.1	1310
AMMONIUM POLYSULPHIDE SOLUTION	–	8	2818
AMMONIUM POLYVANADATE	–	6.1	2861
Ammonium silicofluoride, <i>see</i>	–	6.1	2854
AMMONIUM SULPHIDE SOLUTION	–	8	2683
Ammonium vanadate, <i>see</i>	–	6.1	2859
Ammunition, blank, <i>see</i> CARTRIDGES FOR WEAPONS, BLANK	–	–	–
Ammunition, fixed, semi-fixed or separate loading, <i>see</i> CARTRIDGES FOR WEAPONS, with bursting charge	–	–	–

Substance, material or article	MP	Class	UN No.
AMMUNITION, ILLUMINATING with or without burster, expelling charge or propelling charge	–	1.2G	0171
AMMUNITION, ILLUMINATING with or without burster, expelling charge or propelling charge	–	1.3G	0254
AMMUNITION, ILLUMINATING with or without burster, expelling charge or propelling charge	–	1.4G	0297
AMMUNITION, INCENDIARY liquid or gel, with burster, expelling charge or propelling charge	–	1.3J	0247
Ammunition, incendiary (water-activated contrivances) with burster, expelling charge or propelling charge, <i>see</i> CONTRIVANCES, WATER-ACTIVATED	–	–	–
AMMUNITION, INCENDIARY, WHITE PHOSPHORUS with burster, expelling charge or propelling charge	–	1.2H	0243
AMMUNITION, INCENDIARY, WHITE PHOSPHORUS with burster, expelling charge or propelling charge	–	1.3H	0244
AMMUNITION, INCENDIARY with or without burster, expelling charge or propelling charge	–	1.2G	0009
AMMUNITION, INCENDIARY with or without burster, expelling charge or propelling charge	–	1.3G	0010
AMMUNITION, INCENDIARY with or without burster, expelling charge or propelling charge	–	1.4G	0300
Ammunition, industrial, <i>see</i> CARTRIDGES, OIL WELL <i>and</i> CARTRIDGES, POWER DEVICE	–	–	–
Ammunition, lachrymatory, <i>see</i> AMMUNITION, TEAR-PRODUCING	–	–	–
AMMUNITION, PRACTICE	–	1.3G	0488
AMMUNITION, PRACTICE	–	1.4G	0362
AMMUNITION, PROOF	–	1.4G	0363
Ammunition, smoke (water-activated contrivances), <i>see</i> CONTRIVANCES, WATER-ACTIVATED	–	–	–
AMMUNITION, SMOKE, WHITE PHOSPHORUS with burster, expelling charge or propelling charge	–	1.2H	0245
AMMUNITION, SMOKE, WHITE PHOSPHORUS with burster, expelling charge or propelling charge	–	1.3H	0246
AMMUNITION, SMOKE with or without burster, expelling charge or propelling charge	–	1.2G	0015
AMMUNITION, SMOKE with or without burster, expelling charge or propelling charge	–	1.3G	0016
AMMUNITION, SMOKE with or without burster, expelling charge or propelling charge	–	1.4G	0303
Ammunition, sporting, <i>see</i> CARTRIDGES FOR WEAPONS, INERT PROJECTILE	–	–	–
AMMUNITION, TEAR-PRODUCING, NON-EXPLOSIVE without burster or expelling charge, non-fuzed	–	6.1	2017
AMMUNITION, TEAR-PRODUCING with burster, expelling charge or propelling charge	–	1.2G	0018
AMMUNITION, TEAR-PRODUCING with burster, expelling charge or propelling charge	–	1.3G	0019
AMMUNITION, TEAR-PRODUCING with burster, expelling charge or propelling charge	–	1.4G	0301
AMMUNITION, TOXIC, NON-EXPLOSIVE without burster or expelling charge, non-fuzed	–	6.1	2016

Index

Substance, material or article	MP	Class	UN No.
AMMUNITION, TOXIC with burster, expelling charge or propelling charge	–	1.2K	0020
AMMUNITION, TOXIC with burster, expelling charge or propelling charge	–	1.3K	0021
Amorces, <i>see</i> FIREWORKS	–	–	–
Amosite, <i>see</i>	–	9	2212
AMYL ACETATES	–	3	1104
AMYL ACID PHOSPHATE	–	8	2819
Amyl alcohols, <i>see</i>	–	3	1105
Amyl aldehyde, <i>see</i>	–	3	2058
AMYLAMINE	–	3	1106
<i>n</i> -Amylbenzene, <i>see</i> Note 1	P	–	–
<i>secondary</i> -Amyl bromide, <i>see</i>	–	3	2343
AMYL BUTYRATES	–	3	2620
Amyl carbinol, <i>see</i>	–	3	2282
AMYL CHLORIDE	–	3	1107
<i>n</i> -AMYLENE	–	3	1108
AMYL FORMATES	–	3	1109
<i>tert</i> -Amyl hydroperoxide (concentration $\leq 88\%$ , with diluent Type A and water), <i>see</i>	–	5.2	3107
<i>normal</i> -Amyl mercaptan, <i>see</i>	–	3	1111
AMYL MERCAPTAN	–	3	1111
<i>n</i> -AMYL METHYL KETONE	–	3	1110
AMYL NITRATE	–	3	1112
AMYL NITRITE	–	3	1113
<i>normal</i> -Amyl nitrite, <i>see</i>	–	3	1113
<i>tert</i> -Amyl peroxy-2-ethylhexanoate (concentration $\leq 100\%$ ), <i>see</i>	–	5.2	3115
<i>tert</i> -Amyl peroxy-2-ethylhexyl carbonate (concentration $\leq 100\%$ ), <i>see</i>	–	5.2	3105
<i>tert</i> -Amyl peroxy-3,5,5-trimethylhexanoate (concentration $\leq 100\%$ ), <i>see</i>	–	5.2	3105
<i>tert</i> -Amyl peroxyacetate (concentration $\leq 62\%$ , with diluent Type A), <i>see</i>	–	5.2	3105
<i>tert</i> -Amyl peroxybenzoate (concentration $\leq 100\%$ ), <i>see</i>	–	5.2	3103
<i>tert</i> -Amyl peroxyisopropyl carbonate (concentration $\leq 77\%$ , with diluent Type A), <i>see</i>	–	5.2	3103
<i>tert</i> -Amyl peroxyneodecanoate (concentration $\leq 47\%$ , with diluent Type A) <i>see</i>	–	5.2	3119
<i>tert</i> -Amyl peroxyneodecanoate (concentration $\leq 77\%$ , with diluent Type B), <i>see</i>	–	5.2	3115
<i>tert</i> -Amyl peroxy-pivalate (concentration $\leq 77\%$ , with diluent Type B), <i>see</i>	–	5.2	3113
AMYLTRICHLOROSILANE	–	8	1728
ANILINE	–	6.1	1547
Aniline chloride, <i>see</i>	–	6.1	1548
ANILINE HYDROCHLORIDE	–	6.1	1548
Aniline oil, <i>see</i>	–	6.1	1547
Aniline salt, <i>see</i>	–	6.1	1548

Substance, material or article	MP	Class	UN No.
Animal fabrics, oily, <i>see</i>	–	4.2	1373
Animal fibres, burnt, <i>see</i>	–	4.2	1372
Animal fibres, damp, <i>see</i>	–	4.2	1372
Animal fibres, oily, <i>see</i>	–	4.2	1373
Animal fibres, wet, <i>see</i>	–	4.2	1372
<i>ortho</i> -ANISIDINE	–	6.1	2431
ANISOLE	–	3	2222
ANISOYL CHLORIDE	–	8	1729
Anthophyllite, <i>see</i>	–	9	2590
ANTIMONY CHLORIDE	–	8	1733
Antimony chloride, solid, <i>see</i>	–	8	1733
ANTIMONY COMPOUND, INORGANIC, LIQUID, N.O.S.	–	6.1	3141
ANTIMONY COMPOUND, INORGANIC, SOLID, N.O.S.	–	6.1	1549
Antimony hydride, <i>see</i>	–	2.3	2676
ANTIMONY LACTATE	–	6.1	1550
Antimony(III) lactate, <i>see</i>	–	6.1	1550
ANTIMONY PENTACHLORIDE, LIQUID	–	8	1730
ANTIMONY PENTACHLORIDE SOLUTION	–	8	1731
ANTIMONY PENTAFLUORIDE	–	8	1732
Antimony perchloride, liquid, <i>see</i>	–	8	1730
Antimony perchloride solution, <i>see</i>	–	8	1731
ANTIMONY POTASSIUM TARTRATE	–	6.1	1551
ANTIMONY POWDER	–	6.1	2871
ANTIMONY TRICHLORIDE	–	8	1733
Antimony trihydride, <i>see</i>	–	2.3	2676
A.n.t.u, <i>see also</i> PESTICIDE, N.O.S.	–	6.1	1651
Aqua regia, <i>see</i>	–	8	1798
ARGON, COMPRESSED	–	2.2	1006
ARGON, REFRIGERATED LIQUID	–	2.2	1951
Arsenates, liquid, N.O.S., inorganic, <i>see</i>	–	6.1	1556
Arsenates, solid, N.O.S., inorganic, <i>see</i>	–	6.1	1557
ARSENIC	–	6.1	1558
ARSENIC ACID, LIQUID	–	6.1	1553
ARSENIC ACID, SOLID	–	6.1	1554
ARSENICAL DUST	–	6.1	1562
Arsenical flue dust, <i>see</i>	–	6.1	1562
ARSENICAL PESTICIDE, LIQUID, FLAMMABLE, TOXIC, flashpoint less than 23°C	–	3	2760
ARSENICAL PESTICIDE, LIQUID, TOXIC	–	6.1	2994
ARSENICAL PESTICIDE, LIQUID, TOXIC, FLAMMABLE, flashpoint not less than 23°C	–	6.1	2993
ARSENICAL PESTICIDE, SOLID, TOXIC	–	6.1	2759
ARSENIC BROMIDE	–	6.1	1555
Arsenic(III) bromide, <i>see</i>	–	6.1	1555



Index

Substance, material or article	MP	Class	UN No.
Arsenic chloride, <i>see</i>	–	6.1	1560
ARSENIC COMPOUND, LIQUID, N.O.S. inorganic, including: Arsenates, n.o.s., Arsenites, n.o.s., and Arsenic sulphides, n.o.s.	–	6.1	1556
ARSENIC COMPOUND, SOLID, N.O.S. inorganic, including: Arsenates, n.o.s.; Arsenites, n.o.s.; and Arsenic sulphides, n.o.s.	–	6.1	1557
Arsenic compounds (pesticides), <i>see</i> ARSENICAL PESTICIDE	–	–	–
Arsenic hydride, <i>see</i>	–	2.3	2188
Arsenic(III) oxide, <i>see</i>	–	6.1	1561
Arsenic(V) oxide, <i>see</i>	–	6.1	1559
ARSENIC PENTOXIDE	–	6.1	1559
Arsenic sulphides, liquid, N.O.S., inorganic, <i>see</i>	–	6.1	1556
Arsenic sulphides, solid, N.O.S., inorganic, <i>see</i>	–	6.1	1557
Arsenic tribromide, <i>see</i>	–	6.1	1555
ARSENIC TRICHLORIDE	–	6.1	1560
ARSENIC TRIOXIDE	–	6.1	1561
Arsenious chloride, <i>see</i>	–	6.1	1560
Arsenites, liquid, N.O.S., inorganic, <i>see</i>	–	6.1	1556
Arsenites, solid, N.O.S., inorganic, <i>see</i>	–	6.1	1557
Arsenous bromide, <i>see</i>	–	6.1	1555
Arsenous chloride, <i>see</i>	–	6.1	1560
ARSINE	–	2.3	2188
ARTICLES, EEI	–	1.6N	0486
ARTICLES, EXPLOSIVE, EXTREMELY INSENSITIVE	–	1.6N	0486
ARTICLES, EXPLOSIVE, N.O.S.	–	1.1C	0462
ARTICLES, EXPLOSIVE, N.O.S.	–	1.1D	0463
ARTICLES, EXPLOSIVE, N.O.S.	–	1.1E	0464
ARTICLES, EXPLOSIVE, N.O.S.	–	1.1F	0465
ARTICLES, EXPLOSIVE, N.O.S.	–	1.1L	0354
ARTICLES, EXPLOSIVE, N.O.S.	–	1.2C	0466
ARTICLES, EXPLOSIVE, N.O.S.	–	1.2D	0467
ARTICLES, EXPLOSIVE, N.O.S.	–	1.2E	0468
ARTICLES, EXPLOSIVE, N.O.S.	–	1.2F	0469
ARTICLES, EXPLOSIVE, N.O.S.	–	1.2L	0355
ARTICLES, EXPLOSIVE, N.O.S.	–	1.3C	0470
ARTICLES, EXPLOSIVE, N.O.S.	–	1.3L	0356
ARTICLES, EXPLOSIVE, N.O.S.	–	1.4B	0350
ARTICLES, EXPLOSIVE, N.O.S.	–	1.4C	0351
ARTICLES, EXPLOSIVE, N.O.S.	–	1.4D	0352
ARTICLES, EXPLOSIVE, N.O.S.	–	1.4E	0471
ARTICLES, EXPLOSIVE, N.O.S.	–	1.4F	0472
ARTICLES, EXPLOSIVE, N.O.S.	–	1.4G	0353
ARTICLES, EXPLOSIVE, N.O.S.	–	1.4S	0349
ARTICLES, PRESSURIZED, HYDRAULIC (containing non-flammable gas)	–	2.2	3164

Substance, material or article	MP	Class	UN No.
ARTICLES, PRESSURIZED, PNEUMATIC (containing non-flammable gas)	–	2.2	3164
ARTICLES, PYROPHORIC	–	1.2L	0380
ARTICLES, PYROTECHNIC for technical purposes	–	1.1G	0428
ARTICLES, PYROTECHNIC for technical purposes	–	1.2G	0429
ARTICLES, PYROTECHNIC for technical purposes	–	1.3G	0430
ARTICLES, PYROTECHNIC for technical purposes	–	1.4G	0431
ARTICLES, PYROTECHNIC for technical purposes	–	1.4S	0432
ARYLSULPHONIC ACIDS, LIQUID with more than 5% free sulphuric acid	–	8	2584
ARYLSULPHONIC ACIDS, LIQUID with not more than 5% free sulphuric acid	–	8	2586
ARYLSULPHONIC ACIDS, SOLID with more than 5% free sulphuric acid	–	8	2583
ARYLSULPHONIC ACIDS, SOLID with not more than 5% free sulphuric acid	–	8	2585
Asbestos, <i>see</i> BLUE ASBESTOS	–	9	2212
Asbestos, <i>see</i> BROWN ASBESTOS	–	9	2212
Asbestos, <i>see</i> WHITE ASBESTOS	–	9	2590
Asphalt, <i>see</i>	–	3	1999
AVIATION REGULATED LIQUID, N.O.S.	–	9	3334
AVIATION REGULATED SOLID, N.O.S.	–	9	3335
Azinphos-ethyl, <i>see</i> ORGANOPHOSPHORUS PESTICIDE	P	–	–
Azinphos-methyl, <i>see</i> ORGANOPHOSPHORUS PESTICIDE	P	–	–
Aziridine, stabilized, <i>see</i>	–	6.1	1185
AZODICARBONAMIDE	–	4.1	3242
Azodicarbonamide formulation Type B (concentration <100%, temperature controlled), <i>see</i>	–	4.1	3232
Azodicarbonamide formulation Type C (concentration <100%), <i>see</i>	–	4.1	3224
Azodicarbonamide formulation Type C (concentration <100%, temperature controlled), <i>see</i>	–	4.1	3234
Azodicarbonamide formulation Type D (concentration <100%), <i>see</i>	–	4.1	3226
Azodicarbonamide formulation Type D (concentration <100%, temperature controlled), <i>see</i>	–	4.1	3236
2,2'-Azodi(2,4-dimethyl-4-methoxyvaleronitrile) (concentration 100%), <i>see</i>	–	4.1	3236
2,2'-Azodi(2,4-dimethylvaleronitrile) (concentration 100%), <i>see</i>	–	4.1	3236
2,2'-Azodi(ethyl 2-methylpropionate) (concentration 100%), <i>see</i>	–	4.1	3235
1,1'-Azodi(hexahydrobenzoxonitrile) (concentration 100%), <i>see</i>	–	4.1	3226
2,2'-Azodi(isobutyronitrile), as a water-based paste (concentration ≤50%), <i>see</i>	–	4.1	3224
2,2'-Azodi(isobutyronitrile) (concentration 100%), <i>see</i>	–	4.1	3234
2,2'-Azodi(2-methylbutyronitrile) (concentration 100%), <i>see</i>	–	4.1	3236
Bag charges, <i>see</i> CHARGES, PROPELLING, FOR CANNON	–	–	–
Ballistite, <i>see</i> POWDER, SMOKELESS	–	–	–

Index

Substance, material or article	MP	Class	UN No.
Bangalore torpedoes, see MINES, WITH BURSTING CHARGE	–	–	–
BARIUM	–	4.3	1400
Barium alloys, non-pyrophoric, see	–	4.3	1393
BARIUM ALLOYS, PYROPHORIC	–	4.2	1854
Barium amalgams, liquid, see	–	4.3	1392
Barium amalgams, solid, see	–	4.3	3402
BARIUM AZIDE, dry or wetted with less than 50% water, by mass	–	1.1A	0224
BARIUM AZIDE, WETTED with not less than 50% water, by mass	–	4.1	1571
BARIUM BROMATE	–	5.1	2719
BARIUM CHLORATE, SOLID	–	5.1	1445
BARIUM CHLORATE SOLUTION	–	5.1	3405
BARIUM COMPOUND, N.O.S.	–	6.1	1564
BARIUM CYANIDE	P	6.1	1565
Barium dispersions, see	–	4.3	1391
BARIUM HYPOCHLORITE with more than 22% available chlorine	–	5.1	2741
Barium monoxide, see	–	6.1	1884
BARIUM NITRATE	–	5.1	1446
BARIUM OXIDE	–	6.1	1884
BARIUM PERCHLORATE, SOLID	–	5.1	1447
BARIUM PERCHLORATE SOLUTION	–	5.1	3406
BARIUM PERMANGANATE	–	5.1	1448
BARIUM PEROXIDE	–	5.1	1449
Barium powder, pyrophoric, see	–	4.2	1383
Batteries, containing lithium, see	–	9	3090
BATTERIES, CONTAINING SODIUM	–	4.3	3292
BATTERIES, DRY, CONTAINING POTASSIUM HYDROXIDE, SOLID electric storage	–	8	3028
BATTERIES, NICKEL-METAL HYDRIDE	–	9	3496
BATTERIES, WET, FILLED WITH ACID electric storage	–	8	2794
BATTERIES, WET, FILLED WITH ALKALI electric storage	–	8	2795
BATTERIES, WET, NON-SPILLABLE electric storage	–	8	2800
Battery acid, see	–	8	2796
BATTERY FLUID, ACID	–	8	2796
BATTERY FLUID, ALKALI	–	8	2797
Battery, lithium, see	–	9	3090
BATTERY-POWERED EQUIPMENT	–	9	3171
BATTERY-POWERED VEHICLE	–	9	3171
Bendiocarb, see CARBAMATE PESTICIDE	P	–	–
Benfuracarb, see CARBAMATE PESTICIDE	–	–	–
Benomyl, see Note 1	P	–	–
Benquinox, see PESTICIDE, N.O.S.	P	–	–
Benzal chloride, see	–	6.1	1886
BENZALDEHYDE	–	9	1990

Substance, material or article	MP	Class	UN No.
BENZENE	–	3	1114
1,3-Benzenediol, <i>see</i>	–	6.1	2876
Benzene-1,3-disulphonyl hydrazide, as a paste (concentration 52%), <i>see</i>	–	4.1	3226
Benzene phosphorus dichloride, <i>see</i>	–	8	2798
Benzene phosphorus thiochloride, <i>see</i>	–	8	2799
BENZENESULPHONYL CHLORIDE	–	8	2225
Benzene sulphonylhydrazide (concentration 100%), <i>see</i>	–	4.1	3226
Benzenethiol, <i>see</i>	–	6.1	2337
Benzhydryl bromide, <i>see</i>	–	8	1770
BENZIDINE	–	6.1	1885
Benzol, <i>see</i>	–	3	1114
Benzolene, <i>see</i>	–	3	1268
BENZONITRILE	–	6.1	2224
BENZOQUINONE	–	6.1	2587
Benzosulphochloride, <i>see</i>	–	8	2225
BENZOTRICHLORIDE	–	8	2226
BENZOTRIFLUORIDE	–	3	2338
BENZOYL CHLORIDE	–	8	1736
BENZYL BROMIDE	–	6.1	1737
BENZYL CHLORIDE	–	6.1	1738
Benzyl chlorocarbonate, <i>see</i>	P	8	1739
BENZYL CHLOROFORMATE	P	8	1739
Benzyl cyanide, <i>see</i>	–	6.1	2470
Benzyl dichloride, <i>see</i>	–	6.1	1886
BENZYLDIMETHYLAMINE	–	8	2619
4-(Benzyl(ethyl)amino)-3-ethoxybenzenediazonium zinc chloride (concentration 100%), <i>see</i>	–	4.1	3226
BENZYLIDENE CHLORIDE	–	6.1	1886
BENZYL IODIDE	–	6.1	2653
4-(Benzyl(methyl)amino)-3-ethoxybenzenediazonium zinc chloride (concentration 100%), <i>see</i>	–	4.1	3236
BERYLLIUM COMPOUND, N.O.S.	–	6.1	1566
BERYLLIUM NITRATE	–	5.1	2464
BERYLLIUM POWDER	–	6.1	1567
<i>gamma</i> -Bhc, <i>see</i> ORGANOCHLORINE PESTICIDE	P	–	–
BHUSA	–	4.1	1327
Bichloroacetic acid, <i>see</i>	–	8	1764
BICYCLO[2.2.1]HEPTA-2,5-DIENE, STABILIZED	–	3	2251
Bifluorides, N.O.S., <i>see</i>	–	8	1740
Binapacryl, <i>see</i> SUBSTITUTED NITROPHENOL PESTICIDE	P	–	–
BIOLOGICAL SUBSTANCE, CATEGORY B	–	6.2	3373
BIOMEDICAL WASTE, N.O.S.	–	6.2	3291
(BIO)MEDICAL WASTE, N.O.S.	–	6.2	3291

Index

Substance, material or article	MP	Class	UN No.
BIPYRIDILIUM PESTICIDE, LIQUID, FLAMMABLE, TOXIC, flashpoint less than 23°C	–	3	2782
BIPYRIDILIUM PESTICIDE, LIQUID, TOXIC	–	6.1	3016
BIPYRIDILIUM PESTICIDE, LIQUID, TOXIC, FLAMMABLE, flashpoint not less than 23°C	–	6.1	3015
BIPYRIDILIUM PESTICIDE, SOLID, TOXIC	–	6.1	2781
Bis-, see Di-	–	–	–
<i>N,N</i> -Bis(2-hydroxyethyl)oleamide (loa), see Note 1	P	–	–
BISULPHATES, AQUEOUS SOLUTION	–	8	2837
BISULPHITES, AQUEOUS SOLUTION, N.O.S.	–	8	2693
Bitumen, see	–	3	1999
BLACK POWDER, COMPRESSED	–	1.1D	0028
BLACK POWDER granular, or as a meal	–	1.1D	0027
BLACK POWDER IN PELLETS	–	1.1D	0028
Blasticidin-S-3, see PESTICIDE, N.O.S.	–	–	–
Bleaching powder, see	–	5.1	2208
Bleach liquor, see	–	8	1791
BLUE ASBESTOS	–	9	2212
Bombs, illuminating, see AMMUNITION, ILLUMINATING	–	–	–
BOMBS, PHOTO-FLASH	–	1.1D	0038
BOMBS, PHOTO-FLASH	–	1.1F	0037
BOMBS, PHOTO-FLASH	–	1.2G	0039
BOMBS, PHOTO-FLASH	–	1.3G	0299
BOMBS, SMOKE, NON-EXPLOSIVE with corrosive liquid, without initiating device	–	8	2028
Bombs, target identification, see AMMUNITION, ILLUMINATING	–	–	–
BOMBS with bursting charge	–	1.1D	0034
BOMBS with bursting charge	–	1.1F	0033
BOMBS with bursting charge	–	1.2D	0035
BOMBS with bursting charge	–	1.2F	0291
BOMBS WITH FLAMMABLE LIQUID with bursting charge	–	1.1J	0399
BOMBS WITH FLAMMABLE LIQUID with bursting charge	–	1.2J	0400
BOOSTERS WITH DETONATOR	–	1.1B	0225
BOOSTERS WITH DETONATOR	–	1.2B	0268
BOOSTERS without detonator	–	1.1D	0042
BOOSTERS without detonator	–	1.2D	0283
Borate and chlorate mixture, see	–	5.1	1458
BORNEOL	–	4.1	1312
Bornyl alcohol, see	–	4.1	1312
Boroethane, compressed, see	–	2.3	1911
Boron bromide, see	–	8	2692
Boron fluoride, compressed, see	–	2.3	1008
BORON TRIBROMIDE	–	8	2692
BORON TRICHLORIDE	–	2.3	1741

Substance, material or article	MP	Class	UN No.
BORON TRIFLUORIDE	–	2.3	1008
BORON TRIFLUORIDE ACETIC ACID COMPLEX, LIQUID	–	8	1742
BORON TRIFLUORIDE ACETIC ACID COMPLEX, SOLID	–	8	3419
BORON TRIFLUORIDE DIETHYL ETHERATE	–	8	2604
BORON TRIFLUORIDE DIHYDRATE	–	8	2851
BORON TRIFLUORIDE DIMETHYL ETHERATE	–	4.3	2965
BORON TRIFLUORIDE PROPIONIC ACID COMPLEX, LIQUID	–	8	1743
BORON TRIFLUORIDE PROPIONIC ACID COMPLEX, SOLID	–	8	3420
Brodifacoum, <i>see</i> COUMARIN DERIVATIVE PESTICIDE	P	–	–
BROMATES, INORGANIC, AQUEOUS SOLUTION, N.O.S.	–	5.1	3213
BROMATES, INORGANIC, N.O.S.	–	5.1	1450
BROMINE	–	8	1744
BROMINE CHLORIDE	–	2.3	2901
Bromine cyanide, <i>see</i>	P	6.1	1889
BROMINE PENTAFLUORIDE	–	5.1	1745
BROMINE SOLUTION	–	8	1744
BROMINE TRIFLUORIDE	–	5.1	1746
BROMOACETIC ACID, SOLID	–	8	3425
BROMOACETIC ACID SOLUTION	–	8	1938
BROMOACETONE	P	6.1	1569
<i>omega</i> -Bromoacetone, <i>see</i>	–	6.1	2645
BROMOACETYL BROMIDE	–	8	2513
Bromoallylene, <i>see</i>	P	3	1099
BROMOBENZENE	P	3	2514
BROMOBENZYL CYANIDES, LIQUID	–	6.1	1694
BROMOBENZYL CYANIDES, SOLID	–	6.1	3449
1-BROMOBUTANE	–	3	1126
2-BROMOBUTANE	–	3	2339
Bromochlorodifluoromethane, <i>see</i>	–	2.2	1974
BROMOCHLOROMETHANE	–	6.1	1887
1-BROMO-3-CHLOROPROPANE	–	6.1	2688
Bromocyane, <i>see</i>	P	6.1	1889
Bromodiphenylmethane, <i>see</i>	–	8	1770
1-Bromo-2,3-epoxypropane, <i>see</i>	P	6.1	2558
Bromoethane, <i>see</i>	–	6.1	1891
2-BROMOETHYL ETHYL ETHER	–	3	2340
BROMOFORM	P	6.1	2515
Bromomethane, <i>see</i>	–	2.3	1062
1-BROMO-3-METHYLBUTANE	–	3	2341
BROMOMETHYLPROPANES	–	3	2342
Bromonitrobenzenes, liquid, <i>see</i>	–	6.1	2732
Bromonitrobenzenes, solid, <i>see</i>	–	6.1	3459
2-BROMO-2-NITROPROPANE-1,3-DIOL	–	4.1	3241

Index

Substance, material or article	MP	Class	UN No.
2-BROMOPENTANE	–	3	2343
Bromophos-ethyl, <i>see</i> ORGANOPHOSPHORUS PESTICIDE	P	–	–
BROMOPROPANES	–	3	2344
3-Bromopropene, <i>see</i>	P	3	1099
3-BROMOPROPYNE	–	3	2345
3-Bromo-1-propyne, <i>see</i>	–	3	2345
<i>alpha</i> -Bromotoluene, <i>see</i>	–	6.1	1737
BROMOTRIFLUOROETHYLENE	–	2.1	2419
BROMOTRIFLUOROMETHANE	–	2.2	1009
Bromoxynil, <i>see</i> PESTICIDE, N.O.S.	P	–	–
Bronopol, <i>see</i>	–	4.1	3241
BROWN ASBESTOS	–	9	2212
BRUCINE	–	6.1	1570
BURSTERS explosive	–	1.1D	0043
But-1-yne, stabilized, <i>see</i>	–	2.1	2452
BUTADIENES AND HYDROCARBON MIXTURE, STABILIZED containing more than 40% butadienes, stabilized	–	2.1	1010
BUTADIENES, STABILIZED	–	2.1	1010
Butanal, <i>see</i>	–	3	1129
Butanal oxime, <i>see</i>	–	3	2840
BUTANE	–	2.1	1011
BUTANEDIONE	–	3	2346
Butane-1-thiol, <i>see</i>	–	3	2347
Butanoic acid, <i>see</i>	–	8	2820
Butanoic anhydride, <i>see</i>	–	8	2739
Butan-2-ol, <i>see</i>	–	3	1120
1-Butanol, <i>see</i>	–	3	1120
Butanol, secondary, <i>see</i>	–	3	1120
Butanol, tertiary, <i>see</i>	–	3	1120
3-Butanolal, <i>see</i>	–	6.1	2839
BUTANOLS	–	3	1120
2-Butanone, <i>see</i>	–	3	1193
Butanoyl chloride, <i>see</i>	–	3	2353
2-Butenal, stabilized, <i>see</i>	P	6.1	1143
Butene, <i>see</i>	–	2.1	1012
But-1-ene-3-one, stabilized, <i>see</i>	–	6.1	1251
1,2-Butene oxide, stabilized, <i>see</i>	–	3	3022
2-Butenoic acid, liquid, <i>see</i>	–	8	3472
2-Butenoic acid, solid, <i>see</i>	–	8	2823
2-Buten-1-ol, <i>see</i>	–	3	2614
Butocarboxim, <i>see</i> CARBAMATE PESTICIDE	–	–	–
BUTYL ACETATES	–	3	1123
Butyl acetate, secondary, <i>see</i>	–	3	1123

Substance, material or article	MP	Class	UN No.
BUTYL ACID PHOSPHATE	–	8	1718
BUTY ACRYLATES, STABILIZED	–	3	2348
Butyl alcohols, <i>see</i>	–	3	1120
Butyl aldehyde, <i>see</i>	–	3	1129
<i>n</i> -BUTYLAMINE	–	3	1125
<i>N</i> -BUTYLANILINE	–	6.1	2738
BUTYLBENZENES	–	3	2709
Butyl benzyl phthalate, <i>see</i>	P	9	3082
<i>n</i> -Butyl bromide, <i>see</i>	–	3	1126
<i>secondary</i> -Butyl bromide, <i>see</i>	–	3	2339
<i>tertiary</i> -Butyl bromide, <i>see</i>	–	3	2342
Butyl butyrate, <i>see</i>	–	3	3272
<i>n</i> -Butyl chloride, <i>see</i>	–	3	1127
<i>secondary</i> -Butyl chloride, <i>see</i>	–	3	1127
<i>tertiary</i> -Butyl chloride, <i>see</i>	–	3	1127
<i>n</i> -BUTYL CHLOROFORMATE	–	6.1	2743
<i>tert</i> -Butyl cumyl peroxide (concentration >42–100%), <i>see</i>	–	5.2	3107
<i>tert</i> -Butyl cumyl peroxide (concentration ≤52%, with inert solid), <i>see</i>	–	5.2	3108
<i>tert</i> -BUTYLCYCLOHEXYL CHLOROFORMATE	–	6.1	2747
<i>N</i> <sup>2</sup> - <i>tert</i> -Butyl- <i>N</i> <sup>4</sup> -cyclopropyl-6-methylthio-1,3,5-triazine-2,4-diamine, <i>see</i>	P	9	3077
<i>n</i> -Butyl 4,4-di-( <i>tert</i> -butylperoxy)valerate (concentration ≤52%, with inert solid), <i>see</i>	–	5.2	3108
<i>n</i> -Butyl 4,4-di-( <i>tert</i> -butylperoxy)valerate (concentration >52–100%), <i>see</i>	–	5.2	3103
BUTYLENE	–	2.1	1012
1,2-BUTYLENE OXIDE, STABILIZED	–	3	3022
Butyl ethers, <i>see</i>	–	3	1149
Butyl ethyl ether, <i>see</i>	–	3	1179
<i>n</i> -BUTYL FORMATE	–	3	1128
<i>tert</i> -Butyl hydroperoxide (concentration ≤72%, with water), <i>see</i>	–	5.2	3109
<i>tert</i> -Butyl hydroperoxide (concentration ≤79%, with water), <i>see</i>	–	5.2	3107
<i>tert</i> -Butyl hydroperoxide (concentration >79–90%, with water), <i>see</i>	–	5.2	3103
<i>tert</i> -Butyl hydroperoxide (concentration ≤80%, with diluent Type A), <i>see</i>	–	5.2	3105
<i>tert</i> -Butyl hydroperoxide (concentration <82%) + di- <i>tert</i> -butyl peroxide (concentration >9%), with water, <i>see</i>	–	5.2	3103
<i>tert</i> -BUTYL HYPOCHLORITE	–	4.2	3255
<i>N-n</i> -BUTYLIMIDAZOLE	–	6.1	2690
<i>N, n</i> -Butyliminazole, <i>see</i>	–	6.1	2690
<i>secondary</i> -Butyl iodide, <i>see</i>	–	3	2390
<i>tertiary</i> -Butyl iodide, <i>see</i>	–	3	2391
<i>tert</i> -BUTYL ISOCYANATE	–	6.1	2484
<i>n</i> -BUTYL ISOCYANATE	–	6.1	2485
BUTYL MERCAPTAN	–	3	2347



Index

Substance, material or article	MP	Class	UN No.
<i>n</i> -BUTYL METHACRYLATE, STABILIZED	–	3	2227
Butyl 2-methylacrylate, stabilized, <i>see</i>	–	3	2227
BUTYL METHYL ETHER	–	3	2350
<i>tert</i> -Butyl monoperoxymaleate (concentration ≤52%, as a paste), <i>see</i>	–	5.2	3108
<i>tert</i> -Butyl monoperoxymaleate (concentration ≤52%, with diluent Type A), <i>see</i>	–	5.2	3103
<i>tert</i> -Butyl monoperoxymaleate (concentration ≤52%, with inert solid), <i>see</i>	–	5.2	3108
<i>tert</i> -Butyl monoperoxymaleate (concentration >52–100%), <i>see</i>	–	5.2	3102
BUTYL NITRITES	–	3	2351
<i>tert</i> -Butyl peroxyacetate (concentration ≤32%, with diluent Type B), <i>see</i>	–	5.2	3109
<i>tert</i> -Butyl peroxyacetate (concentration >32–52%, with diluent Type A), <i>see</i>	–	5.2	3103
<i>tert</i> -Butyl peroxyacetate (concentration >52–77%, with diluent Type A), <i>see</i>	–	5.2	3101
<i>tert</i> -Butyl peroxybenzoate (concentration ≤52%, with inert solid), <i>see</i>	–	5.2	3106
<i>tert</i> -Butyl peroxybenzoate (concentration >52–77%, with diluent Type A), <i>see</i>	–	5.2	3105
<i>tert</i> -Butyl peroxybenzoate (concentration >77–100%, with diluent Type A), <i>see</i>	–	5.2	3103
<i>tert</i> -Butyl peroxybutyl fumarate (concentration ≤52%, with diluent Type A), <i>see</i>	–	5.2	3105
<i>tert</i> -Butyl peroxycrotonate (concentration ≤77%, with diluent Type A), <i>see</i>	–	5.2	3105
<i>tert</i> -Butyl peroxydiethylacetate (concentration ≤100%), <i>see</i>	–	5.2	3113
<i>tert</i> -Butyl peroxy-2-ethylhexanoate (concentration ≤12%) + 2,2-di-( <i>tert</i> -butylperoxy)butane (concentration ≤14%), with diluent Type A and inert solid, <i>see</i>	–	5.2	3106
<i>tert</i> -Butyl peroxy-2-ethylhexanoate (concentration ≤31%) + 2,2-di-( <i>tert</i> -butylperoxy)butane (concentration ≤36%), with diluent Type B, <i>see</i>	–	5.2	3115
<i>tert</i> -Butyl peroxy-2-ethylhexanoate (concentration ≤32%, with diluent Type B), <i>see</i>	–	5.2	3119
<i>tert</i> -Butyl peroxy-2-ethylhexanoate (concentration >32–52%, with diluent Type B), <i>see</i>	–	5.2	3117
<i>tert</i> -Butyl peroxy-2-ethylhexanoate (concentration ≤52%, with inert solid), <i>see</i>	–	5.2	3118
<i>tert</i> -Butyl peroxy-2-ethylhexanoate (concentration >52–100%), <i>see</i>	–	5.2	3113
<i>tert</i> -Butyl peroxy-2-ethylhexylcarbonate (concentration ≤100%), <i>see</i>	–	5.2	3105
<i>tert</i> -Butyl peroxyisobutyrate (concentration ≤52%, with diluent Type B), <i>see</i>	–	5.2	3115
<i>tert</i> -Butyl peroxyisobutyrate (concentration >52–77%, with diluent Type B), <i>see</i>	–	5.2	3111
<i>tert</i> -Butyl peroxy isopropyl carbonate (concentration ≤77%, with diluent Type A), <i>see</i>	–	5.2	3103
1-(2- <i>tert</i> -Butylperoxyisopropyl)-3-isopropenylbenzene (concentration ≤42%, with inert solid), <i>see</i>	–	5.2	3108

Substance, material or article	MP	Class	UN No.
1-(2- <i>tert</i> -Butylperoxy isopropyl)-3-isopropenylbenzene (concentration $\leq 77\%$ , with diluent Type A), <i>see</i>	–	5.2	3105
<i>tert</i> -Butyl peroxy-2-methylbenzoate (concentration $\leq 100\%$ ), <i>see</i>	–	5.2	3103
<i>tert</i> -Butyl peroxyneodecanoate (concentration $\leq 32\%$ , with diluent Type A), <i>see</i>	–	5.2	3119
<i>tert</i> -Butyl peroxyneodecanoate (concentration $\leq 42\%$ , as a stable dispersion in water (frozen)), <i>see</i>	–	5.2	3118
<i>tert</i> -Butyl peroxyneodecanoate (concentration $\leq 52\%$ , as a stable dispersion in water), <i>see</i>	–	5.2	3119
<i>tert</i> -Butyl peroxyneodecanoate (concentration $\leq 77\%$ , with diluent Type B), <i>see</i>	–	5.2	3115
<i>tert</i> -Butyl peroxyneodecanoate (concentration $> 77-100\%$ ), <i>see</i>	–	5.2	3115
<i>tert</i> -Butyl peroxyneooheptanoate (concentration $\leq 42\%$ , as a stable dispersion in water), <i>see</i>	–	5.2	3117
<i>tert</i> -Butyl peroxyneooheptanoate (concentration $\leq 77\%$ , with diluent Type A), <i>see</i>	–	5.2	3115
<i>tert</i> -Butyl peroxy-pivalate (concentration $\leq 27\%$ , with diluent Type B), <i>see</i>	–	5.2	3119
<i>tert</i> -Butyl peroxy-pivalate (concentration $> 27-67\%$ , with diluent Type B), <i>see</i>	–	5.2	3115
<i>tert</i> -Butyl peroxy-pivalate (concentration $> 67-77\%$ , with diluent Type A), <i>see</i>	–	5.2	3113
<i>tert</i> -Butyl peroxy-stearylcarbonate (concentration $\leq 100\%$ ), <i>see</i>	–	5.2	3106
<i>tert</i> -Butyl peroxy-3,5,5-trimethylhexanoate (concentration $\leq 32\%$ , with diluent Type B), <i>see</i>	–	5.2	3109
<i>tert</i> -Butyl peroxy-3,5,5-trimethylhexanoate (concentration $> 32-100\%$ ), <i>see</i>	–	5.2	3105
<i>tert</i> -Butyl peroxy-3,5,5-trimethylhexanoate (concentration $\leq 42\%$ , with inert solid)	–	5.2	3106
Butylphenols, liquid, N.O.S., <i>see</i>	–	8	3145
Butylphenols, solid, N.O.S., <i>see</i>	–	8	2430
Butylphosphoric acid, <i>see</i>	–	8	1718
BUTYL PROPIONATES	–	3	1914
Butyl thioalcohols, <i>see</i>	–	3	2347
BUTYL TOLUENES	–	6.1	2667
BUTYLTRICHLOROSILANE	–	8	1747
5- <i>tert</i> -BUTYL-2,4,6-TRINITRO- <i>m</i> -XYLENE	–	4.1	2956
BUTYL VINYL ETHER, STABILIZED	–	3	2352
1-Butyne, stabilized, <i>see</i>	–	2.1	2452
2-Butyne, <i>see</i>	–	3	1144
1,4-BUTYNE DIOL	–	6.1	2716
2-Butyne-1,4-diol, <i>see</i>	–	6.1	2716
BUTYRALDEHYDE	–	3	1129
BUTYRALDOXIME	–	3	2840
BUTYRIC ACID	–	8	2820
BUTYRIC ANHYDRIDE	–	8	2739
Butyrone, <i>see</i>	–	3	2710

Index

Substance, material or article	MP	Class	UN No.
BUTYRONITRILE	–	3	2411
Butyryl chloride, <i>see</i>	–	3	2353
BUTYRYL CHLORIDE	–	3	2353
Cable cutters, explosive, <i>see</i>	–	1.4S	0070
CACODYLIC ACID	–	6.1	1572
CADMIUM COMPOUND	–	6.1	2570
Cadmium selenide, <i>see</i>	–	6.1	2570
Cadmium sulphide, <i>see</i>	P	6.1	2570
CAESIUM	–	4.3	1407
Caesium alloy, liquid, <i>see</i>	–	4.3	1421
Caesium amalgams, liquid, <i>see</i>	–	4.3	1389
Caesium amalgams, solid, <i>see</i>	–	4.3	3401
Caesium amide, <i>see</i>	–	4.3	1390
Caesium dispersions, <i>see</i>	–	4.3	1391
CAESIUM HYDROXIDE	–	8	2682
CAESIUM HYDROXIDE SOLUTION	–	8	2681
CAESIUM NITRATE	–	5.1	1451
Caesium powder, pyrophoric, <i>see</i>	–	4.2	1383
Caffeine, <i>see</i>	–	6.1	1544
Cajeputene, <i>see</i>	P	3	2052
CALCIUM	–	4.3	1401
Calcium alloy, non-pyrophoric, solid, <i>see</i>	–	4.3	1393
CALCIUM ALLOYS, PYROPHORIC	–	4.2	1855
Calcium amalgams, liquid, <i>see</i>	–	4.3	1389
Calcium amalgams, solid, <i>see</i>	–	4.3	3402
CALCIUM ARSENATE	P	6.1	1573
CALCIUM ARSENATE AND CALCIUM ARSENITE MIXTURE, SOLID	P	6.1	1574
Calcium bisulphite solution, <i>see</i>	–	8	2693
CALCIUM CARBIDE	–	4.3	1402
CALCIUM CHLORATE	–	5.1	1452
CALCIUM CHLORATE, AQUEOUS SOLUTION	–	5.1	2429
CALCIUM CHLORITE	–	5.1	1453
CALCIUM CYANAMIDE with more than 0.1% calcium carbide	–	4.3	1403
CALCIUM CYANIDE	P	6.1	1575
Calcium dispersions, <i>see</i>	–	4.3	1391
CALCIUM DITHIONITE	–	4.2	1923
CALCIUM HYDRIDE	–	4.3	1404
Calcium hydrogen sulphite solution, <i>see</i>	–	8	2693
CALCIUM HYDROSULPHITE	–	4.2	1923
CALCIUM HYPOCHLORITE, DRY with more than 39% available chlorine (8.8% available oxygen)	–	5.1	1748
CALCIUM HYPOCHLORITE, DRY, CORROSIVE with more than 39% available chlorine (8.8% available oxygen)	–	5.1	3485

Substance, material or article	MP	Class	UN No.
CALCIUM HYPOCHLORITE, HYDRATED with not less than 5.5% but no more than 16% water	–	5.1	2880
CALCIUM HYPOCHLORITE, HYDRATED MIXTURE, CORROSIVE with not less than 5.5% but not more than 16% water	–	5.1	3487
CALCIUM HYPOCHLORITE, HYDRATED, CORROSIVE with not less than 5.5% but no more than 16% water	–	5.1	3487
CALCIUM HYPOCHLORITE, HYDRATED MIXTURE with not less than 5.5% but not more than 16% water	–	5.1	2880
CALCIUM HYPOCHLORITE MIXTURE, DRY, CORROSIVE with more than 10% but not more than 39% available chlorine	–	5.1	3486
CALCIUM HYPOCHLORITE MIXTURE, DRY, CORROSIVE with more than 39% available chlorine (8.8% available oxygen)	–	5.1	3485
CALCIUM HYPOCHLORITE MIXTURE, DRY with more than 10% but not more than 39% available chlorine	–	5.1	2208
CALCIUM HYPOCHLORITE MIXTURE, DRY with more than 39% available chlorine (8.8% available oxygen)	–	5.1	1748
CALCIUM MANGANESE SILICON	–	4.3	2844
Calcium naphthenate in solution, <i>see</i>	P	9	3082
CALCIUM NITRATE	–	5.1	1454
CALCIUM OXIDE	–	8	1910
CALCIUM PERCHLORATE	–	5.1	1455
CALCIUM PERMANGANATE	–	5.1	1456
CALCIUM PEROXIDE	–	5.1	1457
CALCIUM PHOSPHIDE	–	4.3	1360
CALCIUM, PYROPHORIC	–	4.2	1855
CALCIUM RESINATE	–	4.1	1313
CALCIUM RESINATE, FUSED	–	4.1	1314
Calcium selenate, <i>see</i>	–	6.1	2630
CALCIUM SILICIDE	–	4.3	1405
Calcium silicon, <i>see</i>	–	4.3	1405
Calcium superoxide, <i>see</i>	–	5.1	1457
2-Camphanol, <i>see</i>	–	4.1	1312
2-Camphanone, <i>see</i>	–	4.1	2717
Camphechlor, <i>see</i> ORGANOCHLORINE PESTICIDE	P	–	–
CAMPHOR OIL	–	3	1130
CAMPHOR, synthetic	–	4.1	2717
CAPACITOR, electric double layer (with an energy storage capacity greater than 0.3 Wh)	–	9	3499
CAPROIC ACID	–	8	2829
Caproic aldehyde, <i>see</i>	–	3	1207
Caprylyl chloride, <i>see</i>	–	8	3265
CARBAMATE PESTICIDE, LIQUID, FLAMMABLE, TOXIC, flashpoint less than 23°C	–	3	2758
CARBAMATE PESTICIDE, LIQUID, TOXIC	–	6.1	2992
CARBAMATE PESTICIDE, LIQUID, TOXIC, FLAMMABLE, flashpoint not less than 23°C	–	6.1	2991
CARBAMATE PESTICIDE, SOLID, TOXIC	–	6.1	2757

Index

Substance, material or article	MP	Class	UN No.
Carbanil, <i>see</i>	–	6.1	2487
Carbaryl, <i>see</i> CARBAMATE PESTICIDE	P	–	–
Carbendazim, <i>see</i> <b>Note 1</b>	P	–	–
Carbofuran, <i>see</i> CARBAMATE PESTICIDE	P	–	–
Carbolic acid, molten, <i>see</i>	–	6.1	2312
Carbolic acid, solid, <i>see</i>	–	6.1	1671
Carbolic acid solution, <i>see</i>	–	6.1	2821
CARBON, ACTIVATED	–	4.2	1362
CARBON animal origin	–	4.2	1361
Carbon bisulphide, <i>see</i>	–	3	1131
Carbon black, <i>see</i>	–	4.2	1361
CARBON DIOXIDE	–	2.2	1013
Carbon dioxide and ethylene oxide mixture, <i>see</i> ETHYLENE OXIDE AND CARBON DIOXIDE MIXTURE	–	–	–
CARBON DIOXIDE, REFRIGERATED LIQUID	–	2.2	2187
CARBON DIOXIDE, SOLID	–	9	1845
CARBON DISULPHIDE	–	3	1131
Carbonic anhydride, <i>see</i>	–	2.2	1013
Carbonic anhydride, refrigerated liquid, <i>see</i>	–	2.2	2187
Carbonic anhydride, solid	–	9	1845
CARBON MONOXIDE, COMPRESSED	–	2.3	1016
Carbon oxisulphide, <i>see</i>	–	2.3	2204
Carbon oxyfluoride, <i>see</i>	–	2.3	2417
Carbon oxyfluoride, compressed, <i>see</i>	–	2.3	2417
Carbon oxysulphide, <i>see</i>	–	2.3	2204
Carbon paper, <i>see</i>	–	4.2	1379
CARBON TETRABROMIDE	P	6.1	2516
CARBON TETRACHLORIDE	P	6.1	1846
CARBON vegetable origin	–	4.2	1361
Carbonyl chloride, <i>see</i>	–	2.3	1076
CARBONYL FLUORIDE	–	2.3	2417
CARBONYL SULPHIDE	–	2.3	2204
Carbophenothion, <i>see</i> ORGANOPHOSPHORUS PESTICIDE	P	–	–
Cargo transport unit under fumigation, <i>see</i>	–	9	3359
Cartap hydrochloride, <i>see</i> CARBAMATE PESTICIDE	P	–	–
Cartridge cases, <i>see</i> CASES, CARTRIDGE	–	–	–
Cartridges, actuating, for fire extinguisher or apparatus valve, <i>see</i> CARTRIDGES, POWER DEVICE	–	–	–
Cartridges, explosive, <i>see</i>	–	1.1D	0048
CARTRIDGES, FLASH	–	1.1G	0049
CARTRIDGES, FLASH	–	1.3G	0050
CARTRIDGES FOR TOOLS, BLANK	–	1.4S	0014
CARTRIDGES FOR WEAPONS, BLANK	–	1.1C	0326
CARTRIDGES FOR WEAPONS, BLANK	–	1.2C	0413

Substance, material or article	MP	Class	UN No.
CARTRIDGES FOR WEAPONS, BLANK	–	1.3C	0327
CARTRIDGES FOR WEAPONS, BLANK	–	1.4C	0338
CARTRIDGES FOR WEAPONS, BLANK	–	1.4S	0014
CARTRIDGES FOR WEAPONS, INERT PROJECTILE	–	1.2C	0328
CARTRIDGES FOR WEAPONS, INERT PROJECTILE	–	1.3C	0417
CARTRIDGES FOR WEAPONS, INERT PROJECTILE	–	1.4C	0339
CARTRIDGES FOR WEAPONS, INERT PROJECTILE	–	1.4S	0012
CARTRIDGES FOR WEAPONS with bursting charge	–	1.1E	0006
CARTRIDGES FOR WEAPONS with bursting charge	–	1.1F	0005
CARTRIDGES FOR WEAPONS with bursting charge	–	1.2E	0321
CARTRIDGES FOR WEAPONS with bursting charge	–	1.2F	0007
CARTRIDGES FOR WEAPONS with bursting charge	–	1.4E	0412
CARTRIDGES FOR WEAPONS with bursting charge	–	1.4F	0348
Cartridges, illuminating, <i>see</i> AMMUNITION, ILLUMINATING	–	–	–
CARTRIDGES, OIL WELL	–	1.3C	0277
CARTRIDGES, OIL WELL	–	1.4C	0278
CARTRIDGES, POWER DEVICE	–	1.2C	0381
CARTRIDGES, POWER DEVICE	–	1.3C	0275
CARTRIDGES, POWER DEVICE	–	1.4C	0276
CARTRIDGES, POWER DEVICE	–	1.4S	0323
CARTRIDGES, SIGNAL	–	1.3G	0054
CARTRIDGES, SIGNAL	–	1.4G	0312
CARTRIDGES, SIGNAL	–	1.4S	0405
CARTRIDGES, SMALL ARMS	–	1.3C	0417
CARTRIDGES, SMALL ARMS	–	1.4C	0339
CARTRIDGES, SMALL ARMS	–	1.4S	0012
CARTRIDGES, SMALL ARMS, BLANK	–	1.3C	0327
CARTRIDGES, SMALL ARMS, BLANK	–	1.4C	0338
CARTRIDGES, SMALL ARMS, BLANK	–	1.4S	0014
Cartridges, starter, jet engine, <i>see</i> CARTRIDGES, POWER DEVICE	–	–	–
CASES, CARTRIDGE, EMPTY, WITH PRIMER	–	1.4C	0379
CASES, CARTRIDGE, EMPTY, WITH PRIMER	–	1.4S	0055
CASES, COMBUSTIBLE, EMPTY, WITHOUT PRIMER	–	1.3C	0447
CASES, COMBUSTIBLE, EMPTY, WITHOUT PRIMER	–	1.4C	0446
Casinghead gasoline, <i>see</i>	P	3	1203
CASTOR BEANS	–	9	2969
CASTOR FLAKE	–	9	2969
CASTOR MEAL	–	9	2969
CASTOR POMACE	–	9	2969
CAUSTIC ALKALI LIQUID, N.O.S.	–	8	1719
Caustic potash solution, <i>see</i>	–	8	1814
Caustic potash, solid, <i>see</i>	–	8	1813
Caustic soda liquor, <i>see</i>	–	8	1824

Index

Substance, material or article	MP	Class	UN No.
Caustic soda, solid, <i>see</i>	–	8	1823
Caustic soda solution, <i>see</i>	–	8	1824
CELLS, CONTAINING SODIUM	–	4.3	3292
CELLULOID in block, rods, rolls, sheets, tubes, etc., except scrap	–	4.1	2000
CELLULOID, SCRAP	–	4.2	2002
Cellulose nitrate solution, <i>see</i>	–	3	2059
Cellulose nitrate with alcohol, <i>see</i>	–	4.1	2556
Cellulose nitrate with plasticizing substance, <i>see</i>	–	4.1	2557
Cellulose nitrate with water, <i>see</i>	–	4.1	2555
Cement, liquid, <i>see</i>	–	3	1133
CERIUM gritty powder	–	4.3	3078
CERIUM ingots	–	4.1	1333
Cerium powder, pyrophoric, <i>see</i>	–	4.2	1383
CERIUM rods	–	4.1	1333
CERIUM slabs	–	4.1	1333
CERIUM turnings	–	4.3	3078
Cer Mischmetall, <i>see</i>	–	4.1	1323
Cesium, <i>see</i> CAESIUM	–	–	–
Charcoal, activated, <i>see</i>	–	4.2	1362
Charcoal, non-activated, <i>see</i>	–	4.2	1361
CHARGES, BURSTING, PLASTICS BONDED	–	1.1D	0457
CHARGES, BURSTING, PLASTICS BONDED	–	1.2D	0458
CHARGES, BURSTING, PLASTICS BONDED	–	1.4D	0459
CHARGES, BURSTING, PLASTICS BONDED	–	1.4S	0460
CHARGES, DEMOLITION	–	1.1D	0048
CHARGES, DEPTH	–	1.1D	0056
Charges, expelling, explosive, for fire extinguishers, <i>see</i> CARTRIDGES, POWER DEVICE	–	–	–
CHARGES, EXPLOSIVE, COMMERCIAL without detonator	–	1.1D	0442
CHARGES, EXPLOSIVE, COMMERCIAL without detonator	–	1.2D	0443
CHARGES, EXPLOSIVE, COMMERCIAL without detonator	–	1.4D	0444
CHARGES, EXPLOSIVE, COMMERCIAL without detonator	–	1.4S	0445
CHARGES, PROPELLING	–	1.1C	0271
CHARGES, PROPELLING	–	1.2C	0415
CHARGES, PROPELLING	–	1.3C	0272
CHARGES, PROPELLING	–	1.4C	0491
CHARGES, PROPELLING, FOR CANNON	–	1.1C	0279
CHARGES, PROPELLING, FOR CANNON	–	1.2C	0414
CHARGES, PROPELLING, FOR CANNON	–	1.3C	0242
CHARGES, SHAPED, FLEXIBLE, LINEAR	–	1.1D	0288
CHARGES, SHAPED, FLEXIBLE, LINEAR	–	1.4D	0237
CHARGES, SHAPED without detonator	–	1.1D	0059
CHARGES, SHAPED without detonator	–	1.2D	0439

Substance, material or article	MP	Class	UN No.
CHARGES, SHAPED without detonator	–	1.4D	0440
CHARGES, SHAPED without detonator	–	1.4S	0441
CHARGES, SUPPLEMENTARY, EXPLOSIVE	–	1.1D	0060
CHEMICAL KIT	–	9	3316
CHEMICAL SAMPLE, TOXIC	–	6.1	3315
CHEMICAL UNDER PRESSURE, N.O.S.	–	2.2	3500
CHEMICAL UNDER PRESSURE, CORROSIVE, N.O.S.	–	2.2	3503
CHEMICAL UNDER PRESSURE, FLAMMABLE, N.O.S.	–	2.1	3501
CHEMICAL UNDER PRESSURE, FLAMMABLE, CORROSIVE, N.O.S.	–	2.1	3505
CHEMICAL UNDER PRESSURE, FLAMMABLE, TOXIC, N.O.S.	–	2.1	3504
CHEMICAL UNDER PRESSURE, TOXIC, N.O.S.	–	2.2	3502
Chile saltpetre, see	–	5.1	1498
Chinomethionat, see PESTICIDE, N.O.S.	–	–	–
CHLORAL, ANHYDROUS, STABILIZED	–	6.1	2075
CHLORATE AND BORATE MIXTURE	–	5.1	1458
CHLORATE AND MAGNESIUM CHLORIDE MIXTURE, SOLID	–	5.1	1459
CHLORATE AND MAGNESIUM CHLORIDE MIXTURE SOLUTION	–	5.1	3407
CHLORATES, INORGANIC, AQUEOUS SOLUTION, N.O.S.	–	5.1	3210
CHLORATES, INORGANIC, N.O.S.	–	5.1	1461
Chlordane, see ORGANOCHLORINE PESTICIDE	P	–	–
Chlordimeform, see ORGANOCHLORINE PESTICIDE	–	–	–
Chlordimeform hydrochloride, see ORGANOCHLORINE PESTICIDE	–	–	–
Chlorfenvinphos, see ORGANOPHOSPHORUS PESTICIDE	P	–	–
CHLORIC ACID, AQUEOUS SOLUTION with a concentration exceeding 10% (transport prohibited)	–	–	–
CHLORIC ACID, AQUEOUS SOLUTION with not more than 10% chloric acid	–	5.1	2626
Chlorinated paraffins (C <sub>10</sub> –C <sub>13</sub> ), see	P	9	3082
Chlorinated paraffins (C <sub>14</sub> –C <sub>17</sub> ) with more than 1% shorter chain length, see	P	9	3082
CHLORINE	P	2.3	1017
Chlorine bromide, see	–	2.3	2901
Chlorine cyanide, stabilized, see	P	2.3	1589
CHLORINE PENTAFLUORIDE	–	2.3	2548
CHLORINE TRIFLUORIDE	–	2.3	1749
CHLORITES, INORGANIC, N.O.S.	–	5.1	1462
CHLORITE SOLUTION	–	8	1908
Chlormephos, see ORGANOPHOSPHORUS PESTICIDE	P	–	–
Chloroacetaldehyde, see	–	6.1	2232
CHLOROACETIC ACID, MOLTEN	–	6.1	3250
CHLOROACETIC ACID, SOLID	–	6.1	1751
CHLOROACETIC ACID SOLUTION	–	6.1	1750
CHLOROACETONE, STABILIZED	P	6.1	1695
CHLOROACETONITRILE	–	6.1	2668



Index

Substance, material or article	MP	Class	UN No.
CHLOROACETOPHENONE, LIQUID	–	6.1	3416
CHLOROACETOPHENONE, SOLID	–	6.1	1697
CHLOROACETYL CHLORIDE	–	6.1	1752
<i>para</i> -Chloro- <i>ortho</i> -aminophenol, <i>see</i>	–	6.1	2673
2-Chloroaniline, <i>see</i>	–	6.1	2019
3-Chloroaniline, <i>see</i>	–	6.1	2019
4-Chloroaniline, <i>see</i>	–	6.1	2018
<i>meta</i> -Chloroaniline, <i>see</i>	–	6.1	2019
<i>ortho</i> -Chloroaniline, <i>see</i>	–	6.1	2019
<i>para</i> -Chloroaniline, <i>see</i>	–	6.1	2018
CHLOROANILINES, LIQUID	–	6.1	2019
CHLOROANILINES, SOLID	–	6.1	2018
CHLOROANISIDINES	–	6.1	2233
CHLOROBENZENE	–	3	1134
CHLOROBENZOTRIFLUORIDES	–	3	2234
CHLOROBENZYL CHLORIDES, LIQUID	P	6.1	2235
CHLOROBENZYL CHLORIDES, SOLID	P	6.1	3427
1-Chloro-3-bromopropane, <i>see</i>	–	6.1	2688
2-Chlorobutadiene-1,3, stabilized, <i>see</i>	–	3	1991
1-Chlorobutane, <i>see</i>	–	3	1127
2-Chlorobutane, <i>see</i>	–	3	1127
CHLOROBUTANES	–	3	1127
Chlorocarbonates, toxic, corrosive, flammable, n.o.s., <i>see</i>	–	6.1	2742
Chlorocarbonates, toxic, corrosive, n.o.s., <i>see</i>	–	6.1	3277
CHLOROCRESOLS, SOLID	–	6.1	3437
CHLOROCRESOLS SOLUTION	–	6.1	2669
3-Chloro-4-diethylaminobenzenediazonium zinc chloride (concentration 100%), <i>see</i>	–	4.1	3226
CHLORODIFLUORBROMOMETHANE	–	2.2	1974
1-CHLORO-1,1-DIFLUOROETHANE	–	2.1	2517
CHLORODIFLUOROMETHANE	–	2.2	1018
CHLORODIFLUOROMETHANE AND CHLOROPENTAFLUOROETHANE MIXTURE with a fixed boiling point, with approximately 49% chlorodifluoromethane	–	2.2	1973
3-Chloro-1,2-dihydroxypropane, <i>see</i>	–	6.1	2689
Chlorodimethyl ether, <i>see</i>	–	6.1	1239
CHLORODINITROBENZENES, LIQUID	P	6.1	1577
CHLORODINITROBENZENES, SOLID	P	6.1	3441
2-CHLOROETHANAL	–	6.1	2232
Chloroethane, <i>see</i>	–	2.1	1037
Chloroethane nitrile, <i>see</i>	–	6.1	2668
2-Chloroethanol, <i>see</i>	–	6.1	1135
2-Chloroethyl alcohol, <i>see</i>	–	6.1	1135
CHLOROFORM	–	6.1	1888

Substance, material or article	MP	Class	UN No.
CHLOROFORMATES, TOXIC, CORROSIVE, FLAMMABLE, N.O.S.	–	6.1	2742
CHLOROFORMATES, TOXIC, CORROSIVE, N.O.S.	–	6.1	3277
Chloromethane, <i>see</i>	–	2.1	1063
1-Chloro-3-methylbutane, <i>see</i>	–	3	1107
2-Chloro-2-methylbutane, <i>see</i>	–	3	1107
CHLOROMETHYL CHLOROFORMATE	–	6.1	2745
Chloromethyl cyanide, <i>see</i>	–	6.1	2668
CHLOROMETHYL ETHYL ETHER	–	3	2354
Chloromethyl methyl ether, <i>see</i>	–	6.1	1239
Chloromethylphenols, solution, <i>see</i>	–	6.1	2669
Chloromethylphenols, solid, <i>see</i>	–	6.1	3437
3-CHLORO-4-METHYLPHENYL ISOCYANATE, LIQUID	–	6.1	2236
3-CHLORO-4-METHYLPHENYL ISOCYANATE, SOLID	–	6.1	3428
Chloromethylpropanes, <i>see</i>	–	3	1127
3-Chloro-2-methylprop-1-ene, <i>see</i>	–	3	2554
CHLORONITROANILINES	P	6.1	2237
CHLORONITROBENZENES, LIQUID	–	6.1	3409
CHLORONITROBENZENES, SOLID	–	6.1	1578
2-Chloro-6-nitrotoluene, <i>see Note 1</i>	P	–	–
CHLORONITROTOLUENES, LIQUID	P	6.1	2433
CHLORONITROTOLUENES, SOLID	P	6.1	3457
1-Chlorooctane, <i>see</i>	P	9	3082
CHLOROPENTAFLUOROETHANE	–	2.2	1020
Chloropentanes, <i>see</i>	–	3	1107
3-Chloroperoxybenzoic acid (concentration $\leq 57\%$ , with inert solid and water), <i>see</i>	–	5.2	3106
3-Chloroperoxybenzoic acid (concentration $>57-86\%$ , with inert solid), <i>see</i>	–	5.2	3102
3-Chloroperoxybenzoic acid (concentration $\leq 77\%$ with inert solid and water), <i>see</i>	–	5.2	3106
Chlorophacinone, <i>see</i> ORGANOCHLORINE PESTICIDE	–	–	–
CHLOROPHENOLATES, LIQUID	–	8	2904
CHLOROPHENOLATES, SOLID	–	8	2905
CHLOROPHENOLS, LIQUID	–	6.1	2021
CHLOROPHENOLS, SOLID	–	6.1	2020
CHLOROPHENYLTRICHLOROSILANE	P	8	1753
CHLOROPICRIN	P	6.1	1580
CHLOROPICRIN AND METHYL BROMIDE MIXTURE with more than 2% chloropicrin	–	2.3	1581
CHLOROPICRIN AND METHYL CHLORIDE MIXTURE	–	2.3	1582
CHLOROPICRIN MIXTURE, N.O.S.	–	6.1	1583
CHLOROPLATINIC ACID, SOLID	–	8	2507
CHLOROPRENE, STABILIZED	–	3	1991
1-CHLOROPROPANE	–	3	1278

Index

Substance, material or article	MP	Class	UN No.
2-CHLOROPROPANE	–	3	2356
3-Chloropropanediol-1,2, <i>see</i>	–	6.1	2689
1-Chloro-2-propanol, <i>see</i>	–	6.1	2611
3-CHLOROPROPANOL-1	–	6.1	2849
2-CHLOROPROPENE	–	3	2456
3-Chloropropene, <i>see</i>	–	3	1100
3-Chloroprop-1-ene, <i>see</i>	–	3	1100
2-CHLOROPROPIONIC ACID	–	8	2511
<i>alpha</i> -Chloropropionic acid, <i>see</i>	–	8	2511
2-Chloropropylene, <i>see</i>	–	3	2456
<i>alpha</i> -Chloropropylene, <i>see</i>	–	3	1100
2-CHLOROPYRIDINE	–	6.1	2822
CHLOROSILANES, CORROSIVE, FLAMMABLE, N.O.S.	–	8	2986
CHLOROSILANES, CORROSIVE, N.O.S.	–	8	2987
CHLOROSILANES, FLAMMABLE, CORROSIVE, N.O.S.	–	3	2985
CHLOROSILANES, TOXIC, CORROSIVE, FLAMMABLE, N.O.S.	–	6.1	3362
CHLOROSILANES, TOXIC, CORROSIVE, N.O.S.	–	6.1	3361
CHLOROSILANES, WATER-REACTIVE, FLAMMABLE, CORROSIVE, N.O.S.	–	4.3	2988
CHLOROSULPHONIC ACID (with or without sulphur trioxide)	–	8	1754
Chlorosulphuric acid, <i>see</i>	–	6.1	1834
1-CHLORO-1,2,2,2-TETRAFLUOROETHANE	–	2.2	1021
<i>meta</i> -Chlorotoluene, <i>see</i>	P	3	2238
<i>ortho</i> -Chlorotoluene, <i>see</i>	–	3	2238
<i>para</i> -Chlorotoluene, <i>see</i>	P	3	2238
CHLOROTOLUENES	–	3	2238
4-CHLORO- <i>o</i> -TOLUIDINE HYDROCHLORIDE, SOLID	–	6.1	1579
4-CHLORO- <i>o</i> -TOLUIDINE HYDROCHLORIDE SOLUTION	–	6.1	3410
CHLOROTOLUIDINES, LIQUID	–	6.1	3429
CHLOROTOLUIDINES, SOLID	–	6.1	2239
1-CHLORO-2,2,2-TRIFLUOROETHANE	–	2.2	1983
Chlorotrifluoroethylene, stabilized, <i>see</i>	–	2.3	1082
CHLOROTRIFLUOROMETHANE	–	2.2	1022
CHLOROTRIFLUOROMETHANE AND TRIFLUOROMETHANE AZEOTROPIC MIXTURE with approximately 60% chlorotrifluoromethane	–	2.2	2599
2-Chloro-5-trifluoromethylnitrobenzene, <i>see</i>	P	6.1	2307
Chlorovinyl acetate, <i>see</i>	–	6.1	2589
Chlorphacinone, <i>see</i> ORGANOCHLORINE PESTICIDE	–	–	–
Chlorpyrifos, <i>see</i> ORGANOPHOSPHORUS PESTICIDE	P	–	–
Chlorthiophos, <i>see</i> ORGANOPHOSPHORUS PESTICIDE	P	–	–
Chromic acid, solid, <i>see</i>	–	5.1	1463
CHROMIC ACID SOLUTION	–	8	1755
Chromic anhydride, <i>see</i>	–	5.1	1463

Substance, material or article	MP	Class	UN No.
CHROMIC FLUORIDE, SOLID	–	8	1756
CHROMIC FLUORIDE SOLUTION	–	8	1757
Chromic nitrate, <i>see</i>	–	5.1	2720
Chromium(VI) dichloride dioxide, <i>see</i>	–	8	1758
Chromium(III) fluoride, solid, <i>see</i>	–	8	1756
Chromium fluoride, solid, <i>see</i>	–	8	1756
Chromium fluoride solution, <i>see</i>	–	8	1757
CHROMIUM NITRATE	–	5.1	2720
Chromium(III) nitrate, <i>see</i>	–	5.1	2720
CHROMIUM OXYCHLORIDE	–	8	1758
CHROMIUM TRIOXIDE, ANHYDROUS	–	5.1	1463
CHROMOSULPHURIC ACID	–	8	2240
Chromyl chloride, <i>see</i>	–	8	1758
Chrysotile, <i>see</i>	–	9	2590
Cinene, <i>see</i>	P	3	2052
Cinnamene, <i>see</i>	–	3	2055
Cinnamol, <i>see</i>	–	3	2055
CLINICAL WASTE, UNSPECIFIED, N.O.S.	–	6.2	3291
COAL GAS, COMPRESSED	–	2.3	1023
Coal tar, <i>see</i>	P	9	3082
COAL TAR DISTILLATES, FLAMMABLE	–	3	1136
Coal tar naphtha, <i>see</i>	–	3	1268
Coal tar oil, <i>see</i>	–	3	1136
COATING SOLUTION (includes surface treatments or coatings used for industrial purposes such as vehicle under-coating, drum or barrel lining)	–	3	1139
COBALT NAPHTHENATES, POWDER	–	4.1	2001
COBALT RESINATE, PRECIPITATED	–	4.1	1318
Cocculus, <i>see</i>	P	6.1	3172
Coconitrile, <i>see</i>	P	9	3082
Collodion cottons (class 1), <i>see</i> NITROCELLULOSE	–	–	–
Collodion cotton with alcohol, <i>see</i>	–	4.1	2556
Collodion cotton with plasticizing substance, <i>see</i>	–	4.1	2557
Collodion cotton with water, <i>see</i>	–	4.1	2555
Collodion solution, <i>see</i>	–	3	2059
COMPONENTS, EXPLOSIVE TRAIN, N.O.S.	–	1.1B	0461
COMPONENTS, EXPLOSIVE TRAIN, N.O.S.	–	1.2B	0382
COMPONENTS, EXPLOSIVE TRAIN, N.O.S.	–	1.4B	0383
COMPONENTS, EXPLOSIVE TRAIN, N.O.S.	–	1.4S	0384
Composition B, <i>see</i>	–	1.1D	0118
COMPRESSED GAS, FLAMMABLE, N.O.S.	–	2.1	1954
COMPRESSED GAS, N.O.S.	–	2.2	1956
COMPRESSED GAS, OXIDIZING, N.O.S.	–	2.2	3156
COMPRESSED GAS, TOXIC, CORROSIVE, N.O.S.	–	2.3	3304

Index

Substance, material or article	MP	Class	UN No.
COMPRESSED GAS, TOXIC, FLAMMABLE, CORROSIVE, N.O.S.	–	2.3	3305
COMPRESSED GAS, TOXIC, FLAMMABLE, N.O.S.	–	2.3	1953
COMPRESSED GAS, TOXIC, N.O.S.	–	2.3	1955
COMPRESSED GAS, TOXIC, OXIDIZING, CORROSIVE, N.O.S.	–	2.3	3306
COMPRESSED GAS, TOXIC, OXIDIZING, N.O.S.	–	2.3	3303
Container under fumigation, <i>see</i>	–	9	3359
CONTRIVANCES, WATER-ACTIVATED with burster, expelling charge or propelling charge	–	1.2L	0248
CONTRIVANCES, WATER-ACTIVATED with burster, expelling charge or propelling charge	–	1.3L	0249
COPPER ACETOARSENITE	P	6.1	1585
Copper arsenate, <i>see</i>	–	6.1	1557
COPPER ARSENITE	P	6.1	1586
Copper(II) arsenite, <i>see</i>	–	6.1	1586
COPPER BASED PESTICIDE, LIQUID, TOXIC	–	6.1	3010
COPPER BASED PESTICIDE, LIQUID, FLAMMABLE, TOXIC, flashpoint less than 23°C	–	3	2776
COPPER BASED PESTICIDE, LIQUID, TOXIC, FLAMMABLE, flashpoint not less than 23°C	–	6.1	3009
COPPER BASED PESTICIDE, SOLID, TOXIC	–	6.1	2775
COPPER CHLORATE	–	5.1	2721
Copper(II) chlorate, <i>see</i>	–	5.1	2721
COPPER CHLORIDE	P	8	2802
Copper compounds, <i>see</i> COPPER BASED PESTICIDE	–	–	–
COPPER CYANIDE	P	6.1	1587
Copper metal powder, <i>see</i> <b>Note 1</b>	P	–	–
Copper sulphate, anhydrous, hydrates and solutions, <i>see</i> <b>Note 1</b>	P	–	–
COPRA	–	4.2	1363
CORD, DETONATING flexible	–	1.1D	0065
CORD, DETONATING flexible	–	1.4D	0289
CORD, DETONATING metal-clad	–	1.1D	0290
CORD, DETONATING metal-clad	–	1.2D	0102
CORD, DETONATING, MILD EFFECT metal-clad	–	1.4D	0104
CORD, IGNITER	–	1.4G	0066
Cordite, <i>see</i> POWDER, SMOKELESS	–	–	–
CORROSIVE LIQUID, ACIDIC, INORGANIC, N.O.S.	–	8	3264
CORROSIVE LIQUID, ACIDIC, ORGANIC, N.O.S.	–	8	3265
CORROSIVE LIQUID, BASIC, INORGANIC, N.O.S.	–	8	3266
CORROSIVE LIQUID, BASIC, ORGANIC, N.O.S.	–	8	3267
CORROSIVE LIQUID, FLAMMABLE, N.O.S.	–	8	2920
CORROSIVE LIQUID, N.O.S.	–	8	1760
CORROSIVE LIQUID, OXIDIZING, N.O.S.	–	8	3093
CORROSIVE LIQUID, SELF-HEATING, N.O.S.	–	8	3301
CORROSIVE LIQUID, TOXIC, N.O.S.	–	8	2922

Substance, material or article	MP	Class	UN No.
CORROSIVE LIQUID, WATER-REACTIVE, N.O.S.	–	8	3094
CORROSIVE SOLID, ACIDIC, INORGANIC, N.O.S.	–	8	3260
CORROSIVE SOLID, ACIDIC, ORGANIC, N.O.S.	–	8	3261
CORROSIVE SOLID, BASIC, INORGANIC, N.O.S.	–	8	3262
CORROSIVE SOLID, BASIC, ORGANIC, N.O.S.	–	8	3263
CORROSIVE SOLID, FLAMMABLE, N.O.S.	–	8	2921
CORROSIVE SOLID, N.O.S.	–	8	1759
CORROSIVE SOLID, OXIDIZING, N.O.S.	–	8	3084
CORROSIVE SOLID, SELF-HEATING, N.O.S.	–	8	3095
CORROSIVE SOLID, TOXIC, N.O.S.	–	8	2923
CORROSIVE SOLID, WATER-REACTIVE, N.O.S.	–	8	3096
Cosmetics, <i>see</i>	–	3	1266
Cotton, dry, <i>see</i>	–	4.1	3360
COTTON WASTE, OILY	–	4.2	1364
COTTON, WET	–	4.2	1365
Coumachlor, <i>see</i> COUMARIN DERIVATIVE PESTICIDE	P	–	–
Coumafuryl, <i>see</i> COUMARIN DERIVATIVE PESTICIDE	–	–	–
Coumaphos, <i>see</i> COUMARIN DERIVATIVE PESTICIDE	P	–	–
COUMARIN DERIVATIVE PESTICIDE, LIQUID, FLAMMABLE, TOXIC flashpoint less than 23°C	–	3	3024
COUMARIN DERIVATIVE PESTICIDE, LIQUID, TOXIC	–	6.1	3026
COUMARIN DERIVATIVE PESTICIDE, LIQUID, TOXIC, FLAMMABLE flashpoint not less than 23°C	–	6.1	3025
COUMARIN DERIVATIVE PESTICIDE, SOLID, TOXIC	–	6.1	3027
Coumatetralyl, <i>see</i> COUMARIN DERIVATIVE PESTICIDE	–	–	–
Creosote, <i>see</i>	P	9	3082
Creosote salts, <i>see</i>	–	4.1	1334
CRESOLS, LIQUID	–	6.1	2076
CRESOLS, SOLID	–	6.1	3455
Cresyl diphenyl phosphate, <i>see</i>	P	9	3082
CRESYLIC ACID	–	6.1	2022
Crimidine, <i>see</i> ORGANOCHLORINE PESTICIDE	–	–	–
Crocidolite, <i>see</i>	–	9	2212
CROTONALDEHYDE	–	6.1	1143
CROTONALDEHYDE, STABILIZED	P	6.1	1143
CROTONIC ACID, LIQUID	–	8	3472
CROTONIC ACID, SOLID	–	8	2823
Crotonic aldehyde, stabilized, <i>see</i>	P	6.1	1143
CROTONYLENE	–	3	1144
Crotoxyphos, <i>see</i> ORGANOPHOSPHORUS PESTICIDE	P	–	–
Crude naphtha, <i>see</i>	–	3	1268
Crufomate, <i>see</i> ORGANOPHOSPHORUS PESTICIDE	–	–	–
Cumene, <i>see</i>	–	3	1918
Cumyl hydroperoxide (concentration ≤90%, with diluent Type A), <i>see</i>	–	5.2	3109

Index

Substance, material or article	MP	Class	UN No.
Cumyl hydroperoxide (concentration >90–98%, with diluent Type A), see	–	5.2	3107
Cumyl peroxyneodecanoate (concentration ≤52% as a stable dispersion in water), see	–	5.2	3119
Cumyl peroxyneodecanoate (concentration ≤77%, with diluent Type B), see	–	5.2	3115
Cumyl peroxyneodecanoate (concentration ≤87%, with diluent Type A), see	–	5.2	3115
Cumyl peroxyneoheptanoate (concentration ≤77%, with diluent Type A), see	–	5.2	3115
Cumyl peroxyvalerate (concentration ≤77%, with diluent Type B), see	–	5.2	3115
Cupric arsenite, see	P	6.1	1586
Cupric chlorate, see	–	5.1	2721
Cupric chloride, see	P	8	2802
Cupric cyanide, see	P	6.1	1587
Cupric sulphate, see Note 1	P	–	–
CUPRIETHYLENEDIAMINE SOLUTION	P	8	1761
Cuprous chloride, see	P	8	2802
Cut-backs, see	–	3	1999
CUTTERS, CABLE, EXPLOSIVE	–	1.4S	0070
Cyanazine, see TRIAZINE PESTICIDE	–	–	–
Cyanide mixture, inorganic, solid, N.O.S., see	P	6.1	1588
CYANIDES, INORGANIC, SOLID, N.O.S.	P	6.1	1588
CYANIDE SOLUTION, N.O.S.	P	6.1	1935
Cyanides, organic, flammable, toxic, N.O.S., see	–	3	3273
Cyanides, organic, toxic, flammable, N.O.S., see	–	6.1	3275
Cyanides, organic, toxic, N.O.S., see	–	6.1	3276
Cyanoacetonitrile, see	–	6.1	2647
CYANOGEN	–	2.3	1026
CYANOGEN BROMIDE	P	6.1	1889
CYANOGEN CHLORIDE, STABILIZED	P	2.3	1589
Cyanophos, see ORGANOPHOSPHORUS PESTICIDE	P	–	–
CYANURIC CHLORIDE	–	8	2670
CYCLOBUTANE	–	2.1	2601
CYCLOBUTYL CHLOROFORMATE	–	6.1	2744
1,5,9-CYCLODODECATRIENE	P	6.1	2518
CYCLOHEPTANE	–	3	2241
CYCLOHEPTATRIENE	–	3	2603
1,3,5-Cycloheptatriene, see	–	3	2603
CYCLOHEPTENE	–	3	2242
1,4-Cyclohexadienedione, see	–	6.1	2587
CYCLOHEXANE	–	3	1145
CYCLOHEXANETHIOL	–	3	3054
CYCLOHEXANONE	–	3	1915

Substance, material or article	MP	Class	UN No.
Cyclohexanone peroxide(s) (concentration $\leq$ 32%, with inert solid) (exempt)	-	-	-
Cyclohexanone peroxide(s) (concentration $\leq$ 72%, as a paste, with diluent Type A, with or without water, available oxygen $\leq$ 9%), see	-	5.2	3106
Cyclohexanone peroxide(s) (concentration $\leq$ 72%, with diluent Type A, available oxygen $\leq$ 9%), see	-	5.2	3105
Cyclohexanone peroxide(s) (concentration $\leq$ 91%, with water), see	-	5.2	3104
CYCLOHEXENE	-	3	2256
CYCLOHEXENYLTRICHLOROSILANE	-	8	1762
Cycloheximide, see PESTICIDE, N.O.S.	-	-	-
CYCLOHEXYL ACETATE	-	3	2243
CYCLOHEXYLAMINE	-	8	2357
CYCLOHEXYL ISOCYANATE	-	6.1	2488
CYCLOHEXYL MERCAPTAN	-	3	3054
CYCLOHEXYLTRICHLOROSILANE	-	8	1763
CYCLONITE AND CYCLOTETRAMETHYLENETETRANITRAMINE MIXTURE, DESENSITIZED with not less than 10% phlegmatizer, by mass	-	1.1D	0391
CYCLONITE AND CYCLOTETRAMETHYLENETETRANITRAMINE MIXTURE, WETTED with not less than 15% water, by mass	-	1.1D	0391
CYCLONITE AND HMX MIXTURE, DESENSITIZED with not less than 10% phlegmatizer, by mass	-	1.1D	0391
CYCLONITE AND HMX MIXTURE, WETTED with not less than 15% water, by mass	-	1.1D	0391
CYCLONITE AND OCTOGEN MIXTURE, DESENSITIZED with not less than 10% phlegmatizer, by mass	-	1.1D	0391
CYCLONITE AND OCTOGEN MIXTURE, WETTED with not less than 15% water, by mass	-	1.1D	0391
CYCLONITE, DESENSITIZED	-	1.1D	0483
CYCLONITE, WETTED with not less than 15% water, by mass	-	1.1D	0072
CYCLOOCTADIENEPHOSPHINES	-	4.2	2940
CYCLOOCTADIENES	-	3	2520
CYCLOOCTATETRAENE	-	3	2358
CYCLOPENTANE	-	3	1146
CYCLOPENTANOL	-	3	2244
CYCLOPENTANONE	-	3	2245
CYCLOPENTENE	-	3	2246
CYCLOPROPANE	-	2.1	1027
CYCLOTETRAMETHYLENETETRANITRAMINE, DESENSITIZED	-	1.1D	0484
CYCLOTETRAMETHYLENETETRANITRAMINE, WETTED with not less than 15% water, by mass	-	1.1D	0226
CYCLOTRIMETHYLENETRINITRAMINE AND CYCLOTETRAMETHYLENETETRANITRAMINE MIXTURE, DESENSITIZED with not less than 10% phlegmatizer, by mass	-	1.1D	0391
CYCLOTRIMETHYLENETRINITRAMINE AND CYCLOTETRAMETHYLENETETRANITRAMINE MIXTURE, WETTED with not less than 15% water, by mass	-	1.1D	0391



Index

Substance, material or article	MP	Class	UN No.
CYCLOTRIMETHYLENETRINITRAMINE AND HMX MIXTURE, DESENSITIZED with not less than 10% phlegmatizer, by mass	–	1.1D	0391
CYCLOTRIMETHYLENETRINITRAMINE AND HMX MIXTURE, WETTED with not less than 15% water, by mass	–	1.1D	0391
CYCLOTRIMETHYLENETRINITRAMINE AND OCTOGEN MIXTURE, DESENSITIZED with not less than 10% phlegmatizer, by mass	–	1.1D	0391
CYCLOTRIMETHYLENETRINITRAMINE AND OCTOGEN MIXTURE, WETTED with not less than 15% water, by mass	–	1.1D	0391
CYCLOTRIMETHYLENETRINITRAMINE, DESENSITIZED	–	1.1D	0483
CYCLOTRIMETHYLENETRINITRAMINE, WETTED with not less than 15% water, by mass	–	1.1D	0072
Cyhexatin, <i>see</i> ORGANOTIN PESTICIDE,	P	–	–
CYMENES	P	3	2046
Cymol, <i>see</i>	P	3	2046
Cypermethrin, <i>see</i> PYRETHROID PESTICIDE	P	–	–
2,4-D, <i>see</i> PHENOXYACETIC ACID DERIVATIVE PESTICIDE	–	–	–
DANGEROUS GOODS IN APPARATUS	–	9	3363
DANGEROUS GOODS IN MACHINERY	–	9	3363
Dazomet, <i>see</i> PESTICIDE, N.O.S.	–	–	–
2,4-DB, <i>see</i> PHENOXYACETIC ACID DERIVATIVE PESTICIDE	–	–	–
DDT, <i>see</i> ORGANOCHLORINE PESTICIDE	P	–	–
Deanol, <i>see</i>	–	8	2051
DECABORANE	–	4.1	1868
DECAHYDRONAPHTHALENES	–	3	1147
Decaldehyde, <i>see</i>	P	9	3082
Decalin, <i>see</i>	–	3	1147
(3R-3R,5aS,6S,8aS,9R,10R,12S,12aR**)-DECAHYDRO-10-METHOXY-3,6,9-TRIMETHYL-3,12-EPOXY-12H-PYRANO 4,3-j-1,2-BENZODIOXEPIN)	–	5.2	3106
n-DECANE	–	3	2247
Decyl acrylate, <i>see</i>	P	9	3082
Decyloxytetrahydrothiophene dioxide, <i>see</i> Note 1	P	–	–
DEF, <i>see</i> ORGANOPHOSPHORUS PESTICIDE	P	–	–
DEFLAGRATING METAL SALTS OF AROMATIC NITRO-DERIVATIVES, N.O.S.	–	1.3C	0132
Demephion, <i>see</i> ORGANOPHOSPHORUS PESTICIDE	–	–	–
Demeton, <i>see</i> ORGANOPHOSPHORUS PESTICIDE	–	–	–
Demeton-O, <i>see</i> ORGANOPHOSPHORUS PESTICIDE	–	–	–
Demeton-O-methyl, thiono isomer, <i>see</i> ORGANOPHOSPHORUS PESTICIDE	–	–	–
Demeton-S-methyl, <i>see</i> ORGANOPHOSPHORUS PESTICIDE	–	–	–
Demeton-S-methylsulphoxyd, <i>see</i> ORGANOPHOSPHORUS PESTICIDE	–	–	–
Depth charges, <i>see</i>	–	1.1D	0056
DESENSITIZED EXPLOSIVE, LIQUID, N.O.S.	–	3	3379

Substance, material or article	MP	Class	UN No.
DESENSITIZED EXPLOSIVE, SOLID, N.O.S.	–	4.1	3380
Desmediphan, <i>see</i> Note 1	P	–	–
Detonating relays, <i>see</i> DETONATOR ASSEMBLIES, NON-ELECTRIC, for blasting <i>or see</i> DETONATORS, NON-ELECTRIC for blasting	–	–	–
DETONATOR ASSEMBLIES, NON-ELECTRIC for blasting	–	1.1B	0360
DETONATOR ASSEMBLIES, NON-ELECTRIC for blasting	–	1.4B	0361
DETONATOR ASSEMBLIES, NON-ELECTRIC for blasting	–	1.4S	0500
DETONATORS, ELECTRIC for blasting	–	1.1B	0030
DETONATORS, ELECTRIC for blasting	–	1.4B	0255
DETONATORS, ELECTRIC for blasting	–	1.4S	0456
DETONATORS FOR AMMUNITION	–	1.1B	0073
DETONATORS FOR AMMUNITION	–	1.2B	0364
DETONATORS FOR AMMUNITION	–	1.4B	0365
DETONATORS FOR AMMUNITION	–	1.4S	0366
DETONATORS, NON-ELECTRIC for blasting	–	1.1B	0029
DETONATORS, NON-ELECTRIC for blasting	–	1.4B	0267
DETONATORS, NON-ELECTRIC for blasting	–	1.4S	0455
DEUTERIUM, COMPRESSED	–	2.1	1957
DEVICES, SMALL, HYDROCARBON GAS POWERED	–	2.1	3150
Diacetone, <i>see</i>	–	3	1148
DIACETONE ALCOHOL	–	3	1148
Diacetone alcohol peroxides (concentration ≤57%, with diluent Type B and water, hydrogen peroxide ≤9%, available oxygen ≤10%), <i>see</i>	–	5.2	3115
Diacetyl, <i>see</i>	–	3	2346
Diacetyl peroxide (concentration ≤27%, with diluent Type B), <i>see</i>	–	5.2	3115
Dialifos, <i>see</i> ORGANOPHOSPHORUS PESTICIDE	P	–	–
Diallate, <i>see</i> PESTICIDE, N.O.S.	P	–	–
DIALLYLAMINE	–	3	2359
DIALLYL ETHER	–	3	2360
Diamine, aqueous solution, <i>see</i>	–	6.1	3293
Diaminobenzenes ( <i>ortho</i> -; <i>meta</i> -; <i>para</i> -), <i>see</i>	–	6.1	1673
4,4'-DIAMINODIPHENYLMETHANE	P	6.1	2651
1,2-Diaminoethane, <i>see</i>	–	8	1604
1,6-Diaminohexane, solid, <i>see</i>	–	8	2280
1,6-Diaminohexane solution, <i>see</i>	–	8	1783
Diaminopropylamine, <i>see</i>	–	8	2269
DI- <i>n</i> -AMYLAMINE	–	3	2841
Di- <i>tert</i> -amyl peroxide (concentration ≤100%), <i>see</i>	–	5.2	3107
2,2-Di-( <i>tert</i> -amylperoxy)butane (concentration ≤57%, with diluent Type A)	–	5.2	3105
1,1-Di-( <i>tert</i> -amylperoxy)cyclohexane (concentration ≤82%, with diluent Type A), <i>see</i>	–	5.2	3103
Diazinon, <i>see</i> ORGANOPHOSPHORUS PESTICIDE	P	–	–

Index

Substance, material or article	MP	Class	UN No.
DIAZODINITROPHENOL, WETTED with not less than 40% water or mixture of alcohol and water, by mass	–	1.1A	0074
2-Diazo-1-naphthol-4-sulphonic acid ester (concentration 100%), see	–	4.1	3226
2-Diazo-1-naphthol-5-sulphonic acid ester (concentration 100%), see	–	4.1	3226
2-Diazo-1-naphthol-4-sulphonyl chloride (concentration 100%), see	–	4.1	3222
2-Diazo-1-naphthol-5-sulphonyl chloride (concentration 100%), see	–	4.1	3222
Dibenzopyridine, see	–	6.1	2713
Dibenzoyl peroxide (concentration ≤35%, with inert solid) (exempt)	–	–	–
Dibenzoyl peroxide (concentration >35–52%, with inert solid), see	–	5.2	3106
Dibenzoyl peroxide (concentration >36–42%, with diluent Type A and water), see	–	5.2	3107
Dibenzoyl peroxide (concentration ≤42% as a stable dispersion in water), see	–	5.2	3109
Dibenzoyl peroxide (concentration >51–100%, with inert solid), see	–	5.2	3102
Dibenzoyl peroxide (concentration ≤52%, as a paste, with diluent Type A, with or without water), see	–	5.2	3108
Dibenzoyl peroxide (concentration >52–62%, as a paste, with diluent Type A, with or without water), see	–	5.2	3106
Dibenzoyl peroxide (concentration ≤56.5% as a paste, with water), see	–	5.2	3108
Dibenzoyl peroxide (concentration ≤62%, with inert solid and water), see	–	5.2	3106
Dibenzoyl peroxide (concentration ≤77%, with water), see	–	5.2	3104
Dibenzoyl peroxide (concentration >77–94%, with water), see	–	5.2	3102
DIBENZYL DICHLOROSILANE	–	8	2434
DIBORANE	–	2.3	1911
1,3-Dibromobenzene, see	P	9	3082
1,2-DIBROMOBUTAN-3-ONE	–	6.1	2648
1,2-Dibromo-3-chloropropane (pesticides), see	–	6.1	2872
DIBROMOCHLOROPROPANES	–	6.1	2872
DIBROMOCHLOROPROPANES	–	6.1	2872
DIBROMODIFLUOROMETHANE	–	9	1941
1,2-Dibromoethane, see	–	6.1	1605
DIBROMOMETHANE	–	6.1	2664
2,5-Dibutoxy-4-(4-morpholinyl)benzenediazonium tetrachlorozincate (2:1) (concentration 100%), see	–	4.1	3228
DI- <i>n</i> -BUTYLAMINE	–	8	2248
Dibutylaminoethanol, see	–	6.1	2873
2-Dibutylaminoethanol, see	–	6.1	2873
DI-BUTYLAMINOETHANOL	–	6.1	2873
1,4-Di- <i>tert</i> -butylbenzene, see	P	9	3077
Di-(4- <i>tert</i> -butylcyclohexyl) peroxydicarbonate (concentration ≤42%, as a stable dispersion in water), see	–	5.2	3119
Di-(4- <i>tert</i> -butylcyclohexyl) peroxydicarbonate (concentration ≤100%), see	–	5.2	3114
DIBUTYL ETHERS	–	3	1149
Di- <i>normal</i> -butyl ketone, see	P	3	1224

Substance, material or article	MP	Class	UN No.
Di- <i>tert</i> -butyl peroxide (concentration $\leq$ 52%, with diluent Type B), see	–	5.2	3109
Di- <i>tert</i> -butyl peroxide (concentration >52–100%), see	–	5.2	3107
Di- <i>tert</i> -butyl peroxyazolate (concentration $\leq$ 52%, with diluent Type A), see	–	5.2	3105
2,2-Di-( <i>tert</i> -butylperoxy)butane (concentration $\leq$ 52%, with diluent Type A), see	–	5.2	3103
1,6-Di-( <i>tert</i> -butylperoxycarbonyloxy)hexane (concentration $\leq$ 72%, with diluent Type A), see	–	5.2	3103
1,1-Di-( <i>tert</i> -butylperoxy)cyclohexane (concentration $\leq$ 13%, with diluents Type A and B), see	–	5.2	3109
1,1-Di-( <i>tert</i> -butylperoxy)cyclohexane (concentration $\leq$ 27%, with diluent Type A), see	–	5.2	3107
1,1-Di-( <i>tert</i> -butylperoxy)cyclohexane (concentration $\leq$ 42%, with diluent Type A), see	–	5.2	3109
1,1-Di-( <i>tert</i> -butylperoxy)cyclohexane (concentration $\leq$ 42%, with diluent Type A and inert solid), see	–	5.2	3106
1,1-Di-( <i>tert</i> -butylperoxy)cyclohexane (concentration >42–52%, with diluent Type A)	–	5.2	3105
1,1-Di-( <i>tert</i> -butylperoxy)cyclohexane (concentration >52–80%, with diluent Type A), see	–	5.2	3103
1,1-Di-( <i>tert</i> -butylperoxy)cyclohexane (concentration $\leq$ 72%, with diluent Type B)	–	5.2	3103
1,1-Di-( <i>tert</i> -butylperoxy)cyclohexane (concentration >80–100%), see	–	5.2	3101
1,1-Di-( <i>tert</i> -butylperoxy)cyclohexane + <i>tert</i> -butyl peroxy-2-ethylhexanoate (concentration $\leq$ 43% + $\leq$ 16%, with diluent Type A)	–	5.2	3105
Di- <i>n</i> -butyl peroxydicarbonate (concentration $\leq$ 27%, with diluent Type B), see	–	5.2	3117
Di- <i>n</i> -butyl peroxydicarbonate (concentration >27–52%, with diluent Type B), see	–	5.2	3115
Di- <i>n</i> -butyl peroxydicarbonate (concentration $\leq$ 42% as a stable dispersion in water (frozen)), see	–	5.2	3118
Di- <i>sec</i> -butyl peroxydicarbonate (concentration $\leq$ 52%, with diluent Type B), see	–	5.2	3115
Di- <i>sec</i> -butyl peroxydicarbonate (concentration >52–100%), see	–	5.2	3113
Di-(2- <i>tert</i> -butylperoxyisopropyl)benzene(s) (concentration $\leq$ 42%, with inert solid) (exempt)	–	–	–
Di-( <i>tert</i> -butylperoxyisopropyl)benzene(s) (concentration >42–100%, with inert solid), see	–	5.2	3106
Di-( <i>tert</i> -butylperoxy) phthalate (concentration $\leq$ 42%, with diluent Type A), see	–	5.2	3107
Di-( <i>tert</i> -butylperoxy) phthalate (concentration >42–52%, with diluent Type A), see	–	5.2	3105
Di-( <i>tert</i> -butylperoxy) phthalate (concentration $\leq$ 52%, as a paste with diluent Type A, with or without water), see	–	5.2	3106
2,2-Di-( <i>tert</i> -butylperoxy)propane (concentration $\leq$ 42%, with diluent Type A, with inert solid), see	–	5.2	3106
2,2-Di-( <i>tert</i> -butylperoxy)propane (concentration $\leq$ 52% with diluent Type A), see	–	5.2	3105
1,1-Di-( <i>tert</i> -butylperoxy)-3,3,5-trimethylcyclohexane (concentration $\leq$ 32%, with diluents Type A and B), see	–	5.2	3107

Index

Substance, material or article	MP	Class	UN No.
1,1-Di-( <i>tert</i> -butylperoxy)-3,3,5-trimethylcyclohexane (concentration ≤57%, with diluent Type A), <i>see</i>	–	5.2	3107
1,1-Di-( <i>tert</i> -butylperoxy)-3,3,5-trimethylcyclohexane (concentration ≤57%, with inert solid), <i>see</i>	–	5.2	3110
1,1-Di-( <i>tert</i> -butylperoxy)-3,3,5-trimethylcyclohexane (concentration >57–90%, with diluent Type A), <i>see</i>	–	5.2	3103
1,1-Di-( <i>tert</i> -butylperoxy)-3,3,5-trimethylcyclohexane (concentration ≤77%, with diluent Type B), <i>see</i>	–	5.2	3103
1,1-Di-( <i>tert</i> -butylperoxy)-3,3,5-trimethylcyclohexane (concentration ≤90%, with diluent Type B)	–	5.2	3103
1,1-Di-( <i>tert</i> -butylperoxy)-3,3,5-trimethylcyclohexane (concentration >90–100%), <i>see</i>	–	5.2	3101
2,4-Di- <i>tert</i> -butylphenol, <i>see</i> <b>Note 1</b>	–	–	–
2,6-Di- <i>tert</i> -butylphenol, <i>see</i> <b>Note 1</b>	–	–	–
Di- <i>n</i> -butyl phthalate, <i>see</i>	P	9	3082
Dicetyl peroxydicarbonate (concentration ≤42% as a stable dispersion in water), <i>see</i>	–	5.2	3119
Dicetyl peroxydicarbonate (concentration ≤100%), <i>see</i>	–	5.2	3116
Dichlofenthion, <i>see</i> ORGANOPHOSPHORUS PESTICIDE	P	–	–
1,1-DICHLORO-1-NITROETHANE	–	6.1	2650
DICHLOROACETIC ACID	–	8	1764
1,3-DICHLOROACETONE	–	6.1	2649
DICHLOROACETYL CHLORIDE	–	8	1765
DICHLOROANILINES, LIQUID	P	6.1	1590
DICHLOROANILINES, SOLID	P	6.1	3442
1,2-Dichlorobenzene, <i>see</i>	–	6.1	1591
1,3-Dichlorobenzene, <i>see</i>	P	6.1	2810
1,4-Dichlorobenzene, <i>see</i>	P	9	3082
<i>meta</i> -Dichlorobenzene, <i>see</i>	P	6.1	2810
<i>o</i> -DICHLOROBENZENE	–	6.1	1591
<i>para</i> -Dichlorobenzene, <i>see</i>	P	9	3082
Di-(4-chlorobenzoyl) peroxide (concentration ≤32%, with inert solid) ( <i>exempt</i> )	–	–	–
Di-4-chlorobenzoyl peroxide (concentration ≤52%, as a paste, with diluent Type A, with or without water), <i>see</i>	–	5.2	3106
Di-4-chlorobenzoyl peroxide (concentration ≤77%, with water), <i>see</i>	–	5.2	3102
2,2'-DICHLORODIETHYL ETHER	–	6.1	1916
DICHLORODIFLUOROMETHANE	–	2.2	1028
DICHLORODIFLUOROMETHANE AND DIFLUOROETHANE AZEOTROPIC MIXTURE with approximately 74% dichloro-difluoromethane	–	2.2	2602
Dichlorodifluoromethane and ethylene oxide mixture, <i>see</i>	–	2.2	3070
DICHLORODIMETHYL ETHER, SYMMETRICAL	–	6.1	2249
1,1-DICHLOROETHANE	–	3	2362
1,2-Dichloroethane, <i>see</i>	–	3	1184
1,1-Dichloroethylene, stabilized, <i>see</i>	P	3	1303

Substance, material or article	MP	Class	UN No.
1,2-DICHLOROETHYLENE	–	3	1150
Di-(2-chloroethyl) ether, <i>see</i>	–	6.1	1916
DICHLOROFLUOROMETHANE	–	2.2	1029
1,6-Dichlorohexane, <i>see</i>	P	9	3082
<i>alpha</i> -Dichlorohydrin, <i>see</i>	–	6.1	2750
DICHLOROISOCYANURIC ACID, DRY	–	5.1	2465
DICHLOROISOCYANURIC ACID, SALTS	–	5.1	2465
Dichloroisopropyl alcohol, <i>see</i>	–	6.1	2750
DICHLOROISOPROPYL ETHER	–	6.1	2490
DICHLOROMETHANE	–	6.1	1593
DICHLOROPENTANES	–	3	1152
Dichlorophenols, liquid, <i>see</i>	–	6.1	2021
Dichlorophenols, solid, <i>see</i>	–	6.1	2020
DICHLOROPHENYL ISOCYANATES	–	6.1	2250
DICHLOROPHENYLTRICHLOROSILANE	P	8	1766
1,1-Dichloropropane, <i>see</i>	–	3	1993
1,2-DICHLOROPROPANE	–	3	1279
1,3-Dichloropropane, <i>see</i>	–	3	1993
1,3-DICHLOROPROPANOL-2	–	6.1	2750
1,3-Dichloro-2-propanone, <i>see</i>	–	6.1	2649
DICHLOROPROPENES	–	3	2047
DICHLOROSILANE	–	2.3	2189
1,2-DICHLORO-1,1,2,2-TETRAFLUOROETHANE	–	2.2	1958
Dichloro-s-triazine-2,4,6-trione	–	5.1	2465
Dichlorvos, <i>see</i> ORGANOPHOSPHORUS PESTICIDE	P	–	–
Diclofop-methyl, <i>see</i> Note 1	P	–	–
Dicoumarol, <i>see</i> COUMARIN DERIVATIVE PESTICIDE	–	–	–
Dicrotophos, <i>see</i> ORGANOPHOSPHORUS PESTICIDE	P	–	–
Dicumyl peroxide (concentration ≤52%, with inert solid) ( <i>exempt</i> )	–	–	–
Dicumyl peroxide (concentration >52–100%), <i>see</i>	–	5.2	3110
1,4-Dicyanobutane, <i>see</i>	–	6.1	2205
Dicyanogen, <i>see</i>	–	2.3	1026
Dicycloheptadiene, stabilized, <i>see</i>	–	3	2251
DICYCLOHEXYLAMINE	–	8	2565
Dicyclohexylamine nitrite, <i>see</i>	–	4.1	2687
DICYCLOHEXYLAMMONIUM NITRITE	–	4.1	2687
Dicyclohexyl peroxydicarbonate (concentration ≤42% as a stable dispersion in water), <i>see</i>	–	5.2	3119
Dicyclohexyl peroxydicarbonate (concentration ≤91%, with water), <i>see</i>	–	5.2	3114
Dicyclohexyl peroxydicarbonate (concentration >91–100%), <i>see</i>	–	5.2	3112
DICYCLOPENTADIENE	–	3	2048
Didecanoyl peroxide (concentration ≤100%), <i>see</i>	–	5.2	3114
2,2-Di-(4,4-di-( <i>tert</i> -butylperoxy)cyclohexyl)propane (concentration ≤22%, with water), <i>see</i>	–	5.2	3107

Index

Substance, material or article	MP	Class	UN No.
2,2-Di-(4,4-di-( <i>tert</i> -butylperoxy)cyclohexyl)propane (concentration ≤42%, with inert solid), see	–	5.2	3106
Di-2,4-dichlorobenzoyl peroxide (concentration ≤52%, as a paste)	–	5.2	3118
Di-(2,4-dichlorobenzoyl) peroxide (concentration ≤52%, as a paste, with silicon oil), see	–	5.2	3106
Di-(2,4-dichlorobenzoyl) peroxide (concentration ≤77%, with water), see	–	5.2	3102
1,2-DI(DIMETHYLAMINO)ETHANE	–	3	2372
DIDYMIUM NITRATE	–	5.1	1465
Dieldrin, see ORGANOCHLORINE PESTICIDE	P	–	–
DIESEL FUEL	–	3	1202
1,1-Diethoxyethane, see	–	3	1088
1,2-Diethoxyethane, see	–	3	1153
Di-(2-ethoxyethyl) peroxydicarbonate (concentration ≤52%, with diluent Type B), see	–	5.2	3115
DIETHOXYMETHANE	–	3	2373
2,5-Diethoxy-4-morpholinobenzenediazonium tetrafluoroborate (concentration 100%), see	–	4.1	3236
2,5-Diethoxy-4-morpholinobenzenediazonium zinc chloride (concentration 66%), see	–	4.1	3236
2,5-Diethoxy-4-morpholinobenzenediazonium zinc chloride (concentration 67–100%), see	–	4.1	3236
2,5-Diethoxy-4-(4-morpholinyl)benzenediazonium sulphate (concentration 100%), see	–	4.1	3226
2,5-Diethoxy-4-(phenylsulphonyl)benzenediazonium zinc chloride (concentration 67%), see	–	4.1	3236
3,3-DIETHOXYPROPENE	–	3	2374
Diethylacetaldehyde, see	–	3	1178
DIETHYLAMINE	–	3	1154
1-Diethylamino-4-aminopentane, see	–	6.1	2946
Diethylaminoethanol, see	–	8	2686
2-DIETHYLAMINOETHANOL	–	8	2686
3-DIETHYLAMINOPROPYLAMINE	–	3	2684
<i>N,N</i> -DIETHYLANILINE	–	6.1	2432
DIETHYLBENZENES	–	3	2049
Diethyl carbinol, see	–	3	1105
DIETHYL CARBONATE	–	3	2366
DIETHYLDICHLOROSILANE	–	8	1767
Diethylenediamine, see	–	8	2579
Diethylenediamine, solid, see	–	8	2579
1,4-Diethylene dioxide, see	–	3	1165
Diethyleneglycol bis(allyl carbonate) + di-isopropyl peroxydicarbonate (concentration ≥88% + ≤12%), see	–	4.1	3237
DIETHYLENGLYCOL DINITRATE, DESENSITIZED with not less than 25% non-volatile water-insoluble phlegmatizer, by mass	–	1.1D	0075
Diethylene oxide, see	–	3	1165

Substance, material or article	MP	Class	UN No.
DIETHYLENTRIAMINE	–	8	2079
<i>N,N</i> -Diethylethanolamine, <i>see</i>	–	8	2686
DIETHYL ETHER	–	3	1155
<i>N,N</i> -DIETHYLETHYLENEDIAMINE	–	8	2685
Diethyl formal, <i>see</i>	–	3	2373
Di-(2-ethylhexyl) peroxydicarbonate (concentration $\leq 52\%$ , as a stable dispersion in water (frozen)), <i>see</i>	–	5.2	3120
Di-(2-ethylhexyl) peroxydicarbonate (concentration $\leq 62\%$ , as a stable dispersion in water), <i>see</i>	–	5.2	3119
Di-(2-ethylhexyl) peroxydicarbonate (concentration $\leq 77\%$ , with diluent Type B), <i>see</i>	–	5.2	3115
Di-(2-ethylhexyl) peroxydicarbonate (concentration $> 77-100\%$ ), <i>see</i>	–	5.2	3113
Di-(2-ethylhexyl)phosphoric acid, <i>see</i>	–	8	1902
DIETHYL KETONE	–	3	1156
Diethyl oxalate, <i>see</i>	–	6.1	2525
<i>N,N</i> -Diethyl-1,3-propanediamine, <i>see</i>	–	3	2684
DIETHYL SULPHATE	–	6.1	1594
DIETHYL SULPHIDE	–	3	2375
DIETHYLTHIOPHOSPHORYL CHLORIDE	–	8	2751
Diethylzinc, <i>see</i>	–	4.2	3394
Difenacoum, <i>see</i> COUMARIN DERIVATIVE PESTICIDE	–	–	–
Difenzoquat, <i>see</i> PESTICIDE, N.O.S.	–	–	–
2,4-Difluoroaniline, <i>see</i>	–	6.1	2941
Difluorochloroethane, <i>see</i>	–	2.1	2517
Difluorodibromomethane, <i>see</i>	–	9	1941
1,1-DIFLUOROETHANE	–	2.1	1030
Difluoroethane and dichlorodifluoromethane, azeotropic mixture with approximately 74% dichlorodifluoromethane, <i>see</i> DICHLORODIFLUOROMETHANE AND DIFLUOROETHANE, AZEOTROPIC MIXTURE	–	–	–
1,1-DIFLUOROETHYLENE	–	2.1	1959
DIFLUOROMETHANE	–	2.1	3252
DIFLUOROPHOSPHORIC ACID, ANHYDROUS	–	8	1768
2,2-Dihydroperoxypropane (concentration $\leq 27\%$ , with inert solid), <i>see</i>	–	5.2	3102
2,3-DIHYDROPYRAN	–	3	2376
<i>meta</i> -Dihydroxybenzene, <i>see</i>	–	6.1	2876
Di-(1-hydroxycyclohexyl) peroxide (concentration $\leq 100\%$ ), <i>see</i>	–	5.2	3106
DIISOBUTYLAMINE	–	3	2361
DIISOBUTYLENES, ISOMERIC COMPOUNDS	–	3	2050
DIISOBUTYL KETONE	–	3	1157
Diisobutryl peroxide (concentration $\leq 32\%$ , with diluent Type B), <i>see</i>	–	5.2	3115
Diisobutryl peroxide (concentration $> 32-52\%$ , with diluent Type A), <i>see</i>	–	5.2	3111
DIISOCTYL ACID PHOSPHATE	–	8	1902
Diisopropyl, <i>see</i>	–	3	2457



Index

Substance, material or article	MP	Class	UN No.
DIISOPROPYLAMINE	–	3	1158
Diisopropylbenzene dihydroperoxide (concentration ≤82%, with diluent Type A and water), see	–	5.2	3106
Diisopropylbenzenes, see	P	9	3082
DIISOPROPYL ETHER	–	3	1159
Diisopropylnaphthalenes, mixed isomers, see	P	9	3082
Diisopropyl peroxydicarbonate (concentration ≤32%, with diluent Type A), see	–	5.2	3115
Diisopropyl peroxydicarbonate (concentration ≤52%, with diluent Type B), see	–	5.2	3115
Diisopropyl peroxydicarbonate (concentration >52–100%), see	–	5.2	3112
DIKETENE, STABILIZED	–	6.1	2521
Dilauroyl peroxide (concentration ≤42%, as a stable dispersion in water), see	–	5.2	3109
Dilauroyl peroxide (concentration ≤100%), see	–	5.2	3106
Dimefox, see ORGANOPHOSPHORUS PESTICIDE	–	–	–
Dimetan, see CARBAMATE PESTICIDE	–	–	–
Dimethoate, see ORGANOPHOSPHORUS PESTICIDE	P	–	–
Di-(3-methoxybutyl) peroxydicarbonate (concentration ≤52%, with diluent Type B), see	–	5.2	3115
1,1-DIMETHOXYETHANE	–	3	2377
1,2-DIMETHOXYETHANE	–	3	2252
Dimethoxymethane, see	–	3	1234
2,5-Dimethoxy-4-(4-methylphenylsulphonyl)benzenediazonium zinc chloride (concentration 79%), see	–	4.1	3236
Dimethoxystrychnine, see	–	6.1	1570
Dimethyl acetal, see	–	3	2377
1,1-Dimethylacetone, see	–	3	2397
Dimethylacetylene, see	–	3	1144
DIMETHYLAMINE, ANHYDROUS	–	2.1	1032
DIMETHYLAMINE, AQUEOUS SOLUTION	–	3	1160
2-DIMETHYLAMINOACETONITRILE	–	3	2378
4-(Dimethylamino)benzenediazonium trichlorozincate(–1) (concentration 100%), see	–	4.1	3228
4-Dimethylamino-6-(2-dimethylaminoethoxy)toluene-2-diazonium zinc chloride (concentration 100%), see	–	4.1	3236
2-DIMETHYLAMINOETHANOL	–	8	2051
2-DIMETHYLAMINOETHYL ACRYLATE	–	6.1	3302
2-DIMETHYLAMINOETHYL METHACRYLATE	–	6.1	2522
N,N-DIMETHYLANILINE	–	6.1	2253
3,4-Dimethylaniline, see	–	6.1	1711
Dimethylarsinic acid, see	–	6.1	1572
Dimethylbenzenes, see	–	3	1307
Di-(2-methylbenzoyl) peroxide (concentration ≤87%, with water), see	–	5.2	3112

Substance, material or article	MP	Class	UN No.
Di-(3-methylbenzoyl) peroxide (concentration $\leq 20\%$ ), with benzoyl (3-methylbenzoyl) peroxide (concentration $\leq 18\%$ ), with dibenzoyl peroxide (concentration $\leq 4\%$ ) and diluent Type B, see	–	5.2	3115
Di-(4-methylbenzoyl) peroxide (concentration $\leq 52\%$ , as a paste with silicon oil), see	–	5.2	3106
Dimethylbenzylamine, see	–	8	2619
<i>N,N</i> -Dimethylbenzylamine, see	–	8	2619
2,3-DIMETHYLBUTANE	–	3	2457
1,3-DIMETHYLBUTYLAMINE	–	3	2379
DIMETHYLCARBAMOYL CHLORIDE	–	8	2262
Dimethyl carbinol, see	–	3	1219
DIMETHYL CARBONATE	–	3	1161
DIMETHYLCYCLOHEXANES	–	3	2263
<i>N,N</i> -DIMETHYLCYCLOHEXYLAMINE	–	8	2264
2,5-Dimethyl-2,5-di-(benzoylperoxy)hexane (concentration $\leq 82\%$ , with inert solid), see	–	5.2	3106
2,5-Dimethyl-2,5-di-(benzoylperoxy)hexane (concentration $\leq 82\%$ , with water), see	–	5.2	3104
2,5-Dimethyl-2,5-di-(benzoylperoxy)hexane (concentration $> 82-100\%$ ), see	–	5.2	3102
2,5-Dimethyl-2,5-di-( <i>tert</i> -butylperoxy)hexane (concentration $\leq 47\%$ , as a paste), see	–	5.2	3108
2,5-Dimethyl-2,5-di-( <i>tert</i> -butylperoxy)hexane (concentration $\leq 52\%$ , with diluent Type A), see	–	5.2	3109
2,5-Dimethyl-2,5-di-( <i>tert</i> -butylperoxy)hexane (concentration $> 52-90\%$ ), see	–	5.2	3105
2,5-Dimethyl-2,5-di-( <i>tert</i> -butylperoxy)hexane (concentration $\leq 77\%$ , with inert solid), see	–	5.2	3108
2,5-Dimethyl-2,5-di-( <i>tert</i> -butylperoxy)hexane (concentration $> 90-100\%$ ), see	–	5.2	3103
2,5-Dimethyl-2,5-di-( <i>tert</i> -butylperoxy)hexyne-3 (concentration $\leq 52\%$ , with inert solid), see	–	5.2	3106
2,5-Dimethyl-2,5-di-( <i>tert</i> -butylperoxy)hexyne-3 (concentration $> 52-86\%$ , with diluent Type A), see	–	5.2	3103
2,5-Dimethyl-2,5-di-( <i>tert</i> -butylperoxy)hexyne-3 (concentration $> 86-100\%$ ), see	–	5.2	3101
DIMETHYLDICHLOROSILANE	–	3	1162
DIMETHYLDIETHOXYLANE	–	3	2380
2,5-Dimethyl-2,5-di-(2-ethylhexanoylperoxy)hexane (concentration $\leq 100\%$ ), see	–	5.2	3113
2,5-Dimethyl-2,5-dihydroperoxyhexane (concentration $\leq 82\%$ , with water), see	–	5.2	3104
DIMETHYLDIOXANES	–	3	2707
DIMETHYL DISULPHIDE	–	3	2381
2,5-Dimethyl-2,5-di-(3,5,5-trimethylhexanoylperoxy)hexane (concentration $\leq 77\%$ , with diluent Type A), see	–	5.2	3105
<i>N,N</i> -Dimethyldodecylamine, see Note 1	P	–	–
Dimethyleneimine, stabilized, see	–	6.1	1185

Index

Substance, material or article	MP	Class	UN No.
Dimethylethanolamine, <i>see</i>	–	8	2051
DIMETHYL ETHER	–	2.1	1033
<i>N,N</i> -DIMETHYLFORMAMIDE	–	3	2265
<i>N,N</i> -Dimethylglycinonitrile, <i>see</i>	–	3	2378
Dimethylglyoxal, <i>see</i>	–	3	2346
2,6-Dimethyl-4-heptanone, <i>see</i>	–	3	1157
1,1-Dimethylhydrazine, <i>see</i>	P	6.1	1163
1,2-Dimethylhydrazine, <i>see</i>	P	6.1	2382
DIMETHYLHYDRAZINE, SYMMETRICAL	P	6.1	2382
DIMETHYLHYDRAZINE, UNSYMMETRICAL	P	6.1	1163
1,1-Dimethyl-3-hydroxybutyl peroxyneohexanoate (concentration ≤52%, with diluent Type A), <i>see</i>	–	5.2	3117
Dimethyl ketone, <i>see</i>	–	3	1090
Dimethyl ketone solutions, <i>see</i>	–	3	1090
<i>N,N</i> -Dimethyl-4-nitrosoaniline, <i>see</i>	–	4.2	1369
<i>para</i> -Dimethylnitrosoaniline, <i>see</i>	–	4.2	1369
Dimethylphenols, liquid, <i>see</i>	–	6.1	3430
Dimethylphenols, solid, <i>see</i>	–	6.1	2261
Dimethyl phosphorochlorodithionate, <i>see</i>	–	6.1	2267
2,2-DIMETHYLPROPANE	–	2.1	2044
DIMETHYL-N-PROPYLAMINE	–	3	2266
Dimethyl- <i>n</i> -propylamine, <i>see</i>	–	3	2266
Dimethyl <i>normal</i> -propyl carbinol, <i>see</i>	–	3	2560
DIMETHYL SULPHATE	–	6.1	1595
DIMETHYL SULPHIDE	–	3	1164
DIMETHYL THIOPHOSPHORYL CHLORIDE	–	6.1	2267
Dimethylzinc, <i>see</i>	–	4.2	3394
Dimetilan, <i>see</i> CARBAMATE PESTICIDE	–	–	–
Dimexano, <i>see</i> PESTICIDE, N.O.S.	–	–	–
Dimyristyl peroxydicarbonate (concentration ≤42%, as a stable dispersion in water), <i>see</i>	–	5.2	3119
Dimyristyl peroxydicarbonate (concentration ≤100%), <i>see</i>	–	5.2	3116
Di-(2-neodecanoylperoxyisopropyl)benzene (concentration ≤52%, with diluent Type A), <i>see</i>	–	5.2	3115
DINGU	–	1.1D	0489
DINITROANILINES	–	6.1	1596
DINITROBENZENES, LIQUID	–	6.1	1597
DINITROBENZENES, SOLID	–	6.1	3443
Dinitrochlorobenzenes, liquid, <i>see</i>	P	6.1	1577
Dinitrochlorobenzenes, solid, <i>see</i>	P	6.1	3441
DINITRO- <i>o</i> -CRESOL	P	6.1	1598
Dinitrogen oxide, <i>see</i>	–	2.2	1070
Dinitrogen oxide, refrigerated liquid, <i>see</i>	–	2.2	2201
DINITROGEN TETROXIDE	–	2.3	1067

Substance, material or article	MP	Class	UN No.
Dinitrogen tetroxide and nitric oxide mixtures, see NITRIC OXIDE AND DINITROGEN TETROXIDE MIXTURE	–	–	–
Dinitrogen trioxide, see	–	2.3	2421
DINITROGLYCOLURIL	–	1.1D	0489
Dinitrophenates (class 1), see	P	1.3C	0077
Dinitrophenates, wetted, see	P	4.1	1321
DINITROPHENOLATES alkali metals, dry or wetted with less than 15% water, by mass	P	1.3C	0077
DINITROPHENOLATES, WETTED with not less than 15% water, by mass	P	4.1	1321
DINITROPHENOL dry or wetted with less than 15% water, by mass	P	1.1D	0076
DINITROPHENOL SOLUTION	P	6.1	1599
DINITROPHENOL, WETTED with not less than 15% water, by mass	P	4.1	1320
DINITRORESORCINOL dry or wetted with less than 15% water, by mass	–	1.1D	0078
DINITRORESORCINOL, WETTED with not less than 15% water, by mass	–	4.1	1322
DINITROSOBENZENE	–	1.3C	0406
<i>N,N'</i> -Dinitroso- <i>N,N'</i> -dimethylterephthalamide, as a paste (concentration 72%), see	–	4.1	3224
<i>N,N'</i> -Dinitrosopentamethylenetetramine (concentration 82%), see	–	4.1	3224
Dinitrotoluene mixed with sodium chlorate, see	–	1.1D	0083
DINITROTOLUENES, LIQUID	–	6.1	2038
DINITROTOLUENES, MOLTEN	–	6.1	1600
DINITROTOLUENES, SOLID	–	6.1	3454
Dinobuton, see SUBSTITUTED NITROPHENOL PESTICIDE	P	–	–
Di- <i>n</i> -nonanoyl peroxide (concentration ≤100%), see	–	5.2	3116
Dinoseb, see SUBSTITUTED NITROPHENOL PESTICIDE	P	–	–
Dinoseb acetate, see SUBSTITUTED NITROPHENOL PESTICIDE	P	–	–
Dinoterb, see SUBSTITUTED NITROPHENOL PESTICIDE	–	–	–
Dinoterb acetate, see SUBSTITUTED NITROPHENOL PESTICIDE	–	–	–
Di- <i>n</i> -octanoyl peroxide (concentration ≤100%), see	–	5.2	3114
Dioxacarb, see CARBAMATE PESTICIDE	P	–	–
DIOXANE	–	3	1165
Dioxathion, see ORGANOPHOSPHORUS PESTICIDE	P	–	–
DIOXOLANE	–	3	1166
DIPENTENE	P	3	2052
Di- <i>normal</i> -pentylamine, see	–	3	2841
Diphacinone, see PESTICIDE, N.O.S.	P	–	–
Di-(2-phenoxyethyl) peroxydicarbonate (concentration ≤85%, with water), see	–	5.2	3106
Di-(2-phenoxyethyl) peroxydicarbonate (concentration >85–100%), see	–	5.2	3102
Diphenyl, see	P	9	3077
DIPHENYLAMINE CHLOROARSINE	P	6.1	1698
Diphenylbromomethane, see	–	8	1770

Index

Substance, material or article	MP	Class	UN No.
DIPHENYLCHLOROARSINE, LIQUID	P	6.1	1699
DIPHENYLCHLOROARSINE, SOLID	P	6.1	3450
DIPHENYLDICHLOROSILANE	–	8	1769
DIPHENYLMETHYL BROMIDE	–	8	1770
Diphenyloxide-4,4'-disulphonylhydrazide (concentration 100%), see	–	4.1	3226
DIPICRYLAMINE	–	1.1D	0079
DIPICRYL SULPHIDE dry or wetted with less than 10% water, by mass	–	1.1D	0401
DIPICRYL SULPHIDE, WETTED with not less than 10% water, by mass	–	4.1	2852
Di-2-propenylamine, see	–	3	2359
Dipropionyl peroxide (concentration $\leq$ 27%, with diluent Type B), see	–	5.2	3117
DIPROPYLAMINE	–	3	2383
Di-normal-propylamine, see	–	3	2383
4-Dipropylaminobenzenediazonium zinc chloride (concentration 100%), see	–	4.1	3226
Dipropylenetriamine, see	–	8	2269
DI- <i>n</i> -PROPYL ETHER	–	3	2384
DIPROPYL KETONE	–	3	2710
Di- <i>n</i> -propyl peroxydicarbonate (concentration $\leq$ 77%, with diluent Type B), see	–	5.2	3113
Di- <i>n</i> -propyl peroxydicarbonate (concentration $\leq$ 100%), see	–	5.2	3113
Diquat, see BIPYRIDILIUM PESTICIDE	–	–	–
DISINFECTANT, LIQUID, CORROSIVE, N.O.S.	–	8	1903
DISINFECTANT, LIQUID, TOXIC, N.O.S.	–	6.1	3142
DISINFECTANT, SOLID, TOXIC, N.O.S.	–	6.1	1601
DISODIUM TRIOXOSILICATE	–	8	3253
Disodium trioxosilicate pentahydrate, see	–	8	3253
Disuccinic acid peroxide (concentration $\leq$ 72%, with water), see	–	5.2	3116
Disuccinic acid peroxide (concentration >72–100%), see	–	5.2	3102
Disulfoton, see ORGANOPHOSPHORUS PESTICIDE	P	–	–
Disulphuric acid, see	–	8	1831
Disulphuryl chloride, see	–	8	1817
Di-(3,5,5-trimethylhexanoyl) peroxide (concentration $\leq$ 38%, with diluent Type A), see	–	5.2	3119
Di-(3,5,5-trimethylhexanoyl) peroxide (concentration >52–82%, with diluent Type A), see	–	5.2	3115
Di-(3,5,5-trimethylhexanoyl) peroxide (concentration $\leq$ 52%, as a stable dispersion in water), see	–	5.2	3119
Di-(3,5,5-trimethylhexanoyl) peroxide (concentration >38–52%, with diluent Type A), see	–	5.2	3119
DIVINYL ETHER, STABILIZED	–	3	1167
Divinyl oxide, stabilized, see	–	3	1167
Divinyl, stabilized, see	–	2.1	1010
DNOC, see	P	6.1	1598
DNOC (pesticide), see SUBSTITUTED NITROPHENOL PESTICIDE	P	–	–
Dodecahydrodiphenylamine, see	–	8	2565

Substance, material or article	MP	Class	UN No.
Dodecene, <i>see</i>	–	3	2850
1-Dodecylamine, <i>see Note 1</i>	P	–	–
Dodecyl diphenyl oxide disulphonate, <i>see</i>	P	9	3077
Dodecyl hydroxypropyl sulphide, <i>see Note 1</i>	P	–	–
Dodecylphenol, <i>see</i>	P	8	3145
DODECYLTRICHLOROSILANE	–	8	1771
Drazoxolon, <i>see</i> PESTICIDE, N.O.S.	P	–	–
DRY ICE	–	9	1845
DYE INTERMEDIATE, LIQUID, CORROSIVE, N.O.S.	–	8	2801
DYE INTERMEDIATE, LIQUID, TOXIC, N.O.S.	–	6.1	1602
DYE INTERMEDIATE, SOLID, CORROSIVE, N.O.S.	–	8	3147
DYE INTERMEDIATE, SOLID, TOXIC, N.O.S.	–	6.1	3143
DYE, LIQUID, CORROSIVE, N.O.S.	–	8	2801
DYE, LIQUID, TOXIC, N.O.S.	–	6.1	1602
DYE, SOLID, CORROSIVE, N.O.S.	–	8	3147
DYE, SOLID, TOXIC, N.O.S.	–	6.1	3143
Dynamite, <i>see</i>	–	1.1D	0081
Edifenphos, <i>see</i> ORGANOPHOSPHORUS PESTICIDE	P	–	–
Electric storage batteries, <i>see</i> BATTERIES	–	–	–
Electrolyte (acid) for batteries, <i>see</i>	–	8	2796
Electrolyte (alkaline) for batteries, <i>see</i>	–	8	2797
ELEVATED TEMPERATURE LIQUID, FLAMMABLE, N.O.S. with flashpoint above 60°C, at or above its flashpoint	–	3	3256
ELEVATED TEMPERATURE LIQUID, N.O.S. at or above 100°C and below its flashpoint (including molten metals, molten salts, etc.)	–	9	3257
ELEVATED TEMPERATURE SOLID, N.O.S. at or above 240°C	–	9	3258
Enamel, <i>see</i> PAINT	–	–	–
Endosulfan, <i>see</i> ORGANOCHLORINE PESTICIDE	P	–	–
Endothal-sodium, <i>see</i> PESTICIDE, N.O.S.	–	–	–
Endothion, <i>see</i> ORGANOPHOSPHORUS PESTICIDE	–	–	–
Endrin, <i>see</i> ORGANOCHLORINE PESTICIDE	P	–	–
ENGINE, FUEL CELL, FLAMMABLE GAS POWERED	–	9	3166
ENGINE, FUEL CELL, FLAMMABLE LIQUID POWERED	–	9	3166
ENGINE, INTERNAL COMBUSTION	–	9	3166
Engines, rocket, <i>see</i> ROCKET MOTORS WITH HYPERGOLIC LIQUIDS	–	–	–
ENVIRONMENTALLY HAZARDOUS SUBSTANCE, LIQUID, N.O.S.	–	9	3082
ENVIRONMENTALLY HAZARDOUS SUBSTANCE, SOLID, N.O.S.	–	9	3077
EPIBROMOHYDRIN	P	6.1	2558
EPICHLOROHYDRIN	P	6.1	2023
EPN, <i>see</i> ORGANOPHOSPHORUS PESTICIDE	P	–	–
1,2-Epoxybutane, stabilized, <i>see</i>	–	3	3022
1,2-Epoxyethane, <i>see</i>	–	2.3	1040

Index

Substance, material or article	MP	Class	UN No.
1,2-Epoxyethane with nitrogen up to a total pressure of 1 MPa (10 bar) at 50°C, see	–	2.3	1040
1,2-EPOXY-3-ETHOXYPROPANE	–	3	2752
2,3-Epoxy-1-propanal, see	–	3	2622
1,2-Epoxypropane, see	–	3	1280
2,3-Epoxypropionaldehyde, see	–	3	2622
2,3-Epoxypropyl ethyl ether, see	–	3	2752
Esfenvalerate, see <b>Note 1</b>	<b>P</b>	–	–
ESTERS, N.O.S.	–	3	3272
Ethanal, see	–	3	1089
ETHANE	–	2.1	1035
ETHANE, REFRIGERATED LIQUID	–	2.1	1961
Ethanethiol, see	<b>P</b>	3	2363
Ethanoic anhydride, see	–	8	1715
ETHANOL	–	3	1170
ETHANOLAMINE	–	8	2491
ETHANOLAMINE SOLUTION	–	8	2491
ETHANOL AND GASOLINE MIXTURE, with more than 10% ethanol	–	3	3475
ETHANOL AND MOTOR SPIRIT MIXTURE, with more than 10% ethanol	–	3	3475
ETHANOL AND PETROL MIXTURE, with more than 10% ethanol	–	3	3475
ETHANOL SOLUTION	–	3	1170
Ethanoyl chloride, see	–	3	1717
Ether, see	–	3	1155
ETHERS, N.O.S.	–	3	3271
Ethion, see ORGANOPHOSPHORUS PESTICIDE	<b>P</b>	–	–
Ethoate-methyl, see ORGANOPHOSPHORUS PESTICIDE	–	–	–
Ethoprophos, see ORGANOPHOSPHORUS PESTICIDE	<b>P</b>	–	–
2-( <i>N,N</i> -Ethoxycarbonylphenylamino)-3-methoxy-4-( <i>N</i> -methyl- <i>N</i> -cyclohexylamino)benzenediazonium zinc chloride (concentration 62%), see	–	4.1	3236
2-( <i>N,N</i> -Ethoxycarbonylphenylamino)-3-methoxy-4-( <i>N</i> -methyl- <i>N</i> -cyclohexylamino)benzenediazonium zinc chloride (concentration 63–92%), see	–	4.1	3236
2-Ethoxyethanol, see	–	3	1171
2-Ethoxyethyl acetate, see	–	3	1172
1-Ethoxypropane, see	–	3	2615
3-Ethoxy-1-propene, see	–	3	2335
ETHYL ACETATE	–	3	1173
Ethylacetic acid, see	–	8	2820
Ethylacetone, see	–	3	1249
ETHYLACETYLENE, STABILIZED	–	2.1	2452
ETHYL ACRYLATE, STABILIZED	–	3	1917
Ethylal, see	–	3	2373
ETHYL ALCOHOL	–	3	1170
ETHYL ALCOHOL SOLUTION	–	3	1170

Substance, material or article	MP	Class	UN No.
Ethyl aldehyde, see	–	3	1089
Ethyl allyl ether, see	–	3	2335
ETHYLAMINE	–	2.1	1036
ETHYLAMINE, AQUEOUS SOLUTION with not less than 50% but not more than 70% ethylamine	–	3	2270
ETHYL AMYL KETONES	–	3	2271
Ethyl <i>normal</i> -amyl ketone, see	–	3	2271
2-ETHYLANILINE	–	6.1	2273
<i>N</i> -ETHYLANILINE	–	6.1	2272
<i>ortho</i> -Ethylaniline, see	–	6.1	2273
ETHYLBENZENE	–	3	1175
Ethylbenzol, see	–	3	1175
<i>N</i> -ETHYL- <i>N</i> -BENZYLANILINE	–	6.1	2274
<i>N</i> -ETHYLBENZYL TOLUIDINES, LIQUID	–	6.1	2753
<i>N</i> -ETHYLBENZYL TOLUIDINES, SOLID	–	6.1	3460
ETHYL BORATE	–	3	1176
ETHYL BROMIDE	–	6.1	1891
ETHYL BROMOACETATE	–	6.1	1603
Ethyl butanoate, see	–	3	1180
2-ETHYLBUTANOL	–	3	2275
2-ETHYLBUTYL ACETATE	–	3	1177
2-Ethylbutyl alcohol, see	–	3	2275
ETHYL BUTYL ETHER	–	3	1179
2-ETHYLBUTYRALDEHYDE	–	3	1178
ETHYL BUTYRATE	–	3	1180
Ethyl carbonate, see	–	3	2366
ETHYL CHLORIDE	–	2.1	1037
ETHYL CHLOROACETATE	–	6.1	1181
Ethyl chlorocarbonate, see	–	6.1	1182
Ethyl chloroethanoate, see	–	6.1	1181
ETHYL CHLOROFORMATE	–	6.1	1182
ETHYL 2-CHLOROPROPIONATE	–	3	2935
ETHYL CHLOROTHIOFORMATE	P	8	2826
ETHYL CROTONATE	–	3	1862
Ethyl cyanide, see	–	3	2404
Ethyl 3,3-di-( <i>tert</i> -amylperoxy)butyrate (concentration ≤67%, with diluent Type A), see	–	5.2	3105
Ethyl 3,3-di-( <i>tert</i> -butylperoxy)butyrate (concentration ≤52%, with inert solid), see	–	5.2	3106
Ethyl 3,3-di-( <i>tert</i> -butylperoxy)butyrate (concentration ≤77%, with diluent Type A), see	–	5.2	3105
Ethyl 3,3-di-( <i>tert</i> -butylperoxy)butyrate (concentration >77–100%), see	–	5.2	3103
ETHYLDICHLOROARSINE	P	6.1	1892
ETHYLDICHLOROSILANE	–	4.3	1183



Index

Substance, material or article	MP	Class	UN No.
ETHYLENE	–	2.1	1962
ETHYLENE, ACETYLENE AND PROPYLENE MIXTURE, REFRIGERATED LIQUID containing at least 71.5% ethylene, with not more than 22.5% acetylene and not more than 6% propylene	–	2.1	3138
Ethylene chloride, <i>see</i>	–	3	1184
ETHYLENE CHLOROHYDRIN	–	6.1	1135
ETHYLENEDIAMINE	–	8	1604
ETHYLENE DIBROMIDE	–	6.1	1605
Ethylene dibromide and methyl bromide mixture, liquid, <i>see</i>	P	6.1	1647
ETHYLENE DICHLORIDE	–	3	1184
Ethylene fluoride, <i>see</i>	–	2.1	1030
ETHYLENE GLYCOL DIETHYL ETHER	–	3	1153
Ethylene glycol dimethyl ether, <i>see</i>	–	3	2252
ETHYLENE GLYCOL MONOETHYL ETHER	–	3	1171
ETHYLENE GLYCOL MONOETHYL ETHER ACETATE	–	3	1172
ETHYLENE GLYCOL MONOMETHYL ETHER	–	3	1188
ETHYLENE GLYCOL MONOMETHYL ETHER ACETATE	–	3	1189
ETHYLENEIMINE, STABILIZED	–	6.1	1185
ETHYLENE OXIDE	–	2.3	1040
ETHYLENE OXIDE AND CARBON DIOXIDE MIXTURE with more than 87% ethylene oxide	–	2.3	3300
ETHYLENE OXIDE AND CARBON DIOXIDE MIXTURE with more than 9% but not more than 87% ethylene oxide	–	2.1	1041
ETHYLENE OXIDE AND CARBON DIOXIDE MIXTURE with not more than 9% ethylene oxide	–	2.2	1952
ETHYLENE OXIDE AND CHLOROTETRAFLUOROETHANE MIXTURE with not more than 8.8% ethylene oxide	–	2.2	3297
ETHYLENE OXIDE AND DICHLORODIFLUOROMETHANE MIXTURE with not more than 12.5% ethylene oxide	–	2.2	3070
ETHYLENE OXIDE AND PENTAFLUOROETHANE MIXTURE with not more than 7.9% ethylene oxide	–	2.2	3298
ETHYLENE OXIDE AND PROPYLENE OXIDE MIXTURE with not more than 30% ethylene oxide	–	3	2983
ETHYLENE OXIDE AND TETRAFLUOROETHANE MIXTURE with not more than 5.6% ethylene oxide	–	2.2	3299
ETHYLENE OXIDE WITH NITROGEN up to a total pressure of 1 MPa (10 bar) at 50°C	–	2.3	1040
ETHYLENE, REFRIGERATED LIQUID	–	2.1	1038
Ethyl ethanoate, <i>see</i>	–	3	1173
ETHYL ETHER	–	3	1155
Ethyl fluid, <i>see</i>	P	6.1	1649
ETHYL FLUORIDE	–	2.1	2453
ETHYL FORMATE	–	3	1190
Ethyl glycol, <i>see</i>	–	3	1171
Ethyl glycol acetate, <i>see</i>	–	3	1172
2-Ethylhexaldehyde, <i>see</i>	–	3	1191
3-Ethylhexaldehyde, <i>see</i>	–	3	1191

Substance, material or article	MP	Class	UN No.
2-Ethylhexanal, see	–	3	1191
3-Ethylhexanal, see	–	3	1191
1-(2-Ethylhexanoylperoxy)-1,3-dimethylbutyl peroxy-pivalate (concentration ≤52%, with diluents Type A and B), see	–	5.2	3115
2-ETHYLHEXYLAMINE	–	3	2276
2-ETHYLHEXYL CHLOROFORMATE	–	6.1	2748
2-Ethylhexyl nitrate, see <b>Note 1</b>	P	–	–
Ethyl hydrosulphide, see	P	3	2363
Ethylidene chloride, see	–	3	2362
Ethylidene dichloride, see	–	3	2362
Ethylidene diethyl ether, see	–	3	1088
Ethylidene difluoride, see	–	2.1	1030
Ethylidene dimethyl ether, see	–	3	2377
Ethylidene fluoride, see	–	2.1	1030
ETHYL ISOBUTYRATE	–	3	2385
ETHYL ISOCYANATE	–	6.1	2481
Ethyl isopropyl ether, see	–	3	2615
ETHYL LACTATE	–	3	1192
ETHYL MERCAPTAN	P	3	2363
ETHYL METHACRYLATE, STABILIZED	–	3	2277
Ethyl methanoate, see	–	3	1190
1-Ethyl-2-methylbenzene, see <b>Note 1</b>	P	–	–
ETHYL METHYL ETHER	–	2.1	1039
ETHYL METHYL KETONE	–	3	1193
Ethyl 2-methylpropanoate, see	–	3	2385
ETHYL NITRITE (transport prohibited)	–	–	–
ETHYL NITRITE SOLUTION	–	3	1194
ETHYL ORTHOFORMATE	–	3	2524
ETHYL OXALATE	–	6.1	2525
Ethylphenylamine, see	–	6.1	2272
N-Ethyl-N-phenylbenzylamine, see	–	6.1	2274
ETHYLPHENYLDICHLOROSILANE	–	8	2435
5-Ethyl-2-picoline, see	–	6.1	2300
1-ETHYLPIPERIDINE	–	3	2386
N-Ethylpiperidine, see	–	3	2386
Ethyl propenoate, stabilized, see	–	3	1917
ETHYL PROPIONATE	–	3	1195
ETHYL PROPYL ETHERS	–	3	2615
Ethyl <i>secondary</i> -amyl ketone, see	–	3	2271
Ethyl silicate, see	–	3	1292
Ethyl sulphate, see	–	6.1	1594
Ethyl sulphide, see	–	3	2375
Ethyl tetraphosphate, see	P	6.1	1611

Index

Substance, material or article	MP	Class	UN No.
Ethyl thioalcohol, <i>see</i>	P	3	2363
Ethylthioethane, <i>see</i>	–	3	2375
N-ETHYLTOLUIDINES	–	6.1	2754
ETHYLTRICHLOROSILANE	–	3	1196
Ethyl vinyl ether, <i>see</i>	–	3	1302
Explosive articles, N.O.S., <i>see</i> ARTICLES, EXPLOSIVE, N.O.S.	–	–	–
EXPLOSIVE, BLASTING, TYPE A	–	1.1D	0081
EXPLOSIVE, BLASTING, TYPE B	–	1.1D	0082
EXPLOSIVE, BLASTING, TYPE B	–	1.5D	0331
EXPLOSIVE, BLASTING, TYPE C	–	1.1D	0083
EXPLOSIVE, BLASTING, TYPE D	–	1.1D	0084
EXPLOSIVE, BLASTING, TYPE E	–	1.1D	0241
EXPLOSIVE, BLASTING, TYPE E	–	1.5D	0332
Explosive, seismic, <i>see</i> EXPLOSIVE, BLASTING, TYPES A to D	–	–	–
Explosives, emulsion, <i>see</i> EXPLOSIVE, BLASTING, TYPE E	–	–	–
Explosive, slurry, <i>see</i> EXPLOSIVE, BLASTING, TYPE E	–	–	–
Explosive substances, N.O.S., <i>see</i> SUBSTANCES, EXPLOSIVE, N.O.S.	–	–	–
Explosive train components, N.O.S., <i>see</i> COMPONENTS, EXPLOSIVE TRAIN, N.O.S.	–	–	–
Explosive, waterngel, <i>see</i> EXPLOSIVE, BLASTING, TYPE E	–	–	–
EXTRACTS, AROMATIC, LIQUID	–	3	1169
EXTRACTS, FLAVOURING, LIQUID	–	3	1197
FABRICS, ANIMAL, N.O.S. with oil	–	4.2	1373
FABRICS IMPREGNATED WITH WEAKLY NITRATED NITROCELLULOSE, N.O.S.	–	4.1	1353
FABRICS, SYNTHETIC, N.O.S. with oil	–	4.2	1373
FABRICS, VEGETABLE, N.O.S. with oil	–	4.2	1373
Fenaminosulf, <i>see</i> PESTICIDE, N.O.S.	–	–	–
Fenamiphos, <i>see</i> ORGANOPHOSPHORUS PESTICIDE	P	–	–
Fenbutatin oxide, <i>see</i> <b>Note 1</b>	P	–	–
Fenitrothion, <i>see</i> ORGANOPHOSPHORUS PESTICIDE	P	–	–
Fenoxapro-ethyl, <i>see</i> <b>Note 1</b>	P	–	–
Fenoxaprop-P-ethyl, <i>see</i> <b>Note 1</b>	P	–	–
Fenpropathrin, <i>see</i> PESTICIDE, N.O.S.	P	–	–
Fensulfothion, <i>see</i> ORGANOPHOSPHORUS PESTICIDE	P	–	–
Fenthion, <i>see</i> ORGANOPHOSPHORUS PESTICIDE	P	–	–
Fentin acetate, <i>see</i> ORGANOTIN PESTICIDE	P	–	–
Fentin hydroxide, <i>see</i> ORGANOTIN PESTICIDE	P	–	–
Fermentation amyl alcohol, <i>see</i>	–	3	1201
FERRIC ARSENATE	P	6.1	1606
FERRIC ARSENITE	P	6.1	1607
FERRIC CHLORIDE, ANHYDROUS	–	8	1773
FERRIC CHLORIDE SOLUTION	–	8	2582

Substance, material or article	MP	Class	UN No.
FERRIC NITRATE	–	5.1	1466
Ferric perchloride, anhydrous, <i>see</i>	–	8	1773
Ferric perchloride solution, <i>see</i>	–	8	2582
FERROCERIUM	–	4.1	1323
FERROSILICON with 30% or more but less than 90% silicon	–	4.3	1408
FERROUS ARSENATE	P	6.1	1608
FERROUS METAL BORINGS in a form liable to self-heating	–	4.2	2793
FERROUS METAL CUTTINGS in a form liable to self-heating	–	4.2	2793
FERROUS METAL SHAVINGS in a form liable to self-heating	–	4.2	2793
FERROUS METAL TURNINGS in a form liable to self-heating	–	4.2	2793
FERTILIZER AMMONIATING SOLUTION with free ammonia	–	2.2	1043
Fertilizers containing ammonium nitrate, <i>see</i> AMMONIUM NITRATE BASED FERTILIZERS	–	–	–
FIBRES, ANIMAL burnt	–	4.2	1372
FIBRES, ANIMAL damp	–	4.2	1372
FIBRES, ANIMAL wet	–	4.2	1372
FIBRES, ANIMAL, N.O.S. with oil,	–	4.2	1373
FIBRES, SYNTHETIC, N.O.S. with oil	–	4.2	1373
FIBRES VEGETABLE burnt	–	4.2	1372
FIBRES VEGETABLE damp	–	4.2	1372
FIBRES, VEGETABLE, DRY	–	4.1	3360
FIBRES VEGETABLE wet	–	4.2	1372
FIBRES, VEGETABLE, N.O.S. with oil	–	4.2	1373
FIBRES IMPREGNATED WITH WEAKLY NITRATED NITROCELLULOSE, N.O.S.	–	4.1	1353
Filler, liquid, <i>see</i> PAINT	–	–	–
Films, nitrocellulose-base, from which gelatin has been removed; film scrap, <i>see</i>	–	4.2	2002
FILMS, NITROCELLULOSE BASE gelatin coated, except scrap	–	4.1	1324
FIRE EXTINGUISHER CHARGES corrosive liquid	–	8	1774
Fire extinguisher charges, expelling, explosive, <i>see</i> CARTRIDGES, POWER DEVICE	–	–	–
FIRE EXTINGUISHERS with compressed or liquefied gas	–	2.2	1044
FIRELIGHTERS, SOLID with flammable liquid	–	4.1	2623
FIREWORKS	–	1.1G	0333
FIREWORKS	–	1.2G	0334
FIREWORKS	–	1.3G	0335
FIREWORKS	–	1.4G	0336
FIREWORKS	–	1.4S	0337
FIRST AID KIT	–	9	3316
FISHMEAL, STABILIZED anti-oxidant treated. Moisture content greater than 5% but not exceeding 12%, by mass. Fat content not more than 15%	–	9	2216

Index

Substance, material or article	MP	Class	UN No.
FISHMEAL, UNSTABILIZED. High hazard. Unrestricted moisture content. Unrestricted fat content in excess of 12%, by mass. Unrestricted fat content in excess of 15%, by mass, in the case of anti-oxidant treated fishmeal	–	4.2	1374
FISHMEAL, UNSTABILIZED not anti-oxidant treated. Moisture content: more than 5% but not more than 12%, by mass. Fat content: not more than 12%, by mass	–	4.2	1374
FISHSCRAP, STABILIZED anti-oxidant treated. Moisture content greater than 5% but not exceeding 12%, by mass. Fat content not more than 15%	–	9	2216
FISHSCRAP, UNSTABILIZED. High hazard. Unrestricted moisture content. Unrestricted fat content in excess of 12%, by mass. Unrestricted fat content in excess of 15%, by mass, in the case of anti-oxidant treated fishscrap	–	4.2	1374
FISHSCRAP, UNSTABILIZED not anti-oxidant treated. Moisture content: more than 5% but not more than 12%, by mass. Fat content: not more than 12%, by mass	–	4.2	1374
Flammable gas in lighters, <i>see</i>	–	2.1	1057
FLAMMABLE LIQUID, CORROSIVE, N.O.S.	–	3	2924
FLAMMABLE LIQUID, N.O.S.	–	3	1993
FLAMMABLE LIQUID, TOXIC, CORROSIVE, N.O.S.	–	3	3286
FLAMMABLE LIQUID, TOXIC, N.O.S.	–	3	1992
FLAMMABLE SOLID, CORROSIVE, INORGANIC, N.O.S.	–	4.1	3180
FLAMMABLE SOLID, CORROSIVE, ORGANIC, N.O.S.	–	4.1	2925
FLAMMABLE SOLID, INORGANIC, N.O.S.	–	4.1	3178
FLAMMABLE SOLID, ORGANIC, MOLTEN, N.O.S.	–	4.1	3176
FLAMMABLE SOLID, ORGANIC, N.O.S.	–	4.1	1325
FLAMMABLE SOLID, OXIDIZING, N.O.S.	–	4.1	3097
FLAMMABLE SOLID, TOXIC, INORGANIC, N.O.S.	–	4.1	3179
FLAMMABLE SOLID, TOXIC, ORGANIC, N.O.S.	–	4.1	2926
FLARES, AERIAL	–	1.1G	0420
FLARES, AERIAL	–	1.2G	0421
FLARES, AERIAL	–	1.3G	0093
FLARES, AERIAL	–	1.4G	0403
FLARES, AERIAL	–	1.4S	0404
Flares, distress, small, <i>see</i> SIGNAL DEVICES, HAND	–	–	–
Flares, highway or railway, <i>see</i> SIGNAL DEVICES, HAND	–	–	–
FLARES, SURFACE	–	1.1G	0418
FLARES, SURFACE	–	1.2G	0419
FLARES, SURFACE	–	1.3G	0092
Flares, water-activated, <i>see</i> CONTRIVANCES, WATER-ACTIVATED	–	–	–
FLASH POWDER	–	1.1G	0094
FLASH POWDER	–	1.3G	0305
Flax, dry, <i>see</i>	–	4.1	3360
Flowers of sulphur, <i>see</i>	–	4.1	1350
Flue dust, arsenical, <i>see</i>	–	6.1	1562

Substance, material or article	MP	Class	UN No.
Fluoric acid, see	–	8	1790
Fluorine compounds (pesticides), see PESTICIDE, N.O.S.	–	–	–
FLUORINE, COMPRESSED	–	2.3	1045
Fluorine monoxide, compressed, see	–	2.3	2190
Fluoroacetamide, see PESTICIDE, N.O.S.	–	–	–
FLUOROACETIC ACID	–	6.1	2642
FLUOROANILINES	–	6.1	2941
FLUOROBENZENE	–	3	2387
FLUOROBORIC ACID	–	8	1775
Fluoroethane, see	–	2.1	2453
Fluoroethanoic acid, see	–	6.1	2642
Fluoroform, see	–	2.2	1984
Fluoroformyl fluoride, compressed, see	–	2.3	2417
Fluoromethane, see	–	2.1	2454
FLUOROPHOSPHORIC ACID, ANHYDROUS	–	8	1776
FLUOROSILICATES, N.O.S.	–	6.1	2856
FLUOROSILICIC ACID	–	8	1778
FLUOROSULPHONIC ACID	–	8	1777
FLUOROTOLUENES	–	3	2388
Fonofos, see ORGANOPHOSPHORUS PESTICIDE	P	–	–
Formal, see	–	3	1234
Formaldehyde dimethylacetal, see	–	3	1234
FORMALDEHYDE SOLUTION, FLAMMABLE	–	3	1198
FORMALDEHYDE SOLUTION with not less than 25% formaldehyde	–	8	2209
Formalin solution, flammable, see	–	3	1198
Formalin solution with not less than 25% formaldehyde, see	–	8	2209
Formamidine sulphinic acid, see	–	4.2	3341
Formetanate, see CARBAMATE PESTICIDE	P	–	–
Formic acid ethyl ester, see	–	3	1190
FORMIC ACID with more than 85% acid, by mass	–	8	1779
FORMIC ACID with not less than 5% but less than 10% acid, by mass	–	8	3412
FORMIC ACID with not less than 10% but not more than 85% acid, by mass	–	8	3412
Formic aldehyde solution, flammable, see	–	3	1198
Formothion, see ORGANOPHOSPHORUS PESTICIDE	–	–	–
2-Formyl-3,4-dihydro-2H-pyran, stabilized, see	–	3	2607
N-Formyl-2-(nitromethylene)-1,3-perhydrothiazine (concentration 100%), see	–	4.1	3236
FRACTURING DEVICES, EXPLOSIVE for oil wells, without detonator	–	1.1D	0099
FUEL, AVIATION, TURBINE ENGINE	–	3	1863
FUEL CELL CARTRIDGES	–	3	3473
FUEL CELL CARTRIDGES, containing corrosive substances	–	8	3477
FUEL CELL CARTRIDGES, containing hydrogen in metal hydride	–	2.1	3479

Index

Substance, material or article	MP	Class	UN No.
FUEL CELL CARTRIDGES, containing liquefied flammable gas	–	2.1	3478
FUEL CELL CARTRIDGES, containing water-reactive substances	–	4.3	3476
FUEL CELL CARTRIDGES CONTAINED IN EQUIPMENT	–	3	3473
FUEL CELL CARTRIDGES CONTAINED IN EQUIPMENT, containing corrosive substances	–	8	3477
FUEL CELL CARTRIDGES CONTAINED IN EQUIPMENT, containing hydrogen in metal hydride	–	2.1	3479
FUEL CELL CARTRIDGES CONTAINED IN EQUIPMENT, containing liquefied flammable gas	–	2.1	3478
FUEL CELL CARTRIDGES CONTAINED IN EQUIPMENT, containing water-reactive substances	–	4.3	3476
FUEL CELL CARTRIDGES PACKED WITH EQUIPMENT, containing corrosive substances	–	8	3477
FUEL CELL CARTRIDGES PACKED WITH EQUIPMENT, containing hydrogen in metal hydride	–	2.1	3479
FUEL CELL CARTRIDGES PACKED WITH EQUIPMENT, containing liquefied flammable gas	–	2.1	3478
FUEL CELL CARTRIDGES PACKED WITH EQUIPMENT, containing water-reactive substances	–	4.3	3476
FUEL CELL CARTRIDGES PLACED WITH EQUIPMENT	–	3	3473
Fuel oil No. 1, <i>see</i>	–	3	1223
Fumaroyl dichloride, <i>see</i>	–	8	1780
FUMARYL CHLORIDE	–	8	1780
FUMIGATED CARGO TRANSPORT UNIT	–	9	3359
FURALDEHYDES	–	6.1	1199
FURAN	–	3	2389
2-Furanmethylamine, <i>see</i>	–	3	2526
Furathiocarb (ISO), <i>see</i> CARBAMATE PESTICIDE	P	–	–
Furfuran, <i>see</i>	–	3	2389
FURFURYL ALCOHOL	–	6.1	2874
FURFURYLAMINE	–	3	2526
<i>alpha</i> -Furfurylamine, <i>see</i>	–	3	2526
2-Furyl carbinol, <i>see</i>	–	6.1	2874
FUSE, DETONATING metal-clad	–	1.1D	0290
FUSE, DETONATING metal-clad	–	1.2D	0102
FUSE, DETONATING, MILD EFFECT, metal-clad	–	1.4D	0104
FUSE, IGNITER tubular, metal-clad	–	1.4G	0103
FUSEL OIL	–	3	1201
FUSE, NON-DETONATING	–	1.3G	0101
FUSE, SAFETY	–	1.4S	0105
Fuze, combination, percussion or time, <i>see</i> FUZES, DETONATING or FUZES, IGNITING	–	–	–
FUZES, DETONATING	–	1.1B	0106
FUZES, DETONATING	–	1.2B	0107
FUZES, DETONATING	–	1.4B	0257
FUZES, DETONATING	–	1.4S	0367

Substance, material or article	MP	Class	UN No.
FUZES, DETONATING with protective features	–	1.1D	0408
FUZES, DETONATING with protective features	–	1.2D	0409
FUZES, DETONATING with protective features	–	1.4D	0410
FUZES, IGNITING	–	1.3G	0316
FUZES, IGNITING	–	1.4G	0317
FUZES, IGNITING	–	1.4S	0368
GALLIUM	–	8	2803
GAS CARTRIDGES without a release device, non-refillable	–	2	2037
Gas drips, hydrocarbon, <i>see</i> HYDROCARBONS, LIQUID, N.O.S.	–	–	–
GAS OIL	–	3	1202
GASOLINE	–	3	1203
Gasoline, casinghead, <i>see</i>	–	3	1203
GAS, REFRIGERATED LIQUID, FLAMMABLE, N.O.S.	–	2.1	3312
GAS, REFRIGERATED LIQUID, N.O.S.	–	2.2	3158
GAS, REFRIGERATED LIQUID, OXIDIZING, N.O.S.	–	2.2	3311
GAS SAMPLE, NON-PRESSURIZED, FLAMMABLE, N.O.S., not refrigerated liquid	–	2.1	3167
GAS SAMPLE, NON-PRESSURIZED, TOXIC, FLAMMABLE, N.O.S., not refrigerated liquid	–	2.3	3168
GAS SAMPLE, NON-PRESSURIZED, TOXIC, N.O.S., not refrigerated liquid	–	2.3	3169
Gelatin, blasting, <i>see</i>	–	1.1D	0081
Gelatin dynamite, <i>see</i>	–	1.1D	0081
GENETICALLY MODIFIED MICROORGANISMS	–	9	3245
GENETICALLY MODIFIED ORGANISMS	–	9	3245
GERMANE	–	2.3	2192
Germanium hydride, <i>see</i>	–	2.3	2192
GLYCEROL <i>alpha</i> -MONOCHLOROHYDRIN	–	6.1	2689
Glycerol 1,3-dichlorohydrin, <i>see</i>	–	6.1	2750
Glycerol trinitrate (class 1), <i>see</i> NITROGLYCERIN (class 1)	–	–	–
Glyceryl trinitrate, <i>see</i>	–	3	1204
Glyceryl trinitrate (class 1), <i>see</i> NITROGLYCERIN (class 1)	–	–	–
Glycidal, <i>see</i>	–	3	2622
GLYCIDALDEHYDE	–	3	2622
Glycol chlorohydrin, <i>see</i>	–	6.1	1135
Glycol dimethyl ether, <i>see</i>	–	3	2252
GRENADES hand or rifle, with bursting charge	–	1.1D	0284
GRENADES hand or rifle, with bursting charge	–	1.1F	0292
GRENADES hand or rifle, with bursting charge	–	1.2D	0285
GRENADES hand or rifle, with bursting charge	–	1.2F	0293
Grenades, illuminating, <i>see</i> AMMUNITION, ILLUMINATING	–	–	–
GRENADES, PRACTICE hand or rifle	–	1.2G	0372
GRENADES, PRACTICE hand or rifle	–	1.3G	0318



Index

Substance, material or article	MP	Class	UN No.
GRENADES, PRACTICE hand or rifle	–	1.4G	0452
GRENADES, PRACTICE hand or rifle	–	1.4S	0110
Grenades, smoke, see AMMUNITION, SMOKE	–	–	–
Grignard solution, see	–	4.3	1928
GUANIDINE NITRATE	–	5.1	1467
GUANYL NITROSAMINOQUANYLIDENEHYDRAZINE, WETTED with not less than 30% water, by mass	–	1.1A	0113
GUANYL NITROSAMINOQUANYLTETRAZENE, WETTED with not less than 30% water, or mixture of alcohol and water, by mass	–	1.1A	0114
GUNPOWDER, COMPRESSED	–	1.1D	0028
GUNPOWDER granular, or as a meal	–	1.1D	0027
GUNPOWDER IN PELLETS	–	1.1D	0028
HAFNIUM POWDER, DRY	–	4.2	2545
HAFNIUM POWDER, WETTED with not less than 25% water (a visible excess of water must be present) (a) mechanically produced, particle size less than 53 microns	–	4.1	1326
HAFNIUM POWDER, WETTED with not less than 25% water (a visible excess of water must be present) (b) chemically produced, particle size less than 840 microns	–	4.1	1326
HAY	–	4.1	1327
HEATING OIL, LIGHT	–	3	1202
Heavy hydrogen, see	–	2.1	1957
Heavy hydrogen, compressed, see	–	2.1	1957
HELIUM, COMPRESSED	–	2.2	1046
HELIUM, REFRIGERATED LIQUID	–	2.2	1963
Hemp, dry, see	–	4.1	3360
Heptachlor, see ORGANOCHLORINE PESTICIDE	P	–	–
HEPTAFLUOROPROPANE	–	2.2	3296
<i>n</i> -HEPTALDEHYDE	–	3	3056
Heptanal, see	–	3	3056
HEPTANES	–	3	1206
2-Heptanone, see	–	3	1110
4-Heptanone, see	–	3	2710
<i>n</i> -HEPTENE	–	3	2278
Heptenophos, see ORGANOPHOSPHORUS PESTICIDE	P	–	–
Heptyl aldehyde, see	–	3	3056
Heptylbenzene, see	P	9	3082
Heptyl chloride, see	P	3	1993
HETP, see	P	6.1	1611
HETP (and compressed gas, mixtures), see	–	2.3	1612
HEXACHLOROACETONE	–	6.1	2661
HEXACHLOROBENZENE	–	6.1	2729
HEXACHLOROBUTADIENE	P	6.1	2279

Substance, material or article	MP	Class	UN No.
Hexachloro-1,3-butadiene, <i>see</i>	P	6.1	2279
1,3-Hexachlorobutadiene, <i>see</i>	P	6.1	2279
HEXACHLOROCYCLOPENTADIENE	–	6.1	2646
Hexachlorophane, <i>see</i>	–	6.1	2875
HEXACHLOROPHENE	–	6.1	2875
Hexachloro-2-propanone, <i>see</i>	–	6.1	2661
HEXADECYLTRICHLOROSILANE	–	8	1781
1,3-Hexadiene, <i>see</i>	–	3	2458
1,4-Hexadiene, <i>see</i>	–	3	2458
1,5-Hexadiene, <i>see</i>	–	3	2458
2,4-Hexadiene, <i>see</i>	–	3	2458
HEXADIENES	–	3	2458
HEXAETHYL TETRAPHOSPHATE	P	6.1	1611
HEXAETHYL TETRAPHOSPHATE AND COMPRESSED GAS MIXTURE	–	2.3	1612
HEXAFLUOROACETONE	–	2.3	2420
HEXAFLUOROACETONE HYDRATE, LIQUID	–	6.1	2552
HEXAFLUOROACETONE HYDRATE, SOLID	–	6.1	3436
HEXAFLUROETHANE	–	2.2	2193
HEXAFLUOROPHOSPHORIC ACID	–	8	1782
Hexafluoro-2-propanone, <i>see</i>	–	2.3	2420
HEXAFLUOROPROPYLENE	–	2.2	1858
Hexahydrobenzene, <i>see</i>	–	3	1145
Hexahydrocresol, <i>see</i>	–	3	2617
Hexahydromethylphenol, <i>see</i>	–	3	2617
Hexahydropyridine, <i>see</i>	–	8	2401
Hexahydrothiophenol, <i>see</i>	–	3	3054
Hexahydrotoluene, <i>see</i>	–	3	2296
HEXALDEHYDE	–	3	1207
Hexamethylene, <i>see</i>	–	3	1145
HEXAMETHYLENEDIAMINE, MOLTEN	–	8	2280
HEXAMETHYLENEDIAMINE, SOLID	–	8	2280
HEXAMETHYLENEDIAMINE SOLUTION	–	8	1783
HEXAMETHYLENE DIISOCYANATE	–	6.1	2281
HEXAMETHYLENEIMINE	–	3	2493
HEXAMETHYLENETETRAMINE	–	4.1	1328
Hexamine, <i>see</i>	–	4.1	1328
Hexane, <i>see</i>	–	3	1208
1,6-Hexanediamine, solid, <i>see</i>	–	8	2280
1,6-Hexanediamine solution, <i>see</i>	–	8	1783
HEXANES	–	3	1208
HEXANITRODIPHENYLAMINE	–	1.1D	0079
Hexanitrodiphenyl sulphide, wetted, <i>see</i>	–	4.1	2852
HEXANITROSTILBENE	–	1.1D	0392

Index

Substance, material or article	MP	Class	UN No.
Hexanoic acid, <i>see</i>	–	8	2829
HEXANOLS	–	3	2282
1-HEXENE	–	3	2370
HEXOGEN AND CYCLOTETRAMETHYLENETETRANITRAMINE MIXTURE, DESENSITIZED with not less than 10% phlegmatizer, by mass	–	1.1D	0391
HEXOGEN AND CYCLOTETRAMETHYLENETETRANITRAMINE MIXTURE, WETTED with not less than 15% water, by mass	–	1.1D	0391
HEXOGEN AND HMX MIXTURE, DESENSITIZED with not less than 10% phlegmatizer, by mass	–	1.1D	0391
HEXOGEN AND HMX MIXTURE, WETTED with not less than 15% water, by mass	–	1.1D	0391
HEXOGEN AND OCTOGEN MIXTURE, DESENSITIZED with not less than 10% phlegmatizer, by mass	–	1.1D	0391
HEXOGEN AND OCTOGEN MIXTURE, WETTED with not less than 15% water, by mass	–	1.1D	0391
HEXOGEN, DESENSITIZED	–	1.1D	0483
HEXOGEN, WETTED with not less than 15% water, by mass	–	1.1D	0072
Hexoic acid, <i>see</i>	–	8	2829
HEXOLITE dry or wetted with less than 15% water, by mass	–	1.1D	0118
Hexone, <i>see</i>	–	3	1245
HEXOTOL dry or wetted with less than 15% water, by mass	–	1.1D	0118
HEXOTONAL	–	1.1D	0393
HEXOTONAL cast, <i>see</i>	–	1.1D	0393
HEXYL	–	1.1D	0079
Hexyl acetate, <i>see</i>	–	3	1233
Hexyl aldehyde, <i>see</i>	–	3	1207
Hexylbenzene, <i>see</i>	P	9	3082
Hexyl chloride, <i>see</i>	P	3	1993
<i>alpha</i> -Hexylene, <i>see</i>	–	3	2370
Hexylic acid, <i>see</i>	–	8	2829
<i>tert</i> -Hexyl peroxyneodecanoate (concentration ≤71%, with diluent Type A), <i>see</i>	–	5.2	3115
<i>tert</i> -Hexyl peroxyvalate (concentration ≤72%, with diluent Type B), <i>see</i>	–	5.2	3115
HEXYLTRICHLOROSILANE	–	8	1784
HMDI, <i>see</i>	–	6.1	2281
HMX, DESENSITIZED	–	1.1D	0484
HMX AND RDX MIXTURE, WETTED with not less than 15% water, by mass	–	1.1D	0319
HMX AND RDX MIXTURE, DESENSITIZED with not less than 10% phlegmatizer, by mass	–	1.1D	0319
HMX, WETTED with not less than 15% water, by mass	–	1.1D	0226
HYDRAZINE, ANHYDROUS	–	8	2029
HYDRAZINE AQUEOUS SOLUTION, FLAMMABLE with more than 37% hydrazine, by mass	–	8	3484

Substance, material or article	MP	Class	UN No.
HYDRAZINE, AQUEOUS SOLUTION with more than 37% hydrazine, by mass	–	8	2030
HYDRAZINE, AQUEOUS SOLUTION with not more than 37% hydrazine, by mass	–	6.1	3293
Hydrazine base, aqueous solution, <i>see</i>	–	6.1	3293
Hydrazine hydrate, <i>see</i>	–	8	2030
Hydrazinobenzene, <i>see</i>	–	6.1	2572
Hydrides, metal, water-reactive, N.O.S., <i>see</i>	–	4.3	1409
HYDRIODIC ACID	–	8	1787
Hydriodic acid, anhydrous, <i>see</i>	–	2.3	2197
HYDROBROMIC ACID	–	8	1788
HYDROCARBON GAS MIXTURE, COMPRESSED, N.O.S.	–	2.1	1964
HYDROCARBON GAS MIXTURE, LIQUEFIED, N.O.S.	–	2.1	1965
HYDROCARBON GAS REFILLS FOR SMALL DEVICES with release device	–	2.1	3150
HYDROCARBONS, LIQUID, N.O.S.	–	3	3295
HYDROCHLORIC ACID	–	8	1789
Hydrocyanic acid, anhydrous, stabilized, containing less than 3% water, <i>see</i>	P	6.1	1051
Hydrocyanic acid, anhydrous, stabilized, containing less than 3% water and absorbed in a porous inert material, <i>see</i>	P	6.1	1614
HYDROCYANIC ACID, AQUEOUS SOLUTION with not more than 20% hydrogen cyanide	P	6.1	1613
HYDROCYANIC ACID with more than 20%, acid by mass (transport prohibited)	–	–	–
HYDROFLUORIC ACID AND SULPHURIC ACID MIXTURE	–	8	1786
Hydrofluoric acid, anhydrous, <i>see</i>	–	8	1052
HYDROFLUORIC ACID solution, with more than 60% hydrogen fluoride	–	8	1790
HYDROFLUORIC ACID solution, with not more than 60% hydrogen fluoride	–	8	1790
Hydrofluoroboric acid, <i>see</i>	–	8	1775
Hydrofluorosilicic acid, <i>see</i>	–	8	1778
HYDROGEN AND METHANE MIXTURE, COMPRESSED	–	2.1	2034
Hydrogen antimonide, <i>see</i>	–	2.3	2676
Hydrogen arsenide, <i>see</i>	–	2.3	2188
Hydrogen bromide, <i>see</i>	–	8	1788
HYDROGEN BROMIDE, ANHYDROUS	–	2.3	1048
Hydrogen bromide solution, <i>see</i>	–	8	1788
Hydrogen carboxylic acid, <i>see</i>	–	8	1779
Hydrogen chloride, <i>see</i>	–	8	1789
HYDROGEN CHLORIDE, ANHYDROUS	–	2.3	1050
HYDROGEN CHLORIDE, REFRIGERATED LIQUID (transport prohibited)	–	2.3	2186
HYDROGEN, COMPRESSED	–	2.1	1049
HYDROGEN CYANIDE, AQUEOUS SOLUTION with not more than 20% hydrogen cyanide	P	6.1	1613

Index

Substance, material or article	MP	Class	UN No.
HYDROGEN CYANIDE, SOLUTION IN ALCOHOL with more than 45% hydrogen cyanide (transport prohibited)	–	–	–
HYDROGEN CYANIDE, SOLUTION IN ALCOHOL with not more than 45% hydrogen cyanide	P	6.1	3294
HYDROGEN CYANIDE, STABILIZED containing less than 3% water	P	6.1	1051
HYDROGEN CYANIDE, STABILIZED containing less than 3% water and absorbed in a porous inert material	P	6.1	1614
HYDROGENDIFLUORIDES, SOLID, N.O.S.	–	8	1740
HYDROGENDIFLUORIDES SOLUTION, N.O.S.	–	8	3471
Hydrogen fluoride, see	–	8	1790
HYDROGEN FLUORIDE, ANHYDROUS	–	8	1052
HYDROGEN IN A METAL HYDRIDE STORAGE SYSTEM	–	2.1	3468
HYDROGEN IN A METAL HYDRIDE STORAGE SYSTEM CONTAINED IN EQUIPMENT	–	2.1	3468
HYDROGEN IN A METAL HYDRIDE STORAGE SYSTEM PACKED WITH EQUIPMENT	–	2.1	3468
Hydrogen iodide, see	–	8	1787
HYDROGEN IODIDE, ANHYDROUS	–	2.3	2197
HYDROGEN PEROXIDE AND PEROXYACETIC ACID MIXTURE with acid(s), water and not more than 5% peroxyacetic acid, STABILIZED	–	5.1	3149
HYDROGEN PEROXIDE, AQUEOUS SOLUTION, STABILIZED with more than 60% hydrogen peroxide	–	5.1	2015
HYDROGEN PEROXIDE, AQUEOUS SOLUTION with not less than 8% but less than 20% hydrogen peroxide (stabilized as necessary)	–	5.1	2984
HYDROGEN PEROXIDE, AQUEOUS SOLUTION with not less than 20% but not more than 60% hydrogen peroxide (stabilized as necessary)	–	5.1	2014
Hydrogen peroxide carbamide, solid, see	–	5.1	1511
HYDROGEN PEROXIDE, STABILIZED	–	5.1	2015
Hydrogen phosphide, see	–	2.3	2199
HYDROGEN, REFRIGERATED LIQUID	–	2.1	1966
HYDROGEN SELENIDE, ANHYDROUS	–	2.3	2202
Hydrogen silicide, compressed, see	–	2.1	2203
Hydrogen sulphates, aqueous solution, see	–	8	2837
HYDROGEN SULPHIDE	–	2.3	1053
Hydroselenic acid, anhydrous, see	–	2.3	2202
Hydrosilicofluoric acid, see	–	8	1778
1-HYDROXYBENZOTRIAZOLE, ANHYDROUS, dry or wetted with less than 20% water, by mass	–	1.3C	0508
1-HYDROXYBENZOTRIAZOLE MONOHYDRATE	–	4.1	3474
3-Hydroxybutanal, see	–	6.1	2839
3-Hydroxybutan-2-one, see	–	3	2621
3-Hydroxybutyraldehyde, see	–	6.1	2839
2-Hydroxycamphane, see	–	4.1	1312
Hydroxydimethylbenzenes, liquid, see	–	6.1	3430
Hydroxydimethylbenzenes, solid, see	–	6.1	2261

Substance, material or article	MP	Class	UN No.
3-Hydroxy-1,1-dimethylbutyl peroxyneodecanoate (concentration ≤52%, as a stable dispersion in water)	–	5.2	3119
3-Hydroxy-1,1-dimethylbutyl peroxyneodecanoate (concentration ≤52%, with diluent Type A)	–	5.2	3117
3-Hydroxy-1,1-dimethylbutyl peroxyneodecanoate (concentration ≤77%, with diluent Type A)	–	5.2	3115
2-(2-Hydroxyethoxy)-1-(pyrrolidin-1-yl)benzene-4-diazonium zinc chloride (concentration 100%), see	–	4.1	3236
3-(2-Hydroxyethoxy)-4-(pyrrolidin-1-yl)benzenediazonium zinc chloride (concentration 100%), see	–	4.1	3236
2-Hydroxyethylamine, see	–	8	2491
HYDROXYLAMINE SULPHATE	–	8	2865
Hydroxylammonium sulphate, see	–	8	2865
1-Hydroxy-3-methyl-2-penten-4-yne, see	–	8	2705
3-Hydroxyphenol, see	–	6.1	2876
HYPOCHLORITES, INORGANIC, N.O.S.	–	5.1	3212
HYPOCHLORITE SOLUTION	–	8	1791
IGNITERS	–	1.1G	0121
IGNITERS	–	1.2G	0314
IGNITERS	–	1.3G	0315
IGNITERS	–	1.4G	0325
IGNITERS	–	1.4S	0454
Imazalil, see PESTICIDE, N.O.S.	–	–	–
3,3'-IMINODIPROPYLAMINE	–	8	2269
INFECTIOUS SUBSTANCE, AFFECTING ANIMALS only	–	6.2	2900
INFECTIOUS SUBSTANCE, AFFECTING HUMANS	–	6.2	2814
Inflammable ... , see FLAMMABLE ...	–	–	–
INSECTICIDE GAS, FLAMMABLE, N.O.S.	–	2.1	3354
INSECTICIDE GAS, N.O.S.	–	2.2	1968
INSECTICIDE GAS, TOXIC, FLAMMABLE, N.O.S.	–	2.3	3355
INSECTICIDE GAS, TOXIC, N.O.S.	–	2.3	1967
IODINE	–	8	3495
IODINE MONOCHLORIDE, LIQUID	–	8	3498
IODINE MONOCHLORIDE, SOLID	–	8	1792
IODINE PENTAFLUORIDE	–	5.1	2495
2-IODOBUTANE	–	3	2390
Iodomethane, see	–	6.1	2644
IODOMETHYLPROPANES	–	3	2391
IODOPROPANES	–	3	2392
<i>alpha</i> -Iodotoluene, see	–	6.1	2653
loxynil, see PESTICIDE, N.O.S.	P	–	–
lprobenfos, see ORGANOPHOSPHORUS PESTICIDE	–	–	–
Iron carbonyl, see	–	6.1	1994
Iron chloride, anhydrous, see	–	8	1773
Iron(III) chloride, anhydrous, see	–	8	1773

Index

Substance, material or article	MP	Class	UN No.
Iron chloride solution, <i>see</i>	–	8	2582
IRON OXIDE, SPENT obtained from coal gas purification	–	4.2	1376
IRON PENTACARBONYL	–	6.1	1994
Iron perchloride, anhydrous, <i>see</i>	–	8	1773
Iron perchloride solution, <i>see</i>	–	8	2582
Iron powder, <i>see</i>	–	4.2	1383
Iron powder, pyrophoric, <i>see</i>	–	4.2	1383
IRON SPONGE, SPENT obtained from coal gas purification	–	4.2	1376
Iron swarf, <i>see</i>	–	4.2	2793
Iron trichloride, anhydrous, <i>see</i>	–	8	1773
Iron trichloride solution, <i>see</i>	–	8	2582
Isoamyl acetate, <i>see</i>	–	3	1104
Isoamyl alcohol, <i>see</i>	–	3	1105
Isoamyl bromide, <i>see</i>	–	3	2341
Isoamyl butyrate, <i>see</i>	–	3	2620
<i>alpha</i> -Isoamylene, <i>see</i>	–	3	2561
Isoamyl formate, <i>see</i>	–	3	1109
Isoamyl mercaptan, <i>see</i>	–	3	1111
Isoamyl nitrate, <i>see</i>	–	3	1112
Isoamyl nitrite, <i>see</i>	–	3	1113
Isobenzan, <i>see</i> ORGANOCHLORINE PESTICIDE	P	–	–
Isobutanal, <i>see</i>	–	3	2045
ISOBUTANE	–	2.1	1969
ISOBUTANOL	–	3	1212
Isobutene, <i>see</i>	–	2.1	1055
Isobutenol, <i>see</i>	–	3	2614
Isobutenyl chloride, <i>see</i>	–	3	2554
ISOBUTYL ACETATE	–	3	1213
ISOBUTYL ACRYLATE, STABILIZED	–	3	2527
ISOBUTYL ALCOHOL	–	3	1212
ISOBUTYL ALDEHYDE	–	3	2045
ISOBUTYLAMINE	–	3	1214
Isobutylbenzene, <i>see</i>	–	3	2709
Isobutyl bromide, <i>see</i>	–	3	2342
ISOBUTYLENE	–	2.1	1055
ISOBUTYL FORMATE	–	3	2393
Isobutyl iodide, <i>see</i>	–	3	2391
ISOBUTYL ISOBUTYRATE	–	3	2528
ISOBUTYL ISOCYANATE	–	6.1	2486
Isobutyl mercaptan, <i>see</i>	–	3	2347
ISOBUTYL METHACRYLATE, STABILIZED	–	3	2283
ISOBUTYL PROPIONATE	–	3	2394
Isobutyl vinyl ether, <i>see</i>	–	3	1304

Substance, material or article	MP	Class	UN No.
ISOBUTYRALDEHYDE	–	3	2045
ISOBUTYRIC ACID	–	3	2529
ISOBUTYRONITRILE	–	3	2284
ISOBUTYRYL CHLORIDE	–	3	2395
ISOCYANATES, FLAMMABLE, TOXIC, N.O.S.	–	3	2478
ISOCYANATE SOLUTION, FLAMMABLE, TOXIC, N.O.S.	–	3	2478
ISOCYANATE SOLUTION, TOXIC, FLAMMABLE, N.O.S.	–	6.1	3080
ISOCYANATE SOLUTION, TOXIC, N.O.S.	–	6.1	2206
ISOCYANATES, TOXIC, FLAMMABLE, N.O.S.	–	6.1	3080
ISOCYANATES, TOXIC, N.O.S.	–	6.1	2206
ISOCYANATOBENZOTRIFLUORIDES	–	6.1	2285
3-Isocyanatomethyl-3,5,5-trimethylcyclohexyl isocyanate, <i>see</i>	–	6.1	2290
Isodecyl acrylate, <i>see</i>	P	9	3082
Isododecane, <i>see</i>	–	3	2286
Isodrin, <i>see</i> ORGANOCHLORINE PESTICIDE	–	–	–
Isufenphos, <i>see</i> ORGANOPHOSPHORUS PESTICIDE	P	–	–
ISOHEPTENES	–	3	2287
ISOHEXENES	–	3	2288
Isolan, <i>see</i> CARBAMATE PESTICIDE	–	–	–
Isooctaldehyde, <i>see</i>	–	3	1191
Isooctane, <i>see</i>	–	3	1262
ISOOCTENES	–	3	1216
Isooctyl nitrate, <i>see</i>	P	9	3082
Isopentane, <i>see</i>	–	3	1265
ISOPENTENES	–	3	2371
Isopentylamine, <i>see</i>	–	3	1106
Isopentyl nitrite, <i>see</i>	–	3	1113
ISOPHORONEDIAMINE	–	8	2289
ISOPHORONE DIISOCYANATE	–	6.1	2290
ISOPRENE, STABILIZED	–	3	1218
Isoprocarb, <i>see</i> CARBAMATE PESTICIDE	P	–	–
ISOPROPANOL	–	3	1219
ISOPROPENYL ACETATE	–	3	2403
ISOPROPENYLBENZENE	–	3	2303
Isopropenyl carbinol, <i>see</i>	–	3	2614
Isopropenyl chloride, <i>see</i>	–	3	2456
2-Isopropoxypropane, <i>see</i>	–	3	1159
ISOPROPYL ACETATE	–	3	1220
ISOPROPYL ACID PHOSPHATE	–	8	1793
ISOPROPYL ALCOHOL	–	3	1219
ISOPROPYLAMINE	–	3	1221
ISOPROPYLBENZENE	–	3	1918
Isopropyl bromide, <i>see</i>	–	3	2344



Index

Substance, material or article	MP	Class	UN No.
Isopropyl sec-butyl peroxydicarbonate (concentration $\leq 32\%$ ) with di-sec-butyl peroxydicarbonate (concentration $\leq 15-18\%$ ) and di-isopropyl peroxydicarbonate (concentration $\leq 12-15\%$ ), with diluent Type A, see	–	5.2	3115
Isopropyl sec-butyl peroxydicarbonate (concentration $\leq 52\%$ ) with di-sec-butyl peroxydicarbonate (concentration $\leq 28\%$ ) and di-isopropyl peroxydicarbonate (concentration $\leq 22\%$ ), see	–	5.2	3111
ISOPROPYL BUTYRATE	–	3	2405
Isopropyl carbinol, see	–	3	1212
Isopropyl chloride, see	–	3	2356
ISOPROPYL CHLOROACETATE	–	3	2947
Isopropyl chlorocarbonate, see	–	6.1	2407
ISOPROPYL CHLOROFORMATE	–	6.1	2407
Isopropyl chloromethanoate, see	–	6.1	2407
ISOPROPYL 2-CHLOROPROPIONATE	–	3	2934
<i>alpha</i> -Isopropyl <i>alpha</i> -chloropropionate, see	–	3	2934
Isopropylcumyl hydroperoxide (concentration $\leq 72\%$ , with diluent Type A), see	–	5.2	3109
Isopropyl cyanide, see	–	3	2284
Isopropyl ether, see	–	3	1159
Isopropylethylene, see	–	3	2561
Isopropyl formate, see	–	3	1281
Isopropylideneacetone, see	–	3	1229
ISOPROPYL ISOBUTYRATE	–	3	2406
ISOPROPYL ISOCYANATE	–	6.1	2483
Isopropyl mercaptan, see	–	3	2402
Isopropyl methanoate, see	–	3	1281
ISOPROPYL NITRATE	–	3	1222
ISOPROPYL PROPIONATE	–	3	2409
Isopropyltoluene, see	P	3	2046
Isopropyltoluol, see	P	3	2046
ISOSORBIDE-5-MONONITRATE	–	4.1	3251
ISOSORBIDE DINITRATE MIXTURE with not less than 60% lactose, mannose, starch, or calcium hydrogen phosphate	–	4.1	2907
Isotetramethylbenzene, see	P	9	3082
Isothioate, see ORGANOPHOSPHORUS PESTICIDE	–	–	–
Isovaleraldehyde, see	–	3	2058
Isovalerone, see	–	3	1157
Isoxathion, see ORGANOPHOSPHORUS PESTICIDE	P	–	–
JET PERFORATING GUNS, CHARGED oil well, without detonator	–	1.1D	0124
JET PERFORATING GUNS, CHARGED oil well, without detonator	–	1.4D	0494
Jet tappers, without detonator, see CHARGES, SHAPED, COMMERCIAL	–	–	–
Jute, dry, see	–	4.1	3360

Substance, material or article	MP	Class	UN No.
Kapok, dry, <i>see</i>	–	4.1	3360
Kelevan, <i>see</i> PESTICIDE, N.O.S.	–	–	–
KEROSENE	–	3	1223
Kerosine, <i>see</i>	–	3	1223
KETONES, LIQUID, N.O.S.	–	3	1224
KRILL MEAL	–	4.2	3497
KRYPTON, COMPRESSED	–	2.2	1056
KRYPTON, REFRIGERATED LIQUID	–	2.2	1970
Lacquer, <i>see</i> PAINT	–	–	–
Lacquer base, liquid, <i>see</i> PAINT	–	–	–
Lacquer base solution, <i>see</i>	–	3	2059
LEAD ACETATE	P	6.1	1616
Lead and zinc calcines, <i>see</i>	P	6.1	2291
LEAD ARSENATES	P	6.1	1617
LEAD ARSENITES	P	6.1	1618
LEAD AZIDE, WETTED with not less than 20% water, or mixture of alcohol and water, by mass	–	1.1A	0129
Lead chloride, solid, <i>see</i>	P	6.1	2291
LEAD COMPOUND, SOLUBLE, N.O.S.	P	6.1	2291
LEAD CYANIDE	P	6.1	1620
LEAD DIOXIDE	–	5.1	1872
Lead dross, <i>see</i>	–	8	1794
Lead(II) acetate, <i>see</i>	–	6.1	1616
Lead(II) cyanide, <i>see</i>	–	6.1	1620
LEAD NITRATE	P	5.1	1469
Lead(II) nitrate, <i>see</i> LEAD NITRATE	–	–	–
Lead(II) perchlorate, <i>see</i>	–	5.1	1470
LEAD PERCHLORATE, SOLID	P	5.1	1470
LEAD PERCHLORATE SOLUTION	P	5.1	3408
Lead peroxide, <i>see</i>	–	5.1	1872
LEAD PHOSPHITE, DIBASIC	–	4.1	2989
LEAD STYPHNATE, WETTED with not less than 20% water, or mixture of alcohol and water, by mass	–	1.1A	0130
LEAD SULPHATE with more than 3% free acid	–	8	1794
Lead tetraethyl, <i>see</i>	P	6.1	1649
Lead tetramethyl, <i>see</i>	P	6.1	1649
LEAD TRINITRORESORCINATE, WETTED with not less than 20% water, or mixture of alcohol and water, by mass	–	1.1A	0130
LIFE-SAVING APPLIANCES, NOT SELF-INFLATING containing dangerous goods as equipment	–	9	3072
LIFE-SAVING APPLIANCES, SELF-INFLATING	–	9	2990
LIGHTER REFILLS containing flammable gas	–	2.1	1057
LIGHTERS containing flammable gas	–	2.1	1057

Index

Substance, material or article	MP	Class	UN No.
LIGHTERS, FUSE	–	1.4S	0131
Ligroin, <i>see</i> PETROLEUM DISTILLATES, N.O.S. <i>or see</i> PETROLEUM PRODUCTS, N.O.S.	–	–	–
Limonene, <i>see</i>	P	3	2052
Lindane, <i>see</i> ORGANOCHLORINE PESTICIDE	P	–	–
Linuron, <i>see</i> <b>Note 1</b>	P	–	–
LIQUEFIED GASES non-flammable, charged with nitrogen, carbon dioxide or air	–	2.2	1058
LIQUEFIED GAS, FLAMMABLE, N.O.S.	–	2.1	3161
LIQUEFIED GAS, N.O.S.	–	2.2	3163
LIQUEFIED GAS, OXIDIZING, N.O.S.	–	2.2	3157
LIQUEFIED GAS, TOXIC, CORROSIVE, N.O.S.	–	2.3	3308
LIQUEFIED GAS, TOXIC, FLAMMABLE, CORROSIVE, N.O.S.	–	2.3	3309
LIQUEFIED GAS, TOXIC, FLAMMABLE, N.O.S.	–	2.3	3160
LIQUEFIED GAS, TOXIC, N.O.S.	–	2.3	3162
LIQUEFIED GAS, TOXIC, OXIDIZING, CORROSIVE, N.O.S.	–	2.3	3310
LIQUEFIED GAS, TOXIC, OXIDIZING, N.O.S.	–	2.3	3307
Liquefied petroleum gases, <i>see</i>	–	2.1	1075
Liquified natural gas, <i>see</i>	–	2.1	1972
LITHIUM	–	4.3	1415
Lithium alkyls, liquid, <i>see</i>	–	4.2	3394
Lithium alkyls, solid, <i>see</i>	–	4.2	3393
Lithium alloy (liquid), <i>see</i>	–	2.1	1001
LITHIUM ALUMINIUM HYDRIDE	–	4.3	1410
LITHIUM ALUMINIUM HYDRIDE, ETHEREAL	–	4.3	1411
Lithium amalgams, liquid, <i>see</i>	–	4.3	1389
Lithium amalgams, solid, <i>see</i>	–	4.3	3401
Lithium amide, <i>see</i>	–	4.3	1390
LITHIUM BOROHYDRIDE	–	4.3	1413
Lithium dispersions, <i>see</i>	–	4.3	1391
LITHIUM FERROSILICON	–	4.3	2830
LITHIUM HYDRIDE	–	4.3	1414
LITHIUM HYDRIDE, FUSED SOLID	–	4.3	2805
LITHIUM HYDROXIDE	–	8	2680
Lithium hydroxide, solid, <i>see</i>	–	8	2680
LITHIUM HYDROXIDE SOLUTION	–	8	2679
LITHIUM HYPOCHLORITE, DRY	–	5.1	1471
LITHIUM HYPOCHLORITE MIXTURE	–	5.1	1471
Lithium in cartouches, <i>see</i>	–	4.3	1415
LITHIUM ION BATTERIES (including lithium ion polymer batteries)	–	9	3480
LITHIUM ION BATTERIES CONTAINED IN EQUIPMENT (including lithium ion polymer batteries)	–	9	3481
LITHIUM ION BATTERIES PACKED WITH EQUIPMENT (including lithium ion polymer batteries)	–	9	3481

Substance, material or article	MP	Class	UN No.
LITHIUM METAL BATTERIES (including lithium alloy batteries)	–	9	3090
LITHIUM METAL BATTERIES CONTAINED IN EQUIPMENT (including lithium alloy batteries)	–	9	3091
LITHIUM METAL BATTERIES PACKED WITH EQUIPMENT (including lithium alloy batteries)	–	9	3091
LITHIUM NITRATE	–	5.1	2722
LITHIUM NITRIDE	–	4.3	2806
LITHIUM PEROXIDE	–	5.1	1472
Lithium silicide, <i>see</i>	–	4.3	1417
LITHIUM SILICON	–	4.3	1417
LNG, <i>see</i>	–	2.1	1972
LONDON PURPLE	P	6.1	1621
LPG, <i>see</i>	–	2.1	1075
Lye, <i>see</i>	–	8	1823
M86 fuel, <i>see</i>	–	3	3165
MAGNESIUM	–	4.1	1869
Magnesium alkyls, <i>see</i>	–	4.2	3394
Magnesium alloys, <i>see</i>	–	4.3	1393
MAGNESIUM ALLOYS POWDER	–	4.3	1418
MAGNESIUM ALLOYS with more than 50% magnesium in pellets, turnings or ribbons	–	4.1	1869
MAGNESIUM ALUMINIUM PHOSPHIDE	–	4.3	1419
Magnesium amalgams, liquid, <i>see</i>	–	4.3	1392
Magnesium amalgams, solid, <i>see</i>	–	4.3	3402
MAGNESIUM ARSENATE	P	6.1	1622
Magnesium bisulphite solution, <i>see</i>	–	8	2693
MAGNESIUM BROMATE	–	5.1	1473
MAGNESIUM CHLORATE	–	5.1	2723
Magnesium chloride and chlorate mixture, <i>see</i>	–	5.1	1459
MAGNESIUM DIAMIDE	–	4.2	2004
Magnesium diphenyl, <i>see</i>	–	4.2	3393
Magnesium dispersions, <i>see</i>	–	4.3	1391
MAGNESIUM FLUOROSILICATE	–	6.1	2853
MAGNESIUM GRANULES, COATED particle size not less than 149 microns	–	4.3	2950
Magnesium hexafluorosilicate, <i>see</i>	–	6.1	2853
MAGNESIUM HYDRIDE	–	4.3	2010
MAGNESIUM NITRATE	–	5.1	1474
MAGNESIUM PERCHLORATE	–	5.1	1475
MAGNESIUM PEROXIDE	–	5.1	1476
MAGNESIUM PHOSPHIDE	–	4.3	2011
MAGNESIUM POWDER	–	4.3	1418

Index

Substance, material or article	MP	Class	UN No.
Magnesium scrap, <i>see</i>	–	4.1	1869
MAGNESIUM SILICIDE	–	4.3	2624
Magnesium silicofluoride, <i>see</i>	–	6.1	2853
Magnesium silicon, <i>see</i>	–	4.3	2624
MAGNETIZED MATERIAL	–	9	2807
Malathion, <i>see</i>	P	9	3082
MALEIC ANHYDRIDE	–	8	2215
MALEIC ANHYDRIDE, MOLTEN	–	8	2215
Malonodinitrile, <i>see</i>	–	6.1	2647
MALONONITRILE	–	6.1	2647
Mancozeb (ISO), <i>see</i>	P	9	3077
MANEB	P	4.2	2210
MANEB PREPARATION, STABILIZED against self-heating	P	4.3	2968
MANEB PREPARATION with not less than 60% Maneb	P	4.2	2210
MANEB, STABILIZED	P	4.3	2968
Manganese ethylene-bis-dithiocarbamate, <i>see</i>	P	4.2	2210
Manganese ethylene-1,2-bis-dithiocarbamate, <i>see</i>	P	4.2	2210
Manganese ethylene-bis-dithiocarbamate, stabilized, <i>see</i>	P	4.3	2968
Manganese ethylene-1,2-bis-dithiocarbamate, stabilized, <i>see</i>	P	4.3	2968
MANGANESE NITRATE	–	5.1	2724
Manganese(III) nitrate, <i>see</i>	–	5.1	2724
MANGANESE RESINATE	–	4.1	1330
Manganous nitrate, <i>see</i>	–	5.1	2724
MANNITOL HEXANITRATE, WETTED with not less than 40% water, or mixture of alcohol and water, by mass	–	1.1D	0133
MATCHES, FUSEE	–	4.1	2254
MATCHES, SAFETY (book, card or strike on box)	–	4.1	1944
MATCHES, "STRIKE ANYWHERE"	–	4.1	1331
MATCHES, WAX 'VESTA'	–	4.1	1945
Meal, oily, <i>see</i>	–	4.2	1386
Mecarbam, <i>see</i> ORGANOPHOSPHORUS PESTICIDE	P	–	–
MEDICAL WASTE, N.O.S.	–	6.2	3291
MEDICINE, LIQUID, FLAMMABLE, TOXIC, N.O.S.	–	3	3248
MEDICINE, LIQUID, TOXIC, N.O.S.	–	6.1	1851
MEDICINE, SOLID, TOXIC, N.O.S.	–	6.1	3249
Medinoterb, <i>see</i> SUBSTITUTED NITROPHENOL PESTICIDE	–	–	–
<i>p</i> -Menthyl hydroperoxide (concentration ≤72%, with diluent Type A), <i>see</i>	–	5.2	3109
<i>p</i> -Menthyl hydroperoxide (concentration >72–100%), <i>see</i>	–	5.2	3105
Mephosfolan, <i>see</i> ORGANOPHOSPHORUS PESTICIDE	P	–	–
MERCAPTAN MIXTURE, LIQUID, FLAMMABLE, N.O.S.	–	3	3336
MERCAPTAN MIXTURE, LIQUID, FLAMMABLE, TOXIC, N.O.S.	–	3	1228
MERCAPTAN MIXTURE, LIQUID, TOXIC, FLAMMABLE, N.O.S.	–	6.1	3071
MERCAPTANS, LIQUID, FLAMMABLE, N.O.S.	–	3	3336

Substance, material or article	MP	Class	UN No.
MERCAPTANS, LIQUID, FLAMMABLE, TOXIC, N.O.S.	–	3	1228
MERCAPTANS, LIQUID, TOXIC, FLAMMABLE, N.O.S.	–	6.1	3071
Mercaptoacetic acid, <i>see</i>	–	8	1940
Mercaptodimethur, <i>see</i> CARBAMATE PESTICIDE	P	–	–
2-Mercaptoethanol, <i>see</i>	–	6.1	2966
2-Mercaptopropionic acid, <i>see</i>	–	6.1	2936
5-MERCAPTOTETRAZOL-1-ACETIC ACID	–	1.4C	0448
Mercuric acetate, <i>see</i>	P	6.1	1629
Mercuric ammonium chloride, <i>see</i>	P	6.1	1630
MERCURIC ARSENATE	P	6.1	1623
Mercuric benzoate, <i>see</i>	P	6.1	1631
Mercuric bisulphate, <i>see</i>	P	6.1	1645
Mercuric bromide, <i>see</i>	P	6.1	1634
MERCURIC CHLORIDE	P	6.1	1624
Mercuric cyanide, <i>see</i>	P	6.1	1636
Mercuric gluconate, <i>see</i>	P	6.1	1637
Mercuric iodide, <i>see</i>	P	6.1	1638
MERCURIC NITRATE	P	6.1	1625
Mercuric oleate, <i>see</i>	P	6.1	1640
Mercuric oxide, <i>see</i>	P	6.1	1641
Mercuric oxycyanide, desensitized, <i>see</i>	P	6.1	1642
MERCURIC POTASSIUM CYANIDE	P	6.1	1626
Mercuric sulphate, <i>see</i>	P	6.1	1645
Mercuric thiocyanate, <i>see</i>	P	6.1	1646
Mercuriol, <i>see</i>	P	6.1	1639
Mercurous acetate, <i>see</i>	P	6.1	1629
Mercurous bisulphate, <i>see</i>	P	6.1	1645
Mercurous bromide, <i>see</i>	P	6.1	1634
Mercurous chloride, <i>see</i>	P	9	3077
MERCUROUS NITRATE	P	6.1	1627
Mercurous salicylate, <i>see</i>	P	6.1	1644
Mercurous sulphate, <i>see</i>	P	6.1	1645
MERCURY	–	8	2809
MERCURY ACETATE	P	6.1	1629
MERCURY AMMONIUM CHLORIDE	P	6.1	1630
MERCURY BASED PESTICIDE, LIQUID, FLAMMABLE, TOXIC, flashpoint less than 23°C	P	3	2778
MERCURY BASED PESTICIDE, LIQUID, TOXIC	P	6.1	3012
MERCURY BASED PESTICIDE, LIQUID, TOXIC, FLAMMABLE, flashpoint not less than 23°C	P	6.1	3011
MERCURY BASED PESTICIDE, SOLID, TOXIC	P	6.1	2777
MERCURY BENZOATE	P	6.1	1631
Mercury bichloride, <i>see</i>	P	6.1	1624
Mercury bisulphate, <i>see</i>	P	6.1	1645

Index

Substance, material or article	MP	Class	UN No.
MERCURY BROMIDES	P	6.1	1634
MERCURY COMPOUND, LIQUID, N.O.S.	P	6.1	2024
MERCURY COMPOUND, SOLID, N.O.S.	P	6.1	2025
MERCURY CONTAINED IN MANUFACTURED ARTICLES	-	8	3506
MERCURY CYANIDE	P	6.1	1636
MERCURY FULMINATE, WETTED with not less than 20% water or mixture of alcohol and water, by mass	-	1.1A	0135
MERCURY GLUCONATE	P	6.1	1637
Mercury(II) (mercuric) compounds, see MERCURY BASED PESTICIDE	P	-	-
Mercury(I) (mercurous) compounds, see MERCURY BASED PESTICIDE	P	-	-
MERCURY IODIDE	P	6.1	1638
MERCURY NUCLEATE	P	6.1	1639
MERCURY OLEATE	P	6.1	1640
MERCURY OXIDE	-	6.1	1641
MERCURY OXYCYANIDE, DESENSITIZED	P	6.1	1642
MERCURY OXYCYANIDE pure (transport prohibited)	-	-	-
Mercury potassium cyanide, see	P	6.1	1626
MERCURY POTASSIUM IODIDE	P	6.1	1643
MERCURY SALICYLATE	P	6.1	1644
MERCURY SULPHATE	P	6.1	1645
MERCURY THIOCYANATE	P	6.1	1646
Mesitylene, see	-	3	2325
MESITYL OXIDE	-	3	1229
Mesyl chloride, see	-	6.1	3246
Metaarsenic acid, see	-	6.1	1554
Metacetone, see	-	3	1156
Metal alkyl halides, water-reactive, n.o.s., see	-	4.2	3394
Metal alkyl hydrides, water-reactive, n.o.s., see	-	4.2	3394
Metal alkyls, water-reactive, n.o.s., see	-	4.2	3394
Metal aryl halides, water-reactive, n.o.s., see	-	4.2	3394
Metal aryl hydrides, water-reactive, n.o.s., see	-	4.2	3394
Metal aryls, water-reactive, n.o.s., see	-	4.2	3394
METAL CARBONYLS, LIQUID, N.O.S.	-	6.1	3281
METAL CARBONYLS, SOLID, N.O.S.	-	6.1	3466
METAL CATALYST, DRY	-	4.2	2881
METAL CATALYST, WETTED with a visible excess of liquid	-	4.2	1378
METALDEHYDE	-	4.1	1332
METAL HYDRIDES, FLAMMABLE, N.O.S.	-	4.1	3182
METAL HYDRIDES, WATER-REACTIVE, N.O.S.	-	4.3	1409
METALLIC SUBSTANCE, WATER-REACTIVE, N.O.S.	-	4.3	3208
METALLIC SUBSTANCE, WATER-REACTIVE, SELF-HEATING, N.O.S.	-	4.3	3209
METAL POWDER, FLAMMABLE, N.O.S.	-	4.1	3089
METAL POWDER, SELF-HEATING, N.O.S.	-	4.2	3189

Substance, material or article	MP	Class	UN No.
METAL SALTS OF ORGANIC COMPOUNDS, FLAMMABLE, N.O.S.	–	4.1	3181
Metam-sodium, <i>see</i> THIOCARBAMATE PESTICIDE	P	–	–
Methacraldehyde, stabilized, <i>see</i>	–	3	2396
METHACRYLALDEHYDE, STABILIZED	–	3	2396
3-Methacrylic acid, liquid, <i>see</i>	–	8	3472
3-Methacrylic acid, solid, <i>see</i>	–	8	2823
METHACRYLIC ACID, STABILIZED	–	8	2531
METHACRYLONITRILE, STABILIZED	–	6.1	3079
METHALLYL ALCOHOL	–	3	2614
Methamidophos, <i>see</i> ORGANOPHOSPHORUS PESTICIDE	P	–	–
Methanal, <i>see</i>	–	3	1198
Methanal, <i>see</i>	–	8	2209
Methane and hydrogen, mixtures, compressed, <i>see</i>	–	2.1	2034
METHANE, COMPRESSED	–	2.1	1971
METHANE, REFRIGERATED LIQUID	–	2.1	1972
METHANESULPHONYL CHLORIDE	–	6.1	3246
Methanethiol, <i>see</i>	P	2.3	1064
METHANOL	–	3	1230
Methasulfocarb, <i>see</i> CARBAMATE PESTICIDE	–	–	–
Methidathion, <i>see</i> ORGANOPHOSPHORUS PESTICIDE	P	–	–
Methomyl, <i>see</i> CARBAMATE PESTICIDE	P	–	–
<i>ortho</i> -Methoxyaniline, <i>see</i>	–	6.1	2431
Methoxybenzene, <i>see</i>	–	3	2222
1-Methoxybutane, <i>see</i>	–	3	2350
Methoxyethane, <i>see</i>	–	2.1	1039
2-Methoxyethanol, <i>see</i>	–	3	1188
2-Methoxyethyl acetate, <i>see</i>	–	3	1189
METHOXYMETHYL ISOCYANATE	–	6.1	2605
4-METHOXY-4-METHYLPENTAN-2-ONE	–	3	2293
4-Methoxy-4-methyl-2-pentanone, <i>see</i>	–	3	2293
Methoxynitrobenzenes, liquid, <i>see</i>	–	6.1	2730
Methoxynitrobenzenes, solid, <i>see</i>	–	6.1	3458
1-Methoxypropane, <i>see</i>	–	3	2612
1-METHOXY-2-PROPANOL	–	3	3092
METHYL ACETATE	–	3	1231
Methylacetic acid, <i>see</i>	–	8	1848
METHYLACETYLENE AND PROPADIENE MIXTURE, STABILIZED	–	2.1	1060
<i>beta</i> -Methylacrolein, <i>see</i>	P	6.1	1143
2-Methylacrolein, stabilized	–	3	2396
3-Methylacrolein, stabilized, <i>see</i>	P	6.1	1143
METHYL ACRYLATE, STABILIZED	–	3	1919
METHYLAL	–	3	1234
Methyl alcohol, <i>see</i>	–	3	1230



Index

Substance, material or article	MP	Class	UN No.
Methyl allyl alcohol, <i>see</i>	–	3	2614
Methylallyl alcohol, <i>see</i>	–	3	2614
METHYLALLYL CHLORIDE	–	3	2554
METHYLAMINE, ANHYDROUS	–	2.1	1061
METHYLAMINE, AQUEOUS SOLUTION	–	3	1235
2-( <i>N,N</i> -Methylaminoethylcarbonyl)-4-(3,4-dimethylphenylsulphonyl)benzenediazonium hydrogen sulphate (concentration 96%), <i>see</i>	–	4.1	3236
METHYLAMYL ACETATE	–	3	1233
Methyl amyl alcohol, <i>see</i>	–	3	2053
Methylamyl alcohol, <i>see</i>	–	3	2053
Methyl <i>normal</i> -amyl ketone, <i>see</i>	–	3	1110
<i>N</i> -METHYLANILINE	–	6.1	2294
Methylated spirits, <i>see</i>	–	3	1987
Methylated spirits, <i>see</i>	–	3	1986
Methylbenzene, <i>see</i>	–	3	1294
4-Methylbenzenesulphonylhydrazide (concentration 100%), <i>see</i>	–	4.1	3226
Methylbenzol, <i>see</i>	–	3	1294
<i>alpha</i> -METHYLBENZYL ALCOHOL, LIQUID	–	6.1	2937
<i>alpha</i> -METHYLBENZYL ALCOHOL, SOLID	–	6.1	3438
Methyl borate, <i>see</i>	–	3	2416
Methyl bromide and chloropicrin mixture, <i>see</i>	–	2.3	1581
METHYL BROMIDE AND ETHYLENE DIBROMIDE MIXTURE, LIQUID	P	6.1	1647
METHYL BROMIDE with not more than 2.0% chloropicrin	–	2.3	1062
METHYL BROMOACETATE	–	6.1	2643
2-Methyl-1,3-butadiene, stabilized, <i>see</i>	–	3	1218
2-METHYLBUTANAL	–	3	3371
2-Methylbutane, <i>see</i>	–	3	1265
Methylbutanols, <i>see</i>	–	3	1105
3-METHYLBUTAN-2-ONE	–	3	2397
3-Methyl-2-butanone, <i>see</i>	–	3	2397
2-METHYL-1-BUTENE	–	3	2459
2-METHYL-2-BUTENE	–	3	2460
3-METHYL-1-BUTENE	–	3	2561
2-Methyl butylacrylate, stabilized, <i>see</i>	–	3	2227
<i>N</i> -METHYLBUTYLAMINE	–	3	2945
METHYL <i>tert</i> -BUTYL ETHER	–	3	2398
METHYL BUTYRATE	–	3	1237
Methyl carbonate, <i>see</i>	–	3	1161
METHYL CHLORIDE	–	2.1	1063
Methyl chloride and chloropicrin mixture, <i>see</i>	–	2.3	1582
METHYL CHLORIDE AND METHYLENE CHLORIDE MIXTURE	–	2.1	1912
METHYL CHLOROACETATE	–	6.1	2295
Methylchlorobenzenes, <i>see</i>	–	3	2238

Substance, material or article	MP	Class	UN No.
Methyl chlorocarbonate, <i>see</i>	–	6.1	1238
Methyl chloroform, <i>see</i>	–	6.1	2831
Methylchloroform, <i>see</i>	–	6.1	2831
METHYL CHLOROFORMATE	–	6.1	1238
METHYL CHLOROMETHYL ETHER	–	6.1	1239
METHYL 2-CHLOROPROPIONATE	–	3	2933
<i>alpha</i> -Methyl <i>alpha</i> -chloropropionate, <i>see</i>	–	3	2933
METHYLCHLOROSILANE	–	2.3	2534
Methyl cyanide, <i>see</i>	–	3	1648
METHYLCYCLOHEXANE	–	3	2296
METHYLCYCLOHEXANOLS, flammable	–	3	2617
Methylcyclohexanone peroxide(s) (concentration ≤67%, with diluent Type B), <i>see</i>	–	5.2	3115
METHYLCYCLOHEXANONE	–	3	2297
METHYLCYCLOPENTANE	–	3	2298
METHYL DICHLOROACETATE	–	6.1	2299
METHYLDICHLOROSILANE	–	4.3	1242
Methyldinitrobenzenes, liquid, <i>see</i>	–	6.1	2038
Methyldinitrobenzenes, molten	–	6.1	1600
Methyldinitrobenzenes, solid	–	6.1	3454
Methyl disulphide, <i>see</i>	–	3	2381
Methyldithiomethane, <i>see</i>	–	3	2381
2,2'-Methylenebis-(3,4,6-trichlorophenol), <i>see</i>	–	6.1	2875
Methylene bromide, <i>see</i>	–	6.1	2664
Methylene chloride, <i>see</i>	–	6.1	1593
Methylene chloride and methyl chloride mixture, <i>see</i> METHYL CHLORIDE AND METHYLENE CHLORIDE MIXTURE	–	–	–
Methylene chlorobromide, <i>see</i>	–	6.1	1887
Methylene cyanide, <i>see</i>	–	6.1	2647
<i>p,p'</i> -Methylenedianiline, <i>see</i>	P	6.1	2651
Methylene dibromide, <i>see</i>	–	6.1	2664
Methyl ether, <i>see</i>	–	2.1	1033
Methyl ethyl carbinol, <i>see</i>	–	3	1120
Methyl ethyl ether, <i>see</i>	–	2.1	1039
METHYL ETHYL KETONE	–	3	1193
Methyl ethyl ketone peroxide(s) (concentration ≤40%, with diluent Type A, available oxygen ≤8.2%), <i>see</i>	–	5.2	3107
Methyl ethyl ketone peroxide(s) (concentration ≤45%, with diluent Type A, available oxygen ≤10%), <i>see</i>	–	5.2	3105
Methyl ethyl ketone peroxide(s) (concentration ≤52%, with diluent Type A, available oxygen >10% and ≤10.7%), <i>see</i>	–	5.2	3101
2-METHYL-5-ETHYLPYRIDINE	–	6.1	2300
METHYL FLUORIDE	–	2.1	2454
Methylfluorobenzenes ( <i>ortho</i> -; <i>meta</i> -; <i>para</i> -), <i>see</i>	–	3	2388
METHYL FORMATE	–	3	1243

Index

Substance, material or article	MP	Class	UN No.
2-METHYLFURAN	–	3	2301
Methyl glycol, <i>see</i>	–	3	1188
Methyl glycol acetate, <i>see</i>	–	3	1189
2-Methylheptane, <i>see</i>	–	3	1262
2-METHYL-2-HEPTANETHIOL	–	6.1	3023
5-METHYLHEXAN-2-ONE	–	3	2302
5-Methyl-2-hexanone, <i>see</i>	–	3	2302
METHYLHYDRAZINE	–	6.1	1244
METHYL IODIDE	–	6.1	2644
Methyl isobutenyl ketone, <i>see</i>	–	3	1229
METHYL ISOBUTYL CARBINOL	–	3	2053
Methyl isobutyl carbinol acetate, <i>see</i>	–	3	1233
METHYL ISOBUTYL KETONE	–	3	1245
Methyl isobutyl ketone peroxide(s) (concentration ≤62%, with ≥19% by mass diluent Type A and methyl isobutyl ketone), <i>see</i>	–	5.2	3105
METHYL ISOCYANATE	–	6.1	2480
METHYL ISOPROPENYL KETONE, STABILIZED	–	3	1246
Methyl isopropyl ketone, <i>see</i>	–	3	2397
Methyl isopropyl ketone peroxide(s) (with diluent Type A and active oxygen ≤6.7%)	–	5.2	3109
METHYL ISOTHIOCYANATE	–	6.1	2477
METHYL ISOVALERATE	–	3	2400
METHYLMAGNESIUM BROMIDE IN ETHYL ETHER	–	4.3	1928
METHYL MERCAPTAN	P	2.3	1064
Methyl mercaptopropionaldehyde, <i>see</i>	–	6.1	2785
METHYL METHACRYLATE MONOMER, STABILIZED	–	3	1247
4-METHYLMORPHOLINE	–	3	2535
N-METHYLMORPHOLINE	–	3	2535
METHYL NITRITE (transport prohibited)	–	2.2	2455
Methylnitrophenols, <i>see</i>	–	6.1	2446
METHYL ORTHOSILICATE	–	6.1	2606
METHYLPENTADIENES	–	3	2461
2-Methylpentane, <i>see</i>	–	3	1208
3-Methylpentane, <i>see</i>	–	3	1208
2-METHYLPENTAN-2-OL	–	3	2560
4-Methylpentan-2-ol, <i>see</i>	–	3	2053
4-Methyl-2-pentanone, <i>see</i>	–	3	1245
4-Methyl-3-penten-2-one, <i>see</i>	–	3	1229
3-Methyl-2-penten-4-yn-ol, <i>see</i>	–	8	2705
METHYLPHENYLDICHLOROSILANE	–	8	2437
Methyl phenyl ether, <i>see</i>	–	3	2222
2-Methyl-2-phenylpropane, <i>see</i>	–	3	2709
1-METHYLPYPERIDINE	–	3	2399
N-Methylpiperidine, <i>see</i>	–	3	2399

Substance, material or article	MP	Class	UN No.
2-Methylpropanol-1, <i>see</i>	–	3	1212
2-Methyl-2-propanol	–	3	1120
2-Methylpropanoyl chloride, <i>see</i>	–	3	2395
2-Methyl-2-propen-1-ol, <i>see</i>	–	3	2614
METHYL PROPIONATE	–	3	1248
2-Methylpropionic acid, <i>see</i>	–	3	2529
Methylpropyl acrylate, stabilized, <i>see</i>	–	3	2527
Methylpropylbenzenes, <i>see</i>	P	3	2046
METHYL PROPYL ETHER	–	3	2612
2-Methylpropyl isobutyrate, <i>see</i>	–	3	2528
METHYL PROPYL KETONE	–	3	1249
Methylpyridines (2-; 3-; 4-), <i>see</i>	–	3	2313
3-Methyl-4-(pyrrolidin-1-yl)benzenediazonium tetrafluoroborate (concentration 95%), <i>see</i>	–	4.1	3234
<i>alpha</i> -Methylstyrene, <i>see</i>	–	3	2303
Methylstyrenes, stabilized, <i>see</i>	–	3	2618
Methyl sulphate, <i>see</i>	–	6.1	1595
Methyl sulphide, <i>see</i>	–	3	1164
METHYLTETRAHYDROFURAN	–	3	2536
METHYL TRICHLOROACETATE	–	6.1	2533
METHYLTRICHLOROSILANE	–	3	1250
Methyltrithion, <i>see</i> ORGANOPHOSPHORUS PESTICIDE	P	–	–
<i>alpha</i> -METHYLVALERALDEHYDE	–	3	2367
1-Methylvinyl acetate, <i>see</i>	–	3	2403
Methylvinylbenzenes, stabilized, <i>see</i>	–	3	2618
METHYL VINYL KETONE, STABILIZED	–	6.1	1251
Mevinphos, <i>see</i> ORGANOPHOSPHORUS PESTICIDE	P	–	–
Mexacarbate, <i>see</i> CARBAMATE PESTICIDE	P	–	–
M.I.B.C., <i>see</i>	–	3	2053
MINES with bursting charge	–	1.1D	0137
MINES with bursting charge	–	1.1F	0136
MINES with bursting charge	–	1.2D	0138
MINES with bursting charge	–	1.2F	0294
Mirex, <i>see</i> ORGANOCHLORINE PESTICIDE	P	–	–
Mischmetall, <i>see</i>	–	4.1	1333
Missiles, guided, <i>see</i> ROCKETS	–	–	–
Mixed acid, <i>see</i>	–	8	1796
Mixed acid, spent, <i>see</i>	–	8	1826
Mixtures of an inorganic nitrite with an ammonium salt (transport prohibited)	–	–	–
Mobam, <i>see</i> CARBAMATE PESTICIDE	–	–	–
MOLYBDENUM PENTACHLORIDE	–	8	2508
Monobromobenzene, <i>see</i>	P	3	2514
Monochloroacetic acid, molten, <i>see</i>	–	6.1	3250

Index

Substance, material or article	MP	Class	UN No.
Monochloroacetic acid, solid, <i>see</i>	–	6.1	1751
Monochloroacetic acid solution, <i>see</i>	–	6.1	1750
Monochloroacetone, stabilized, <i>see</i>	P	6.1	1695
Monochlorobenzene, <i>see</i>	–	3	1134
Monochlorobenzol, <i>see</i>	–	3	1134
Monochlorodifluoromethane, <i>see</i>	–	2.2	1018
Monochlorodifluoromethane and monochloropentafluoroethane mixture with a fixed boiling point containing about 49% monochlorodifluoromethane, <i>see</i>	–	2.2	1973
Monochlorodifluoromonobromomethane, <i>see</i>	–	2.2	1974
Monochloropentafluoroethane, <i>see</i>	–	2.2	1020
Monochlorotetrafluoroethane, <i>see</i>	–	2.2	1021
Monochlorotrifluoromethane, <i>see</i>	–	2.2	1022
Monocrotophos, <i>see</i> ORGANOPHOSPHORUS PESTICIDE	P	–	–
Monoethanolamine, <i>see</i>	–	8	2491
Monoethylamine, <i>see</i>	–	2.1	1036
Monoethylamine, aqueous solution, <i>see</i>	–	3	2270
Monomethylamine, anhydrous, <i>see</i>	–	2.1	1061
Monomethylamine, aqueous solution, <i>see</i>	–	3	1235
Monomethylaniline, <i>see</i>	–	6.1	2294
MONONITROTOLUIDINES	–	6.1	2660
Monopropylamine, <i>see</i>	–	3	1277
MORPHOLINE	–	8	2054
MOTOR FUEL ANTI-KNOCK MIXTURE	P	6.1	1649
MOTOR FUEL ANTI-KNOCK MIXTURE, FLAMMABLE	P	6.1	3483
MOTOR SPIRIT	–	3	1203
Muriatic acid, <i>see</i>	–	8	1789
Muritan, <i>see</i> CARBAMATE PESTICIDE	–	–	–
MUSK XYLENE	–	4.1	2956
Mysorite, <i>see</i>	–	9	2212
Nabam, <i>see</i> THIOCARBAMATE PESTICIDE	P	–	–
Naled, <i>see</i> ORGANOPHOSPHORUS PESTICIDE	P	–	–
Naphtha, <i>see</i>	–	3	1268
NAPHTHALENE, CRUDE	–	4.1	1334
NAPHTHALENE, MOLTEN	–	4.1	2304
NAPHTHALENE, REFINED	–	4.1	1334
Naphtha, petroleum, <i>see</i>	–	3	1268
Naphtha, solvent, <i>see</i>	–	3	1268
<i>alpha</i> -NAPHTHYLAMINE	–	6.1	2077
<i>beta</i> -NAPHTHYLAMINE, SOLID	–	6.1	1650
<i>beta</i> -NAPHTHYLAMINE SOLUTION	–	6.1	3411
NAPHTHYLTHIOUREA	–	6.1	1651
1-Naphthylthiourea, <i>see</i>	–	6.1	1651

Substance, material or article	MP	Class	UN No.
<i>alpha</i> -Naphthylthiourea, <i>see</i>	–	6.1	1651
NAPHTHYLUREA	–	6.1	1652
NATURAL GAS, COMPRESSED with high methane content	–	2.1	1971
Natural gasoline, <i>see</i> MOTOR SPIRIT or GASOLINE or PETROL	–	–	–
NATURAL GAS, REFRIGERATED LIQUID with high methane content	–	2.1	1972
Neodymium nitrate and praseodymium nitrate mixture, <i>see</i>	–	5.1	1456
Neohexane, <i>see</i>	–	3	1208
NEON, COMPRESSED	–	2.2	1065
NEON, REFRIGERATED LIQUID	–	2.2	1913
Neopentane, <i>see</i>	–	2.1	2044
Neothyl, <i>see</i>	–	3	2612
NICKEL CARBONYL	P	6.1	1259
NICKEL CYANIDE	P	6.1	1653
Nickel(II) cyanide, <i>see</i>	P	6.1	1653
NICKEL NITRATE	–	5.1	2725
Nickel(II) nitrate, <i>see</i>	–	5.1	2725
NICKEL NITRITE	–	5.1	2726
Nickel(II) nitrite, <i>see</i>	–	5.1	2726
Nickelous nitrate, <i>see</i>	–	5.1	2725
Nickelous nitrite, <i>see</i>	–	5.1	2726
Nickel tetracarbonyl, <i>see</i>	P	6.1	1259
NICOTINE	–	6.1	1654
NICOTINE COMPOUND, LIQUID, N.O.S.	–	6.1	3144
NICOTINE COMPOUND, SOLID, N.O.S.	–	6.1	1655
NICOTINE HYDROCHLORIDE, LIQUID	–	6.1	1656
NICOTINE HYDROCHLORIDE, SOLID	–	6.1	3444
NICOTINE HYDROCHLORIDE SOLUTION	–	6.1	1656
NICOTINE PREPARATION, LIQUID, N.O.S.	–	6.1	3144
NICOTINE PREPARATION, SOLID, N.O.S.	–	6.1	1655
NICOTINE SALICYLATE	–	6.1	1657
NICOTINE SULPHATE, SOLID	–	6.1	3445
NICOTINE SULPHATE SOLUTION	–	6.1	1658
NICOTINE TARTRATE	–	6.1	1659
NITRATES, INORGANIC, AQUEOUS SOLUTION, N.O.S.	–	5.1	3218
NITRATES, INORGANIC, N.O.S.	–	5.1	1477
NITRATING ACID MIXTURE, SPENT with more than 50% nitric acid	–	8	1826
NITRATING ACID MIXTURE, SPENT with not more than 50% nitric acid	–	8	1826
NITRATING ACID MIXTURE with more than 50% nitric acid	–	8	1796
NITRATING ACID MIXTURE with not more than 50% nitric acid	–	8	1796
NITRIC ACID other than red fuming, with at least 65% but with not more than 70% nitric acid	–	8	2031
NITRIC ACID other than red fuming, with less than 65% nitric acid	–	8	2031
NITRIC ACID other than red fuming, with more than 70% nitric acid	–	8	2031

Index

Substance, material or article	MP	Class	UN No.
NITRIC ACID, RED FUMING	–	8	2032
NITRIC OXIDE AND DINITROGEN TETROXIDE MIXTURE	–	2.3	1975
NITRIC OXIDE AND NITROGEN DIOXIDE MIXTURE	–	2.3	1975
NITRIC OXIDE, COMPRESSED	–	2.3	1660
NITRILES, FLAMMABLE, TOXIC, N.O.S.	–	3	3273
NITRILES, TOXIC, FLAMMABLE, N.O.S.	–	6.1	3275
NITRILES, LIQUID TOXIC, N.O.S.	–	6.1	3276
NITRILES, SOLID, TOXIC, N.O.S.	–	6.1	3439
NITRITES, INORGANIC, AQUEOUS SOLUTION, N.O.S.	–	5.1	3219
Nitrites, inorganic, mixtures with ammonium compounds (transport prohibited)	–	–	–
NITRITES, INORGANIC, N.O.S.	–	5.1	2627
NITROANILINES ( <i>o</i> -, <i>m</i> -, <i>p</i> -)	–	6.1	1661
NITROANISOLES, LIQUID	–	6.1	2730
NITROANISOLES, SOLID	–	6.1	3458
NITROBENZENE	–	6.1	1662
Nitrobenzene bromides, liquid, see	–	6.1	2732
Nitrobenzene bromides, solid, see	–	6.1	3459
NITROBENZENESULPHONIC ACID	–	8	2305
Nitrobenzol, see	–	6.1	1662
5-NITROBENZOTRIAZOL	–	1.1D	0385
NITROBENZOTRIFLUORIDES, LIQUID	P	6.1	2306
NITROBENZOTRIFLUORIDES, SOLID	P	6.1	3431
NITROBROMOBENZENES, LIQUID	–	6.1	2732
NITROBROMOBENZENES, SOLID	–	6.1	3459
Nitrocarbonitrates, see EXPLOSIVE, BLASTING, TYPE B	–	–	–
NITROCELLULOSE dry or wetted with less than 25% water (or alcohol), by mass	–	1.1D	0340
NITROCELLULOSE MEMBRANE FILTERS with not more than 12.6% nitrogen, by dry mass	–	4.1	3270
NITROCELLULOSE, PLASTICIZED with not less than 18% plasticizing substance, by mass	–	1.3C	0343
NITROCELLULOSE SOLUTION, FLAMMABLE with not more than 12.6% nitrogen, by dry mass, and not more than 55% nitrocellulose	–	3	2059
NITROCELLULOSE unmodified or plasticized with less than 18% plasticizing substance, by mass	–	1.1D	0341
NITROCELLULOSE, WETTED with not less than 25% alcohol, by mass	–	1.3C	0342
NITROCELLULOSE WITH ALCOHOL (not less than 25% alcohol, by mass, and not more than 12.6% nitrogen, by dry mass)	–	4.1	2556
NITROCELLULOSE with not more than 12.6% nitrogen, by dry mass, MIXTURE WITHOUT PLASTICIZER, WITHOUT PIGMENT	–	4.1	2557
NITROCELLULOSE with not more than 12.6% nitrogen, by dry mass, MIXTURE WITHOUT PLASTICIZER, WITH PIGMENT	–	4.1	2557
NITROCELLULOSE with not more than 12.6% nitrogen, by dry mass, MIXTURE WITH PLASTICIZER, WITHOUT PIGMENT	–	4.1	2557
NITROCELLULOSE with not more than 12.6% nitrogen, by dry mass, MIXTURE WITH PLASTICIZER, WITH PIGMENT	–	4.1	2557

Substance, material or article	MP	Class	UN No.
NITROCELLULOSE WITH WATER (not less than 25% water, by mass)	–	4.1	2555
Nitrochlorobenzenes, <i>see</i>	–	6.1	1578
3-NITRO-4-CHLOROBENZOTRIFLUORIDE	P	6.1	2307
Nitrocotton solution, <i>see</i>	–	3	2059
Nitrocotton with alcohol, <i>see</i>	–	4.1	2556
Nitrocotton with plasticizing substance, <i>see</i>	–	4.1	2557
Nitrocotton with water, <i>see</i>	–	4.1	2555
NITROCRESOLS, LIQUID	–	6.1	3434
NITROCRESOLS, SOLID	–	6.1	2446
NITROETHANE	–	3	2842
NITROGEN, COMPRESSED	–	2.2	1066
NITROGEN DIOXIDE	–	2.3	1067
Nitrogen dioxide and nitric oxide mixtures, <i>see</i>	–	2.3	1975
Nitrogen peroxide, <i>see</i>	–	2.3	1067
NITROGEN, REFRIGERATED LIQUID	–	2.2	1977
Nitrogen sesquioxide, <i>see</i>	–	2.3	2421
NITROGEN TRIFLUORIDE	–	2.2	2451
NITROGEN TRIOXIDE	–	2.3	2421
NITROGLYCERIN, DESENSITIZED with not less than 40% non-volatile water-insoluble phlegmatizer, by mass	–	1.1D	0143
NITROGLYCERIN MIXTURE, DESENSITIZED, LIQUID, FLAMMABLE, N.O.S. with not more than 30% nitroglycerin, by mass	–	3	3343
NITROGLYCERIN MIXTURE, DESENSITIZED, LIQUID, N.O.S. with not more than 30% nitroglycerin, by mass	–	3	3357
NITROGLYCERIN MIXTURE, DESENSITIZED, SOLID, N.O.S. with more than 2% but not more than 10% nitroglycerin, by mass	–	4.1	3319
NITROGLYCERIN SOLUTION IN ALCOHOL with more than 1% but not more than 5% nitroglycerin	–	3	3064
NITROGLYCERIN SOLUTION IN ALCOHOL with more than 1% but not more than 10% nitroglycerin	–	1.1D	0144
NITROGLYCERIN SOLUTION IN ALCOHOL with not more than 1% nitroglycerin	–	3	1204
NITROGUANIDINE dry or wetted with less than 20% water, by mass	–	1.1D	0282
NITROGUANIDINE, WETTED with not less than 20% water, by mass	–	4.1	1336
NITROHYDROCHLORIC ACID	–	8	1798
NITROMANNITE, WETTED with not less than 40% water, or mixture of alcohol and water, by mass	–	1.1D	0133
NITROMETHANE	–	3	1261
Nitromuriatic acid, <i>see</i>	–	8	1798
NITRONAPHTHALENE	–	4.1	2538
NITROPHENOLS ( <i>o</i> -, <i>m</i> -, <i>p</i> -)	–	6.1	1663
4-NITROPHENYLHYDRAZINE with not less than 30% water, by mass	–	4.1	3376
NITROPROPANES	–	3	2608
<i>p</i> -NITROSODIMETHYLANILINE	–	4.2	1369
4-Nitrosophenol (concentration 100%), <i>see</i>	–	4.1	3236
NITROSTARCH dry or wetted, with less than 20% water, by mass	–	1.1D	0146



Index

Substance, material or article	MP	Class	UN No.
NITROSTARCH, WETTED with not less than 20% water, by mass	–	4.1	1337
NITROSYL CHLORIDE	–	2.3	1069
NITROSYLSULPHURIC ACID, LIQUID	–	8	2308
NITROSYLSULPHURIC ACID, SOLID	–	8	3456
NITROTOLUENES, LIQUID	–	6.1	1664
NITROTOLUENES, SOLID	–	6.1	3446
NITROTOLUIDINES (MONO)	–	6.1	2660
NITROTRIAZOLONE	–	1.1D	0490
Nitrotrichloromethane, <i>see</i>	–	6.1	1580
NITRO UREA	–	1.1D	0147
Nitrous ether solution, <i>see</i>	–	3	1194
NITROUS OXIDE	–	2.2	1070
NITROUS OXIDE, REFRIGERATED LIQUID	–	2.2	2201
NITROXYLENES, LIQUID	–	6.1	1665
NITROXYLENES, SOLID	–	6.1	3447
Non-activated carbon, <i>see</i>	–	4.2	1361
Non-activated charcoal, <i>see</i>	–	4.2	1361
NONANES	–	3	1920
Nonylphenol, <i>see</i>	P	8	3145
NONYLTRICHLOROSILANE	–	8	1799
Norbormide, <i>see</i> PESTICIDE, N.O.S.	–	–	–
2,5-NORBORNADIENE, STABILIZED	–	3	2251
NTO	–	1.1D	0490
OCTADECYLTRICHLOROSILANE	–	8	1800
OCTADIENE	–	3	2309
OCTAFLUOROBUT-2-ENE	–	2.2	2422
Octafluoro-2-butene, <i>see</i>	–	2.2	2422
OCTAFLUOROCYCLOBUTANE	–	2.2	1976
OCTAFLUOROPROPANE	–	2.2	2424
Octaldehyde, <i>see</i>	–	3	1191
OCTANES	–	3	1262
3-Octanone, <i>see</i>	–	3	2271
OCTOGEN, DESENSITIZED	–	1.1D	0484
OCTOGEN, WETTED with not less than 15% water, by mass	–	1.1D	0226
OCTOL dry or wetted with less than 15% water, by mass	–	1.1D	0266
OCTOLITE dry or wetted with less than 15% water, by mass	–	1.1D	0266
OCTONAL	–	1.1D	0496
OCTYL ALDEHYDES	–	3	1191
<i>tert</i> -Octyl mercaptan, <i>see</i>	–	6.1	3023
OCTYLTRICHLOROSILANE	–	8	1801
Oenanthal, <i>see</i>	–	3	3056
Oil cake, <i>see</i>	–	4.2	1386

Substance, material or article	MP	Class	UN No.
OIL GAS, COMPRESSED	–	2.3	1071
Oleum, <i>see</i>	–	8	1831
Oleylamine, <i>see Note 1</i>	P	–	–
Omethoate, <i>see</i> ORGANOPHOSPHORUS PESTICIDE	–	–	–
Organic peroxide, liquid, sample, <i>see</i>	–	5.2	3103
Organic peroxide, liquid, sample, temperature controlled, <i>see</i>	–	5.2	3113
Organic peroxide, solid, sample, <i>see</i>	–	5.2	3104
Organic peroxide, solid, sample, temperature controlled, <i>see</i>	–	5.2	3114
ORGANIC PEROXIDE TYPE B, LIQUID	–	5.2	3101
ORGANIC PEROXIDE TYPE B, LIQUID, TEMPERATURE CONTROLLED	–	5.2	3111
ORGANIC PEROXIDE TYPE B, SOLID	–	5.2	3102
ORGANIC PEROXIDE TYPE B, SOLID, TEMPERATURE CONTROLLED	–	5.2	3112
ORGANIC PEROXIDE TYPE C, LIQUID	–	5.2	3103
ORGANIC PEROXIDE TYPE C, LIQUID, TEMPERATURE CONTROLLED	–	5.2	3113
ORGANIC PEROXIDE TYPE C, SOLID	–	5.2	3104
ORGANIC PEROXIDE TYPE C, SOLID, TEMPERATURE CONTROLLED	–	5.2	3114
ORGANIC PEROXIDE TYPE D, LIQUID	–	5.2	3105
ORGANIC PEROXIDE TYPE D, LIQUID, TEMPERATURE CONTROLLED	–	5.2	3115
ORGANIC PEROXIDE TYPE D, SOLID	–	5.2	3106
ORGANIC PEROXIDE TYPE D, SOLID, TEMPERATURE CONTROLLED	–	5.2	3116
ORGANIC PEROXIDE TYPE E, LIQUID	–	5.2	3107
ORGANIC PEROXIDE TYPE E, LIQUID, TEMPERATURE CONTROLLED	–	5.2	3117
ORGANIC PEROXIDE TYPE E, SOLID	–	5.2	3108
ORGANIC PEROXIDE TYPE E, SOLID, TEMPERATURE CONTROLLED	–	5.2	3118
ORGANIC PEROXIDE TYPE F, LIQUID	–	5.2	3109
ORGANIC PEROXIDE TYPE F, LIQUID, TEMPERATURE CONTROLLED	–	5.2	3119
ORGANIC PEROXIDE TYPE F, SOLID	–	5.2	3110
ORGANIC PEROXIDE TYPE F, SOLID, TEMPERATURE CONTROLLED	–	5.2	3120
ORGANIC PIGMENTS, SELF-HEATING	–	4.2	3313
ORGANOARSENIC COMPOUND, LIQUID, N.O.S.	–	6.1	3280
ORGANOARSENIC COMPOUND, SOLID, N.O.S.	–	6.1	3465
ORGANOCHLORINE PESTICIDE, LIQUID, FLAMMABLE, TOXIC, flashpoint less than 23°C	–	3	2762
ORGANOCHLORINE PESTICIDE, LIQUID, TOXIC	–	6.1	2996
ORGANOCHLORINE PESTICIDE, LIQUID, TOXIC, FLAMMABLE, flashpoint not less than 23°C	–	6.1	2995
ORGANOCHLORINE PESTICIDE, SOLID, TOXIC	–	6.1	2761
Organometallic compound dispersion, water-reactive, flammable, <i>see</i>	–	4.3	3399
Organometallic compound solid, water-reactive, flammable, <i>see</i>	–	4.3	3396
Organometallic compound solution, water-reactive, flammable, <i>see</i>	–	4.3	3399
ORGANOMETALLIC COMPOUND, LIQUID, TOXIC, N.O.S.	–	6.1	3282
ORGANOMETALLIC COMPOUND, SOLID, TOXIC, N.O.S.	–	6.1	3467
ORGANOMETALLIC SUBSTANCE, LIQUID, PYROPHORIC	–	4.2	3392

Index

Substance, material or article	MP	Class	UN No.
ORGANOMETALLIC SUBSTANCE, LIQUID, PYROPHORIC, WATER-REACTIVE	–	4.2	3394
ORGANOMETALLIC SUBSTANCE, LIQUID, WATER-REACTIVE	–	4.3	3398
ORGANOMETALLIC SUBSTANCE, LIQUID, WATER-REACTIVE, FLAMMABLE	–	4.3	3399
ORGANOMETALLIC SUBSTANCE, SOLID, PYROPHORIC	–	4.2	3391
ORGANOMETALLIC SUBSTANCE, SOLID, PYROPHORIC, WATER-REACTIVE	–	4.2	3393
ORGANOMETALLIC SUBSTANCE, SOLID, SELF-HEATING	–	4.2	3400
ORGANOMETALLIC SUBSTANCE, SOLID, WATER-REACTIVE	–	4.3	3395
ORGANOMETALLIC SUBSTANCE, SOLID, WATER-REACTIVE, FLAMMABLE	–	4.3	3396
ORGANOMETALLIC SUBSTANCE, SOLID, WATER-REACTIVE, SELF-HEATING	–	4.3	3397
ORGANOPHOSPHORUS COMPOUND, TOXIC, FLAMMABLE, N.O.S.	–	6.1	3279
ORGANOPHOSPHORUS COMPOUND, LIQUID, TOXIC, N.O.S.	–	6.1	3278
ORGANOPHOSPHORUS COMPOUND, SOLID, TOXIC, N.O.S.	–	6.1	3464
ORGANOPHOSPHORUS PESTICIDE, LIQUID, FLAMMABLE, TOXIC, flashpoint less than 23°C	–	3	2784
ORGANOPHOSPHORUS PESTICIDE, LIQUID, TOXIC	–	6.1	3018
ORGANOPHOSPHORUS PESTICIDE, LIQUID, TOXIC, FLAMMABLE, flashpoint not less than 23°C	–	6.1	3017
ORGANOPHOSPHORUS PESTICIDE, SOLID, TOXIC	–	6.1	2783
ORGANOTIN COMPOUND, LIQUID, N.O.S.	P	6.1	2788
ORGANOTIN COMPOUND, SOLID, N.O.S.	P	6.1	3146
Organotin compounds (pesticides), <i>see</i> ORGANOTIN PESTICIDE	P	–	–
ORGANOTIN PESTICIDE, LIQUID, FLAMMABLE, TOXIC, flashpoint less than 23°C	P	3	2787
ORGANOTIN PESTICIDE, LIQUID, TOXIC	P	6.1	3020
ORGANOTIN PESTICIDE, LIQUID, TOXIC, FLAMMABLE, flashpoint not less than 23°C	P	6.1	3019
ORGANOTIN PESTICIDE, SOLID, TOXIC	P	6.1	2786
Orthoarsenic acid, <i>see</i>	–	6.1	1553
Orthophosphoric acid, liquid, <i>see</i>	–	8	1805
Orthophosphoric acid, solid, <i>see</i>	–	8	3453
OSMIUM TETROXIDE	P	6.1	2471
Oxamyl, <i>see</i> PESTICIDE, N.O.S.	P	–	–
OXIDIZING LIQUID, CORROSIVE, N.O.S.	–	5.1	3098
OXIDIZING LIQUID, N.O.S.	–	5.1	3139
OXIDIZING LIQUID, TOXIC, N.O.S.	–	5.1	3099
OXIDIZING SOLID, CORROSIVE, N.O.S.	–	5.1	3085
OXIDIZING SOLID, FLAMMABLE, N.O.S.	–	5.1	3137
OXIDIZING SOLID, N.O.S.	–	5.1	1479
OXIDIZING SOLID, SELF-HEATING, N.O.S.	–	5.1	3100
OXIDIZING SOLID, TOXIC, N.O.S.	–	5.1	3087
OXIDIZING SOLID, WATER-REACTIVE, N.O.S.	–	5.1	3121

Substance, material or article	MP	Class	UN No.
Oxirane, <i>see</i>	–	2.3	1040
Oxirane with nitrogen up to a total pressure of 1 MPa (10 bar) at 50°C	–	2.3	1040
Oxydemeton-methyl, <i>see</i> ORGANOPHOSPHORUS PESTICIDE	–	–	–
Oxydisulfoton, <i>see</i> ORGANOPHOSPHORUS PESTICIDE	P	–	–
OXYGEN, COMPRESSED	–	2.2	1072
OXYGEN DIFLUORIDE, COMPRESSED	–	2.3	2190
Oxygen fluoride, compressed, <i>see</i>	–	2.3	2190
OXYGEN GENERATOR, CHEMICAL	–	5.1	3356
OXYGEN, REFRIGERATED LIQUID	–	2.2	1073
1-Oxy-4-nitrobenzene, <i>see</i>	–	6.1	1662
PAINT (including paint, lacquer, enamel, stain, shellac, varnish, polish, liquid filler and liquid lacquer base)	–	3	1263
PAINT (including paint, lacquer, enamel, stain, shellac, varnish, polish, liquid filler and liquid lacquer base)	–	8	3066
PAINT, CORROSIVE, FLAMMABLE (including paint, lacquer, enamel, stain, shellac, varnish, polish, liquid filler and liquid lacquer base)	–	8	3470
PAINT, FLAMMABLE, CORROSIVE (including paint, lacquer, enamel, stain, shellac, varnish, polish, liquid filler and liquid lacquer base)	–	3	3469
PAINT RELATED MATERIAL (including paint thinning or reducing compound)	–	3	1263
PAINT RELATED MATERIAL (including paint thinning or reducing compound)	–	8	3066
PAPER, UNSATURATED OIL TREATED incompletely dried (including carbon paper)	–	4.2	1379
Para-acetaldehyde, <i>see</i>	–	3	1264
PARAFORMALDEHYDE	–	4.1	2213
PARALDEHYDE	–	3	1264
Paraoxon, <i>see</i> ORGANOPHOSPHORUS PESTICIDE	P	–	–
Paraquat, <i>see</i> BIPYRIDILIUM PESTICIDE	–	–	–
Parathion, <i>see</i> ORGANOPHOSPHORUS PESTICIDE	P	–	–
Parathion-methyl, <i>see</i> ORGANOPHOSPHORUS PESTICIDE	P	–	–
PCBs, liquid, <i>see</i>	P	9	2315
PCBs, solid, <i>see</i>	P	9	3432
PENTABORANE	–	4.2	1380
PENTACHLOROETHANE	P	6.1	1669
PENTACHLOROPHENOL	P	6.1	3155
Pentachlorophenol, <i>see</i> ORGANOCHLORINE PESTICIDE	P	–	–
PENTAERYTHRITETETRANITRATE, DESENSITIZED with not less than 15% phlegmatizer, by mass	–	1.1D	0150
PENTAERYTHRITETETRANITRATE MIXTURE, DESENSITIZED, SOLID, N.O.S. with more than 10% but not more than 20% PETN, by mass	–	4.1	3344
PENTAERYTHRITETETRANITRATE, WETTED with not less than 25% water, by mass	–	1.1D	0150
PENTAERYTHRITETETRANITRATE with not less than 7% wax, by mass	–	1.1D	0411

Index

Substance, material or article	MP	Class	UN No.
PENTAERYTHRITOL TETRANITRATE, DESENSITIZED with not less than 15% phlegmatizer, by mass	–	1.1D	0150
PENTAERYTHRITOL TETRANITRATE MIXTURE, DESENSITIZED, SOLID, N.O.S. with more than 10% but not more than 20% PETN, by mass	–	4.1	3344
PENTAERYTHRITOL TETRANITRATE, WETTED with not less than 25% water, by mass	–	1.1D	0150
PENTAERYTHRITOL TETRANITRATE with not less than 7% wax, by mass	–	1.1D	0411
PENTAFLUOROETHANE	–	2.2	3220
Pentafluoroethoxytrifluoroethylene, see	–	2.1	3154
Pentafluoroethyl trifluorovinyl ether, see	–	2.1	3154
Pentalin, see	P	6.1	1669
Pentamethylene, see	–	3	1146
PENTAMETHYLHEPTANE	–	3	2286
3,3,5,7,7-Pentamethyl-1,2,4-trioxepane (concentration ≤100%)	–	5.2	3107
Pentanals, see	–	3	2058
Pentane, see	–	3	1265
PENTANE-2,4-DIONE	–	3	2310
2,4-Pentanedione, see	–	3	2310
PENTANES, LIQUID	–	3	1265
Pentanethiols, see	–	3	1111
PENTANOLS	–	3	1105
2-Pentanone, see	–	3	1249
3-Pentanone, see	–	3	1156
1-PENTENE	–	3	1108
1-PENTOL	–	8	2705
PENTOLITE dry or wetted with less than 15% water, by mass	–	1.1D	0151
Pentylamines, see	–	3	1106
<i>n</i> -Pentylbenzene, see Note 1	P	–	–
Pentyl butanoates, see	–	3	2620
Pentyl butyrates, see	–	3	2620
Pentyl formates, see	–	3	1109
Pentyl nitrates, see	–	3	1112
Pentyl nitrite, see	–	3	1113
PERCHLORATES, INORGANIC, AQUEOUS SOLUTION, N.O.S.	–	5.1	3211
PERCHLORATES, INORGANIC, N.O.S.	–	5.1	1481
PERCHLORIC ACID with more than 50% but not more than 72% acid, by mass	–	5.1	1873
PERCHLORIC ACID, with more than 72% acid by mass (transport prohibited)	–	–	–
PERCHLORIC ACID with not more than 50% acid, by mass	–	8	1802
Perchlorobenzene, see	–	6.1	2729
Perchlorocyclopentadiene, see	–	6.1	2646
Perchloroethylene, see	P	6.1	1897

Substance, material or article	MP	Class	UN No.
PERCHLOROMETHYL MERCAPTAN	P	6.1	1670
PERCHLORYL FLUORIDE	–	2.3	3083
Perfluoroacetyl chloride, <i>see</i>	–	2.3	3057
Perfluoro-2-butene, <i>see</i>	–	2.2	2422
PERFLUORO(ETHYL VINYL ETHER)	–	2.1	3154
PERFLUORO(METHYL VINYL ETHER)	–	2.1	3153
Perfluoropropane, <i>see</i>	–	2.2	2424
PERFUMERY PRODUCTS with flammable liquid	–	3	1266
PERMANGANATES, INORGANIC, AQUEOUS SOLUTION, N.O.S.	–	5.1	3214
PERMANGANATES, INORGANIC, N.O.S.	–	5.1	1482
PEROXIDES, INORGANIC, N.O.S.	–	5.1	1483
Peroxyacetic acid and hydrogen peroxide mixture, <i>see</i>	–	5.1	3149
Peroxyacetic acid, Type D (concentration $\leq 43\%$ ), stabilized, <i>see</i>	–	5.2	3105
Peroxyacetic acid, Type E (concentration $\leq 43\%$ ), stabilized, <i>see</i>	–	5.2	3107
Peroxyacetic acid, Type F (concentration $\leq 43\%$ ), stabilized, <i>see</i>	–	5.2	3109
Peroxyauric acid (concentration $\leq 100\%$ ), <i>see</i>	–	5.2	3118
PERSULPHATES, INORGANIC, AQUEOUS SOLUTION, N.O.S.	–	5.1	3216
PERSULPHATES, INORGANIC, N.O.S.	–	5.1	3215
PESTICIDE, LIQUID, FLAMMABLE, TOXIC, N.O.S. flashpoint less than 23°C	–	3	3021
PESTICIDE, LIQUID, TOXIC, FLAMMABLE, N.O.S. flashpoint not less than 23°C	–	6.1	2903
PESTICIDE, LIQUID, TOXIC, N.O.S.	–	6.1	2902
PESTICIDE, SOLID, TOXIC, N.O.S.	–	6.1	2588
PETN, DESENSITIZED with not less than 15% phlegmatizer, by mass	–	1.1D	0150
PETN MIXTURE, DESENSITIZED, SOLID, N.O.S. with more than 10% but not more than 20% PETN, by mass	–	4.1	3344
PETN/TNT, <i>see</i>	–	1.1D	0151
PETN, WETTED with not less than 25% water, by mass	–	1.1D	0150
PETN with not less than 7% wax, by mass	–	1.1D	0411
PETROL	–	3	1203
PETROLEUM CRUDE OIL	–	3	1267
PETROLEUM DISTILLATES, N.O.S.	–	3	1268
Petroleum ether, <i>see</i>	–	3	1268
PETROLEUM GASES, LIQUEFIED	–	2.1	1075
Petroleum naphtha, <i>see</i>	–	3	1268
Petroleum oil, <i>see</i>	–	3	1268
PETROLEUM PRODUCTS, N.O.S.	–	3	1268
Petroleum raffinate, <i>see</i>	–	3	1268
PETROLEUM SOUR CRUDE OIL, FLAMMABLE, TOXIC	–	3	3494
Petroleum spirit, <i>see</i> PETROLEUM DISTILLATES, N.O.S. or PETROLEUM PRODUCTS, N.O.S.	–	–	–
PHENACYL BROMIDE	–	6.1	2645
Phenarsazine chloride, <i>see</i>	P	6.1	1698

Index

Substance, material or article	MP	Class	UN No.
PHENETIDINES	–	6.1	2311
Phenkapton, <i>see</i> ORGANOPHOSPHORUS PESTICIDE	–	–	–
PHENOLATES, LIQUID	–	8	2904
PHENOLATES, SOLID	–	8	2905
PHENOL, MOLTEN	–	6.1	2312
PHENOL, SOLID	–	6.1	1671
PHENOL SOLUTION	–	6.1	2821
PHENOLSULPHONIC ACID, LIQUID	–	8	1803
<i>d</i> -Phenothrin, <i>see</i> Note 1	P	–	–
PHENOXYACETIC ACID DERIVATIVE PESTICIDE, LIQUID, FLAMMABLE, TOXIC flashpoint less than 23°C	–	3	3346
PHENOXYACETIC ACID DERIVATIVE PESTICIDE, LIQUID, TOXIC	–	6.1	3348
PHENOXYACETIC ACID DERIVATIVE PESTICIDE, LIQUID, TOXIC, FLAMMABLE flashpoint not less than 23°C	–	6.1	3347
PHENOXYACETIC ACID DERIVATIVE PESTICIDE, SOLID, TOXIC	–	6.1	3345
Phenthoate, <i>see</i> ORGANOPHOSPHORUS PESTICIDE	P	–	–
PHENYLACETONITRILE, LIQUID	–	6.1	2470
PHENYLACETYL CHLORIDE	–	8	2577
Phenylamine, <i>see</i>	–	6.1	1547
Phenyl bromide, <i>see</i>	P	3	2514
1-Phenylbutane, <i>see</i>	–	3	2709
2-Phenylbutane, <i>see</i>	–	3	2709
Phenyl carbimide, <i>see</i>	–	6.1	2487
PHENYLCARBYLAMINE CHLORIDE	–	6.1	1672
Phenylchloroform, <i>see</i>	–	8	2226
PHENYL CHLOROFORMATE	–	6.1	2746
Phenyl chloromethyl ketone, liquid or solid, <i>see</i>	–	6.1	1697
Phenyl cyanide, <i>see</i>	–	6.1	2224
Phenylcyclohexane, <i>see</i>	P	9	3082
Phenylidichlorophosphine, <i>see</i>	–	8	2798
Phenylidichlorophosphine sulphide, <i>see</i>	–	8	2799
PHENYLENEDIAMINES ( <i>o</i> -, <i>m</i> -, <i>p</i> -)	–	6.1	1673
Phenylethane, <i>see</i>	–	3	1175
Phenylethylene, stabilized, <i>see</i>	–	3	2055
Phenyl fluoride, <i>see</i>	–	3	2387
PHENYLHYDRAZINE	–	6.1	2572
Phenyliminophosgene, <i>see</i>	–	6.1	1672
PHENYL ISOCYANATE	–	6.1	2487
Phenyl isocyanodichloride, <i>see</i>	–	6.1	1672
PHENYL MERCAPTAN	–	6.1	2337
PHENYLMERCURIC ACETATE	P	6.1	1674
PHENYLMERCURIC COMPOUND, N.O.S.	P	6.1	2026
PHENYLMERCURIC HYDROXIDE	P	6.1	1894
PHENYLMERCURIC NITRATE	P	6.1	1895

Substance, material or article	MP	Class	UN No.
Phenyl methyl carbinol, solid or liquid, <i>see</i>	–	6.1	2937
Phenyl methyl ether, <i>see</i>	–	3	2222
PHENYLPHOSPHORUS DICHLORIDE	–	8	2798
PHENYLPHOSPHORUS THIODICHLORIDE	–	8	2799
2-Phenylpropene, <i>see</i>	–	3	2303
PHENYLTRICHLOROSILANE	–	8	1804
Phenyltrifluoromethane, <i>see</i>	–	3	2338
Phorate, <i>see</i> ORGANOPHOSPHORUS PESTICIDE	P	–	–
Phosalone, <i>see</i> ORGANOPHOSPHORUS PESTICIDE	P	–	–
Phosfolan, <i>see</i> ORGANOPHOSPHORUS PESTICIDE	–	–	–
PHOSGENE	–	2.3	1076
Phosmet, <i>see</i> ORGANOPHOSPHORUS PESTICIDE	P	–	–
9-PHOSPHABICYCLONANES	–	4.2	2940
Phosphamidon, <i>see</i> ORGANOPHOSPHORUS PESTICIDE	P	–	–
PHOSPHINE	–	2.3	2199
Phosphoretted hydrogen, <i>see</i>	–	2.3	2199
PHOSPHORIC ACID, SOLID	–	8	3453
PHOSPHORIC ACID SOLUTION	–	8	1805
Phosphoric anhydride, <i>see</i>	–	8	1807
Phosphoric chloride, <i>see</i>	–	8	1806
Phosphoric pentachloride, <i>see</i>	–	8	1806
Phosphoric perchloride, <i>see</i>	–	8	1806
PHOSPHOROUS ACID	–	8	2834
PHOSPHORUS, AMORPHOUS	–	4.1	1338
Phosphorus bromide, <i>see</i>	–	8	1808
Phosphorus chloride, <i>see</i>	–	6.1	1809
PHOSPHORUS HEPTASULPHIDE free from yellow or white phosphorus	–	4.1	1339
PHOSPHORUS OXYBROMIDE, MOLTEN	–	8	2576
PHOSPHORUS OXYBROMIDE	–	8	1939
PHOSPHORUS OXYCHLORIDE	–	6.1	1810
PHOSPHORUS PENTABROMIDE	–	8	2691
PHOSPHORUS PENTACHLORIDE	–	8	1806
PHOSPHORUS PENTAFLUORIDE	–	2.3	2198
PHOSPHORUS PENTASULPHIDE free from yellow or white phosphorus	–	4.3	1340
PHOSPHORUS PENTOXIDE	–	8	1807
Phosphorus, red, <i>see</i>	–	4.1	1338
PHOSPHORUS SESQUISULPHIDE free from yellow or white phosphorus	–	4.1	1341
Phosphorus(V) sulphide, free from from yellow or white phosphorus, <i>see</i>	–	4.3	1340
Phosphorus sulphochloride, <i>see</i>	–	8	1837
PHOSPHORUS TRIBROMIDE	–	8	1808
PHOSPHORUS TRICHLORIDE	–	6.1	1809
PHOSPHORUS TRIOXIDE	–	8	2578



Index

Substance, material or article	MP	Class	UN No.
PHOSPHORUS TRISULPHIDE free from yellow or white phosphorus	–	4.1	1343
PHOSPHORUS, WHITE, DRY	P	4.2	1381
PHOSPHORUS, WHITE, IN SOLUTION	P	4.2	1381
PHOSPHORUS, WHITE, MOLTEN	P	4.2	2447
PHOSPHORUS, WHITE, UNDER WATER	P	4.2	1381
PHOSPHORUS, YELLOW, DRY	P	4.2	1381
PHOSPHORUS, YELLOW, IN SOLUTION	P	4.2	1381
PHOSPHORUS, YELLOW, UNDER WATER	P	4.2	1381
Phosphoryl bromide, molten, <i>see</i>	–	8	2576
Phosphoryl bromide, solid, <i>see</i>	–	8	1939
Phosphoryl chloride, <i>see</i>	–	6.1	1810
PHTHALIC ANHYDRIDE with more than 0.05% of maleic anhydride	–	8	2214
PICOLINES	–	3	2313
Picramic acid, wetted with not less than 20% water, by mass, <i>see</i>	–	4.1	3317
PICRAMIDE	–	1.1D	0153
PICRIC ACID dry or wetted with less than 30% water, by mass	–	1.1D	0154
PICRIC ACID, WETTED with not less than 10% water, by mass	–	4.1	3364
PICRIC ACID, WETTED with not less than 30% water, by mass	–	4.1	1344
PICRITE dry or wetted with less than 20% water, by mass	–	1.1D	0282
PICRITE, WETTED with not less than 20% water, by mass	–	4.1	1336
PICRYL CHLORIDE	–	1.1D	0155
PICRYL CHLORIDE, WETTED with not less than 10% water, by mass	–	4.1	3365
Pinanyl hydroperoxide (concentration ≤56%, with diluent Type A), <i>see</i>	–	5.2	3109
Pinanyl hydroperoxide (concentration >56–100%), <i>see</i>	–	5.2	3105
Pindone (and salts of), <i>see</i> PESTICIDE, N.O.S.	P	–	–
<i>alpha</i> -PINENE	–	3	2368
PINE OIL	–	3	1272
PIPERAZINE	–	8	2579
PIPERIDINE	–	8	2401
Pirimicarb, <i>see</i> CARBAMATE PESTICIDE	P	–	–
Pirimiphos-ethyl, <i>see</i> ORGANOPHOSPHORUS PESTICIDE	P	–	–
Pivaloyl chloride, <i>see</i>	–	6.1	2438
Plastic explosives, <i>see</i>	–	1.1D	0084
PLASTICS MOULDING COMPOUND in dough, sheet or extruded rope form, evolving flammable vapour	–	9	3314
PLASTICS, NITROCELLULOSE-BASED, SELF-HEATING, N.O.S.	–	4.2	2006
Platinic chloride, solid, <i>see</i>	–	8	2507
Polish, <i>see</i> PAINT	–	–	–
POLYAMINES, FLAMMABLE, CORROSIVE, N.O.S.	–	3	2733
POLYAMINES, LIQUID, CORROSIVE, FLAMMABLE, N.O.S.	–	8	2734
POLYAMINES, LIQUID, CORROSIVE, N.O.S.	–	8	2735
POLYAMINES, SOLID, CORROSIVE, N.O.S.	–	8	3259
POLYCHLORINATED BIPHENYLS, LIQUID	P	9	2315

Substance, material or article	MP	Class	UN No.
POLYCHLORINATED BIPHENYLS, SOLID	P	9	3432
POLYESTER RESIN KIT	–	3	3269
Polyether poly- <i>tert</i> -butylperoxycarbonate (concentration ≤52%, with diluent Type B), see	–	5.2	3107
POLYHALOGENATED BIPHENYLS, LIQUID	P	9	3151
POLYHALOGENATED BIPHENYLS, SOLID	P	9	3152
POLYHALOGENATED TERPHENYLS, LIQUID	P	9	3151
POLYHALOGENATED TERPHENYLS, SOLID	P	9	3152
POLYMERIC BEADS, EXPANDABLE evolving flammable vapour	–	9	2211
Polystyrene beads, expandable, see	–	9	2211
Polystyrene beads, expandable, evolving flammable vapour, see	–	9	2211
POTASSIUM	–	4.3	2257
Potassium acid fluoride, solid, see	–	8	1811
Potassium acid fluoride solution, see	–	8	1811
Potassium alloys, metal, see	–	4.3	1420
Potassium amalgams, liquid, see	–	4.3	1389
Potassium amalgams, solid, see	–	4.3	3401
Potassium amide, see	–	4.3	1390
Potassium antimony tartrate, see	–	6.1	1551
POTASSIUM ARSENATE	–	6.1	1677
POTASSIUM ARSENITE	–	6.1	1678
Potassium bifluoride, solid, see	–	8	1811
Potassium bifluoride solution, see	–	8	3421
Potassium bisulphate, see	–	8	2509
Potassium bisulphite solution, see	–	8	2693
POTASSIUM BOROHYDRIDE	–	4.3	1870
POTASSIUM BROMATE	–	5.1	1484
POTASSIUM CHLORATE	–	5.1	1485
POTASSIUM CHLORATE, AQUEOUS SOLUTION	–	5.1	2427
Potassium chlorate mixed with mineral oil, see	–	1.1D	0083
POTASSIUM CUPROCYANIDE	P	6.1	1679
POTASSIUM CYANIDE, SOLID	P	6.1	1680
POTASSIUM CYANIDE SOLUTION	P	6.1	3413
Potassium cyanocuprate(I), see	P	6.1	1679
Potassium cyanomercurate, see	P	6.1	1626
Potassium dicyanocuprate(I), see	–	6.1	1679
Potassium dihydrogen arsenate, see	–	6.1	1677
Potassium dispersions, see	–	4.3	1391
POTASSIUM DITHIONITE	–	4.2	1929
POTASSIUM FLUORIDE, SOLID	–	6.1	1812
POTASSIUM FLUORIDE SOLUTION	–	6.1	3422
POTASSIUM FLUOROACETATE	–	6.1	2628
POTASSIUM FLUROSILICATE	–	6.1	2655

Index

Substance, material or article	MP	Class	UN No.
Potassium hexafluorosilicate, <i>see</i>	–	6.1	2655
Potassium hydrate, <i>see</i>	–	8	1814
POTASSIUM HYDROGEN DIFLUORIDE, SOLID	–	8	1811
POTASSIUM HYDROGEN DIFLUORIDE SOLUTION	–	8	3421
Potassium hydrogen fluoride, solid, <i>see</i>	–	8	1811
Potassium hydrogen fluoride solution, <i>see</i>	–	8	3421
POTASSIUM HYDROGEN SULPHATE	–	8	2509
POTASSIUM HYDROSULPHITE	–	4.2	1929
Potassium hydroxide, liquid, <i>see</i>	–	8	1814
POTASSIUM HYDROXIDE, SOLID	–	8	1813
POTASSIUM HYDROXIDE SOLUTION	–	8	1814
Potassium hypochlorite solution, <i>see</i>	–	8	1791
Potassium mercuric iodide, <i>see</i>	P	6.1	1643
POTASSIUM METAL ALLOYS, LIQUID	–	4.3	1420
POTASSIUM METAL ALLOYS, SOLID	–	4.3	3403
POTASSIUM METAVANADATE	–	6.1	2864
POTASSIUM MONOXIDE	–	8	2033
POTASSIUM NITRATE	–	5.1	1486
Potassium nitrate and sodium nitrate mixture, <i>see</i>	–	5.1	1499
POTASSIUM NITRATE AND SODIUM NITRITE MIXTURE	–	5.1	1487
POTASSIUM NITRITE	–	5.1	1488
Potassium oxide, <i>see</i>	–	8	2033
POTASSIUM PERCHLORATE	–	5.1	1489
POTASSIUM PERMANGANATE	–	5.1	1490
POTASSIUM PEROXIDE	–	5.1	1491
POTASSIUM PERSULPHATE	–	5.1	1492
POTASSIUM PHOSPHIDE	–	4.3	2012
Potassium silicofluoride, <i>see</i>	–	6.1	2655
POTASSIUM SODIUM ALLOYS, LIQUID	–	4.3	1422
POTASSIUM SODIUM ALLOYS, SOLID	–	4.3	3404
POTASSIUM SULPHIDE, ANHYDROUS	–	4.2	1382
POTASSIUM SULPHIDE, HYDRATED with not less than 30% water of crystallization	–	8	1847
POTASSIUM SULPHIDE with less than 30% water of crystallization	–	4.2	1382
POTASSIUM SUPEROXIDE	–	5.1	2466
Potassium tetracyanomercurate(II), <i>see</i>	–	6.1	1626
Potassium vanadate, <i>see</i>	–	6.1	2864
POWDER CAKE, WETTED with not less than 17% alcohol, by mass	–	1.1C	0433
POWDER CAKE, WETTED with not less than 25% water, by mass	–	1.3C	0159
POWDER PASTE, WETTED with not less than 17% alcohol, by mass	–	1.1C	0433
POWDER PASTE, WETTED with not less than 25% water, by mass	–	1.3C	0159
POWDER, SMOKELESS	–	1.1C	0160
POWDER, SMOKELESS	–	1.3C	0161

Substance, material or article	MP	Class	UN No.
POWDER, SMOKELESS	–	1.4C	0509
Power devices, explosive, <i>see</i> CARTRIDGES, POWER DEVICE	–	–	–
Praseodymium nitrate and neodymium nitrate mixture, <i>see</i>	–	5.1	1465
PRIMERS, CAP TYPE	–	1.1B	0377
PRIMERS, CAP TYPE	–	1.4B	0378
PRIMERS, CAP TYPE	–	1.4S	0044
Primers, small arms, <i>see</i>	–	1.4S	0044
PRIMERS, TUBULAR	–	1.3G	0319
PRIMERS, TUBULAR	–	1.4G	0320
PRIMERS, TUBULAR	–	1.4S	0376
PRINTING INK flammable	–	3	1210
PRINTING INK RELATED MATERIAL (including printing ink thinning or reducing compound), flammable	–	3	1210
Projectiles, illuminating, <i>see</i> AMMUNITION, ILLUMINATING	–	–	–
PROJECTILES inert, with tracer	–	1.3G	0424
PROJECTILES inert, with tracer	–	1.4G	0425
PROJECTILES inert, with tracer	–	1.4S	0345
PROJECTILES with burster or expelling charge	–	1.2D	0346
PROJECTILES with burster or expelling charge	–	1.2F	0426
PROJECTILES with burster or expelling charge	–	1.2G	0434
PROJECTILES with burster or expelling charge	–	1.4D	0347
PROJECTILES with burster or expelling charge	–	1.4F	0427
PROJECTILES with burster or expelling charge	–	1.4G	0435
PROJECTILES with bursting charge	–	1.1D	0168
PROJECTILES with bursting charge	–	1.1F	0167
PROJECTILES with bursting charge	–	1.2D	0169
PROJECTILES with bursting charge	–	1.2F	0324
PROJECTILES with bursting charge	–	1.4D	0344
Promecarb, <i>see</i> CARBAMATE PESTICIDE	P	–	–
Promurit, <i>see</i> CARBAMATE PESTICIDE	–	–	–
Propachlor, <i>see</i> Note 1	P	–	–
Propadiene and methyacetylene mixture, stabilized, <i>see</i>	–	2.1	1060
PROPADIENE, STABILIZED	–	2.1	2200
PROPANE	–	2.1	1978
PROPANETHIOLS	–	3	2402
<i>n</i> -PROPANOL (PROPYL ALCOHOL, NORMAL)	–	3	1274
1-Propanol, <i>see</i>	–	3	1274
2-Propanol, <i>see</i>	–	3	1219
2-Propanone, <i>see</i>	–	3	1090
2-Propanone solutions, <i>see</i>	–	3	1090
Propanoyl chloride, <i>see</i>	–	3	1815
Propaphos, <i>see</i> ORGANOPHOSPHORUS PESTICIDE	P	–	–
Propargyl bromide, <i>see</i>	–	3	2345

Index

Substance, material or article	MP	Class	UN No.
PROPELLANT, LIQUID	–	1.1C	0497
PROPELLANT, LIQUID	–	1.3C	0495
PROPELLANT, SOLID	–	1.1C	0498
PROPELLANT, SOLID	–	1.3C	0499
PROPELLANT, SOLID	–	1.4C	0501
Propellants, single, double or triple base, <i>see</i> POWDER, SMOKELESS	–	–	–
Propenal, stabilized, <i>see</i>	P	6.1	1092
Propene, <i>see</i>	–	2.1	1077
Propenenitrile, stabilized, <i>see</i>	–	3	1093
2-Propenoic acid dimethylaminoethyl ester, <i>see</i>	–	6.1	3302
Propenoic acid, stabilized, <i>see</i>	–	8	2218
3-(2-Propenoxy)propene, <i>see</i>	–	3	2360
Propenyl alcohol, <i>see</i>	–	6.1	1098
2-Propenylamine, <i>see</i>	–	6.1	2334
<i>alpha</i> -Propenyldichlorohydrin, <i>see</i>	–	6.1	2750
PROPIONALDEHYDE	–	3	1275
PROPIONIC ACID with not less than 10% and less than 90% acid, by mass	–	8	1848
PROPIONIC ACID with not less than 90% acid, by mass	–	8	3463
Propionic aldehyde, <i>see</i>	–	3	1275
PROPIONIC ANHYDRIDE	–	8	2496
PROPIONITRILE	–	3	2404
PROPIONYL CHLORIDE	–	3	1815
Propoxur, <i>see</i> CARBAMATE PESTICIDE	P	–	–
1-Propoxypropane, <i>see</i>	–	3	2384
<i>n</i> -PROPYL ACETATE	–	3	1276
<i>n</i> -Propyl alcohol, <i>see</i>	–	3	1274
PROPYL ALCOHOL, NORMAL	–	3	1274
Propyl aldehyde, <i>see</i>	–	3	1275
PROPYLAMINE	–	3	1277
<i>n</i> -PROPYLBENZENE	–	3	2364
Propyl bromides, <i>see</i>	–	3	2344
Propyl chloride, <i>see</i>	–	3	1278
Propyl chlorocarbonate, <i>see</i>	–	6.1	2740
<i>n</i> -PROPYL CHLOROFORMATE	–	6.1	2740
Propyl cyanide, <i>see</i>	–	3	2411
PROPYLENE	–	2.1	1077
Propylene, acetylene and ethylene mixture, refrigerated liquid, <i>see</i>	–	2.1	3138
PROPYLENE CHLOROHYDRIN	–	6.1	2611
1,2-PROPYLENEDIAMINE	–	8	2258
Propylene dichloride, <i>see</i>	–	3	1279
PROPYLENEIMINE, STABILIZED	–	3	1921
PROPYLENE OXIDE	–	3	1280

Substance, material or article	MP	Class	UN No.
PROPYLENE TETRAMER	–	3	2850
Propylene trimer, <i>see</i>	–	3	2057
Propyl ether, <i>see</i>	–	3	2384
PROPYL FORMATES	–	3	1281
Propylformic acid, <i>see</i>	–	8	2820
Propylidene dichloride, <i>see</i>	–	3	1993
Propyl iodides, <i>see</i>	–	3	2392
<i>n</i> -PROPYL ISOCYANATE	–	6.1	2482
Propyl mercaptan, <i>see</i>	–	3	2402
Propyl methanoates, <i>see</i>	–	3	1281
<i>n</i> -PROPYL NITRATE	–	3	1865
PROPYLTRICHLOROSILANE	–	8	1816
Prothoate, <i>see</i> ORGANOPHOSPHORUS PESTICIDE	P	–	–
Prussic acid, anhydrous, stabilized, containing less than 3% water, <i>see</i>	P	6.1	1051
Prussic acid, anhydrous, stabilized, containing less than 3% water and absorbed in a porous inert material, <i>see</i>	P	6.1	1614
Prussic acid, aqueous solution, <i>see</i>	P	6.1	1613
Prussic acid, aqueous solution with not more than 20% hydrogen cyanide, <i>see</i>	P	6.1	1613
Pyrazine hexahydride, solid, <i>see</i>	–	8	2579
Pyrazophos, <i>see</i> ORGANOPHOSPHORUS PESTICIDE	P	–	–
Pyrazoxon, <i>see</i> ORGANOPHOSPHORUS PESTICIDE	–	–	–
PYRETHROID PESTICIDE, LIQUID, FLAMMABLE, TOXIC, flashpoint less than 23°C	–	3	3350
PYRETHROID PESTICIDE, LIQUID, TOXIC	–	6.1	3352
PYRETHROID PESTICIDE, LIQUID, TOXIC, FLAMMABLE, flashpoint not less than 23°C	–	6.1	3351
PYRETHROID PESTICIDE, SOLID, TOXIC	–	6.1	3349
PYRIDINE	–	3	1282
PYROPHORIC ALLOY, N.O.S.	–	4.2	1383
Pyrophoric articles, <i>see</i>	–	1.2L	0380
PYROPHORIC LIQUID, INORGANIC, N.O.S.	–	4.2	3194
PYROPHORIC LIQUID, ORGANIC, N.O.S.	–	4.2	2845
PYROPHORIC METAL, N.O.S.	–	4.2	1383
Pyrophoric organometallic compound, water-reactive, liquid, <i>see</i>	–	4.2	3394
Pyrophoric organometallic compound, water-reactive, solid, <i>see</i>	–	4.2	3393
PYROPHORIC SOLID, INORGANIC, N.O.S.	–	4.2	3200
PYROPHORIC SOLID, ORGANIC, N.O.S.	–	4.2	2846
Pyrosulphuric acid, <i>see</i>	–	8	1831
PYROSULPHURYL CHLORIDE	–	8	1817
Pyroxylin solution, <i>see</i>	–	3	2059
PYRROLIDINE	–	3	1922
Quinalphos, <i>see</i> ORGANOPHOSPHORUS PESTICIDE	P	–	–

Index

Substance, material or article	MP	Class	UN No.
QUINOLINE	–	6.1	2656
Quinone, see	–	6.1	2587
Quizalofop, see Note 1	P	–	–
Quizalofop-P-ethyl, see Note 1	P	–	–
Racumin, see COUMARIN DERIVATIVE PESTICIDE	–	–	–
Radioactive isotopes ( $A_1$ and $A_2$ values for), see 2.7.2.2	–	–	–
RADIOACTIVE MATERIAL, EXCEPTED PACKAGE – ARTICLES	–	7	2911
RADIOACTIVE MATERIAL, EXCEPTED PACKAGE – ARTICLES MANUFACTURED FROM DEPLETED URANIUM	–	7	2909
RADIOACTIVE MATERIAL, EXCEPTED PACKAGE – ARTICLES MANUFACTURED FROM NATURAL THORIUM	–	7	2909
RADIOACTIVE MATERIAL, EXCEPTED PACKAGE – ARTICLES MANUFACTURED FROM NATURAL URANIUM	–	7	2909
RADIOACTIVE MATERIAL, EXCEPTED PACKAGE – EMPTY PACKAGING	–	7	2908
RADIOACTIVE MATERIAL, EXCEPTED PACKAGE – INSTRUMENTS	–	7	2911
RADIOACTIVE MATERIAL, EXCEPTED PACKAGE – LIMITED QUANTITY OF MATERIAL	–	7	2910
RADIOACTIVE MATERIAL, LOW SPECIFIC ACTIVITY (LSA-II), FISSILE	–	7	3324
RADIOACTIVE MATERIAL, LOW SPECIFIC ACTIVITY (LSA-III), FISSILE	–	7	3325
RADIOACTIVE MATERIAL, LOW SPECIFIC ACTIVITY (LSA-I), non fissile or fissile – excepted	–	7	2912
RADIOACTIVE MATERIAL, LOW SPECIFIC ACTIVITY (LSA-II), non fissile or fissile – excepted	–	7	3321
RADIOACTIVE MATERIAL, LOW SPECIFIC ACTIVITY (LSA-III), non fissile or fissile – excepted	–	7	3322
RADIOACTIVE MATERIAL, SURFACE CONTAMINATED OBJECTS (SCO-I or SCO-II), FISSILE	–	7	3326
RADIOACTIVE MATERIAL, SURFACE CONTAMINATED OBJECTS (SCO-I or SCO-II), non fissile or fissile – excepted	–	7	2913
RADIOACTIVE MATERIAL, TRANSPORTED UNDER SPECIAL ARRANGEMENT, FISSILE	–	7	3331
RADIOACTIVE MATERIAL TRANSPORTED UNDER SPECIAL ARRANGEMENT non fissile or fissile – excepted	–	7	2919
RADIOACTIVE MATERIAL, TYPE A PACKAGE, FISSILE, non-special form	–	7	3327
RADIOACTIVE MATERIAL, TYPE A PACKAGE, non-special form, non fissile or fissile – excepted	–	7	2915
RADIOACTIVE MATERIAL, TYPE A PACKAGE, SPECIAL FORM, FISSILE	–	7	3333
RADIOACTIVE MATERIAL, TYPE A PACKAGE, SPECIAL FORM, non fissile or fissile – excepted	–	7	3332
RADIOACTIVE MATERIAL, TYPE B(M) PACKAGE, FISSILE	–	7	3329
RADIOACTIVE MATERIAL, TYPE B(M) PACKAGE, non fissile or fissile – excepted	–	7	2917
RADIOACTIVE MATERIAL TYPE B(U) PACKAGE, FISSILE	–	7	3328
RADIOACTIVE MATERIAL, TYPE B(U) PACKAGE, non fissile or fissile – excepted	–	7	2916

Substance, material or article	MP	Class	UN No.
RADIOACTIVE MATERIAL, TYPE C PACKAGE, FISSILE	–	7	3330
RADIOACTIVE MATERIAL, TYPE C PACKAGE, non fissile or fissile – excepted	–	7	3323
RADIOACTIVE MATERIAL, URANIUM HEXAFLUORIDE, FISSILE	–	7	2977
RADIOACTIVE MATERIAL, URANIUM HEXAFLUORIDE, non fissile or fissile – excepted	–	7	2978
Radionuclides ( $A_1$ and $A_2$ values for), see 2.7.2.2	–	–	–
RAGS, OILY	–	4.2	1856
Railway fuseses, see SIGNAL DEVICES, HAND	–	–	–
RDX AND CYCLOTETRAMETHYLENETETRANITRAMINE MIXTURE, DESENSITIZED with not less than 10% phlegmatizer, by mass	–	1.1D	0391
RDX AND CYCLOTETRAMETHYLENETETRANITRAMINE MIXTURE, WETTED with not less than 15% water, by mass	–	1.1D	0391
RDX AND HMX MIXTURE, DESENSITIZED with not less than 10% phlegmatizer, by mass	–	1.1D	0391
RDX AND HMX MIXTURE, WETTED with not less than 15% water, by mass	–	1.1D	0391
RDX AND OCTOGEN MIXTURE, DESENSITIZED with not less than 10% phlegmatizer, by mass	–	1.1D	0391
RDX AND OCTOGEN MIXTURE, WETTED with not less than 15% water, by mass	–	1.1D	0391
RDX, DESENSITIZED	–	1.1D	0483
RDX/TNT, see	–	1.1D	0118
RDX/TNT/aluminium, see	–	1.1D	0393
RDX, WETTED with not less than 15% water, by mass	–	1.1D	0072
RECEPTACLES, SMALL, CONTAINING GAS without a release device, non refillable	–	2	2037
Red phosphorus, see	–	4.1	1338
REFRIGERANT GAS, N.O.S.	–	2.2	1078
REFRIGERANT GAS R 12	–	2.2	1028
REFRIGERANT GAS R 12B1	–	2.2	1974
REFRIGERANT GAS R 13	–	2.2	1022
REFRIGERANT GAS R 13B1	–	2.2	1009
REFRIGERANT GAS R 14	–	2.2	1982
REFRIGERANT GAS R 21	–	2.2	1029
REFRIGERANT GAS R 22	–	2.2	1018
REFRIGERANT GAS R 23	–	2.2	1984
REFRIGERANT GAS R 32	–	2.1	3252
REFRIGERANT GAS R 40	–	2.1	1063
REFRIGERANT GAS R 41	–	2.1	2454
REFRIGERANT GAS R 114	–	2.2	1958
REFRIGERANT GAS R 115	–	2.2	1020
REFRIGERANT GAS R 116	–	2.2	2193
REFRIGERANT GAS R 124	–	2.2	1021
REFRIGERANT GAS R 125	–	2.2	3220
REFRIGERANT GAS R 133a	–	2.2	1983



Index

Substance, material or article	MP	Class	UN No.
REFRIGERANT GAS R 134a	–	2.2	3159
REFRIGERANT GAS R 142b	–	2.1	2517
REFRIGERANT GAS R 143a	–	2.1	2035
REFRIGERANT GAS R 152a	–	2.1	1030
REFRIGERANT GAS R 161	–	2.1	2453
REFRIGERANT GAS R 218	–	2.2	2424
REFRIGERANT GAS R 227	–	2.2	3296
REFRIGERANT GAS R 404A	–	2.2	3337
REFRIGERANT GAS R 407A	–	2.2	3338
REFRIGERANT GAS R 407B	–	2.2	3339
REFRIGERANT GAS R 407C	–	2.2	3340
REFRIGERANT GAS R 500	–	2.2	2602
REFRIGERANT GAS R 502	–	2.2	1973
REFRIGERANT GAS R 503	–	2.2	2599
REFRIGERANT GAS R 1113	–	2.3	1082
REFRIGERANT GAS R 1132a	–	2.1	1959
REFRIGERANT GAS R 1216	–	2.2	1858
REFRIGERANT GAS R 1318	–	2.2	2422
REFRIGERANT GAS RC 318	–	2.2	1976
REFRIGERATING MACHINES containing flammable, non-toxic, liquefied gas	–	2.1	3358
REFRIGERATING MACHINES containing non-flammable, non-toxic gases or ammonia solution (UN 2672)	–	2.2	2857
REGULATED MEDICAL WASTE, N.O.S.	–	6.2	3291
RELEASE DEVICES, EXPLOSIVE	–	1.4S	0173
RESIN SOLUTION flammable	–	3	1866
Resorcin, <i>see</i>	–	6.1	2876
RESORCINOL	–	6.1	2876
RIVETS, EXPLOSIVE	–	1.4S	0174
Road asphalt, <i>see</i>	–	3	1999
ROCKET MOTORS	–	1.1C	0280
ROCKET MOTORS	–	1.2C	0281
ROCKET MOTORS	–	1.3C	0186
ROCKET MOTORS, LIQUID FUELLED	–	1.2J	0395
ROCKET MOTORS, LIQUID FUELLED	–	1.3J	0396
ROCKET MOTORS WITH HYPERGOLIC LIQUIDS with or without expelling charge	–	1.2L	0322
ROCKET MOTORS WITH HYPERGOLIC LIQUIDS with or without expelling charge	–	1.3L	0250
ROCKETS, LINE-THROWING	–	1.2G	0238
ROCKETS, LINE-THROWING	–	1.3G	0240
ROCKETS, LINE-THROWING	–	1.4G	0453
ROCKETS, LIQUID FUELLED with bursting charge	–	1.1J	0397
ROCKETS, LIQUID FUELLED with bursting charge	–	1.2J	0398

Substance, material or article	MP	Class	UN No.
ROCKETS with bursting charge	–	1.1E	0181
ROCKETS with bursting charge	–	1.1F	0180
ROCKETS with bursting charge	–	1.2E	0182
ROCKETS with bursting charge	–	1.2F	0295
ROCKETS with expelling charge	–	1.2C	0436
ROCKETS with expelling charge	–	1.3C	0437
ROCKETS with expelling charge	–	1.4C	0438
ROCKETS with inert head	–	1.2C	0502
ROCKETS with inert head	–	1.3C	0183
ROSIN OIL	–	3	1286
Rotenone, <i>see</i> PESTICIDE, N.O.S.	P	–	–
RUBBER SCRAP powdered or granulated, not exceeding 840 microns and rubber content exceeding 45%	–	4.1	1345
RUBBER SOLUTION	–	3	1287
RUBIDIUM	–	4.3	1423
Rubidium alloy (liquid), <i>see</i>	–	4.3	1421
Rubidium amalgams, liquid, <i>see</i>	–	4.3	1389
Rubidium amalgams, solid, <i>see</i>	–	4.3	3401
Rubidium amide, <i>see</i>	–	4.3	1390
Rubidium dispersion, <i>see</i>	–	4.3	1391
Rubidium nitrate, <i>see</i>	–	5.1	1477
RUBIDIUM HYDROXIDE	–	8	2678
RUBIDIUM HYDROXIDE SOLUTION	–	8	2677
Salithion, <i>see</i> ORGANOPHOSPHORUS PESTICIDE	P	–	–
Saltpetre, <i>see</i>	–	5.1	1486
SAMPLES, EXPLOSIVE other than initiating explosive	–	1	0190
Sand acid, <i>see</i>	–	8	1778
Schradan, <i>see</i> ORGANOPHOSPHORUS PESTICIDE	–	–	–
SEAT-BELT PRETENSIONERS	–	1.4G	0503
SEAT-BELT PRETENSIONERS	–	9	3268
SEED CAKE, containing vegetable oil (a) mechanically expelled seeds, containing more than 10% of oil or more than 20% of oil and moisture combined	–	4.2	1386
SEED CAKE, containing vegetable oil (b) solvent extractions and expelled seeds, containing not more than 10% of oil and when the amount of moisture is higher than 10%, not more than 20% of oil and moisture combined	–	4.2	1386
SEED CAKE with not more than 1.5% oil and not more than 11% moisture	–	4.2	2217
Seed expellers, oily, <i>see</i>	–	4.2	1386
SELENATES	–	6.1	2630
SELENIC ACID	–	8	1905
Seleninyl chloride, <i>see</i>	–	8	2879
SELENITES	–	6.1	2630

Index

Substance, material or article	MP	Class	UN No.
SELENIUM COMPOUND, LIQUID, N.O.S.	–	6.1	3440
SELENIUM COMPOUND, SOLID, N.O.S.	–	6.1	3283
SELENIUM DISULPHIDE	–	6.1	2657
SELENIUM HEXAFLUORIDE	–	2.3	2194
Selenium hydride, <i>see</i>	–	2.3	2202
SELENIUM OXYCHLORIDE	–	8	2879
SELF-HEATING LIQUID, CORROSIVE, INORGANIC, N.O.S.	–	4.2	3188
SELF-HEATING LIQUID, CORROSIVE, ORGANIC, N.O.S.	–	4.2	3185
SELF-HEATING LIQUID, INORGANIC, N.O.S.	–	4.2	3186
SELF-HEATING LIQUID, ORGANIC, N.O.S.	–	4.2	3183
SELF-HEATING LIQUID, TOXIC, INORGANIC, N.O.S.	–	4.2	3187
SELF-HEATING LIQUID, TOXIC, ORGANIC, N.O.S.	–	4.2	3184
SELF-HEATING SOLID, CORROSIVE, INORGANIC, N.O.S.	–	4.2	3192
SELF-HEATING SOLID, CORROSIVE, ORGANIC, N.O.S.	–	4.2	3126
SELF-HEATING SOLID, INORGANIC, N.O.S.	–	4.2	3190
SELF-HEATING SOLID, ORGANIC, N.O.S.	–	4.2	3088
SELF-HEATING SOLID, OXIDIZING, N.O.S.	–	4.2	3127
SELF-HEATING SOLID, TOXIC, INORGANIC, N.O.S.	–	4.2	3191
SELF-HEATING SOLID, TOXIC, ORGANIC, N.O.S.	–	4.2	3128
Self-reactive liquid, sample, <i>see</i>	–	4.1	3223
Self-reactive liquid, sample, temperature controlled, <i>see</i>	–	4.1	3233
SELF-REACTIVE LIQUID TYPE B	–	4.1	3221
SELF-REACTIVE LIQUID TYPE B, TEMPERATURE CONTROLLED	–	4.1	3231
SELF-REACTIVE LIQUID TYPE C	–	4.1	3223
SELF-REACTIVE LIQUID TYPE C, TEMPERATURE CONTROLLED	–	4.1	3233
SELF-REACTIVE LIQUID TYPE D	–	4.1	3225
SELF-REACTIVE LIQUID TYPE D, TEMPERATURE CONTROLLED	–	4.1	3235
SELF-REACTIVE LIQUID TYPE E	–	4.1	3227
SELF-REACTIVE LIQUID TYPE E, TEMPERATURE CONTROLLED	–	4.1	3237
SELF-REACTIVE LIQUID TYPE F	–	4.1	3229
SELF-REACTIVE LIQUID TYPE F, TEMPERATURE CONTROLLED	–	4.1	3239
Self-reactive solid, sample, <i>see</i>	–	4.1	3224
Self-reactive solid, sample, temperature controlled, <i>see</i>	–	4.1	3234
SELF-REACTIVE SOLID TYPE B	–	4.1	3222
SELF-REACTIVE SOLID TYPE B, TEMPERATURE CONTROLLED	–	4.1	3232
SELF-REACTIVE SOLID TYPE C	–	4.1	3224
SELF-REACTIVE SOLID TYPE C, TEMPERATURE CONTROLLED	–	4.1	3234
SELF-REACTIVE SOLID TYPE D	–	4.1	3226
SELF-REACTIVE SOLID TYPE D, TEMPERATURE CONTROLLED	–	4.1	3236
SELF-REACTIVE SOLID TYPE E	–	4.1	3228
SELF-REACTIVE SOLID TYPE E, TEMPERATURE CONTROLLED	–	4.1	3238
SELF-REACTIVE SOLID TYPE F	–	4.1	3230
SELF-REACTIVE SOLID TYPE F, TEMPERATURE CONTROLLED	–	4.1	3240

Substance, material or article	MP	Class	UN No.
SHALE OIL	–	3	1288
Shaped charges, <i>see</i> CHARGES, SHAPED	–	–	–
Shellac, <i>see</i> PAINT	–	–	–
SIGNAL DEVICES, HAND	–	1.4G	0191
SIGNAL DEVICES, HAND	–	1.4S	0373
SIGNALS, DISTRESS, ship	–	1.1G	0194
SIGNALS, DISTRESS, ship	–	1.3G	0195
SIGNALS, DISTRESS, ship	–	1.4G	0505
SIGNALS, DISTRESS, ship	–	1.4S	0506
Signals, distress, ship, water-activated, <i>see</i> CONTRIVANCES, WATER-ACTIVATED	–	–	–
SIGNALS, RAILWAY TRACK, EXPLOSIVE	–	1.1G	0192
SIGNALS, RAILWAY TRACK, EXPLOSIVE	–	1.3G	0492
SIGNALS, RAILWAY TRACK, EXPLOSIVE	–	1.4G	0493
SIGNALS, RAILWAY TRACK, EXPLOSIVE	–	1.4S	0193
SIGNALS, SMOKE	–	1.1G	0196
SIGNALS, SMOKE	–	1.2G	0313
SIGNALS, SMOKE	–	1.3G	0487
SIGNALS, SMOKE	–	1.4G	0197
SIGNALS, SMOKE	–	1.4S	0507
Silafluofen, <i>see</i> Note 1	P	–	–
SILANE	–	2.1	2203
Silicofluoric acid, <i>see</i>	–	8	1778
Silicofluorides, n.o.s., <i>see</i>	–	6.1	2856
Silicon chloride, <i>see</i>	–	8	1818
SILICON POWDER, AMORPHOUS	–	4.1	1346
SILICON TETRACHLORIDE	–	8	1818
SILICON TETRAFLUORIDE	–	2.3	1859
Silicon tetrahydride, compressed, <i>see</i>	–	2.1	2203
SILVER ARSENITE	P	6.1	1683
SILVER CYANIDE	P	6.1	1684
SILVER NITRATE	–	5.1	1493
Silver orthoarsenite, <i>see</i>	P	6.1	1683
SILVER PICRATE, dry or wetted with less than 30% water, by mass (transport prohibited)	–	–	–
SILVER PICRATE, WETTED with not less than 30% water, by mass	–	4.1	1347
Sisal, dry, <i>see</i>	–	4.1	3360
SLUDGE ACID	–	8	1906
Slurry, explosives, <i>see</i> EXPLOSIVES, BLASTING, TYPE E	–	–	–
Smokeless powder, <i>see</i>	–	1.1C	0160
SODA LIME with more than 4% sodium hydroxide	–	8	1907
SODIUM	–	4.3	1428
SODIUM ALUMINATE, SOLID	–	8	2812
SODIUM ALUMINATE SOLUTION	–	8	1819

Index

Substance, material or article	MP	Class	UN No.
SODIUM ALUMINIUM HYDRIDE	–	4.3	2835
Sodium amalgams, liquid, <i>see</i>	–	4.3	1389
Sodium amalgams, solid, <i>see</i>	–	4.3	3401
Sodium amide, <i>see</i>	–	4.3	1390
SODIUM AMMONIUM VANADATE	–	6.1	2863
SODIUM ARSANILATE	–	6.1	2473
SODIUM ARSENATE	–	6.1	1685
SODIUM ARSENITE, AQUEOUS SOLUTION	–	6.1	1686
Sodium arsenite (pesticide), <i>see</i> ARSENICAL PESTICIDE	–	–	–
SODIUM ARSENITE, SOLID	–	6.1	2027
SODIUM AZIDE	–	6.1	1687
Sodium bifluoride, <i>see</i>	–	8	2439
Sodium bisulphite solution, <i>see</i>	–	8	2693
SODIUM BOROHYDRIDE	–	4.3	1426
SODIUM BOROHYDRIDE AND SODIUM HYDROXIDE SOLUTION with not more than 12% sodium borohydride and not more than 40% sodium hydroxide, by mass	–	8	3320
SODIUM BROMATE	–	5.1	1494
SODIUM CACODYLATE	–	6.1	1688
SODIUM CARBONATE PEROXYHYDRATE	–	5.1	3378
SODIUM CHLORATE	–	5.1	1495
SODIUM CHLORATE, AQUEOUS SOLUTION	–	5.1	2428
Sodium chlorate mixed with dinitrotoluene, <i>see</i>	–	1.1D	0083
SODIUM CHLORITE	–	5.1	1496
SODIUM CHLOROACETATE	–	6.1	2659
Sodium copper cyanide, solid, <i>see</i>	P	6.1	2316
Sodium copper cyanide solution, <i>see</i>	P	6.1	2317
SODIUM CUPROCYANIDE, SOLID	P	6.1	2316
SODIUM CUPROCYANIDE SOLUTION	P	6.1	2317
SODIUM CYANIDE, SOLID	P	6.1	1689
SODIUM CYANIDE SOLUTION	P	6.1	3414
Sodium 2-diazo-1-naphthol-4-sulphonate (concentration 100%), <i>see</i>	–	4.1	3226
Sodium 2-diazo-1-naphthol-5-sulphonate (concentration 100%), <i>see</i>	–	4.1	3226
Sodium dicyanocuprate(I), solid, <i>see</i>	P	6.1	2316
Sodium dicyanocuprate(I) solution, <i>see</i>	–	6.1	2317
SODIUM DINITRO- <i>ortho</i> -CRESOLATE dry or wetted with less than 15% water, by mass	P	1.3C	0234
SODIUM DINITRO- <i>o</i> -CRESOLATE, WETTED with not less than 10% water, by mass	P	4.1	3369
SODIUM DINITRO- <i>o</i> -CRESOLATE, WETTED with not less than 15% water, by mass	P	4.1	1348
Sodium dioxide, <i>see</i>	–	5.1	1504
Sodium dispersion, <i>see</i>	–	4.3	1391
SODIUM DITHIONITE	–	4.2	1384
SODIUM FLUORIDE, SOLID	–	6.1	1690

Substance, material or article	MP	Class	UN No.
SODIUM FLUORIDE SOLUTION	–	6.1	3415
SODIUM FLUOROACETATE	–	6.1	2629
SODIUM FLUOROSILICATE	–	6.1	2674
Sodium hexafluorosilicate, <i>see</i>	–	6.1	2674
Sodium hydrate, <i>see</i>	–	8	1824
SODIUM HYDRIDE	–	4.3	1427
Sodium hydrogen 4-aminophenylarsenate, <i>see</i>	–	6.1	2473
SODIUM HYDROGENDIFLUORIDE	–	8	2439
Sodium hydrogen sulphite solution, <i>see</i>	–	8	2693
SODIUM HYDROSULPHIDE with less than 25% water of crystallization	–	4.2	2318
SODIUM HYDROSULPHIDE, HYDRATED with not less than 25% water of crystallization	–	8	2949
SODIUM HYDROSULPHITE	–	4.2	1384
SODIUM HYDROXIDE, SOLID	–	8	1823
SODIUM HYDROXIDE SOLUTION	–	8	1824
Sodium hypochlorite solution, <i>see</i>	–	8	1791
Sodium metaarsenite, <i>see</i>	–	6.1	2027
Sodium metasilicate, <i>see</i>	–	8	3253
Sodium metasilicate pentahydrate, <i>see</i>	–	8	3253
Sodium methoxide, <i>see</i>	–	4.2	1431
Sodium methoxide solutions in alcohols, <i>see</i>	–	3	1289
SODIUM METHYLATE	–	4.2	1431
SODIUM METHYLATE SOLUTION in alcohol	–	3	1289
Sodium monochloroacetate, <i>see</i>	–	6.1	2659
SODIUM MONOXIDE	–	8	1825
SODIUM NITRATE	–	5.1	1498
SODIUM NITRATE AND POTASSIUM NITRATE MIXTURE	–	5.1	1499
SODIUM NITRITE	–	5.1	1500
Sodium nitrite and potassium nitrate mixture, <i>see</i>	–	5.1	1487
Sodium orthoarsenate, <i>see</i>	–	6.1	1685
Sodium oxide, <i>see</i>	–	8	1825
SODIUM PENTACHLOROPHENATE	P	6.1	2567
Sodium perborate, anhydrous, <i>see</i>	–	5.1	3247
SODIUM PERBORATE MONOHYDRATE	–	5.1	3377
Sodium percarbonate, <i>see</i>	–	5.1	3378
SODIUM PERCHLORATE	–	5.1	1502
SODIUM PERMANGANATE	–	5.1	1503
SODIUM PEROXIDE	–	5.1	1504
SODIUM PEROXOBORATE, ANHYDROUS	–	5.1	3247
SODIUM PERSULPHATE	–	5.1	1505
SODIUM PHOSPHIDE	–	4.3	1432
SODIUM PICRAMATE dry or wetted with less than 20% water, by mass	–	1.3C	0235
SODIUM PICRAMATE, WETTED with not less than 20% water, by mass	–	4.1	1349

Index

Substance, material or article	MP	Class	UN No.
Sodium potassium alloys, <i>see</i>	–	4.3	1422
Sodium silicofluoride, <i>see</i>	–	6.1	2674
SODIUM SULPHIDE, ANHYDROUS	–	4.2	1385
SODIUM SULPHIDE, HYDRATED with not less than 30% water	–	8	1849
SODIUM SULPHIDE with less than 30% water of crystallization	–	4.2	1385
Sodium sulphhydrate, <i>see</i>	–	4.2	2318
SODIUM SUPEROXIDE	–	5.1	2547
SOLIDS CONTAINING CORROSIVE LIQUID, N.O.S.	–	8	3244
SOLIDS CONTAINING FLAMMABLE LIQUID, N.O.S.	–	4.1	3175
SOLIDS CONTAINING TOXIC LIQUID, N.O.S.	–	6.1	3243
Solvents, flammable, n.o.s., <i>see</i>	–	3	1993
Solvents, toxic, flammable, n.o.s., <i>see</i>	–	3	1992
SOUNDING DEVICES, EXPLOSIVE	–	1.1D	0374
SOUNDING DEVICES, EXPLOSIVE	–	1.1F	0296
SOUNDING DEVICES, EXPLOSIVE	–	1.2D	0375
SOUNDING DEVICES, EXPLOSIVE	–	1.2F	0204
Squibs, <i>see</i> IGNITERS, UN 0325 and UN 0454	–	–	–
Stain, <i>see</i> PAINT	–	–	–
STANNIC CHLORIDE, ANHYDROUS	–	8	1827
STANNIC CHLORIDE PENTAHYDRATE	–	8	2440
STANNIC PHOSPHIDE	–	4.3	1433
Steel swarf, <i>see</i>	–	4.2	2793
STIBINE	–	2.3	2676
STRAW	–	4.1	1327
Strontium alloy, non-pyrophoric, <i>see</i>	–	4.3	1393
Strontium alloy, pyrophoric, <i>see</i>	–	4.2	1383
Strontium amalgams, liquid, <i>see</i>	–	4.3	1392
Strontium amalgams, solid, <i>see</i>	–	4.3	3402
STRONTIUM ARSENITE	–	6.1	1691
STRONTIUM CHLORATE	–	5.1	1506
Strontium dioxide, <i>see</i>	–	5.1	1509
Strontium dispersion, <i>see</i>	–	4.3	1391
STRONTIUM NITRATE	–	5.1	1507
Strontium orthoarsenite, <i>see</i>	–	6.1	1691
STRONTIUM PERCHLORATE	–	5.1	1508
STRONTIUM PEROXIDE	–	5.1	1509
STRONTIUM PHOSPHIDE	–	4.3	2013
Strontium, powder, <i>see</i>	–	4.2	1383
Strontium powder, pyrophoric, <i>see</i>	–	4.2	1383
STRYCHNINE	P	6.1	1692
Strychnine pesticides, <i>see</i> PESTICIDE, N.O.S.	P	–	–
STRYCHNINE SALTS	P	6.1	1692

Substance, material or article	MP	Class	UN No.
STYPHNIC ACID dry or wetted with less than 20% water, or mixture of alcohol and water, by mass	–	1.1D	0219
STYPHNIC ACID, WETTED with not less than 20% water, or mixture of alcohol and water, by mass	–	1.1D	0394
STYRENE MONOMER, STABILIZED	–	3	2055
SUBSTANCES, EVI, N.O.S.	–	1.5D	0482
SUBSTANCES, EXPLOSIVE, N.O.S.	–	1.1A	0473
SUBSTANCES, EXPLOSIVE, N.O.S.	–	1.1C	0474
SUBSTANCES, EXPLOSIVE, N.O.S.	–	1.1D	0475
SUBSTANCES, EXPLOSIVE, N.O.S.	–	1.1G	0476
SUBSTANCES, EXPLOSIVE, N.O.S.	–	1.1L	0357
SUBSTANCES, EXPLOSIVE, N.O.S.	–	1.2L	0358
SUBSTANCES, EXPLOSIVE, N.O.S.	–	1.3C	0477
SUBSTANCES, EXPLOSIVE, N.O.S.	–	1.3G	0478
SUBSTANCES, EXPLOSIVE, N.O.S.	–	1.3L	0359
SUBSTANCES, EXPLOSIVE, N.O.S.	–	1.4C	0479
SUBSTANCES, EXPLOSIVE, N.O.S.	–	1.4D	0480
SUBSTANCES, EXPLOSIVE, N.O.S.	–	1.4G	0485
SUBSTANCES, EXPLOSIVE, N.O.S.	–	1.4S	0481
SUBSTANCES, EXPLOSIVE, VERY INSENSITIVE, N.O.S.	–	1.5D	0482
SUBSTITUTED NITROPHENOL PESTICIDE, LIQUID, FLAMMABLE, TOXIC, flashpoint less than 23°C	–	3	2780
SUBSTITUTED NITROPHENOL PESTICIDE, LIQUID, TOXIC	–	6.1	3014
SUBSTITUTED NITROPHENOL PESTICIDE, LIQUID, TOXIC, FLAMMABLE, flashpoint not less than 23°C	–	6.1	3013
SUBSTITUTED NITROPHENOL PESTICIDE, SOLID, TOXIC	–	6.1	2779
Sulfotep, see ORGANOPHOSPHORUS PESTICIDE	P	–	–
Sulfur, see Sulphur	–	–	–
SULPHAMIC ACID	–	8	2967
Sulphonyl chloride, see	–	6.1	1834
SULPHUR	–	4.1	1350
SULPHUR CHLORIDES	–	8	1828
Sulphur dichloride, see	–	8	1828
SULPHUR DIOXIDE	–	2.3	1079
Sulphuretted hydrogen, see	–	2.3	1053
SULPHUR HEXAFLUORIDE	–	2.2	1080
Sulphuric acid and hydrofluoric acid mixture, see	–	8	1786
SULPHURIC ACID, FUMING	–	8	1831
SULPHURIC ACID, SPENT	–	8	1832
SULPHURIC ACID with more than 51% acid	–	8	1830
SULPHURIC ACID with not more than 51% acid	–	8	2796
Sulphuric anhydride, stabilized, see	–	8	1829
Sulphuric chloride, see	–	6.1	1834
Sulphuric oxychloride, see	–	6.1	1834



Index

Substance, material or article	MP	Class	UN No.
Sulphuric oxyfluoride, <i>see</i>	–	2.3	2191
SULPHUR, MOLTEN	–	4.1	2448
Sulphur monochloride, <i>see</i>	–	8	1828
SULPHUROUS ACID	–	8	1833
Sulphurous oxychloride, <i>see</i>	–	8	1836
Sulphur oxychloride, <i>see</i>	–	8	1836
SULPHUR TETRAFLUORIDE	–	2.3	2418
SULPHUR TRIOXIDE, STABILIZED	–	8	1829
SULPHURYL CHLORIDE	–	6.1	1834
SULPHURYL FLUORIDE	–	2.3	2191
Sulprophos, <i>see</i> ORGANOPHOSPHORUS PESTICIDE	P	–	–
Synthetic fabrics, oily, <i>see</i>	–	4.2	1373
Synthetic fibres, oily, <i>see</i>	–	4.2	1373
Systox, <i>see</i> ORGANOPHOSPHORUS PESTICIDE	–	–	–
2,4,5-T, <i>see</i> PHENOXYACETIC ACID DERIVATE PESTICIDE	–	–	–
Tallow nitrile, <i>see</i>	P	9	3082
TARS, LIQUID, including road oils, and cutback bitumens	–	3	1999
Tartar emetic, <i>see</i>	–	6.1	1551
TEAR GAS CANDLES	–	6.1	1700
TEAR GAS SUBSTANCE, LIQUID, N.O.S.	–	6.1	1693
TEAR GAS SUBSTANCE, SOLID, N.O.S.	–	6.1	3448
TELLURIUM COMPOUND, N.O.S.	–	6.1	3284
TELLURIUM HEXAFLUORIDE	–	2.3	2195
Temephos, <i>see</i> ORGANOPHOSPHORUS PESTICIDE	P	–	–
TEPP, <i>see</i> ORGANOPHOSPHORUS PESTICIDE	P	–	–
Terbufos, <i>see</i> ORGANOPHOSPHORUS PESTICIDE	P	–	–
Terbumeton, <i>see</i> TRIAZINE PESTICIDE	–	–	–
TERPENE HYDROCARBONS, N.O.S.	–	3	2319
Terpenes, n.o.s., <i>see</i>	–	3	2319
TERPINOLENE	–	3	2541
TETRABROMOETHANE	P	6.1	2504
1,1,2,2-Tetrabromoethane, <i>see</i>	P	6.1	2504
Tetrabromomethane, <i>see</i>	P	6.1	2516
1,1,2,2-TETRACHLOROETHANE	P	6.1	1702
TETRACHLOROETHYLENE	P	6.1	1897
Tetrachloromethane, <i>see</i>	P	6.1	1846
Tetrachlorophenol, <i>see</i>	–	6.1	2020
Tetrachlorvinphos, <i>see</i> Note 1	P	–	–
Tetraethoxysilane, <i>see</i>	–	3	1292
TETRAETHYL DITHIOPYROPHOSPHATE	P	6.1	1704
TETRAETHYLENEPENTAMINE	–	8	2320
Tetraethyllead, <i>see</i>	P	6.1	1649

Substance, material or article	MP	Class	UN No.
Tetraethyl orthosilicate, see	–	3	1292
TETRAETHYL SILICATE	–	3	1292
Tetrafluorodichloroethane, see	–	2.2	1958
1,1,2,2-Tetrafluoro-1,2-dichloroethane, see	–	2.2	1958
1,1,1,2-TETRAFLUROETHANE	–	2.2	3159
TETRAFLUROETHYLENE, STABILIZED	–	2.1	1081
TETRAFLUOROMETHANE	–	2.2	1982
Tetrafluorosilane, compressed, see	–	2.3	1859
Tetrahydro-1,4-oxazine, see	–	8	2054
1,2,3,6-TETRAHYDROBENZALDEHYDE	–	3	2498
Tetrahydrobenzene, see	–	3	2256
TETRAHYDROFURAN	–	3	2056
TETRAHYDROFURFURYLAMINE	–	3	2943
Tetrahydromethylfuran, see	–	3	2536
TETRAHYDROPHthalic ANHYDRIDES with more than 0.05% maleic anhydride	–	8	2698
1,2,3,6-TETRAHYDROPYRIDINE	–	3	2410
TETRAHYDROTHIOPHENE	–	3	2412
Tetramethoxysilane, see	–	6.1	2606
Tetramethrin, see Note 1	P	–	–
TETRAMETHYLAMMONIUM HYDROXIDE, SOLID	–	8	3423
TETRAMETHYLAMMONIUM HYDROXIDE SOLUTION	–	8	1835
1,1,3,3-Tetramethylbutyl hydroperoxide (concentration ≤100%), see	–	5.2	3105
1,1,3,3-Tetramethylbutyl peroxy-2-ethylhexanoate (concentration ≤100%), see	–	5.2	3115
1,1,3,3-Tetramethylbutyl peroxyneodecanoate (concentration ≤52% as a stable dispersion in water), see	–	5.2	3119
1,1,3,3-Tetramethylbutyl peroxyneodecanoate (concentration ≤72%, with diluent Type B), see	–	5.2	3115
Tetramethylene, see	–	2.1	2601
Tetramethylene cyanide, see	–	6.1	2205
<i>N,N,N',N'</i> -Tetramethylethylenediamine, see	–	3	2372
Tetramethyl lead, see	P	6.1	1649
TETRAMETHYLSILANE	–	3	2749
Tetraminepalladium(II) nitrate (concentration 100%), see	–	4.1	3234
TETRANITROANILINE	–	1.1D	0207
TETRANITROMETHANE	–	6.1	1510
Tetrapropylene, see	–	3	2850
TETRAPROPYL ORTHOTITANATE	–	3	2413
TETRAZENE, WETTED with not less than 30% water, or mixture of alcohol and water, by mass	–	1.1A	0114
TETRAZOL-1-ACETIC ACID	–	1.4C	0407
1 <i>H</i> -TETRAZOLE	–	1.1D	0504
TETRYL	–	1.1D	0208
TEXTILE WASTE, WET	–	4.2	1857

Index

Substance, material or article	MP	Class	UN No.
THALLIUM CHLORATE	P	5.1	2573
Thallium(I) chlorate, <i>see</i>	–	5.1	2573
THALLIUM COMPOUND, N.O.S.	P	6.1	1707
THALLIUM NITRATE	P	6.1	2727
Thallium(I) nitrate, <i>see</i>	–	6.1	2727
Thallium sulphate, <i>see</i>	P	6.1	1707
Thallos chlorate, <i>see</i>	P	5.1	2573
4-THIAPENTANAL	–	6.1	2785
Thia-4-pentanal, <i>see</i>	–	6.1	2785
THIOACETIC ACID	–	3	2436
THIOCARBAMATE PESTICIDE, LIQUID, FLAMMABLE, TOXIC, flashpoint less than 23°C	–	3	2772
THIOCARBAMATE PESTICIDE, LIQUID, TOXIC	–	6.1	3006
THIOCARBAMATE PESTICIDE, LIQUID, TOXIC, FLAMMABLE, flashpoint not less than 23°C	–	6.1	3005
THIOCARBAMATE PESTICIDE, SOLID, TOXIC	–	6.1	2771
Thiocarbonyl chloride, <i>see</i>	–	6.1	2474
Thiocarbonyl tetrachloride, <i>see</i>	P	6.1	1670
THIOGLYCOL	–	6.1	2966
THIOGLYCOLIC ACID	–	8	1940
Thiolacetic acid, <i>see</i>	–	3	2436
THIOLACTIC ACID	–	6.1	2936
Thiometon, <i>see</i> ORGANOPHOSPHORUS PESTICIDE	–	–	–
Thionazin, <i>see</i> ORGANOPHOSPHORUS PESTICIDE	–	–	–
THIONYL CHLORIDE	–	8	1836
THIOPHENE	–	3	2414
Thiophenol, <i>see</i>	–	6.1	2337
THIOPHOSGENE	–	6.1	2474
THIOPHOSPHORYL CHLORIDE	–	8	1837
Thiopropyl alcohols, <i>see</i>	–	3	2402
THIOUREA DIOXIDE	–	4.2	3341
Tin chloride, fuming, <i>see</i>	–	8	1827
Tin(IV) chloride, anhydrous, <i>see</i>	–	8	1827
Tin(IV) chloride pentahydrate, <i>see</i>	–	8	2440
TINCTURES, MEDICINAL	–	3	1293
Tin monophosphide, <i>see</i>	–	4.3	1433
Tin tetrachloride, <i>see</i>	–	8	1827
Titanic chloride, <i>see</i>	–	6.1	1838
TITANIUM DISULPHIDE	–	4.2	3174
TITANIUM HYDRIDE	–	4.1	1871
TITANIUM POWDER, DRY	–	4.2	2546
TITANIUM POWDER, WETTED with not less than 25% water (a visible excess of water must be present) (a) mechanically produced, particle size less than 53 microns	–	4.1	1352

Substance, material or article	MP	Class	UN No.
TITANIUM POWDER, WETTED with not less than 25% water (a visible excess of water must be present) (b) chemically produced, particle size less than 840 microns	–	4.1	1352
TITANIUM SPONGE GRANULES	–	4.1	2878
TITANIUM SPONGE POWDERS	–	4.1	2878
TITANIUM TETRACHLORIDE	–	6.1	1838
TITANIUM TRICHLORIDE MIXTURE	–	8	2869
TITANIUM TRICHLORIDE MIXTURE, PYROPHORIC	–	4.2	2441
TITANIUM TRICHLORIDE, PYROPHORIC	–	4.2	2441
Titanous chloride, pyrophoric, <i>see</i>	–	4.2	2441
TNT AND HEXANITROSTILBENE MIXTURE	–	1.1D	0388
TNT AND TRINITROBENZENE MIXTURE	–	1.1D	0388
TNT dry or wetted with less than 30% water, by mass	–	1.1D	0209
TNT mixed with aluminium, <i>see</i>	–	1.1D	0390
TNT MIXTURE CONTAINING TRINITROBENZENE AND HEXANITROSTILBENE	–	1.1D	0389
TNT, WETTED with not less than 10% water, by mass	–	4.1	3366
TNT, WETTED with not less than 30% water, by mass, <i>see</i>	–	4.1	1356
Toe puffs, nitrocellulose base, <i>see</i>	–	4.1	1353
TOLUENE	–	3	1294
TOLUENE DIISOCYANATE	–	6.1	2078
Toluene trichloride, <i>see</i>	–	8	2226
TOLUIDINES, LIQUID	–	6.1	1708
TOLUIDINES, SOLID	–	6.1	3451
Toluol, <i>see</i>	–	3	1294
2,4-TOLUYLENEDIAMINE, SOLID	–	6.1	1709
2,4-TOLUYLENEDIAMINE SOLUTION	–	6.1	3418
Tolylene diisocyanate, <i>see</i>	–	6.1	2078
Tolylene diisocyanate, <i>see</i>	–	6.1	2078
Tolyethylene, stabilized, <i>see</i>	–	3	2618
TORPEDOES, LIQUID FUELLED with inert head	–	1.3J	0450
TORPEDOES, LIQUID FUELLED with or without bursting charge	–	1.1J	0449
TORPEDOES with bursting charge	–	1.1D	0451
TORPEDOES with bursting charge	–	1.1E	0329
TORPEDOES with bursting charge	–	1.1F	0330
TOXIC BY INHALATION LIQUID, CORROSIVE, N.O.S. with an LC <sub>50</sub> lower than or equal to 200 m <sup>l</sup> /m <sup>3</sup> and saturated vapour concentration greater than or equal to 500 LC <sub>50</sub>	–	6.1	3389
TOXIC BY INHALATION LIQUID, CORROSIVE, N.O.S. with an LC <sub>50</sub> lower than or equal to 1000 m <sup>l</sup> /m <sup>3</sup> and saturated vapour concentration greater than or equal to 10 LC <sub>50</sub>	–	6.1	3390
TOXIC BY INHALATION LIQUID, FLAMMABLE, CORROSIVE, N.O.S. with an LC <sub>50</sub> lower than or equal to 200 m <sup>l</sup> /m <sup>3</sup> and saturated vapour concentration greater than or equal to 500 LC <sub>50</sub>	–	6.1	3488
TOXIC BY INHALATION LIQUID, FLAMMABLE, CORROSIVE, N.O.S. with an LC <sub>50</sub> lower than or equal to 1000 m <sup>l</sup> /m <sup>3</sup> and saturated vapour concentration greater than or equal to 10 LC <sub>50</sub>	–	6.1	3489

Index

Substance, material or article	MP	Class	UN No.
TOXIC BY INHALATION LIQUID, FLAMMABLE, N.O.S. with an LC <sub>50</sub> lower than or equal to 1000 ml/m <sup>3</sup> and saturated vapour concentration greater than or equal to 10 LC <sub>50</sub>	–	6.1	3384
TOXIC BY INHALATION LIQUID, FLAMMABLE, N.O.S. with an LC <sub>50</sub> lower than or equal to 200 ml/m <sup>3</sup> and saturated vapour concentration greater than or equal to 500 LC <sub>50</sub>	–	6.1	3383
TOXIC BY INHALATION LIQUID, N.O.S. with an LC <sub>50</sub> lower than or equal to 1000 ml/m <sup>3</sup> and saturated vapour concentration greater than or equal to 10 LC <sub>50</sub>	–	6.1	3382
TOXIC BY INHALATION LIQUID, N.O.S. with an LC <sub>50</sub> lower than or equal to 200 ml/m <sup>3</sup> and saturated vapour concentration greater than or equal to 500 LC <sub>50</sub>	–	6.1	3381
TOXIC BY INHALATION LIQUID, OXIDIZING, N.O.S. with an LC <sub>50</sub> lower than or equal to 1000 ml/m <sup>3</sup> and saturated vapour concentration greater than or equal to 10 LC <sub>50</sub>	–	6.1	3388
TOXIC BY INHALATION LIQUID, OXIDIZING, N.O.S. with an LC <sub>50</sub> lower than or equal to 200 ml/m <sup>3</sup> and saturated vapour concentration greater than or equal to 500 LC <sub>50</sub>	–	6.1	3387
TOXIC BY INHALATION LIQUID, WATER-REACTIVE, FLAMMABLE, N.O.S. with an LC <sub>50</sub> lower than or equal to 200 ml/m <sup>3</sup> and saturated vapour concentration greater than or equal to 500 LC <sub>50</sub>	–	6.1	3490
TOXIC BY INHALATION LIQUID, WATER-REACTIVE, FLAMMABLE, N.O.S. with an LC <sub>50</sub> lower than or equal to 1000 ml/m <sup>3</sup> and saturated vapour concentration greater than or equal to 10 LC <sub>50</sub>	–	6.1	3491
TOXIC BY INHALATION LIQUID, WATER-REACTIVE, N.O.S. with an LC <sub>50</sub> lower than or equal to 1000 ml/m <sup>3</sup> and saturated vapour concentration greater than or equal to 10 LC <sub>50</sub>	–	6.1	3386
TOXIC BY INHALATION LIQUID, WATER-REACTIVE, N.O.S. with an LC <sub>50</sub> lower than or equal to 200 ml/m <sup>3</sup> and saturated vapour concentration greater than or equal to 500 LC <sub>50</sub>	–	6.1	3385
TOXIC LIQUID, CORROSIVE, INORGANIC, N.O.S.	–	6.1	3289
TOXIC LIQUID, CORROSIVE, ORGANIC, N.O.S.	–	6.1	2927
TOXIC LIQUID, FLAMMABLE, ORGANIC, N.O.S.	–	6.1	2929
TOXIC LIQUID, INORGANIC, N.O.S.	–	6.1	3287
TOXIC LIQUID, ORGANIC, N.O.S.	–	6.1	2810
TOXIC LIQUID, OXIDIZING, N.O.S.	–	6.1	3122
TOXIC LIQUID, WATER-REACTIVE, N.O.S.	–	6.1	3123
TOXIC SOLID, CORROSIVE, INORGANIC, N.O.S.	–	6.1	3290
TOXIC SOLID, CORROSIVE, ORGANIC, N.O.S.	–	6.1	2928
TOXIC SOLID, FLAMMABLE, ORGANIC, N.O.S.	–	6.1	2930
TOXIC SOLID, INORGANIC, N.O.S.	–	6.1	3288
TOXIC SOLID, ORGANIC, N.O.S.	–	6.1	2811
TOXIC SOLID, OXIDIZING, N.O.S.	–	6.1	3086
TOXIC SOLID, SELF-HEATING, N.O.S.	–	6.1	3124
TOXIC SOLID, WATER-REACTIVE, N.O.S.	–	6.1	3125
TOXINS, EXTRACTED FROM LIVING SOURCES, LIQUID, N.O.S.	–	6.1	3172
TOXINS, EXTRACTED FROM LIVING SOURCES, SOLID, N.O.S.	–	6.1	3462
TRACERS FOR AMMUNITION	–	1.3G	0212
TRACERS FOR AMMUNITION	–	1.4G	0306

Substance, material or article	MP	Class	UN No.
Tremolite, <i>see</i>	–	9	2590
Triadimefon, <i>see</i> PHENOXYACETIC ACID DERIVATIVE PESTICIDE	–	–	–
TRIALLYLAMINE	–	3	2610
TRIALLYL BORATE	–	6.1	2609
Triamiphos, <i>see</i> ORGANOPHOSPHORUS PESTICIDE	–	–	–
Triaryl phosphates, isopropylated, <i>see</i>	P	9	3082
Triaryl phosphates, n.o.s., <i>see</i>	P	9	3082
TRIAZINE PESTICIDE, LIQUID, FLAMMABLE, TOXIC, flashpoint less than 23°C	–	3	2764
TRIAZINE PESTICIDE, LIQUID, TOXIC	–	6.1	2998
TRIAZINE PESTICIDE, LIQUID, TOXIC, FLAMMABLE, flashpoint not less than 23°C	–	6.1	2997
TRIAZINE PESTICIDE, SOLID, TOXIC	–	6.1	2763
Triazophos, <i>see</i> ORGANOPHOSPHORUS PESTICIDE	P	–	–
Tribromoborane, <i>see</i>	–	8	2692
Tribromomethane, <i>see</i>	P	6.1	2515
TRIBUTYLAMINE	–	6.1	2542
TRIBUTYLPHOSPHANE	–	4.2	3254
Tributyltin compounds, <i>see</i> ORGANOTIN PESTICIDE	P	–	–
Tricamba, <i>see</i> PESTICIDE, N.O.S.	–	–	–
Trichlorfon, <i>see</i> ORGANOPHOSPHORUS PESTICIDE	P	–	–
Trichloroacetaldehyde, <i>see</i>	–	6.1	2075
TRICHLOROACETIC ACID, SOLID	–	8	1839
TRICHLOROACETIC ACID SOLUTION	–	8	2564
Trichloroacetic aldehyde, anhydrous, stabilized, <i>see</i>	–	6.1	2075
TRICHLOROACETYL CHLORIDE	–	8	2442
1,2,3-Trichlorobenzenes, <i>see</i> Note 1	P	–	–
TRICHLOROBENZENES, LIQUID	P	6.1	2321
TRICHLOROBUTENE	P	6.1	2322
Trichlorobutylene, <i>see</i>	P	6.1	2322
1,1,1-TRICHLOROETHANE	–	6.1	2831
1,1,2-Trichloroethane, <i>see</i>	–	9	3082
TRICHLOROETHYLENE	–	6.1	1710
TRICHLOROISOCYANURIC ACID, DRY	–	5.1	2468
Trichloromethane, <i>see</i>	–	6.1	1888
Trichloromethanesulphuryl chloride, <i>see</i>	P	6.1	1670
Trichloromethyl sulphochloride, <i>see</i>	P	6.1	1670
Trichloronat, <i>see</i> ORGANOPHOSPHORUS PESTICIDE	P	–	–
Trichloronitromethane, <i>see</i>	–	6.1	1580
TRICHLOROSILANE	–	4.3	1295
2,4,6-Trichloro-1,3,5-triazine, <i>see</i>	–	8	2670
1,3,5-Trichloro-s-triazine-2,4,6-trione, <i>see</i>	–	5.1	2468
Tricresyl phosphate, less than 1% <i>ortho</i> -isomer, <i>see</i>	P	9	3082

Index

Substance, material or article	MP	Class	UN No.
Tricresyl phosphate, not less than 1% but not more than 3% <i>ortho</i> -isomer, <i>see</i>	P	9	3082
TRICRESYL PHOSPHATE with more than 3% <i>ortho</i> -isomer	P	6.1	2574
Tricyanogen chloride, <i>see</i>	–	8	2670
Triethoxyboron, <i>see</i>	–	3	1176
Triethoxymethane, <i>see</i>	–	3	2524
TRIETHYLAMINE	–	3	1296
Triethylbenzene, <i>see</i>	P	9	3082
Triethyl borate, <i>see</i>	–	3	1176
Triethylenephosphoramidate solution, <i>see</i>	–	6.1	2501
TRIETHYLENETETRAMINE	–	8	2259
3,6,9-TRIETHYL-3,6,9-TRIMETHYL-1,4,7-TRIPEROXONATE (concentration ≤17%, with diluent Type A, with inert solid)	–	5.2	3110
Triethyl orthoformate, <i>see</i>	–	3	2524
TRIETHYL PHOSPHITE	–	3	2323
3,6,9-Triethyl-3,6,9-trimethyl-1,4,7-triperoxonane (concentration ≤42%, with diluent Type A, available oxygen ≤7.6%), <i>see</i>	–	5.2	3105
TRIFLUOROACETIC ACID	–	8	2699
TRIFLUOROACETYL CHLORIDE	–	2.3	3057
Trifluorobromomethane, <i>see</i>	–	2.2	1009
Trifluorochloroethane, <i>see</i>	–	2.2	1983
TRIFLUOROCHLOROETHYLENE, STABILIZED	–	2.3	1082
Trifluorochloromethane, <i>see</i>	–	2.2	1022
1,1,1-TRIFLUOROETHANE	–	2.1	2035
TRIFLUOROMETHANE	–	2.2	1984
Trifluoromethane and chlorotrifluoromethane azeotropic mixture, <i>see</i> CHLOROTRIFLUOROMETHANE AND TRIFLUOROMETHANE AZEOTROPIC MIXTURE	–	–	–
TRIFLUOROMETHANE, REFRIGERATED LIQUID	–	2.2	3136
Trifluoromethoxytrifluoroethylene, <i>see</i>	–	2.1	3153
2-TRIFLUOROMETHYLANILINE	–	6.1	2942
3-TRIFLUOROMETHYLANILINE	–	6.1	2948
Trifluoromethylbenzene, <i>see</i>	–	3	2338
Trifluoromethylphenyl isocyanates, <i>see</i>	–	6.1	2285
Trifluoromethyl trifluorovinyl ether, <i>see</i>	–	2.1	3153
Trifluoromonochloroethylene, stabilized, <i>see</i>	–	2.3	1082
TRIISOBUTYLENE	–	3	2324
Triisopropylated phenyl phosphates, <i>see</i>	P	9	3077
TRIISOPROPYL BORATE	–	3	2616
TRIMETHYLACETYL CHLORIDE	–	6.1	2438
TRIMETHYLAMINE, ANHYDROUS	–	2.1	1083
TRIMETHYLAMINE, AQUEOUS SOLUTION not more than 50% trimethylamine, by mass	–	3	1297
1,3,5-TRIMETHYLBENZENE	–	3	2325
TRIMETHYL BORATE	–	3	2416

Substance, material or article	MP	Class	UN No.
Trimethyl carbinol, <i>see</i>	–	3	1120
TRIMETHYLCHLOROSILANE	–	3	1298
TRIMETHYLCYCLOHEXYLAMINE	–	8	2326
Trimethylene chlorobromide, <i>see</i>	–	6.1	2688
Trimethylene chlorohydrin, <i>see</i>	–	6.1	2849
Trimethylene dichloride, <i>see</i>	–	3	1993
Trimethylgallium, <i>see</i>	–	4.2	3394
TRIMETHYLHEXAMETHYLENEDIAMINES	–	8	2327
TRIMETHYLHEXAMETHYLENE DIISOCYANATE	–	6.1	2328
2,2,4-Trimethylpentane, <i>see</i>	–	3	1262
2,4,4-Trimethylpentene-1, <i>see</i>	–	3	2050
2,4,4-Trimethylpentene-2, <i>see</i>	–	3	2050
TRIMETHYL PHOSPHITE	–	3	2329
2,4,6-Trimethyl-1,3,5-trioxane, <i>see</i>	–	3	1264
TRINITROANILINE	–	1.1D	0153
TRINITROANISOLE	–	1.1D	0213
TRINITROBENZENE dry or wetted with less than 30% water, by mass	–	1.1D	0214
TRINITROBENZENESULPHONIC ACID	–	1.1D	0386
TRINITROBENZENE, WETTED with not less than 10% water, by mass	–	4.1	3367
TRINITROBENZENE, WETTED with not less than 30% water, by mass	–	4.1	1354
TRINITROBENZOIC ACID dry or wetted with less than 30% water, by mass	–	1.1D	0215
TRINITROBENZOIC ACID, WETTED with not less than 10% water, by mass	–	4.1	3368
TRINITROBENZOIC ACID, WETTED with not less than 30% water, by mass	–	4.1	1355
TRINITROCHLOROBENZENE	–	1.1D	0155
TRINITROCHLOROBENZENE, WETTED with not less than 10% water, by mass	–	4.1	3365
TRINITRO- <i>m</i> -CRESOL	–	1.1D	0216
TRINITROFLUORENONE	–	1.1D	0387
TRINITRONAPHTHALENE	–	1.1D	0217
TRINITROPHENETOLE	–	1.1D	0218
TRINITROPHENOL dry or wetted with less than 30% water, by mass	–	1.1D	0154
TRINITROPHENOL, WETTED with not less than 10% water, by mass	–	4.1	3364
TRINITROPHENOL, WETTED with not less than 30% water, by mass	–	4.1	1344
TRINITROPHENYLMETHYLNITRAMINE	–	1.1D	0208
TRINITRORESORCINOL dry or wetted with less than 20% water, or mixture of alcohol and water, by mass	–	1.1D	0219
TRINITRORESORCINOL, WETTED with not less than 20% water, or mixture of alcohol and water, by mass	–	1.1D	0394
TRINITROTOLUENE AND HEXANITROSTILBENE MIXTURE	–	1.1D	0388
TRINITROTOLUENE AND TRINITROBENZENE MIXTURE	–	1.1D	0388
TRINITROTOLUENE dry or wetted with less than 30% water, by mass	–	1.1D	0209



Index

Substance, material or article	MP	Class	UN No.
TRINITROTOLUENE MIXTURE CONTAINING TRINITROBENZENE AND HEXANITROSTILBENE	–	1.1D	0389
TRINITROTOLUENE, WETTED with not less than 10% water, by mass	–	4.1	3366
TRINITROTOLUENE, WETTED with not less than 30% water, by mass	–	4.1	1356
Trinitrotoluol, wetted with not less than 10% water by mass, see	–	4.1	3366
Trinitrotoluol, wetted with not less than 30% water by mass, see	–	4.1	1356
Triphenyl phosphate, see	P	9	3077
Triphenyl phosphate/ <i>tert</i> -butylated triphenyl phosphates mixtures containing 5% to 10% of triphenyl phosphate, see Note 1	P	–	–
Triphenyl phosphate/ <i>tert</i> -butylated triphenyl phosphates mixtures containing 10% to 48% of triphenyl phosphate, see Note 1	P	–	–
Triphenyltin compounds (other than fentin acetate and fentin hydroxide), see ORGANOTIN PESTICIDE	P	–	–
TRIPROPYLAMINE	–	3	2260
TRIPROPYLENE	–	3	2057
TRIS-(1-AZIRIDINYL)PHOSPHINE OXIDE SOLUTION	–	6.1	2501
Tritolyl phosphate, see	P	6.1	2574
TRITONAL	–	1.1D	0390
Trixylenyl phosphate, see	P	9	3082
Tropilidene, see	–	3	2603
TUNGSTEN HEXAFLUORIDE	–	2.3	2196
TURPENTINE	–	3	1299
TURPENTINE SUBSTITUTE	–	3	1300
UNDECANE	–	3	2330
Uranium hexafluoride, fissile, see	–	7	2977
Uranium hexafluoride, non fissile or fissile – excepted, see	–	7	2978
UREA HYDROGEN PEROXIDE	–	5.1	1511
UREA NITRATE dry or wetted, with less than 20% water, by mass	–	1.1D	0220
UREA NITRATE, WETTED with not less than 10% water, by mass	–	4.1	3370
UREA NITRATE, WETTED with not less than 20% water, by mass	–	4.1	1357
Urotropine, see	–	4.1	1328
Valeral, see	–	3	2058
VALERALDEHYDE	–	3	2058
Valeric aldehyde(s), see	–	3	2058
VALERYL CHLORIDE	–	8	2502
Vamidothion, see ORGANOPHOSPHORUS PESTICIDE	–	–	–
VANADIUM COMPOUND, N.O.S.	–	6.1	3285
Vanadium(IV) oxide sulphate	–	6.1	2931
Vanadium oxysulphate, see	–	6.1	2931
VANADIUM OXYTRICHLORIDE	–	8	2443
VANADIUM PENTOXIDE, non-fused form	–	6.1	2862
VANADIUM TETRACHLORIDE	–	8	2444

Substance, material or article	MP	Class	UN No.
VANADIUM TRICHLORIDE	–	8	2475
VANADYL SULPHATE	–	6.1	2931
Varnish, <i>see</i> PAINT	–	–	–
Vegetable fabrics, oily, <i>see</i>	–	4.2	1373
Vegetable fibres, burnt, <i>see</i>	–	4.2	1372
Vegetable fibres, damp, <i>see</i>	–	4.2	1372
Vegetable fibres, dry, <i>see</i>	–	4.1	3360
Vegetable fibres, oily, <i>see</i>	–	4.2	1373
Vegetable fibres, wet, <i>see</i>	–	4.2	1372
VEHICLE, FLAMMABLE GAS POWERED	–	9	3166
VEHICLE, FLAMMABLE LIQUID POWERED	–	9	3166
VEHICLE, FUEL CELL, FLAMMABLE GAS POWERED	–	9	3166
VEHICLE, FUEL CELL, FLAMMABLE LIQUID POWERED	–	9	3166
VINYL ACETATE, STABILIZED	–	3	1301
Vinylbenzene, stabilized, <i>see</i>	–	3	2055
VINYL BROMIDE, STABILIZED	–	2.1	1085
Vinyl <i>normal</i> -butyl ether, stabilized, <i>see</i>	–	3	2352
VINYL BUTYRATE, STABILIZED	–	3	2838
VINYL CHLORIDE, STABILIZED	–	2.1	1086
VINYL CHLOROACETATE	–	6.1	2589
Vinyl cyanide, stabilized, <i>see</i>	–	3	1093
Vinyl ether, stabilized, <i>see</i>	–	3	1167
VINYL ETHYL ETHER, STABILIZED	–	3	1302
VINYL FLUORIDE, STABILIZED	–	2.1	1860
VINYLDENE CHLORIDE, STABILIZED	P	3	1303
Vinylidene fluoride, <i>see</i>	–	2.1	1959
VINYL ISOBUTYL ETHER, STABILIZED	–	3	1304
VINYL METHYL ETHER, STABILIZED	–	2.1	1087
VINYLPYRIDINES, STABILIZED	–	6.1	3073
VINYLTOLUENES, STABILIZED	–	3	2618
VINYLTRICHLOROSILANE	–	3	1305
Warfarin (and salts of), <i>see</i> COUMARIN DERIVATIVE PESTICIDE	P	–	–
Warheads for guided missiles, <i>see</i> WARHEADS, ROCKET	–	–	–
WARHEADS, ROCKET with burster or expelling charge	–	1.4D	0370
WARHEADS, ROCKET with burster or expelling charge	–	1.4F	0371
WARHEADS, ROCKET with bursting charge	–	1.1D	0286
WARHEADS, ROCKET with bursting charge	–	1.1F	0369
WARHEADS, ROCKET with bursting charge	–	1.2D	0287
WARHEADS, TORPEDO with bursting charge	–	1.1D	0221
Water-activated contrivances, <i>see</i> CONTRIVANCES, WATER-ACTIVATED	–	–	–
Water gels, <i>see</i> EXPLOSIVE, BLASTING, TYPE E	–	–	–

Index

Substance, material or article	MP	Class	UN No.
WATER-REACTIVE LIQUID, CORROSIVE, N.O.S.	–	4.3	3129
WATER-REACTIVE LIQUID, N.O.S.	–	4.3	3148
WATER-REACTIVE LIQUID, TOXIC, N.O.S.	–	4.3	3130
WATER-REACTIVE SOLID, CORROSIVE, N.O.S.	–	4.3	3131
WATER-REACTIVE SOLID, FLAMMABLE, N.O.S.	–	4.3	3132
WATER-REACTIVE SOLID, N.O.S.	–	4.3	2813
WATER-REACTIVE SOLID, OXIDIZING, N.O.S.	–	4.3	3133
WATER-REACTIVE SOLID, SELF-HEATING, N.O.S.	–	4.3	3135
WATER-REACTIVE SOLID, TOXIC, N.O.S.	–	4.3	3134
White arsenic, <i>see</i>	–	6.1	1561
White asbestos, <i>see</i>	–	9	2590
WHITE ASBESTOS (chrysotile, actinolite, anthophyllite, tremolite)	–	9	2590
White phosphorus, dry, <i>see</i>	P	4.2	1381
White phosphorus, wet, <i>see</i>	P	4.2	1381
White spirit, <i>see</i>	P	3	1300
White spirit, low (15–20%) aromatic, <i>see</i>	P	3	1300
WOOD PRESERVATIVES, LIQUID	–	3	1306
Wood tar, <i>see</i>	P	9	3082
WOOL WASTE, WET	–	4.2	1387
XANTHATES	–	4.2	3342
XENON	–	2.2	2036
XENON, REFRIGERATED LIQUID	–	2.2	2591
XYLENES	–	3	1307
XYLENOLS, LIQUID	–	6.1	3430
XYLENOLS, SOLID	–	6.1	2261
XYLIDINES, LIQUID	–	6.1	1711
XYLIDINES, SOLID	–	6.1	3452
Xylols, <i>see</i>	–	3	1307
XYLYL BROMIDE, LIQUID	–	6.1	1701
XYLYL BROMIDE, SOLID	–	6.1	3417
Yellow phosphorus, dry, <i>see</i>	P	4.2	1381
Yellow phosphorus, wet, <i>see</i>	P	4.2	1381
ZINC AMMONIUM NITRITE (transport prohibited)	–	5.1	1512
ZINC ARSENATE	–	6.1	1712
ZINC ARSENATE AND ZINC ARSENITE MIXTURE	–	6.1	1712
ZINC ARSENITE	–	6.1	1712
ZINC ASHES	–	4.3	1435
Zinc bisulphite solution, <i>see</i>	–	8	2693
ZINC BROMATE	–	5.1	2469
Zinc bromide, <i>see</i>	P	9	3077

Substance, material or article	MP	Class	UN No.
ZINC CHLORATE	–	5.1	1513
ZINC CHLORIDE, ANHYDROUS	–	8	2331
ZINC CHLORIDE SOLUTION	–	8	1840
ZINC CYANIDE	P	6.1	1713
ZINC DITHIONITE	–	9	1931
ZINC DUST	–	4.3	1436
Zinc dust, pyrophoric, <i>see</i>	–	4.2	1383
ZINC FLUOROSILICATE	–	6.1	2855
Zinc hexafluorosilicate, <i>see</i>	–	6.1	2855
ZINC HYDROSULPHITE	–	9	1931
ZINC NITRATE	–	5.1	1514
ZINC PERMANGANATE	–	5.1	1515
ZINC PEROXIDE	–	5.1	1516
ZINC PHOSPHIDE	–	4.3	1714
ZINC POWDER	–	4.3	1436
Zinc powder, pyrophoric, <i>see</i>	–	4.2	1383
ZINC RESINATE	–	4.1	2714
Zinc silicofluoride, <i>see</i>	–	6.1	2855
ZIRCONIUM, DRY coiled wire, finished metal sheets, strip (thinner than 254 microns but not thinner than 18 microns)	–	4.1	2858
ZIRCONIUM, DRY finished sheets, strip or coiled wire	–	4.2	2009
ZIRCONIUM HYDRIDE	–	4.1	1437
ZIRCONIUM NITRATE	–	5.1	2728
ZIRCONIUM PICRAMATE dry or wetted with less than 20% water, by mass	–	1.3C	0236
ZIRCONIUM PICRAMATE, WETTED with not less than 20% water, by mass	–	4.1	1517
ZIRCONIUM POWDER, DRY	–	4.2	2008
ZIRCONIUM POWDER, WETTED with not less than 25% water (a visible excess of water must be present) (a) mechanically produced, particle size less than 53 microns	–	4.1	1358
ZIRCONIUM POWDER, WETTED with not less than 25% water (a visible excess of water must be present) (b) chemically produced, particle size less than 840 microns	–	4.1	1358
ZIRCONIUM, SCRAP	–	4.2	1932
ZIRCONIUM, SUSPENDED IN A FLAMMABLE LIQUID	–	3	1308
ZIRCONIUM TETRACHLORIDE	–	8	2503

RESOLUTION MSC.372(93)  
(adopted on 22 May 2014)  
AMENDMENTS TO THE INTERNATIONAL MARITIME  
DANGEROUS GOODS (IMDG) CODE

**TSFS 2015:66**  
**Bilaga 2**

---

**ANNEX 8**

**RESOLUTION MSC.372(93)  
(adopted on 22 May 2014)**

**AMENDMENTS TO THE INTERNATIONAL MARITIME  
DANGEROUS GOODS (IMDG) CODE**

THE MARITIME SAFETY COMMITTEE,

RECALLING Article 28(b) of the Convention on the International Maritime Organization concerning the functions of the Committee,

NOTING resolution MSC.122(75) by which it adopted the International Maritime Dangerous Goods Code (hereinafter referred to as "the IMDG Code"), which has become mandatory under chapter VII of the International Convention for the Safety of Life at Sea (SOLAS), 1974, as amended (hereinafter referred to as "the Convention"),

NOTING ALSO article VIII(b) and regulation VII/1.1 of the Convention concerning amendment procedure for amending the IMDG Code,

HAVING CONSIDERED, at its ninety-third session, amendments to the IMDG Code, proposed and circulated in accordance with article VIII(b)(i) of the Convention,

1 ADOPTS, in accordance with article VIII(b)(iv) of the Convention, amendments to the IMDG Code, the text of which is set out in the annex to the present resolution;

2 DETERMINES, in accordance with article VIII(b)(vi)(2)(bb) of the Convention, that the said amendments shall be deemed to have been accepted on 1 July 2015, unless prior to that date, more than one third of the Contracting Governments to the Convention or Contracting Governments the combined merchant fleets of which constitute not less than 50% of the gross tonnage of the world's merchant fleet, have notified their objections to the amendments;

3 INVITES Contracting Governments to the Convention to note that, in accordance with article VIII(b)(vii)(2) of the Convention, the amendments shall enter into force on 1 January 2016 upon their acceptance in accordance with paragraph 2 above;

4 AGREES that Contracting Governments to the Convention may apply the aforementioned amendments in whole or in part on a voluntary basis as from 1 January 2015;

5 REQUESTS the Secretary-General, in conformity with article VIII(b)(v) of the Convention, to transmit certified copies of the present resolution and the text of the amendments contained in the annex to all Contracting Governments to the Convention;

6 ALSO REQUESTS the Secretary-General to transmit copies of this resolution and its annex to Members of the Organization, which are not Contracting Governments to the Convention.

ANNEX

**AMENDMENTS TO THE INTERNATIONAL MARITIME  
DANGEROUS GOODS (IMDG) CODE**

**Table of Contents**

Insert a new section as "7.1.5 Stowage Codes".

Insert a new section as "7.1.6 Handling Codes".

Insert a new section as "7.2.8 Segregation Codes".

**PART 1  
GENERAL PROVISIONS, DEFINITIONS AND TRAINING**

**Chapter 1.1– General provisions**

**1.1.1 Application and implementation of the Code**

1.1.1.9 Insert a new paragraph 1.1.1.9 to read as follows:

**"1.1.1.9 *Lamps containing dangerous goods***

The following lamps are not subject to this Code provided that they do not contain radioactive material and do not contain mercury in quantities above those specified in special provision 366 of chapter 3.3:

- .1 Lamps that are collected directly from individuals and households when transported to a collection or recycling facility;
- .2 Lamps each containing not more than 1 g of dangerous goods and packaged so that there is not more than 30 g of dangerous goods per package, provided that:
  - (i) the lamps are manufactured according to a certified quality management system;

Note: The application of ISO 9001:2008 may be considered acceptable for this purpose.

and

- (ii) each lamp is either individually packed in inner packagings, separated by dividers, or surrounded with cushioning material to protect the lamps and packed into strong outer packagings meeting the general provisions of 4.1.1.1 and capable of passing a 1.2 m drop test.

- .3 Used, damaged or defective lamps each containing not more than 1 g of dangerous goods with not more than 30 g of dangerous goods per package when transported from a collection or recycling facility. The lamps shall be packed in strong outer packagings sufficient for preventing release of the contents under normal conditions of transport meeting the general provisions of 4.1.1.1 and that are capable of passing a drop test of not less than 1.2 m.

Note: lamps containing gases of class 2.2. are addressed in 2.2.2.6.4 and lamps containing radioactive material are addressed in 2.7.2.2.2.2.

- .4 Lamps containing only gases of class 2.2 (according to 2.2.2.2) provided they are packaged so that the projectile effects of any rupture of the bulb will be contained within the package."

## 1.1.2 Conventions

### 1.1.2.3 International Convention for Safe Containers, 1972, as amended

1.1.2.3 Insert a new 1.1.2.3 with the following:

#### "1.1.2.3 International Convention for Safe Containers, 1972, as amended

- 1.1.2.3.1 Regulations 1 and 2 of Annex I to the International Convention for Safe Containers (CSC), 1972, as amended, deal with safety approval plates and maintenance and examination of containers, and are reproduced in full.

### **Annex I** **Regulations for the testing, inspection, approval and maintenance of containers**

#### **Chapter I** *Regulations common to all systems of approval*

#### **Regulation 1** *Safety Approval Plate*

- 1 (a) A Safety Approval Plate conforming to the specifications set out in the appendix to this annex shall be permanently affixed to every approved container at a readily visible place, adjacent to any other approval plate issued for official purposes, where it would not be easily damaged.
- (b) On each container, all maximum operating gross mass markings shall be consistent with the maximum operating gross mass information on the Safety Approval Plate.
- (c) The owner of the container shall remove the Safety Approval Plate on the container if:



- (i) the container has been modified in a manner which would void the original approval and the information found on the Safety Approval Plate, or
- (ii) the container is removed from service and is not being maintained in accordance with the Convention, or
- (iii) the approval has been withdrawn by the Administration.
- 2 (a) The plate shall contain the following information in at least the English or French language:
- CSC SAFETY APPROVAL**
- Country of approval and approval reference
- Date (month and year) of manufacture
- Manufacturer's identification number of the container or, in the case of existing containers for which that number is unknown, the number allotted by the Administration
- Maximum operating gross mass (kg and lb)
- Allowable stacking load for 1.8g (kg and lb)
- Transverse racking test force (newtons).
- (b) A blank space should be reserved on the plate for insertion of end-wall and/or side-wall strength values (factors) in accordance with paragraph 3 of this regulation and annex II, tests 6 and 7. A blank space should also be reserved on the plate for the first and subsequent maintenance examination dates (month and year) when used.
- 3 Where the Administration considers that a new container satisfies the requirements of the present Convention in respect of safety and if, for such container, the end-wall and/or side-wall strength values (factors) are designed to be greater or less than those stipulated in annex II, such values shall be indicated on the Safety Approval Plate. Where the stacking or racking values are less than 192,000 kg or 150 kN, respectively, the container shall be considered as having limited stacking or racking capacity and shall be conspicuously marked, as required under the relevant standards\*, at or before their next scheduled examination or before any other date approved by the Administration, provided this is not later than 1 July 2015.

- 4 The presence of the Safety Approval Plate does not remove the necessity of displaying such labels or other information as may be required by other regulations which may be in force.
- 5 A container, the construction of which was completed prior to 1 July 2014, may retain the Safety Approval Plate as permitted by the Convention prior to that date as long as no structural modifications occur to that container.

## **Regulation 2**

### *Maintenance and examination*

- 1 The owner of the container shall be responsible for maintaining it in safe condition.
- 2
  - (a) The owner of an approved container shall examine the container or have it examined in accordance with the procedure either prescribed or approved by the Contracting Party concerned, at intervals appropriate to operating conditions.
  - (b) The date (month and year) before which a new container shall undergo its first examination shall be marked on the Safety Approval Plate.
  - (c) The date (month and year) before which the container shall be re-examined shall be clearly marked on the container on or as close as practicable to the Safety Approval Plate and in a manner acceptable to that Contracting Party which prescribed or approved the particular examination procedure involved.
  - (d) The interval from the date of manufacture to the date of the first examination shall not exceed five years. Subsequent examination of new containers and re-examination of existing containers shall be at intervals of not more than 30 months. All examinations shall determine whether the container has any defects which could place any person in danger.
- 3
  - (a) As an alternative to paragraph 2, the Contracting Party concerned may approve a continuous examination programme if satisfied, on evidence submitted by the owner, that such a programme provides a standard of safety not inferior to the one set out in paragraph 2 above.
  - (b) To indicate that the container is operated under an approved continuous examination programme, a mark showing the letters ACEP and the identification of the Contracting Party which has granted approval of the programme shall be displayed on the container on or as close as practicable to the Safety Approval Plate.
  - (c) All examinations performed under such a programme shall determine whether a container has any defects

which could place any person in danger. They shall be performed in connection with a major repair, refurbishment, or on-hire/off-hire interchange and in no case less than once every 30 months.

- 4 As a minimum approved programmes should be reviewed once every 10 years to ensure their continued viability. In order to ensure uniformity by all involved in the inspection of containers and their ongoing operational safety, the Contracting Party concerned shall ensure the following elements are covered in each prescribed periodic or approved continuous examination programme:
- (a) methods, scope and criteria to be used during examinations;
  - (b) frequency of examinations;
  - (c) qualifications of personnel to carry out examinations;
  - (d) system of keeping records and documents that will capture:
    - (i) the owner's unique serial number of the container;
    - (ii) the date on which the examination was carried out;
    - (iii) identification of the competent person who carried out the examination;
    - (iv) the name and location of the organization where the examination was carried out;
    - (v) the results of the examination; and
    - (vi) in the case of a periodic examination scheme (PES), the next examination date (NED);
  - (e) a system for recording and updating the identification numbers of all containers covered by the appropriate examination scheme;
  - (f) methods and systems for maintenance criteria that addresses the design characteristics of the specific containers;
  - (g) provisions for maintaining leased containers if different than those used for owned containers; and
  - (h) conditions and procedures for adding containers into an already approved programme.

- 5 The Contracting Party shall carry out periodic audits of approved programmes to ensure compliance with the provisions approved by the Contracting Party. The Contracting Party shall withdraw any approval when the conditions of approval are no longer complied with.
- 6 For the purpose of this regulation, the Contracting Party concerned is the Contracting Party of the territory in which the owner is domiciled or has his head office. However, in the event that the owner is domiciled or has his head office in a country the government of which has not yet made arrangements for prescribing or approving an examination scheme and until such time as the arrangements have been made, the owner may use the procedure prescribed or approved by the Administration of a Contracting Party which is prepared to act as the Contracting Party concerned. The owner shall comply with the conditions for the use of such procedures set by the Administration in question.
- 7 Administrations shall make information on approved continuous examination programmes publicly available."

## Chapter 1.2 – Definitions, units of measurement and abbreviations

### 1.2.1 Definitions

In all the definitions, whenever the term "for the transport of Class 7 material" is used, replace it with "for the transport of radioactive material".

Amend the following definitions as indicated:

*Design:* in the first sentence, insert "fissile material excepted under 2.7.3.5.6 after "the description of".

*Exclusive use:* replace "and unloading is carried" with "and unloading and shipment are carried" and insert ", where so required by the provisions of this Code;" after "consignee".

*Freight container:* replace the last two sentences with the following:

"In addition: Small freight container means a freight container that has an internal volume of not more than 3 m<sup>3</sup>. Large freight container means a freight container that has an internal volume of more than 3 m<sup>3</sup>".

*GHS:* in the reference for GHS, replace Rev.4 with "Rev.5"

*Manual of Test and Criteria,* add at the end "and Amend.2".

*Multiple-element gas container:* replace "and bundles" with "or bundles".

*Radiation level:* amend the end of the definition to read: "millisieverts per hour or microsieverts per hour;".

Add the following new definitions in alphabetical order:

"*Large salvage packaging* means a special packaging which:

- .1 is designed for mechanical handling; and
- .2 exceeds 400 kg net mass or 450 litres capacity but has a volume of not more than 3 m<sup>3</sup>;

into which damaged, defective or leaking dangerous goods packages, or dangerous goods that have spilled or leaked are placed for purposes of transport for recovery or disposal;"

"*Management system*, for the transport of radioactive material, means a set of interrelated or interacting elements (system) for establishing policies and objectives and enabling the objectives to be achieved in an efficient and effective manner;"

"*Neutron radiation detector* is a device that detects neutron radiation. In such a device, a gas may be contained in a hermetically sealed electron tube transducer that converts neutron radiation into a measureable electric signal;"

"*Radiation detection system* is an apparatus that contains radiation detectors as components;"

## Chapter 1.5 – General provisions concerning class 7

Replace the title with "GENERAL PROVISIONS CONCERNING RADIOACTIVE MATERIAL".

### 1.5.1 Scope and application

1.5.1.1 Amend the second and third sentences to read:

"These provisions are based on the IAEA "Regulations for the Safe Transport of Radioactive material, 2012 Edition, IAEA Safety Standards Series No. SSR-6, IAEA, Vienna (2012)". Explanatory material can be found in "Advisory material for the IAEA Regulations for the Safe Transport of Radioactive Material, IAEA Safety Standards Series No. TS-G-1.1 (Rev.2), IAEA, Vienna (2012)"."

1.5.1.2 In the second sentence of the last paragraph replace "imposing requirements" with "imposing conditions".

1.5.1.4 Amend the first sentence to read: "The provisions of this code do not apply to any of the following:" and insert a new subparagraph .4 to read as follows:

- ".4 Radioactive material in or on a person who is to be transported for medical treatment because the person has been subject to accidental or deliberate intake of radioactive material or to contamination;"

and renumber current subparagraphs .4 to .6 accordingly:

and replace new subparagraph .6 (former .5) with the following:

- ".6 Natural material and ores containing naturally occurring radionuclides (which may have been processed), provided the activity concentration of the material does not exceed 10 times the values specified in table 2.7.2.2.1, or calculated in accordance with 2.7.2.2.1 and 2.7.2.2.3 to 2.7.2.2.6. For natural materials and ores containing naturally occurring radionuclides that are not in secular equilibrium the calculation of the activity concentration shall be performed in accordance with 2.7.2.2.4;"

### 1.5.1.5 Specific provisions for the transport of excepted packages

1.5.1.5.1 Amend to read as follows:

"1.5.1.5.1 Excepted packages which may contain radioactive material in limited quantities, instruments, manufactured articles or empty packagings as specified in 2.7.2.4.1 shall be subject only to the following provisions of parts 5 to 7:

- .1 The applicable provisions specified in 5.1.1.2, 5.1.2, 5.1.3.2, 5.1.5.2.2, 5.1.5.4, 5.2.1.7, 7.1.4.5.9, 7.1.4.5.10, 7.1.4.5.12, 7.8.4.1 to 7.8.4.6 and 7.8.9.1; and
- .2 The requirements for excepted packages specified in 6.4.4,

except when the radioactive material possesses other hazardous properties and has to be classified in a class other than Class 7 in accordance with special provision 290 or 369 of Chapter 3.3, where the provisions listed in .1 and .2 above apply only as relevant and in addition to those relating to the main class or division."

1.5.1.5.2 Insert a new second sentence to read as follows:

"If the excepted package contains fissile material, one of the fissile exceptions provided by 2.7.2.3.5 shall apply and the requirements of 5.1.5.5 shall be met."

### 1.5.2 Radiation protection programme

1.5.2.4 Amend the end of the introductory sentence to read "that the effective dose either:" and insert "or" at the end of subparagraph .1.

### 1.5.3 Quality assurance

1.5.3 Amend to read as follows:

"1.5.3 Management system

1.5.3.1 A management system based on international, national or other standards acceptable to the competent authority shall be established and implemented for all activities within the scope of this Code, as identified in 1.5.1.3, to ensure compliance with the relevant provisions of this Code. Certification that the design specification has been fully implemented shall be available to the competent authority. The manufacturer, consignor or user shall be prepared:

- .1 to provide facilities for inspection during manufacture and use; and
- .2 to demonstrate compliance with this Code to the competent authority.

Where competent authority approval is required, such approval shall take into account and be contingent upon the adequacy of the management system."

### 1.5.4 Special arrangement

1.5.4.2 Replace "Class 7" with "radioactive material", twice.

### 1.5.6 Non-compliance

1.5.6.1 In the introductory sentence, delete "a" before "non-compliance". In .1 amend the introductory sentence to read:

"The consignor, consignee, carrier and any organization involved during transport who may be affected, as appropriate, shall be informed of the non-compliance:"

and in .2(iv), delete "and" at the end of the sentence.

## PART 2 CLASSIFICATION

### Chapter 2.0 – Introduction

#### 2.0.1 Classes, divisions, packing groups

##### 2.0.1.2 Marine pollutants

2.0.1.2.1 Amend paragraph 2.0.1.2.1 to read as follows:

"Many of the substances assigned to classes 1 to 6.2, 8 and 9 are deemed as being *marine pollutants* (see chapter 2.10)."

2.0.1.3 Add the following new paragraph at the end:

"Articles are not assigned to packing groups. For packing purposes any requirement for a specific packaging performance level is set out in the applicable packing instruction."

#### 2.0.3 Classification of substances, mixtures and solutions with multiple hazards (precedence of hazard characteristics)

2.0.3.5 Amend the last sentence to read as follows:

"For radioactive material in excepted packages, except for UN 3507, URANIUM HEXAFLUORIDE, RADIOACTIVE MATERIAL, EXCEPTED PACKAGE, special provision 290 of Chapter 3.3 applies."

### Chapter 2.1 – Class 1 – Explosives

#### 2.1.0 Introductory notes (these notes are not mandatory)

Amend Note 2 in 2.1.3.5.5 to read as follows:

**Note 2:** "Flash composition" in this table refers to pyrotechnic substances in powder form or as pyrotechnic units as presented in the firework that are used to produce an aural effect or used as a bursting charge, or propellant charge unless the time taken for the pressure rise is demonstrated to be more than 6 ms for 0.5 g of pyrotechnic substance in the HSL Flash Composition Test in appendix 7 of the Manual of Tests and Criteria."

## Chapter 2. 2 – Class 2 – Gases

### 2.2.1 Definitions and general provisions

2.2.1.2 Add a new indent .5 to read as follows:

".5 *Adsorbed gas* – a gas which when packaged for transport is adsorbed onto a solid porous material resulting in an internal receptacle pressure of less than 101.3 kPa at 20°C and less than 300 kPa at 50°C."

### 2.2.2 Class subdivisions

2.2.2.6 Delete subparagraph ".4" and add the following note at the end:

"Note: This exemption does not apply to lamps. For lamps see 1.1.1.9".

## Chapter 2.3 – Class 3 – Flammable liquids

### 2.3.2 Assignment of packing group

2.3.2.2 and 2.3.2.3 Replace existing paragraphs with the following:

"2.3.2.2 Viscous flammable liquids such as paints, enamels, lacquers, varnishes, adhesives and polishes having a flash point of less than 23°C may be placed in packing group III in conformity with the procedures prescribed in the Manual of Tests and Criteria, Part III, sub-section 32.3, provided that:

.1 The viscosity expressed as the flowtime in seconds and flash point are in accordance with the following table:

<i>Flow-time t in seconds</i>	<i>Jet diameter (mm)</i>	<i>Flash point, closed-cup (°C)</i>
20 < t ≤ 60	4	above 17
60 < t ≤ 100	4	above 10
20 < t ≤ 32	6	above 5
32 < t ≤ 44	6	above -1
44 < t ≤ 100	6	above -5
100 < t	6	no limit

.2 Less than 3% of the clear solvent layer separates in the solvent separation test;

.3 The mixture or any separated solvent does not meet the criteria for Class 6.1 or Class 8;

.4 The substances are packed in receptacles of not more than 30-litre capacity.

2.3.2.3 *Reserved.*"

2.3.2.5 At the beginning, replace "Viscous substances" with "Viscous liquids". Amend the fourth indent to read as follows:

"- are packed in receptacles of not more than 30-litre capacity".



**Chapter 2.4 – Class 4 – Flammable solids; substances liable to spontaneous combustion; substances which, in contact with water, emit flammable gases**

**2.4.4 Class 4.3 – Substances which, in contact with water, emit flammable gases**

**2.4.4.1 Definitions and properties**

2.4.4.1.2 Replace "light bulbs" with "lamps"

**Chapter 2.5 – Class 5 – Oxidizing substances and organic peroxides**

**2.5.1 Definitions and general provisions**

**2.5.2 Class 5.1 – Oxidizing substances**

2.5.2.2 Oxidizing solids

2.5.2.2.1 *Classification of solid substances of class 5.1*

2.5.2.2.1.1 Amend to read as follows:

"2.5.2.2.1.1 Tests are performed to measure the potential for the solid substance to increase the burning rate or burning intensity of a combustible substance when the two are thoroughly mixed. The procedure is given in the Manual of Tests and Criteria, part III, sub-section 34.4.1 (test O.1) or alternatively, in sub-section 34.4.3 (test O.3). Tests are conducted on the substance to be evaluated mixed with dry fibrous cellulose in mixing ratios of 1:1 and 4:1, by mass, of sample to cellulose. The burning characteristics of the mixtures are compared:

- .1 in the test O.1, with the standard 3:7 mixture, by mass, of potassium bromate to cellulose. If the burning time is equal to or less than this standard mixture, the burning times shall be compared with those from the packing group I or II reference standards, 3:2 and 2:3 ratios, by mass, of potassium bromate to cellulose respectively; or
- .2 in the test O.3, with the standard 1:2 mixture, by mass, of calcium peroxide to cellulose. If the burning rate is equal to or greater than this standard mixture, the burning rates shall be compared with those from the packing group I or II reference standards 3:1 and 1:1 ratios, by mass, of calcium peroxide to cellulose, respectively."

2.5.2.2.1.2 Amend to read as follows:

"2.5.2.2.1.2 The classification test results are assessed on the basis of:

- .1 the comparison of the mean burning time (for the test O.1) or burning rate (for the test O.3) with those of the reference mixtures; and

- .2 whether the mixture of substance and cellulose ignites and burns."

2.5.2.2.1.3 Amend to read as follows:

"2.5.2.2.1.3 A solid substance is classified in Class 5.1 if the 4:1 or 1:1 sample-to-cellulose ratio (by mass) tested, exhibits:

- .1 in the test O.1, a mean burning time equal to or less than the mean burning time of a 3:7 mixture (by mass) of potassium bromate and cellulose ; or
- .2 in the test O.3, a mean burning rate equal to or greater than the mean burning rate of a 1:2 mixture (by mass) of calcium peroxide and cellulose."

2.5.2.2.2 *Assignment of packing groups*

2.5.2.2.2 Amend to read as follows:

"2.5.2.2.2 Assignment of packing groups

Solid oxidizing substances are assigned to a packing group according to one of the test procedures in the Manual of Tests and Criteria, Part III, sub-section 34.4.1 (test O.1) or sub-section 34.4.3 (test O.3), in accordance with the following criteria:

- .1 Test O.1:
  - (i) Packing group I: any substance which, in the 4:1 or 1:1 sample-to-cellulose ratio (by mass) tested, exhibits a mean burning time less than the mean burning time of a 3:2 mixture, by mass, of potassium bromate and cellulose;
  - (ii) Packing group II: any substance which, in the 4:1 or 1:1 sample-to-cellulose ratio (by mass) tested, exhibits a mean burning time equal to or less than the mean burning time of a 2:3 mixture (by mass) of potassium bromate and cellulose, and the criteria for packing group I are not met;
  - (iii) Packing group III: any substance which, in the 4:1 or 1:1 sample-to-cellulose ratio (by mass) tested, exhibits a mean burning time equal to or less than the mean burning time of a 3:7 mixture (by mass) of potassium bromate and cellulose , and the criteria for packing groups I and II are not met;
  - (iv) Not Class 5.1: any substance which, in both the 4:1 and 1:1 sample-to-cellulose ratio (by mass) tested, does not ignite and burn, or exhibits mean burning times greater than that of a 3:7 mixture (by mass) of potassium bromate and cellulose.

.2 Test O.3:

- (i) Packing group I: any substance which, in the 4:1 or 1:1 sample-to-cellulose ratio (by mass) tested, exhibits a mean burning rate greater than the mean burning rate of a 3:1 mixture (by mass) of calcium peroxide and cellulose;
- (ii) Packing group II: any substance which, in the 4:1 or 1:1 sample-to-cellulose ratio (by mass) tested, exhibits a mean burning rate equal to or greater than the mean burning rate of a 1:1 mixture (by mass) of calcium peroxide and cellulose, and the criteria for packing group I are not met;
- (iii) Packing group III: any substance which, in the 4:1 or 1:1 sample-to-cellulose ratio (by mass) tested, exhibits a mean burning rate equal to or greater than the mean burning rate of a 1:2 mixture (by mass) of calcium peroxide and cellulose, and the criteria for packing groups I and II are not met;
- (iv) Not Class 5.1: any substance which, in both the 4:1 and 1:1 sample-to-cellulose ratio (by mass) tested, does not ignite and burn, or exhibits a mean burning rate less than the mean burning rate of a 1:2 mixture (by mass) of calcium peroxide and cellulose."

2.5.2.3.1.1 At the end of the second sentence after "3.4.4.2" insert "(test O.2)".

## Chapter 2.6 – Class 6 – Toxic and infectious substances

### 2.6.3 Class 6.2 – Infectious substances

#### 2.6.3.2.3 Exemptions

2.6.3.2.3.5 Amend to read as follows:

"2.6.3.2.3.5 Dried blood spots, collected by applying a drop of blood onto absorbent material, are not subject to the provisions of this Code."

and insert two new paragraphs 2.6.3.2.3.6 and 2.6.3.2.3.7 to read as follows and renumber existing paragraphs accordingly:

"2.6.3.2.3.6 Faecal occult blood screening samples are not subject to the provisions of this Code.

2.6.3.2.3.7 Blood or blood components which have been collected for the purposes of transfusion or for the preparation of blood products to be used for transfusion or transplantation and any tissues or organs intended for use in transplantation as well as samples drawn in connection with such purposes are not subject to the provisions of this Code."

## Chapter 2.7 – Class 7 – Radioactive material

### 2.7.1.3 Definitions of specific terms

2.7.1.3 Amend the definitions hereafter as follows:

*Fissile nuclides:* Amend the end of the introductory text before subparagraph .1 to read: "of fissile material are the following:".

In subparagraph .1, delete "and".

Insert the following new subparagraphs and text:

- .3 material with fissile nuclides less than a total of 0.25 g;
- .4 any combination of .1, .2 and/or .3.

These exclusions are only valid if there is no other material with fissile nuclides in the package or in the consignment if shipped unpackaged."

*Surface contaminated object:* at the end, replace "surfaces" with "surface".

### 2.7.2 Classification

#### 2.7.2.1 General provisions

2.7.2.1.1 Amend to read as follows:

"Radioactive material shall be assigned to one of the UN numbers specified in table 2.7.2.1.1, in accordance with 2.7.2.4.2 to 2.7.2.5, taking into account the material characteristics determined in 2.7.2.3."

**Table 2.7.2.1.1 – Assignment of UN Numbers**

2.7.2.1.1 Amend the table as follows:

Table 2.7.2.1.1 Add a new heading row to read:

UN Nos.	Proper shipping name and description
---------	--------------------------------------

For UN Nos. 2912, 3321, 3322, 2913, 2915, 3332, 2916, 2917, 3323, 2919 and 2978, insert a reference to a new note "b" after "fissile-excepted".

Under the headings "Excepted packages" and "Uranium hexafluoride" add the following new entry:

"UN 3507 URANIUM HEXAFLUORIDE, RADIOACTIVE MATERIAL, EXCEPTED PACKAGE less than 0.1 kg per package, non-fissile or fissile-excepted<sup>b,c"</sup>

Add the following table notes "a", "b" and "c" after the table:

<sup>a</sup> *The proper shipping name is found in the column "proper shipping name and description" and is restricted to that part shown in capital letters. In the*

*cases of UN Nos. 2909, 2911, 2913 and 3326, where alternative proper shipping names are separated by the word "or" only the relevant proper shipping name shall be used.*

<sup>b</sup> *The term "fissile-excepted" refers only to material excepted under 2.7.2.3.5.*

<sup>c</sup> *For UN No. 3507, see also special provision 369 in Chapter 3.3."*

## **2.7.2.2 Determination of activity level**

2.7.2.2.1 In .2, insert "limits" after "concentration".

Table 2.7.2.2.1 In the heading of column 4 insert "limit" after "concentration". In (a) after the table, in the introductory sentence, replace "from daughter radionuclides" with "from their progeny".

2.7.2.2.2 Amend the text before the table to read as follows:

"2.7.2.2.2 For individual radionuclides:

- .1 Which are not listed in table 2.7.2.2.1 the determination of the basic radionuclide values referred to in 2.7.2.2.1 shall require multilateral approval. For these radionuclides, activity concentration limits for exempt material and activity limits for exempt consignments shall be calculated in accordance with the principles established in the International Basic Safety Standards for Protection against Ionizing Radiation and for the Safety of Radiation Sources, Safety Series No.115, IAEA, Vienna (1996). It is permissible to use an  $A_2$  value calculated using a dose coefficient for the appropriate lung absorption type as recommended by the International Commission on Radiological Protection, if the chemical forms of each radionuclide under both normal and accident conditions of transport are taken into consideration. Alternatively, the radionuclide values in table 2.7.2.2.2 may be used without obtaining competent authority approval;
- .2 In instruments or articles in which the radioactive material is enclosed or is included as a component part of the instrument or other manufactured article and which meet 2.7.2.4.1.3.3, alternative basic radionuclide values to those in table 2.7.2.2.1 for the activity limit for an exempt consignment are permitted and shall require multilateral approval. Such alternative activity limits for an exempt consignment shall be calculated in accordance with the principles set out in the International Basic Safety Standards for Protection against Ionizing Radiation and for the Safety of Radiation Sources, Safety Series No.115, IAEA, Vienna (1996)."

### **Table 2.7.2.2.2 – Basic radionuclide values for unknown radionuclides or mixtures**

In the table for 2.7.2.2.2, in the heading of the fourth column, insert "limit" after "concentration".

2.7.2.2.4 In the introductory sentence delete "the determination of" and in the legend for X(i) and X<sub>m</sub> replace "concentration" with "concentration limit".

### 2.7.2.3 Determination of other material characteristics

#### 2.7.2.3.1 *Low specific activity (LSA) material*

2.7.2.3.1.2.1 In subparagraph "(i)", delete "which are intended to be processed for the use of these radionuclides".

2.7.2.3.1.2.1 Subparagraph "(iii)" to read:

"(iii) radioactive material for which the A2 value is unlimited. Fissile material may be included only if excepted under 2.7.2.3.5;"

2.7.2.3.1.2.1 (iv), replace ", excluding fissile material not excepted under 2.7.2.3.5" with ". Fissile material may be included only if excepted under 2.7.2.3.5".

2.7.2.3.1.2.2 In subparagraph "(i)", delete "or".

2.7.2.3.1.2.3 In the introductory sentence, replace "meeting the requirements" with "that meet the requirements".

2.7.2.3.1.2.3 In subparagraph "(i)" replace "bitumen, ceramic, etc." with "bitumen and ceramic".

#### 2.7.2.3.2 *Surface contaminated object (SCO)*

2.7.2.3.2.1 At the end of subparagraph "(ii)", replace "and" with "or".

2.7.2.3.2.2 At the end of subparagraph "(ii)", replace "and" with "or".

#### 2.7.2.3.3 *Special form radioactive material*

2.7.2.3.3.6.1 Amend subparagraph ".1" to read as follows:

".1 The tests prescribed in 2.7.2.3.3.5.1 and 2.7.2.3.3.5.2 provided that the specimens are alternatively subjected to the impact test prescribed in ISO 2919:2012: "Radiation Protection – Sealed Radioactive Sources – General requirements and classification":

(i) The Class 4 impact test if the mass of the special form radioactive material is less than 200 g; and

(ii) The Class 5 impact test if the mass of the special form radioactive material is equal to or more than 200 g but less than 500 g;"

2.7.2.3.3.6.2 Replace the reference "ISO 2919:1999" with "ISO 2919:2012".

2.7.2.3.3.8.2 Replace "which are acceptable" with "provided that they are acceptable".

## 2.7.2.3 Determination of other material characteristics

### 2.7.2.3.5 Fissile material

2.7.2.3.5 Amend the first paragraph to read as follows:

"Fissile material and packages containing fissile material shall be classified under the relevant entry as "FISSILE" in accordance with table 2.7.2.1.1 unless excepted by one of the provisions of subparagraphs .1 to .6 below and transported subject to the requirements of 5.1.5.5. All provisions apply only to material in packages that meets the requirements of 6.4.7.2 unless unpackaged material is specifically allowed in the provision."

#### 2.7.2.3.5 *Fissile material*

2.7.2.3.5 Delete current subparagraphs ".1" and ".4". Current ".2" and ".3" are renumbered as ".1" and ".2" respectively.

2.7.2.3.5 Insert the following new subparagraphs ".3 to .6":

- .3 Uranium with a maximum uranium enrichment of 5% by mass uranium-235 provided:
  - (i) there is no more than 3.5 g of uranium-235 per package;
  - (ii) the total plutonium and uranium-233 content does not exceed 1% of the mass of uranium-235 per package;
  - (iii) Transport of the package is subject to the consignment limit provided in 5.1.5.5.3;
- .4 Fissile nuclides with a total mass not greater than 2.0 g per package provided the package is transported subject to the consignment limit provided in 5.1.5.5.4;
- .5 Fissile nuclides with a total mass not greater than 45 g either packaged or unpackaged subject to limits provided in 5.1.5.5.5; and
- .6 A fissile material that meets the requirements of 5.1.5.5.2, 2.7.2.3.6 and 5.1.5.2.1."

### Table 2.7.2.3.5 – Consignment mass limits for exceptions from the requirements for packages containing fissile material

Table 2.7.2.3.5 is deleted.

Insert a new paragraph 2.7.2.3.6 to read as follows:

"2.7.2.3.6 A fissile material excepted from classification as "FISSILE" under 2.7.2.3.5.6 shall be subcritical without the need for accumulation control under the following conditions:

- .1 The conditions of 6.4.11.1 (a);

- .2 The conditions consistent with the assessment provisions stated in 6.4.11.12 (b) and 6.4.11.13 (b) for packages; and
- .3 The conditions specified in 6.4.11.11 (a), if transported by air."

#### 2.7.2.4 Classification of packages or unpacked material

##### 2.7.2.4.1 Classification as excepted package

###### 2.7.2.4.1.1 Amend to read as follows:

"2.7.2.4.1.1 A package may be classified as an excepted package if it meets one of the following conditions:

- .1 It is an empty package having contained radioactive material;
- .2 It contains instruments or articles not exceeding the activity limits specified in columns (2) and (3) of table 2.7.2.4.1.2;
- .3 It contains articles manufactured of natural uranium, depleted uranium or natural thorium;
- .4 It contains radioactive material not exceeding the activity limits specified in column (4) of table 2.7.2.4.1.2; or
- .5 It contains less than 0.1 kg of uranium hexafluoride not exceeding the activity limits specified in column (4) of table 2.7.2.4.1.2."

2.7.2.4.1.3 In the introductory sentence replace "only if" with "provided that".

2.7.2.4.1.3.2 Replace "except" with "on its external surface except for the following:"

and amend (ii) to read as follows:

- "(ii) consumer products that either have received regulatory approval in accordance with 1.5.1.4.5 or do not individually exceed the activity limit for an exempt consignment in table 2.7.2.2.1 (column 5), provided such products are transported in a package that bears the marking "RADIOACTIVE" on its internal surface in such a manner that a warning of the presence of radioactive material is visible on opening the package; "

and insert a new subparagraph "(iii)" under ".2" to read as follows:

- "(iii) Other instruments or articles too small to bear the marking "RADIOACTIVE", provided that they are transported in a package that bears the marking "RADIOACTIVE" on its internal surface in such a manner that a warning of the presence of radioactive material is visible on opening the package; and".

2.7.2.4.1.4.2 Amend to read as follows:

- ".2 The package bears the marking "RADIOACTIVE" on either:



- (i) An internal surface in such a manner that a warning of the presence of radioactive material is visible on opening the package; or
- (ii) The outside of the package, where it is impractical to mark an internal surface."

Insert a new 2.7.2.4.1.5 to read as follows:

"2.7.2.4.1.5 Uranium hexafluoride not exceeding the limits specified in column 4 of table 2.7.2.4.1.2 may be classified under UN 3507 URANIUM HEXAFLUORIDE, RADIOACTIVE MATERIAL, EXCEPTED PACKAGE, less than 0.1 kg per package, non-fissile or fissile-excepted provided that:

- .1 The mass of uranium hexafluoride in the package is less than 0.1 kg; and
- .2 The conditions of 2.7.2.4.5.1 and 2.7.2.4.1.4.1 and 2.7.2.4.1.4.2 are met."

and existing paragraph 2.7.2.4.1.5 is renumbered as "2.7.2.4.1.7".

2.7.2.4.1.6 Replace "only if" with "provided that".

2.7.2.4.1.7 (former 2.7.2.4.1.5) In the introductory sentence replace "only if" with "provided that".

2.7.2.4.4 *Classification as Type A package*

2.7.2.4.4 In the sentence before the subparagraphs, replace "activities greater than the following:" with "activities greater than either of the following:".

2.7.2.4.4.1 Delete "or".

2.7.2.4.4 In the legend for the formula where "C(j)", delete "and".

2.7.2.4.5 *Classification of uranium hexafluoride*

2.7.2.4.5 Amend to read as follows:

"2.7.2.4.5 *Classification of uranium hexafluoride*

2.7.2.4.5.1 Uranium hexafluoride shall only be assigned to:

- .1 UN No.2977, RADIOACTIVE MATERIAL, URANIUM HEXAFLUORIDE, FISSILE;
- .2 UN No.2978, RADIOACTIVE MATERIAL, URANIUM HEXAFLUORIDE, non-fissile or fissile-excepted; or
- .3 UN No.3507, URANIUM HEXAFLUORIDE, RADIOACTIVE MATERIAL, EXCEPTED PACKAGE less than 0.1 kg per package, non-fissile or fissile-excepted.

2.7.2.4.5.2 The contents of a package containing uranium hexafluoride shall comply with the following requirements:

- .1 For UN Nos. 2977 and 2978, the mass of uranium hexafluoride shall not be different from that allowed for the package design, and for UN 3507, the mass of uranium hexafluoride shall be less than 0.1 kg;
- .2 The mass of uranium hexafluoride shall not be greater than a value that would lead to an ullage smaller than 5% at the maximum temperature of the package as specified for the plant systems where the package shall be used; and
- .3 The uranium hexafluoride shall be in solid form and the internal pressure shall not be above atmospheric pressure when presented for transport."

2.7.2.4.6 *Classification as Type B(U), Type B(M) or Type C packages*

2.7.2.4.6.1 Replace "competent authority approval certificate" with "competent authority certificate of approval".

2.7.2.4.6.2 Amend to read:

"2.7.2.4.6.2 The contents of a Type B(U), Type B(M) or Type C package shall be as specified in the certificate of approval".

2.7.2.4.6.3 is deleted.

2.7.2.4.6.4 is deleted.

## **Chapter 2.9 – Miscellaneous dangerous substances and articles (class 9) and environmentally hazardous substances**

Amend "Note 2" to read as follows:

"Although the environmentally hazardous substances (aquatic environment) criteria apply to all hazard classes, except for class 7 (see paragraphs 2.10.2.3, 2.10.2.5 and 2.10.3.2), the criteria have been included in this chapter."

### **2.9.2 Assignment to class 9**

2.9.2.2 Under "Substances which, on inhalation as fine dust, may endanger health", replace all three entries by:

"2212 ASBESTOS, AMPHIBOLE (amosite, tremolite, actinolite, anthophyllite, crocidolite)

2590 ASBESTOS, CHRYSOTILE".

replace the existing heading "Electric double layer capacitors" with "Capacitors",

and replace the existing entry under this heading with the following two entries:

"3499 CAPACITOR, ELECTRIC DOUBLE LAYER (with an energy storage capacity greater than 0.3Wh)

3508 CAPACITOR, ASYMMETRIC (with an energy storage capacity greater than 0.3Wh)."

Under "Life-saving appliances", replace the three entries for UN No.3268 by:

"3268 SAFETY DEVICES, electrically initiated".

For "Other substances or articles presenting a danger during transport, but not meeting the definitions of another class", add the following new entry with the corresponding footnote:

"3509 PACKAGING DISCARDED, EMPTY, UNCLEANED\*\*\*"

Footnote: "\*\*\* This entry shall not be used for sea transport. Discarded packaging shall meet the requirements of 4.1.1.11."

#### 2.9.4 Lithium batteries

2.9.4.1 Replace the second sentence with the following:

"Cells and batteries manufactured according to a type meeting the requirements of subsection 38.3 of the Manual of Tests and Criteria, Revision 3, Amendment 1 or any subsequent revision and amendment applicable at the date of the type testing may continue to be transported, unless otherwise provided in this Code.

Cell and battery types only meeting the requirements of the Manual of Tests and Criteria, Revision 3, are no longer valid. However, cells and batteries manufactured in conformity with such types before 1 July 2003 may continue to be transported if all other applicable requirements are fulfilled."

and amend the note to read as follows:

**Note:** Batteries shall be of a type proved to meet the testing requirements of the *Manual of Tests and Criteria*, part III, sub-section 38.3, irrespective of whether the cells of which they are composed are of a tested type."

### Chapter 2.10 – Marine Pollutants

#### 2.10.2 General provisions

2.10.2.4 Amend to read as follows:

"2.10.2.4 Column 4 of the Dangerous Goods List also provides information on marine pollutants using the symbol **P** for single entries. The absence of the symbol P or the presence of a "-" in that column does not preclude the application of 2.10.3."

2.10.2.7 Add a new paragraph 2.10.2.7 as follows:

"2.10.2.7 *Marine pollutants packaged in single or combination packagings containing a net quantity per single or inner packaging of 5 l or less for*

*liquids or having a net mass per single or inner packaging of 5 kg or less for solids are not subject to any other provisions of this Code relevant to marine pollutants provided the packagings meet the general provisions of 4.1.1.1, 4.1.1.2 and 4.1.1.4 to 4.1.1.8. In the case of marine pollutants also meeting the criteria for inclusion in another hazard class all provisions of this Code relevant to any additional hazards continue to apply."*

### **2.10.3 Classification**

2.10.3.2 Add a new paragraph "2.10.3.2" to read as follows:

"2.10.3.2 The classification criteria of 2.9.3 are not applicable to substances or materials of class 7."

## **PART 3 DANGEROUS GOODS LIST, SPECIAL PROVISIONS AND EXEMPTIONS**

### **3.1 General**

#### **3.1.2 Proper shipping names**

##### **3.1.2.9 Marine pollutants**

3.1.2.9.1 Replace the existing paragraph 3.1.2.9.1 to read as follows:

"3.1.2.9.1 For the purpose of documentation, the Proper Shipping Name of generic or "not otherwise specified" (N.O.S.) entries which are classified as marine pollutants in accordance with 2.10.3, shall be supplemented with the recognized chemical name of the constituent which most predominantly contributes to the classification as marine pollutant."

#### **3.1.4 Segregation groups**

3.1.4.1 In the paragraph, replace the words "column 16" with "column 16b".

### **Chapter 3.2 – Dangerous Goods List**

#### **3.2.1 Structure of the dangerous goods list**

3.2.1 The following sentence is added at the end of column 4: "The absence of the symbol **P** or the presence of a "-" in that column does not preclude the application of 2.10.3."

3.2.1 The text for column 16 "column 16 Stowage and segregation – this column contains the stowage and segregation provisions as prescribed in part 7." is replaced with the following:

"Column 16a Stowage and handling – this column contains the stowage and handling codes as specified in 7.1.5 and 7.1.6.

Column 16 b Segregation – this column contains the segregation codes as specified in 7.2.8."

**Dangerous Goods List**

Replace the existing "column 16" with column "16a Stowage and handling" and "column "16b Segregation" as follows:

REORGANIZATION OF COLUMN 16 IN THE DANGEROUS GOODS LIST  
OF THE IMDG CODE

UN Number	PROPER SHIPPING NAME (Note: When there is more than one packing group or PSN the UN No. has been annotated with a, b, c)	Class or division	Subsidiary risk(s)	Packing Group	Stowage and Handling	Segregation
1	2	3	4	5	(16a)	(16b)
	3.1.2	"2.0	"2.0	2.0.1.3	7.1, 7.3-7.7	7.2-7.7
0004	AMMONIUM PICRATE dry or wetted with less than 10% water, by mass	1.1D			Category 04 SW1	SG27 SG31
0005	CARTRIDGES FOR WEAPONS with bursting charge	1.1F			Category 05 SW1	
0006	CARTRIDGES FOR WEAPONS with bursting charge	1.1E			Category 04 SW1	
0007	CARTRIDGES FOR WEAPONS with bursting charge	1.2F			Category 05 SW1	
0009	AMMUNITION, INCENDIARY with or without burster, expelling charge or propelling charge	1.2G			Category 03 SW1	
0010	AMMUNITION, INCENDIARY with or without burster, expelling charge or propelling charge	1.3G			Category 03 SW1	
0012	CARTRIDGES FOR WEAPONS, INERT PROJECTILE or CARTRIDGES, SMALL ARMS	1.4S			Category 01 SW1	
0014	CARTRIDGES FOR WEAPONS, BLANK or CARTRIDGES, SMALL ARMS, BLANK	1.4S			Category 01 SW1	
0015	AMMUNITION, SMOKE with or without burster, expelling charge or propelling charge	1.2G			Category 03 SW1	
0016	AMMUNITION, SMOKE with or without burster, expelling charge or propelling charge	1.3G			Category 03 SW1	
0018	AMMUNITION, TEAR-PRODUCING with burster, expelling charge or propelling charge	1.2G			Category 03 SW1	SG2
0019	AMMUNITION, TEAR-PRODUCING with burster, expelling charge or propelling charge	1.3G			Category 03 SW1	SG3
0020	AMMUNITION, TOXIC with burster, expelling charge or propelling charge	1.2K			Category 05 SW1	
0021	AMMUNITION, TOXIC with burster, expelling charge or propelling charge	1.3K			Category 05 SW1	
0027	BLACK POWDER (GUNPOWDER) granular, or as a meal	1.1D			Category 04 SW1	
0028	BLACK POWDER (GUNPOWDER), COMPRESSED or BLACK POWDER (GUNPOWDER) IN PELLETS	1.1D			Category 04 SW1	
0029	DETONATORS, NON-ELECTRIC for blasting	1.1B			Category 05 SW1	
0030	DETONATORS, ELECTRIC for blasting	1.1B			Category 05 SW1	
0033	BOMBS with bursting charge	1.1F			Category 05 SW1	
0034	BOMBS with bursting charge	1.1D			Category 04 SW1	
0035	BOMBS with bursting charge	1.2D			Category 04 SW1	
0037	BOMBS, PHOTO-FLASH	1.1F			Category 05 SW1	
0038	BOMBS, PHOTO-FLASH	1.1D			Category 04 SW1	

UN Number	PROPER SHIPPING NAME (Note: When there is more than one packing group or PSN the UN No. has been annotated with a, b, c)	Class or division	Subsidiary risk(s)	Packing Group	Stowage and Handling	Segregation
0039	BOMBS, PHOTO-FLASH	1.2G			Category 03 SW1	
0042	BOOSTERS without detonator	1.1D			Category 04 SW1	
0043	BURSTERS explosive	1.1D			Category 04 SW1	
0044	PRIMERS, CAP TYPE	1.4S			Category 01 SW1	
0048	CHARGES, DEMOLITION	1.1D			Category 04 SW1	
0049	CARTRIDGES, FLASH	1.1G			Category 03 SW1	
0050	CARTRIDGES, FLASH	1.3G			Category 03 SW1	
0054	CARTRIDGES, SIGNAL	1.3G			Category 03 SW1	
0055	CASES, CARTRIDGE, EMPTY, WITH PRIMER	1.4S			Category 01 SW1	
0056	CHARGES, DEPTH	1.1D			Category 04 SW1	
0059	CHARGES, SHAPED without detonator	1.1D			Category 04 SW1	
0060	CHARGES, SUPPLEMENTARY, EXPLOSIVE	1.1D			Category 04 SW1	
0065	CORD, DETONATING flexible	1.1D			Category 04 SW1	
0066	CORD, IGNITER	1.4G			Category 02 SW1	
0070	CUTTERS, CABLE, EXPLOSIVE	1.4S			Category 01 SW1	
0072	CYCLOTRIMETHYLENETRINITRAMINE, (CYCLONITE), (RDX), (HEXOGEN), WETTED with not less than 15% water, by mass	1.1D			Category 04 SW1	
0073	DETONATORS FOR AMMUNITION	1.1B			Category 05 SW1	
0074	DIAZODINITROPHENOL, WETTED with not less than 40% water or mixture of alcohol and water, by mass	1.1A			Category 05 SW1	
0075	DIETHYLENEGLYCOL DINITRATE, DESENSITIZED with not less than 25% non-volatile water-insoluble phlegmatizer, by mass	1.1D			Category 04 SW1	
0076	DINITROPHENOL dry or wetted with less than 15% water, by mass	1.1D			Category 04 SW1	SG31
0077	DINITROPHENOLATES alkali metals, dry or wetted with less than 15% water, by mass	1.3C			Category 04 SW1	SG31
0078	DINITRORESORCINOL dry or wetted with less than 15% water, by mass	1.1D			Category 04 SW1	SG31
0079	HEXANITRODIPHENYLAMINE (DIPICRYLAMINE), (HEXYL)	1.1D			Category 04 SW1	
0081	EXPLOSIVE, BLASTING, TYPE A	1.1D			Category 04 SW1	SG34
0082	EXPLOSIVE, BLASTING, TYPE B	1.1D			Category 04 SW1	SG34
0083	EXPLOSIVE, BLASTING, TYPE C	1.1D			Category 04 SW1	SG28
0084	EXPLOSIVE, BLASTING, TYPE D	1.1D			Category 04 SW1	

UN Number	PROPER SHIPPING NAME (Note: When there is more than one packing group or PSN the UN No. has been annotated with a, b, c)	Class or division	Subsidiary risk(s)	Packing Group	Stowage and Handling	Segregation
0092	FLARES, SURFACE	1.3G			Category 03 SW1	
0093	FLARES, AERIAL	1.3G			Category 03 SW1	
0094	FLASH POWDER	1.1G			Category 03 SW1	
0099	FRACTURING DEVICES, EXPLOSIVE for oil wells, without detonator	1.1D			Category 04 SW1	
0101	FUSE, NON-DETONATING	1.3G			Category 03 SW1	
0102	CORD (FUSE), DETONATING metal-clad	1.2D			Category 04 SW1	
0103	FUSE, IGNITER tubular, metal-clad	1.4G			Category 02 SW1	
0104	CORD (FUSE), DETONATING, MILD EFFECT metal-clad	1.4D			Category 02 SW1	
0105	FUSE, SAFETY	1.4S			Category 01 SW1	
0106	FUZES, DETONATING	1.1B			Category 05 SW1	
0107	FUZES, DETONATING	1.2B			Category 05 SW1	
0110	GRENADES, PRACTICE hand or rifle	1.4S			Category 01 SW1	
0113	GUANYL NITROSAMINO GUANYLIDENE HYDRAZINE, WETTED with not less than 30% water, by mass	1.1A			Category 05 SW1	
0114	GUANYL NITROSAMINO GUANYLTETRAZENE (TETRAZENE), WETTED with not less than 30% water or mi	1.1A			Category 05 SW1	
0118	HEXOLITE (HEXOTOL) dry or wetted with less than 15% water, by mass	1.1D			Category 04 SW1	
0121	IGNITERS	1.1G			Category 03 SW1	
0124	JET PERFORATING GUNS, CHARGED oil well, without detonator	1.1D			Category 04 SW1	
0129	LEAD AZIDE, WETTED with not less than 20% water, or mixture of alcohol and water, by mas	1.1A			Category 05 SW1	
0130	LEAD STYPHNATE (LEAD TRINITRORESORCINATE), WETTED with not less than 20% water, or mixtu	1.1A			Category 05 SW1	
0131	LIGHTERS, FUSE	1.4S			Category 01 SW1	
0132	DEFLAGRATING METAL SALTS OF AROMATIC NITRODERIVATIVES, N.O.S.	1.3C			Category 04 SW1	SG31
0133	MANNITOL HEXANITRATE (NITROMANNITE), WETTED with not less than 40% water, or mixture of alcohol and water, by mass	1.1D			Category 04 SW1	
0135	MERCURY FULMINATE, WETTED with not less than 20% water, or mixture of alcohol and water, by mass	1.1A			Category 05 SW1	
0136	MINES with bursting charge	1.1F			Category 05 SW1	
0137	MINES with bursting charge	1.1D			Category 04 SW1	
0138	MINES with bursting charge	1.2D			Category 04 SW1	



UN Number	PROPER SHIPPING NAME (Note: When there is more than one packing group or PSN the UN No. has been annotated with a, b, c)	Class or division	Subsidiary risk(s)	Packing Group	Stowage and Handling	Segregation
0143	NITROGLYCERIN, DESENSITIZED with not less than 40% non-volatile water-insoluble phlegmatizer, by mass	1.1D			Category 04 SW1	
0144	NITROGLYCERIN SOLUTION IN ALCOHOL with more than 1% but not more than 10% nitroglycerin	1.1D			Category 04 SW1	
0146	NITROSTARCH dry or wetted, with less than 20% water, by mass	1.1D			Category 04 SW1	
0147	NITRO UREA	1.1D			Category 04 SW1	
0150	PENTAERYTHRITE TETRANITRATE (PENTAERYTHRITOL TETRANITRATE; PETN), WETTED with not less than 25% water, by mass or PENTAERYTHRITE TETRANITRATE (PENTAERYTHRITOL TETRANITRATE; PETN), DESENSITIZED with not less than 15% phlegmatizer, by mass	1.1D			Category 04 SW1	
0151	PENTOLITE dry or wetted with less than 15% water, by mass	1.1D			Category 04 SW1	
0153	TRINITROANILINE (PICRAMIDE)	1.1D			Category 04 SW1	
0154	TRINITROPHENOL (PICRIC ACID) dry or wetted with less than 30% water, by mass	1.1D			Category 04 SW1	SG31
0155	TRINITROCHLOROBENZENE (PICRYL CHLORIDE)	1.1D			Category 04 SW1	
0159	POWDER CAKE (POWDER PASTE), WETTED with not less than 25% water, by mass	1.3C			Category 04 SW1	
0160	POWDER, SMOKELESS	1.1C			Category 04 SW1	
0161	POWDER, SMOKELESS	1.3C			Category 04 SW1	
0167	PROJECTILES with bursting charge	1.1F			Category 05 SW1	
0168	PROJECTILES with bursting charge	1.1D			Category 04 SW1	
0169	PROJECTILES with bursting charge	1.2D			Category 04 SW1	
0171	AMMUNITION, ILLUMINATING with or without burster, expelling charge or propelling charge	1.2G			Category 03 SW1	
0173	RELEASE DEVICES, EXPLOSIVE	1.4S			Category 01 SW1	
0174	RIVETS, EXPLOSIVE	1.4S			Category 01 SW1	
0180	ROCKETS with bursting charge	1.1F			Category 05 SW1	
0181	ROCKETS with bursting charge	1.1E			Category 04 SW1	
0182	ROCKETS with bursting charge	1.2E			Category 04 SW1	
0183	ROCKETS with inert head	1.3C			Category 04 SW1	
0186	ROCKET MOTORS	1.3C			Category 04 SW1	
0190	SAMPLES, EXPLOSIVE other than initiating explosive	1			Category 05 SW1	

UN Number	PROPER SHIPPING NAME (Note: When there is more than one packing group or PSN the UN No. has been annotated with a, b, c)	Class or division	Subsidiary risk(s)	Packing Group	Stowage and Handling	Segregation
0191	SIGNAL DEVICES, HAND	1.4G			Category 02 SW1	
0192	SIGNALS, RAILWAY TRACK, EXPLOSIVE	1.1G			Category 03 SW1	
0193	SIGNALS, RAILWAY TRACK, EXPLOSIVE	1.4S			Category 01 SW1	
0194	SIGNALS, DISTRESS ship	1.1G			Category 03 SW1	
0195	SIGNALS, DISTRESS ship	1.3G			Category 03 SW1	
0196	SIGNALS, SMOKE	1.1G			Category 03 SW1	
0197	SIGNALS, SMOKE	1.4G			Category 02 SW1	
0204	SOUNDING DEVICES, EXPLOSIVE	1.2F			Category 05 SW1	
0207	TETRANITROANILINE	1.1D			Category 04 SW1	
0208	TRINITROPHENYLMETHYLNITR AMINE (TETRYL)	1.1D			Category 04 SW1	
0209	TRINITROTOLUENE (TNT) dry or wetted with less than 30% water, by mass	1.1D			Category 04 SW1	
0212	TRACERS FOR AMMUNITION	1.3G			Category 03 SW1	
0213	TRINITROANISOLE	1.1D			Category 04 SW1	
0214	TRINITROBENZENE dry or wetted with less than 30% water, by mass	1.1D			Category 04 SW1	
0215	TRINITROBENZOIC ACID dry or wetted with less than 30% water, by mass	1.1D			Category 04 SW1	
0216	TRINITRO-m-CRESOL	1.1D			Category 04 SW1	SG31
0217	TRINITRONAPHTHALENE	1.1D			Category 04 SW1	
0218	TRINITROPHENETOLE	1.1D			Category 04 SW1	
0219	TRINITRORESORCINOL (STYPHNIC ACID) dry or wetted with less than 20% water, or mixture of	1.1D			Category 04 SW1	SG27
0220	UREA NITRATE dry or wetted with less than 20% water, by mass	1.1D			Category 04 SW1	
0221	WARHEADS, TORPEDO with bursting charge	1.1D			Category 04 SW1	
0222	AMMONIUM NITRATE with more than 0.2% by mass of combustible substances, including any organic substance calculated as carbon, to the exclusion of any other added substance	1.1D			Category 04 SW1	SG27
0224	BARIUM AZIDE, dry or wetted with less than 50% water, by mass	1.1A			Category 05 SW1	
0225	BOOSTERS WITH DETONATOR	1.1B			Category 05 SW1	
0226	CYCLOTETRAMETHYLENETETRA NITRAMINE (HMX; OCTOGEN), WETTED with not less than 15% water, by mass	1.1D			Category 04 SW1	
0234	SODIUM DINITRO-ortho-CRESOLATE dry or wetted with less than 15% water, by mass	1.3C			Category 04 SW1	SG31

UN Number	PROPER SHIPPING NAME (Note: When there is more than one packing group or PSN the UN No. has been annotated with a, b, c.)	Class or division	Subsidiary risk(s)	Packing Group	Stowage and Handling	Segregation
0235	SODIUM PICRAMATE dry or wetted with less than 20% water, by mass	1.3C			Category 04 SW1	SG31
0236	ZIRCONIUM PICRAMATE dry or wetted with less than 20% water, by mass	1.3C			Category 04 SW1	SG31
0237	CHARGES, SHAPED, FLEXIBLE, LINEAR	1.4D			Category 02 SW1	
0238	ROCKETS, LINE-THROWING	1.2G			Category 03 SW1	
0240	ROCKETS, LINE-THROWING	1.3G			Category 03 SW1	
0241	EXPLOSIVE, BLASTING, TYPE E	1.1D			Category 04 SW1	SG34
0242	CHARGES, PROPELLING, FOR CANNON	1.3C			Category 04 SW1	
0243	AMMUNITION, INCENDIARY, WHITE PHOSPHORUS with burster, expelling charge or propelling ch	1.2H			Category 05 SW1	
0244	AMMUNITION, INCENDIARY, WHITE PHOSPHORUS with burster, expelling charge or propelling ch	1.3H			Category 05 SW1	
0245	AMMUNITION, SMOKE, WHITE PHOSPHORUS with burster, expelling charge or propelling charge	1.2H			Category 05 SW1	
0246	AMMUNITION, SMOKE, WHITE PHOSPHORUS with burster, expelling charge or propelling charge	1.3H			Category 05 SW1	
0247	AMMUNITION, INCENDIARY liquid or gel, with burster, expelling charge or propelling charge	1.3J			Category 05 SW1	
0248	CONTRIVANCES, WATER-ACTIVATED with burster, expelling charge or propelling charge	1.2L			Category 05 SW1	
0249	CONTRIVANCES, WATER-ACTIVATED with burster, expelling charge or propelling charge	1.3L			Category 05 SW1	
0250	ROCKET MOTORS WITH HYPERGOLIC LIQUIDS with or without expelling charge	1.3L			Category 05 SW1	
0254	AMMUNITION, ILLUMINATING with or without burster, expelling charge or propelling charge	1.3G			Category 03 SW1	
0255	DETONATORS, ELECTRIC for blasting	1.4B			Category 05 SW1	
0257	FUZES, DETONATING	1.4B			Category 05 SW1	
0266	OCTOLITE (OCTOL) dry or wetted with less than 15% water, by mass	1.1D			Category 04 SW1	
0267	DETONATORS, NON-ELECTRIC for blasting	1.4B			Category 05 SW1	
0268	BOOSTERS WITH DETONATOR	1.2B			Category 05 SW1	
0271	CHARGES, PROPELLING	1.1C			Category 04 SW1	
0272	CHARGES, PROPELLING	1.3C			Category 04 SW1	
0275	CARTRIDGES, POWER DEVICE	1.3C			Category 04 SW1	
0276	CARTRIDGES, POWER DEVICE	1.4C			Category 02 SW1	
0277	CARTRIDGES, OIL WELL	1.3C			Category 04 SW1	

UN Number	PROPER SHIPPING NAME (Note: When there is more than one packing group or PSN the UN No. has been annotated with a, b, c)	Class or division	Subsidiary risk(s)	Packing Group	Stowage and Handling	Segregation
0278	CARTRIDGES, OIL WELL	1.4C			Category 02 SW1	
0279	CHARGES, PROPELLING, FOR CANNON	1.1C			Category 04 SW1	
0280	ROCKET MOTORS	1.1C			Category 04 SW1	
0281	ROCKET MOTORS	1.2C			Category 04 SW1	
0282	NITROGUANIDINE (PICRITE) dry or wetted with less than 20% water, by mass	1.1D			Category 04 SW1	
0283	BOOSTERS without detonator	1.2D			Category 04 SW1	
0284	GRENADERS hand or rifle, with bursting charge	1.1D			Category 04 SW1	
0285	GRENADERS hand or rifle, with bursting charge	1.2D			Category 04 SW1	
0286	WARHEADS, ROCKET with bursting charge	1.1D			Category 04 SW1	
0287	WARHEADS, ROCKET with bursting charge	1.2D			Category 04 SW1	
0288	CHARGES, SHAPED, FLEXIBLE, LINEAR	1.1D			Category 04 SW1	
0289	CORD, DETONATING flexible	1.4D			Category 02 SW1	
0290	CORD(FUSE), DETONATING metal-clad	1.1D			Category 04 SW1	
0291	BOMBS with bursting charge	1.2F			Category 05 SW1	
0292	GRENADERS hand or rifle, with bursting charge	1.1F			Category 05 SW1	
0293	GRENADERS hand or rifle, with bursting charge	1.2F			Category 05 SW1	
0294	MINES with bursting charge	1.2F			Category 05 SW1	
0295	ROCKETS with bursting charge	1.2F			Category 05 SW1	
0296	SOUNDING DEVICES, EXPLOSIVE	1.1F			Category 05 SW1	
0297	AMMUNITION, ILLUMINATING with or without burster, expelling charge or propelling charge	1.4G			Category 02 SW1	
0299	BOMBS, PHOTO-FLASH	1.3G			Category 03 SW1	
0300	AMMUNITION, INCENDIARY with or without burster, expelling charge or propelling charge	1.4G			Category 02 SW1	
0301	AMMUNITION, TEAR-PRODUCING with burster, expelling charge or propelling charge	1.4G			Category 02 SW1	SG74
0303	AMMUNITION, SMOKE with or without burster, expelling charge or propelling charge	1.4G			Category 02 SW1	
0305	FLASH POWDER	1.3G			Category 03 SW1	
0306	TRACERS FOR AMMUNITION	1.4G			Category 02 SW1	
0312	CARTRIDGES, SIGNAL	1.4G			Category 02 SW1	
0313	SIGNALS, SMOKE	1.2G			Category 03 SW1	

UN Number	PROPER SHIPPING NAME (Note: When there is more than one packing group or PSN the UN No. has been annotated with a, b, c)	Class or division	Subsidiary risk(s)	Packing Group	Stowage and Handling	Segregation
0314	IGNITERS	1.2G			Category 03 SW1	
0315	IGNITERS	1.3G			Category 03 SW1	
0316	FUZES, IGNITING	1.3G			Category 03 SW1	
0317	FUZES, IGNITING	1.4G			Category 02 SW1	
0318	GRENADES, PRACTICE hand or rifle	1.3G			Category 03 SW1	
0319	PRIMERS, TUBULAR	1.3G			Category 03 SW1	
0320	PRIMERS, TUBULAR	1.4G			Category 02 SW1	
0321	CARTRIDGES FOR WEAPONS with bursting charge	1.2E			Category 04 SW1	
0322	ROCKET MOTORS WITH HYPERGOLIC LIQUIDS with or without expelling charge	1.2L			Category 05 SW1	
0323	CARTRIDGES, POWER DEVICE	1.4S			Category 01 SW1	
0324	PROJECTILES with bursting charge	1.2F			Category 05 SW1	
0325	IGNITERS	1.4G			Category 02 SW1	
0326	CARTRIDGES FOR WEAPONS, BLANK	1.1C			Category 04 SW1	
0327	CARTRIDGES FOR WEAPONS, BLANK or CARTRIDGES, SMALL ARMS, BLANK	1.3C			Category 04 SW1	
0328	CARTRIDGES FOR WEAPONS, INERT PROJECTILE	1.2C			Category 04 SW1	
0329	TORPEDOES with bursting charge	1.1E			Category 04 SW1	
0330	TORPEDOES with bursting charge	1.1F			Category 05 SW1	
0331	EXPLOSIVE, BLASTING, TYPE B (AGENT, BLASTING, TYPE B)	1.5D			Category 03 SW1	SG34
0332	EXPLOSIVE, BLASTING, TYPE E (AGENT, BLASTING, TYPE E)	1.5D			Category 03 SW1	SG34
0333	FIREWORKS	1.1G			Category 03 SW1	
0334	FIREWORKS	1.2G			Category 03 SW1	
0335	FIREWORKS	1.3G			Category 03 SW1	
0336	FIREWORKS	1.4G			Category 02 SW1	
0337	FIREWORKS	1.4S			Category 01 SW1	
0338	CARTRIDGES FOR WEAPONS, BLANK or CARTRIDGES, SMALL ARMS, BLANK	1.4C			Category 02 SW1	
0339	CARTRIDGES FOR WEAPONS, INERT PROJECTILE or CARTRIDGES, SMALL ARMS	1.4C			Category 02 SW1	
0340	NITROCELLULOSE dry or wetted with less than 25% water (or alcohol), by mass	1.1D			Category 04 SW1	
0341	NITROCELLULOSE unmodified or plasticized with less than 18% plasticizing substance, by mass	1.1D			Category 04 SW1	

UN Number	PROPER SHIPPING NAME (Note: When there is more than one packing group or PSN the UN No. has been annotated with a, b, c)	Class or division	Subsidiary risk(s)	Packing Group	Stowage and Handling	Segregation
0342	NITROCELLULOSE, WETTED with not less than 25% alcohol, by mass	1.3C			Category 04 SW1	
0343	NITROCELLULOSE, PLASTICIZED with not less than 18% plasticizing substance, by mass	1.3C			Category 04 SW1	
0344	PROJECTILES with bursting charge	1.4D			Category 02 SW1	
0345	PROJECTILES inert, with tracer	1.4S			Category 01 SW1	
0346	PROJECTILES with burster or expelling charge	1.2D			Category 04 SW1	
0347	PROJECTILES with burster or expelling charge	1.4D			Category 02 SW1	
0348	CARTRIDGES FOR WEAPONS with bursting charge	1.4F			Category 05 SW1	
0349	ARTICLES, EXPLOSIVE, N.O.S.	1.4S			Category 01 SW1	
0350	ARTICLES, EXPLOSIVE, N.O.S.	1.4B			Category 05 SW1	
0351	ARTICLES, EXPLOSIVE, N.O.S.	1.4C			Category 02 SW1	
0352	ARTICLES, EXPLOSIVE, N.O.S.	1.4D			Category 02 SW1	
0353	ARTICLES, EXPLOSIVE, N.O.S.	1.4G			Category 02 SW1	
0354	ARTICLES, EXPLOSIVE, N.O.S.	1.1L	See SP943		Category 05 SW1	
0355	ARTICLES, EXPLOSIVE, N.O.S.	1.2L	See SP943		Category 05 SW1	
0356	ARTICLES, EXPLOSIVE, N.O.S.	1.3L	See SP943		Category 05 SW1	
0357	SUBSTANCES, EXPLOSIVE, N.O.S.	1.1L			Category 05 SW1	
0358	SUBSTANCES, EXPLOSIVE, N.O.S.	1.2L			Category 05 SW1	
0359	SUBSTANCES, EXPLOSIVE, N.O.S.	1.3L			Category 05 SW1	
0360	DETONATOR ASSEMBLIES, NON-ELECTRIC for blasting	1.1B			Category 05 SW1	
0361	DETONATOR ASSEMBLIES, NON-ELECTRIC for blasting	1.4B			Category 05 SW1	
0362	AMMUNITION, PRACTICE	1.4G			Category 02 SW1	
0363	AMMUNITION, PROOF	1.4G			Category 02 SW1	
0364	DETONATORS FOR AMMUNITION	1.2B			Category 05 SW1	
0365	DETONATORS FOR AMMUNITION	1.4B			Category 05 SW1	
0366	DETONATORS FOR AMMUNITION	1.4S			Category 01 SW1	
0367	FUZES, DETONATING	1.4S			Category 01 SW1	
0368	FUZES, IGNITING	1.4S			Category 01 SW1	
0369	WARHEADS, ROCKET with bursting charge	1.1F			Category 05 SW1	

UN Number	PROPER SHIPPING NAME (Note: When there is more than one packing group or PSN the UN No. has been annotated with a, b, c)	Class or division	Subsidiary risk(s)	Packing Group	Stowage and Handling	Segregation
0370	WARHEADS, ROCKET with burster or expelling charge	1.4D			Category 02 SW1	
0371	WARHEADS, ROCKET with burster or expelling charge	1.4F			Category 05 SW1	
0372	GRENADES, PRACTICE hand or rifle	1.2G			Category 03 SW1	
0373	SIGNAL DEVICES, HAND	1.4S			Category 01 SW1	
0374	SOUNDING DEVICES, EXPLOSIVE	1.1D			Category 04 SW1	
0375	SOUNDING DEVICES, EXPLOSIVE	1.2D			Category 04 SW1	
0376	PRIMERS, TUBULAR	1.4S			Category 01 SW1	
0377	PRIMERS, CAP TYPE	1.1B			Category 05 SW1	
0378	PRIMERS, CAP TYPE	1.4B			Category 05 SW1	
0379	CASES, CARTRIDGE, EMPTY, WITH PRIMER	1.4C			Category 02 SW1	
0380	ARTICLES, PYROPHORIC	1.2L			Category 05 SW1	
0381	CARTRIDGES, POWER DEVICE	1.2C			Category 04 SW1	
0382	COMPONENTS, EXPLOSIVE TRAIN, N.O.S.	1.2B			Category 05 SW1	
0383	COMPONENTS, EXPLOSIVE TRAIN, N.O.S.	1.4B			Category 05 SW1	
0384	COMPONENTS, EXPLOSIVE TRAIN, N.O.S.	1.4S			Category 01 SW1	
0385	5-NITROBENZOTRIAZOL	1.1D			Category 04 SW1	
0386	TRINITROBENZENESULPHONIC ACID	1.1D			Category 04 SW1	SG31
0387	TRINITROFLUORENONE	1.1D			Category 04 SW1	
0388	TRINITROTOLUENE (TNT) AND TRINITROBENZENE MIXTURE or TRINITROTOLUENE (TNT) AND HEXANITROSTILBENE MIXTURE	1.1D			Category 04 SW1	
0389	TRINITROTOLUENE (TNT) MIXTURE CONTAINING TRINITROBENZENE AND HEXANITROSTILBENE	1.1D			Category 04 SW1	
0390	TRITONAL	1.1D			Category 04 SW1	
0391	CYCLOTTRIMETHYLENETRINITRAMINE (CYCLONITE; HEXOGEN; RDX) AND CYCLOTETRAMETHYLENETETRANITRAMINE (HMX; OCTOGEN) MIXTURE, WETTED with not less than 15% water, by mass or CYCLOTTRIMETHYLENETRINITRAMINE (CYCLONITE; HEXOGEN; RDX) AND CYCLOTETRAMETHYLENETETRANITRAMINE (HMX; OCTOGEN) MIXTURE, DESENSITIZED with not less than 10% phlegmatizer, by mass	1.1D			Category 04 SW1	

UN Number	PROPER SHIPPING NAME (Note: When there is more than one packing group or PSN the UN No. has been annotated with a, b, c)	Class or division	Subsidiary risk(s)	Packing Group	Stowage and Handling	Segregation
0392	HEXANITROSTILBENE	1.1D			Category 04 SW1	
0393	HEXOTONAL	1.1D			Category 04 SW1	
0394	TRINITRORESORCINOL (STYPHNIC ACID), WETTED with not less than 20% water, or mixture of a	1.1D			Category 04 SW1	SG31
0395	ROCKET MOTORS, LIQUID FUELLED	1.2J			Category 05 SW1	SG67
0396	ROCKET MOTORS, LIQUID FUELLED	1.3J			Category 05 SW1	SG67
0397	ROCKETS, LIQUID FUELLED with bursting charge	1.1J			Category 05 SW1	SG67
0398	ROCKETS, LIQUID FUELLED with bursting charge	1.2J			Category 05 SW1	SG67
0399	BOMBS WITH FLAMMABLE LIQUID with bursting charge	1.1J			Category 05 SW1	SG67
0400	BOMBS WITH FLAMMABLE LIQUID with bursting charge	1.2J			Category 05 SW1	SG67
0401	DIPICRYL SULPHIDE dry or wetted with less than 10% water, by mass	1.1D			Category 04 SW1	
0402	AMMONIUM PERCHLORATE	1.1D			Category 04 SW1	SG27
0403	FLARES, AERIAL	1.4G			Category 02 SW1	
0404	FLARES, AERIAL	1.4S			Category 01 SW1	
0405	CARTRIDGES, SIGNAL	1.4S			Category 01 SW1	
0406	DINITROSOBENZENE	1.3C			Category 04 SW1	
0407	TETRAZOL-1-ACETIC ACID	1.4C			Category 02 SW1	
0408	FUZES, DETONATING with protective features	1.1D			Category 04 SW1	
0409	FUZES, DETONATING with protective features	1.2D			Category 04 SW1	
0410	FUZES, DETONATING with protective features	1.4D			Category 02 SW1	
0411	PENTAERYTHRITATE TETRANITRATE (PENTAERYTHRITOL TETRANITRATE; PETN) with not less than 7% wax, by mass	1.1D			Category 04 SW1	
0412	CARTRIDGES FOR WEAPONS with bursting charge	1.4E			Category 03 SW1	
0413	CARTRIDGES FOR WEAPONS, BLANK	1.2C			Category 04 SW1	
0414	CHARGES, PROPELLING, FOR CANNON	1.2C			Category 04 SW1	
0415	CHARGES, PROPELLING	1.2C			Category 04 SW1	
0417	CARTRIDGES FOR WEAPONS, INERT PROJECTILE or CARTRIDGES, SMALL ARMS	1.3C			Category 04 SW1	
0418	FLARES, SURFACE	1.1G			Category 03 SW1	
0419	FLARES, SURFACE	1.2G			Category 03 SW1	



UN Number	PROPER SHIPPING NAME (Note: When there is more than one packing group or PSN the UN No. has been annotated with a, b, c)	Class or division	Subsidiary risk(s)	Packing Group	Stowage and Handling	Segregation
0420	FLARES, AERIAL	1.1G			Category 03 SW1	
0421	FLARES, AERIAL	1.2G			Category 03 SW1	
0424	PROJECTILES inert, with tracer	1.3G			Category 03 SW1	
0425	PROJECTILES inert, with tracer	1.4G			Category 02 SW1	
0426	PROJECTILES with burster or expelling charge	1.2F			Category 05 SW1	
0427	PROJECTILES with burster or expelling charge	1.4F			Category 05 SW1	
0428	ARTICLES, PYROTECHNIC for technical purposes	1.1G			Category 03 SW1	
0429	ARTICLES, PYROTECHNIC for technical purposes	1.2G			Category 03 SW1	
0430	ARTICLES, PYROTECHNIC for technical purposes	1.3G			Category 03 SW1	
0431	ARTICLES, PYROTECHNIC for technical purposes	1.4G			Category 02 SW1	
0432	ARTICLES, PYROTECHNIC for technical purposes	1.4S			Category 01 SW1	
0433	POWDER CAKE (POWDER PASTE), WETTED with not less than 17% alcohol, by mass	1.1C			Category 04 SW1	
0434	PROJECTILES with burster or expelling charge	1.2G			Category 03 SW1	
0435	PROJECTILES with burster or expelling charge	1.4G			Category 02 SW1	
0436	ROCKETS with expelling charge	1.2C			Category 04 SW1	
0437	ROCKETS with expelling charge	1.3C			Category 04 SW1	
0438	ROCKETS with expelling charge	1.4C			Category 02 SW1	
0439	CHARGES, SHAPED without detonator	1.2D			Category 04 SW1	
0440	CHARGES, SHAPED without detonator	1.4D			Category 02 SW1	
0441	CHARGES, SHAPED without detonator	1.4S			Category 01 SW1	
0442	CHARGES, EXPLOSIVE, COMMERCIAL without detonator	1.1D			Category 04 SW1	
0443	CHARGES, EXPLOSIVE, COMMERCIAL without detonator	1.2D			Category 04 SW1	
0444	CHARGES, EXPLOSIVE, COMMERCIAL without detonator	1.4D			Category 02 SW1	
0445	CHARGES, EXPLOSIVE, COMMERCIAL without detonator	1.4S			Category 01 SW1	
0446	CASES, COMBUSTIBLE, EMPTY, WITHOUT PRIMER	1.4C			Category 02 SW1	
0447	CASES, COMBUSTIBLE, EMPTY, WITHOUT PRIMER	1.3C			Category 04 SW1	
0448	5-MERCAPTOTETRAZOL-1-ACETIC ACID	1.4C			Category 02 SW1	
0449	TORPEDOES, LIQUID-FUELLED with or without bursting charge	1.1J			Category 05 SW1	SG67

UN Number	PROPER SHIPPING NAME (Note: When there is more than one packing group or PSN the UN No. has been annotated with a, b, c)	Class or division	Subsidiary risk(s)	Packing Group	Stowage and Handling	Segregation
0450	TORPEDOES, LIQUID-FUELLED with inert head	1.3J			Category 05 SW1	SG67
0451	TORPEDOES with bursting charge	1.1D			Category 04 SW1	
0452	GRENADES, PRACTICE hand or rifle	1.4G			Category 02 SW1	
0453	ROCKETS, LINE-THROWING	1.4G			Category 02 SW1	
0454	IGNITERS	1.4S			Category 01 SW1	
0455	DETONATORS, NON-ELECTRIC for blasting	1.4S			Category 01 SW1	
0456	DETONATORS, ELECTRIC for blasting	1.4S			Category 01 SW1	
0457	CHARGES, BURSTING, PLASTICS BONDED	1.1D			Category 04 SW1	
0458	CHARGES, BURSTING, PLASTICS BONDED	1.2D			Category 04 SW1	
0459	CHARGES, BURSTING, PLASTICS BONDED	1.4D			Category 02 SW1	
0460	CHARGES, BURSTING, PLASTICS BONDED	1.4S			Category 01 SW1	
0461	COMPONENTS, EXPLOSIVE TRAIN, N.O.S.	1.1B			Category 05 SW1	
0462	ARTICLES, EXPLOSIVE, N.O.S.	1.1C			Category 04 SW1	
0463	ARTICLES, EXPLOSIVE, N.O.S.	1.1D			Category 04 SW1	
0464	ARTICLES, EXPLOSIVE, N.O.S.	1.1E			Category 04 SW1	
0465	ARTICLES, EXPLOSIVE, N.O.S.	1.1F			Category 05 SW1	
0466	ARTICLES, EXPLOSIVE, N.O.S.	1.2C			Category 04 SW1	
0467	ARTICLES, EXPLOSIVE, N.O.S.	1.2D			Category 04 SW1	
0468	ARTICLES, EXPLOSIVE, N.O.S.	1.2E			Category 04 SW1	
0469	ARTICLES, EXPLOSIVE, N.O.S.	1.2F			Category 05 SW1	
0470	ARTICLES, EXPLOSIVE, N.O.S.	1.3C			Category 04 SW1	
0471	ARTICLES, EXPLOSIVE, N.O.S.	1.4E			Category 03 SW1	
0472	ARTICLES, EXPLOSIVE, N.O.S.	1.4F			Category 05 SW1	
0473	SUBSTANCES, EXPLOSIVE, N.O.S.	1.1A			Category 05 SW1	
0474	SUBSTANCES, EXPLOSIVE, N.O.S.	1.1C			Category 04 SW1	
0475	SUBSTANCES, EXPLOSIVE, N.O.S.	1.1D			Category 04 SW1	
0476	SUBSTANCES, EXPLOSIVE, N.O.S.	1.1G			Category 03 SW1	
0477	SUBSTANCES, EXPLOSIVE, N.O.S.	1.3C			Category 04 SW1	

UN Number	PROPER SHIPPING NAME (Note: When there is more than one packing group or PSN the UN No. has been annotated with a, b, c)	Class or division	Subsidiary risk(s)	Packing Group	Stowage and Handling	Segregation
0478	SUBSTANCES, EXPLOSIVE, N.O.S.	1.3G			Category 03 SW1	
0479	SUBSTANCES, EXPLOSIVE, N.O.S.	1.4C			Category 02 SW1	
0480	SUBSTANCES, EXPLOSIVE, N.O.S.	1.4D			Category 02 SW1	
0481	SUBSTANCES, EXPLOSIVE, N.O.S.	1.4S			Category 01 SW1	
0482	SUBSTANCES, EXPLOSIVE, VERY INSENSITIVE (SUBSTANCES, EVI), N.O.S.	1.5D			Category 03 SW1	
0483	CYCLOTRIMETHYLENETRINITRAMINE (CYCLONITE; HEXOGEN; RDX), DESENSITIZED	1.1D			Category 04 SW1	
0484	CYCLOTETRAMETHYLENETETRANITRAMINE (OCTOGEN; HMX), DESENSITIZED	1.1D			Category 04 SW1	
0485	SUBSTANCES, EXPLOSIVE, N.O.S.	1.4G			Category 02 SW1	
0486	ARTICLES, EXPLOSIVE, EXTREMELY INSENSITIVE (ARTICLES, EEI)	1.6N			Category 03 SW1	
0487	SIGNALS, SMOKE	1.3G			Category 03 SW1	
0488	AMMUNITION, PRACTICE	1.3G			Category 03 SW1	
0489	DINITROGLYCOLURIL (DINGU)	1.1D			Category 04 SW1	
0490	NITROTRIAZOLONE (NTO)	1.1D			Category 04 SW1	
0491	CHARGES, PROPELLING	1.4C			Category 02 SW1	
0492	SIGNALS, RAILWAY TRACK, EXPLOSIVE	1.3G			Category 03 SW1	
0493	SIGNALS, RAILWAY TRACK, EXPLOSIVE	1.4G			Category 02 SW1	
0494	JET PERFORATING GUNS, CHARGED oil well, without detonator	1.4D			Category 02 SW1	
0495	PROPELLANT, LIQUID	1.3C			Category 04 SW1	
0496	OCTONAL	1.1D			Category 04 SW1	
0497	PROPELLANT, LIQUID	1.1C			Category 04 SW1	
0498	PROPELLANT, SOLID	1.1C			Category 04 SW1	
0499	PROPELLANT, SOLID	1.3C			Category 04 SW1	
0500	DETONATOR ASSEMBLIES, NON-ELECTRIC for blasting	1.4S			Category 01 SW1	
0501	PROPELLANT, SOLID	1.4C			Category 02 SW1	
0502	ROCKETS with inert head	1.2C			Category 04 SW1	
0503	AIR BAG INFLATORS or AIR BAG MODULES or SEAT-BELT PRETENSIONERS	1.4G			Category 02 SW1	
0504	1H-TETRAZOLE	1.1D			Category 04 SW1	
0505	SIGNALS, DISTRESS, ship	1.4G			Category 02 SW1	

UN Number	PROPER SHIPPING NAME (Note: When there is more than one packing group or PSN the UN No. has been annotated with a, b, c)	Class or division	Subsidiary risk(s)	Packing Group	Stowage and Handling	Segregation
0506	SIGNALS, DISTRESS, ship	1.4S			Category 01 SW1	
0507	SIGNALS, SMOKE	1.4S			Category 01 SW1	
0508	1-HYDROXYBENZOTRIAZOLE, ANHYDROUS, dry or wetted with less than 20% water, by mass	1.3C			Category 04 SW1	
0509	POWDER, SMOKELESS	1.4C			Category 02 SW1	
1001	ACETYLENE, DISSOLVED	2.1			Category D SW1 SW2	SG46
1002	AIR, COMPRESSED	2.2			Category A	
1003	AIR, REFRIGERATED LIQUID	2.2	5.1		Category D	
1005	AMMONIA, ANHYDROUS	2.3	8		Category D SW2	SG35 SG46
1006	ARGON, COMPRESSED	2.2			Category A	
1008	BORON TRIFLUORIDE	2.3	8		Category D SW2	
1009	BROMOTRIFLUOROMETHANE (REFRIGERANT GAS R 13B1)	2.2			Category A	
1010	BUTADIENES, STABILIZED or BUTADIENES AND HYDROCARBON MIXTURE, STABILIZED with more than 40% butadienes	2.1			Category B SW2	
1011	BUTANE	2.1			Category E SW2	
1012	BUTYLENE	2.1			Category E SW2	
1013	CARBON DIOXIDE	2.2			Category A	
1016	CARBON MONOXIDE, COMPRESSED	2.3	2.1		Category D SW2	
1017	CHLORINE	2.3	5.1/8 P		Category D SW2	SG6 SG19
1018	CHLORODIFLUOROMETHANE (REFRIGERANT GAS R 22)	2.2			Category A	
1020	CHLOROPENTAFLUOROETHANE (REFRIGERANT GAS R 115)	2.2			Category A	
1021	1-CHLORO-1,2,2,2-TETRAFLUOROETHANE (REFRIGERANT GAS R 124)	2.2			Category A	
1022	CHLOROTRIFLUOROMETHANE (REFRIGERANT GAS R 13)	2.2			Category A	
1023	COAL GAS, COMPRESSED	2.3	2.1		Category D SW2	
1026	CYANOGEN	2.3	2.1		Category D SW2	
1027	CYCLOPROPANE	2.1			Category E SW2	
1028	DICHLORODIFLUOROMETHANE (REFRIGERANT GAS R 12)	2.2			Category A	
1029	DICHLOROFLUOROMETHANE (REFRIGERANT GAS R 21)	2.2			Category A	
1030	1,1-DIFLUOROETHANE (REFRIGERANT GAS R 152a)	2.1			Category B SW2	
1032	DIMETHYLAMINE, ANHYDROUS	2.1			Category D SW2	
1033	DIMETHYL ETHER	2.1			Category B SW2	
1035	ETHANE	2.1			Category E SW2	

UN Number	PROPER SHIPPING NAME (Note: When there is more than one packing group or PSN the UN No. has been annotated with a, b, c)	Class or division	Subsidiary risk(s)	Packing Group	Stowage and Handling	Segregation
1036	ETHYLAMINE	2.1			Category D SW2	
1037	ETHYL CHLORIDE	2.1			Category B SW2	
1038	ETHYLENE, REFRIGERATED LIQUID	2.1			Category D SW2	
1039	ETHYL METHYL ETHER	2.1			Category B SW2	
1040	ETHYLENE OXIDE or ETHYLENE OXIDE WITH NITROGEN up to a total pressure of 1MPa (10 bar) at 50°C	2.3	2.1		Category D SW2	
1041	ETHYLENE OXIDE AND CARBON DIOXIDE MIXTURE with more than 9% but not more than 87% ethyle	2.1			Category B SW2	
1043	FERTILIZER AMMONIATING SOLUTION with free ammonia	2.2			Category E SW2	
1044	FIRE EXTINGUISHERS with compressed or liquefied gas	2.2			Category A	
1045	FLUORINE, COMPRESSED	2.3	5.1/8		Category D SW2	SG6 SG19
1046	HELIUM, COMPRESSED	2.2			Category A	
1048	HYDROGEN BROMIDE, ANHYDROUS	2.3	8		Category D SW2	
1049	HYDROGEN, COMPRESSED	2.1			Category E SW2	SG46
1050	HYDROGEN CHLORIDE, ANHYDROUS	2.3	8		Category D SW2	
1051	HYDROGEN CYANIDE, STABILIZED containing less than 3% water	6.1	3P	I	Category D SW2	
1052	HYDROGEN FLUORIDE, ANHYDROUS	8	6.1	I	Category D SW2	
1053	HYDROGEN SULPHIDE	2.3	2.1		Category D SW2	
1055	ISOBUTYLENE	2.1			Category E SW2	
1056	KRYPTON, COMPRESSED	2.2			Category A	
1057	LIGHTERS or LIGHTER REFILLS containing flammable gas	2.1			Category B SW2	
1058	LIQUEFIED GASES non-flammable, charged with nitrogen, carbon dioxide or air	2.2			Category A	
1060	METHYLACETYLENE AND PROPADIENE MIXTURE, STABILIZED	2.1			Category B SW2	
1061	METHYLAMINE, ANHYDROUS	2.1			Category B SW2	
1062	METHYL BROMIDE with not more than 2.0% chloropicrin	2.3			Category D SW2	
1063	METHYL CHLORIDE (REFRIGERANT GAS R 40)	2.1			Category D SW2	
1064	METHYL MERCAPTAN	2.3	2.1 P		Category D SW2	
1065	NEON, COMPRESSED	2.2			Category A	
1066	NITROGEN, COMPRESSED	2.2			Category A	
1067	DINITROGEN TETROXIDE (NITROGEN DIOXIDE)	2.3	5.1/8		Category D SW2	SG6 SG19
1069	NITROSYL CHLORIDE	2.3	8		Category D SW2	

UN Number	PROPER SHIPPING NAME (Note: When there is more than one packing group or PSN the UN No. has been annotated with a, b, c)	Class or division	Subsidiary risk(s)	Packing Group	Stowage and Handling	Segregation
1070	NITROUS OXIDE	2.2	5.1		Category A SW2	
1071	OIL GAS, COMPRESSED	2.3	2.1		Category D SW2	
1072	OXYGEN, COMPRESSED	2.2	5.1		Category A	
1073	OXYGEN, REFRIGERATED LIQUID	2.2	5.1		Category D	
1075	PETROLEUM GASES, LIQUEFIED	2.1			Category E SW2	
1076	PHOSGENE	2.3	8		Category D SW2	
1077	PROPYLENE	2.1			Category E SW2	
1078	REFRIGERANT GAS, N.O.S.	2.2			Category A	
1079	SULPHUR DIOXIDE	2.3	8		Category D SW2	
1080	SULPHUR HEXAFLUORIDE	2.2			Category A	
1081	TETRAFLUOROETHYLENE, STABILIZED	2.1			Category E SW2	
1082	TRIFLUOROCHLOROETHYLENE, STABILIZED	2.3	2.1		Category D SW2	
1083	TRIMETHYLAMINE, ANHYDROUS	2.1			Category B SW2	
1085	VINYL BROMIDE, STABILIZED	2.1			Category B SW2	
1086	VINYL CHLORIDE, STABILIZED	2.1			Category B SW2	
1087	VINYL METHYL ETHER, STABILIZED	2.1			Category B SW2	
1088	ACETAL	3		II	Category E	
1089	ACETALDEHYDE	3		I	Category E	
1090	ACETONE (ACETONE SOLUTIONS)	3		II	Category E	
1091	ACETONE OILS	3		II	Category B	
1092	ACROLEIN, STABILIZED	6.1	3P	I	Category D SW2	
1093	ACRYLONITRILE, STABILIZED	3	6.1	I	Category E SW2	
1098	ALLYL ALCOHOL	6.1	3	I	Category D SW2	
1099	ALLYL BROMIDE	3	6.1 P	I	Category B SW2	
1100	ALLYL CHLORIDE	3	6.1	I	Category E SW2	
1104	AMYL ACETATES	3		III	Category A	
1105	PENTANOLS	3		II	Category B	
1105	PENTANOLS	3		III	Category A	
1106	AMYLAMINES	3	8	II	Category B	
1106	AMYLAMINES	3	8	III	Category A	
1107	AMYL CHLORIDES	3		II	Category B	
1108	1-PENTENE (n-AMYLENE)	3		I	Category E	
1109	AMYL FORMATES	3		III	Category A	
1110	n-AMYL METHYL KETONE	3		III	Category A	

UN Number	PROPER SHIPPING NAME (Note: When there is more than one packing group or PSN the UN No. has been annotated with a, b, c)	Class or division	Subsidiary risk(s)	Packing Group	Stowage and Handling	Segregation
1111	AMYL MERCAPTANS	3		II	Category B	SG50 SG57
1112	AMYL NITRATES	3		III	Category A SW2	
1113	AMYL NITRITE	3		II	Category E SW2	
1114	BENZENE	3		II	Category B SW2	
1120	BUTANOLS	3		II	Category B	
1120	BUTANOLS	3		III	Category A	
1123	BUTYL ACETATES	3		II	Category B	
1123	BUTYL ACETATES	3		III	Category A	
1125	n-BUTYLAMINE	3	8	II	Category B SW2	
1126	1-BROMOBUTANE	3		II	Category B SW2	
1127	CHLOROBUTANES	3		II	Category B	
1128	n-BUTYL FORMATE	3		II	Category B	
1129	BUTYRALDEHYDE	3		II	Category B	
1130	CAMPHOR OIL	3		III	Category A	
1131	CARBON DISULPHIDE	3	6.1	I	Category D SW2	SG63
1133	ADHESIVES containing flammable liquid	3		I	Category E	
1133	ADHESIVES containing flammable liquid	3		II	Category B	
1133	ADHESIVES containing flammable liquid	3		III	Category A	
1134	CHLOROBENZENE	3		III	Category A	
1135	ETHYLENE CHLOROXYDRIN	6.1	3	I	Category D SW2	
1136	COAL TAR DISTILLATES, FLAMMABLE	3		II	Category B	
1136	COAL TAR DISTILLATES, FLAMMABLE	3		III	Category A	
1139	COATING SOLUTION (includes surface treatments or coatings used for industrial purposes such as vehicle under-coating, drum or barrel lining)	3		I	Category E	
1139	COATING SOLUTION (includes surface treatments or coatings used for industrial purposes such as vehicle under-coating, drum or barrel lining)	3		II	Category B	
1139	COATING SOLUTION (includes surface treatments or coatings used for industrial purposes such as vehicle under-coating, drum or barrel lining)	3		III	Category A	
1143	CROTONALDEHYDE or CROTONALDEHYDE, STABILIZED	6.1	3P	I	Category D SW2	
1144	CROTONYLENE	3		I	Category E	
1145	CYCLOHEXANE	3		II	Category E	
1146	CYCLOPENTANE	3		II	Category E	
1147	DECAHYDRONAPHTHALENES	3		III	Category A	
1148	DIACETONE ALCOHOL	3		II	Category B	
1148	DIACETONE ALCOHOL	3		III	Category A	
1149	DIBUTYL ETHERS	3		III	Category A	

UN Number	PROPER SHIPPING NAME (Note: When there is more than one packing group or PSN the UN No. has been annotated with a, b, c)	Class or division	Subsidiary risk(s)	Packing Group	Stowage and Handling	Segregation
1150	1,2-DICHLOROETHYLENE	3		II	Category B	
1152	DICHLOROPENTANES	3		III	Category A	
1153	ETHYLENE GLYCOL DIETHYL ETHER	3		II	Category A	
1153	ETHYLENE GLYCOL DIETHYL ETHER	3		III	Category A	
1154	DIETHYLAMINE	3	8	II	Category E SW2	
1155	DIETHYL ETHER (ETHYL ETHER)	3		I	Category E SW2	
1156	DIETHYL KETONE	3		II	Category B	
1157	DIISOBUTYL KETONE	3		III	Category A	
1158	DIISOPROPYLAMINE	3	8	II	Category B	
1159	DIISOPROPYL ETHER	3		II	Category E SW2	
1160	DIMETHYLAMINE, AQUEOUS SOLUTION	3	8	II	Category B	SG35
1161	DIMETHYL CARBONATE	3		II	Category B	
1162	DIMETHYLDICHLOROSILANE	3	8	II	Category B SW2	
1163	DIMETHYLHYDRAZINE, UNSYMMETRICAL	6.1	3/8P	I	Category D SW2	SG5 SG8 SG13 SG35
1164	DIMETHYL SULPHIDE	3		II	Category E SW2	
1165	DIOXANE	3		II	Category B	
1166	DIOXOLANE	3		II	Category B SW2	
1167	DIVINYL ETHER, STABILIZED	3		I	Category E SW2	
1169	EXTRACTS, AROMATIC, LIQUID	3		II	Category B	
1169	EXTRACTS, AROMATIC, LIQUID	3		III	Category A	
1170	ETHANOL (ETHYL ALCOHOL) or ETHANOL SOLUTION (ETHYL ALCOHOL SOLUTION)	3		II	Category A	
1170	ETHANOL (ETHYL ALCOHOL) or ETHANOL SOLUTION (ETHYL ALCOHOL SOLUTION)	3		III	Category A	
1171	ETHYLENE GLYCOL MONOETHYL ETHER	3		III	Category A	
1172	ETHYLENE GLYCOL MONOETHYL ETHER ACETATE	3		III	Category A	
1173	ETHYL ACETATE	3		II	Category B	
1175	ETHYLBENZENE	3		II	Category B	
1176	ETHYL BORATE	3		II	Category B	
1177	2-ETHYLBUTYL ACETATE	3		III	Category A	
1178	2-ETHYLBUTYRALDEHYDE	3		II	Category B	
1179	ETHYL BUTYL ETHER	3		II	Category B	
1180	ETHYL BUTYRATE	3		III	Category A	
1181	ETHYL CHLOROACETATE	6.1	3	II	Category A	
1182	ETHYL CHLOROFORMATE	6.1	3/8	I	Category D SW2	SG5 SG8
1183	ETHYLDICHLOROSILANE	4.3	3/8	I	Category D SW2	SG5 SG7 SG8 SG13



UN Number	PROPER SHIPPING NAME (Note: When there is more than one packing group or PSN the UN No. has been annotated with a, b, c)	Class or division	Subsidiary risk(s)	Packing Group	Stowage and Handling	Segregation
1184	ETHYLENE DICHLORIDE	3	6.1	II	Category B SW2	
1185	ETHYLENEIMINE, STABILIZED	6.1	3	I	Category D SW2	
1188	ETHYLENE GLYCOL MONOMETHYL ETHER	3		III	Category A	
1189	ETHYLENE GLYCOL MONOMETHYL ETHER ACETATE	3		III	Category A	
1190	ETHYL FORMATE	3		II	Category E	
1191	OCTYL ALDEHYDES	3		III	Category A	
1192	ETHYL LACTATE	3		III	Category A	
1193	ETHYL METHYL KETONE (METHYL ETHYL KETONE)	3		II	Category B	
1194	ETHYL NITRITE SOLUTION	3	6.1	I	Category D SW2	
1195	ETHYL PROPIONATE	3		II	Category B	
1196	ETHYLTRICHLOROSILANE	3	8	II	Category B SW2	
1197	EXTRACTS, FLAVOURING, LIQUID	3		II	Category B	
1197	EXTRACTS, FLAVOURING, LIQUID	3		III	Category A	
1198	FORMALDEHYDE SOLUTION, FLAMMABLE	3	8	III	Category A SW2	
1199	FURALDEHYDES	6.1	3	II	Category A	
1201	FUSEL OIL	3		II	Category B	
1201	FUSEL OIL	3		III	Category A	
1202	GAS OIL or DIESEL FUEL or HEATING OIL, LIGHT	3		III	Category A	
1203	MOTOR SPIRIT or GASOLINE or PETROL	3		II	Category E	
1204	NITROGLYCERIN SOLUTION IN ALCOHOL with not more than 1% nitroglycerin	3		II	Category B	
1206	HEPTANES	3		II	Category B	
1207	HEXALDEHYDE	3		III	Category A	
1208	HEXANES	3		II	Category E	
1210	PRINTING INK flammable or PRINTING INK RELATED MATERIAL (including printing ink thinning or reducing compound), flammable	3		I	Category E	
1210	PRINTING INK flammable or PRINTING INK RELATED MATERIAL (including printing ink thinning or reducing compound), flammable	3		II	Category B	
1210	PRINTING INK flammable or PRINTING INK RELATED MATERIAL (including printing ink thinning or reducing compound), flammable	3		III	Category A	
1212	ISOBUTANOL (ISOBUTYL ALCOHOL)	3		III	Category A	
1213	ISOBUTYL ACETATE	3		II	Category B	
1214	ISOBUTYLAMINE	3	8	II	Category B SW2	
1216	ISOOCETENES	3		II	Category B	
1218	ISOPRENE, STABILIZED	3		I	Category E	
1219	ISOPROPANOL (ISOPROPYL ALCOHOL)	3		II	Category B	
1220	ISOPROPYL ACETATE	3		II	Category B	

UN Number	PROPER SHIPPING NAME (Note: When there is more than one packing group or PSN the UN No. has been annotated with a, b, c)	Class or division	Subsidiary risk(s)	Packing Group	Stowage and Handling	Segregation
1221	ISOPROPYLAMINE	3	8	I	Category E SW2	
1222	ISOPROPYL NITRATE	3		II	Category D	
1223	KEROSENE	3		III	Category A	
1224	KETONES, LIQUID, N.O.S.	3		II	Category B	
1224	KETONES, LIQUID, N.O.S.	3		III	Category A	
1228	MERCAPTANS, LIQUID, FLAMMABLE, TOXIC, N.O.S. or MERCAPTAN MIXTURE, LIQUID, FLAMMABLE, TO	3	6.1	II	Category B SW2	SG50 SG57
1228	MERCAPTANS, LIQUID, FLAMMABLE, TOXIC, N.O.S. or MERCAPTAN MIXTURE, LIQUID, FLAMMABLE, N.O.S	3	6.1	III	Category B SW2	SG50 SG57
1229	MESITYL OXIDE	3		III	Category A	
1230	METHANOL	3	6.1	II	Category B SW2	
1231	METHYL ACETATE	3		II	Category B	
1233	METHYLAMYL ACETATE	3		III	Category A	
1234	METHYLAL	3		II	Category E	
1235	METHYLAMINE, AQUEOUS SOLUTION	3		II	Category E	SG35 SG54
1237	METHYL BUTYRATE	3		II	Category B	
1238	METHYL CHLOROFORMATE	6.1	*3/8	I	Category D SW2	SG5 SG8
1239	METHYL CHLOROMETHYL ETHER	6.1	3	I	Category D SW2	
1242	METHYLDICHLOROSILANE	4.3	*3/8	I	Category D SW2	SG5 SG7 SG8 SG13
1243	METHYL FORMATE	3		I	Category E	
1244	METHYLHYDRAZINE	6.1	*3/8	I	Category D SW2	SG5 SG8 SG13 SG35
1245	METHYL ISOBUTYL KETONE	3		II	Category B	
1246	METHYL ISOPROPENYL KETONE, STABILIZED	3		II	Category B	
1247	METHYL METHACRYLATE MONOMER, STABILIZED	3		II	Category B SW2	
1248	METHYL PROPIONATE	3		II	Category B	
1249	METHYL PROPYL KETONE	3		II	Category B	
1250	METHYLTRICHLOROSILANE	3	8	II	Category B SW2	
1251	METHYL VINYL KETONE, STABILIZED	6.1	*3/8	I	Category D SW2	SG5 SG8
1259	NICKEL CARBONYL	6.1	3P	I	Category D SW2	SG63
1261	NITROMETHANE	3		II	Category A	
1262	OCTANES	3		II	Category B	
1263	PAINT (including paint, lacquer, enamel, stain, shellac solutions, varnish, polish, liquid filler and liquid lacquer base) or PAINT RELATED MATERIAL (including paint thinning or reducing compound)	3		I	Category E	

UN Number	PROPER SHIPPING NAME (Note: When there is more than one packing group or PSN the UN No. has been annotated with a, b, c.)	Class or division	Subsidiary risk(s)	Packing Group	Stowage and Handling	Segregation
1263	PAINT (including paint, lacquer, enamel, stain, shellac solutions, varnish, polish, liquid filler and liquid lacquer base) or PAINT RELATED MATERIAL (including paint thinning or reducing compound)	3		II	Category B	
1263	PAINT (including paint, lacquer, enamel, stain, shellac solutions, varnish, polish, liquid filler and liquid lacquer base) or PAINT RELATED MATERIAL (including paint thinning or reducing compound)	3		III	Category A	
1264	PARALDEHYDE	3		III	Category A	
1265	PENTANES, liquid	3		I	Category E	
1265	PENTANES, liquid	3		II	Category E	
1266	PERFUMERY PRODUCTS with flammable solvents	3		II	Category B	
1266	PERFUMERY PRODUCTS with flammable solvents	3		III	Category A	
1267	PETROLEUM CRUDE OIL	3		I	Category E	
1267	PETROLEUM CRUDE OIL	3		II	Category B	
1267	PETROLEUM CRUDE OIL	3		III	Category A	
1268	PETROLEUM DISTILLATES, N.O.S. or PETROLEUM PRODUCTS, N.O.S.	3		I	Category E	
1268	PETROLEUM DISTILLATES, N.O.S. or PETROLEUM PRODUCTS, N.O.S.	3		II	Category B	
1268	PETROLEUM DISTILLATES, N.O.S. or PETROLEUM PRODUCTS, N.O.S.	3		III	Category A	
1272	PINE OIL	3		III	Category A	
1274	n-PROPANOL (PROPYL ALCOHOL, NORMAL)	3		II	Category B	
1274	n-PROPANOL (PROPYL ALCOHOL, NORMAL)	3		III	Category A	
1275	PROPIONALDEHYDE	3		II	Category E	
1276	n-PROPYL ACETATE	3		II	Category B	
1277	PROPYLAMINE	3	8	II	Category E SW2	
1278	1-CHLOROPROPANE	3		II	Category E	
1279	1,2-DICHLOROPROPANE	3		II	Category B	
1280	PROPYLENE OXIDE	3		I	Category E SW2	
1281	PROPYL FORMATES	3		II	Category B	
1282	PYRIDINE	3		II	Category B SW2	
1286	ROSIN OIL	3		II	Category B	
1286	ROSIN OIL	3		III	Category A	
1287	RUBBER SOLUTION	3		II	Category B	
1287	RUBBER SOLUTION	3		III	Category A	
1288	SHALE OIL	3		II	Category B	
1288	SHALE OIL	3		III	Category A	
1289	SODIUM METHYLATE SOLUTION in alcohol	3	8	II	Category B	
1289	SODIUM METHYLATE SOLUTION in alcohol	3	8	III	Category A	
1292	TETRAETHYL SILICATE	3		III	Category A	
1293	TINCTURES, MEDICINAL	3		II	Category B	

UN Number	PROPER SHIPPING NAME (Note: When there is more than one packing group or PSN the UN No. has been annotated with a, b, c)	Class or division	Subsidiary risk(s)	Packing Group	Stowage and Handling	Segregation
1293	TINCTURES, MEDICINAL	3		III	Category A	
1294	TOLUENE	3		II	Category B	
1295	TRICHLOROSILANE	4.3	*8/3	I	Category D SW2	SG5 SG7 SG8 SG13 SG72
1296	TRIETHYLAMINE	3	8	II	Category B SW2	
1297	TRIMETHYLAMINE, AQUEOUS SOLUTION not more than 50% trimethylamine, by mass	3	8	I	Category D SW2	SG54
1297	TRIMETHYLAMINE, AQUEOUS SOLUTION not more than 50% trimethylamine, by mass	3	8	II	Category B SW2	SG54
1297	TRIMETHYLAMINE, AQUEOUS SOLUTION not more than 50% trimethylamine, by mass	3	8	III	Category A SW2	SG54
1298	TRIMETHYLCHLOROSILANE	3	8	II	Category E SW2	
1299	TURPENTINE	3		III	Category A	
1300	TURPENTINE SUBSTITUTE	3		II	Category B	
1300	TURPENTINE SUBSTITUTE	3		III	Category A	
1301	VINYL ACETATE, STABILIZED	3		II	Category B	
1302	VINYL ETHYL ETHER, STABILIZED	3		I	Category D	
1303	VINYLDENE CHLORIDE, STABILIZED	3	P	I	Category E SW2	
1304	VINYL ISOBUTYL ETHER, STABILIZED	3		II	Category B	
1305	VINYLTRICHLOROSILANE	3	8	II	Category B SW2	
1306	WOOD PRESERVATIVES, LIQUID	3		II	Category B	
1306	WOOD PRESERVATIVES, LIQUID	3		III	Category A	
1307	XYLENES	3		II	Category B	
1307	XYLENES	3		III	Category A	
1308	ZIRCONIUM, SUSPENDED IN A FLAMMABLE LIQUID	3		I	Category D	
1308	ZIRCONIUM, SUSPENDED IN A FLAMMABLE LIQUID	3		II	Category B	
1308	ZIRCONIUM, SUSPENDED IN A FLAMMABLE LIQUID	3		III	Category B	
1309	ALUMINIUM POWDER, COATED	4.1		II	Category A H1	SG17 SG32 SG35 SG36 SG52
1309	ALUMINIUM POWDER, COATED	4.1		III	Category A H1	SG17 SG32 SG35 SG36 SG52
1310	AMMONIUM PICRATE, WETTED with not less than 10% water, by mass	4.1		I	Category D	SG7 SG30
1312	BORNEOL	4.1		III	Category A	
1313	CALCIUM RESINATE	4.1		III	Category A	
1314	CALCIUM RESINATE, FUSED	4.1		III	Category A	
1318	COBALT RESINATE, PRECIPITATED	4.1		III	Category A	
1320	DINITROPHENOL, WETTED with not less than 15% water, by mass	4.1		I	Category E	SG7 SG30

UN Number	PROPER SHIPPING NAME (Note: When there is more than one packing group or PSN the UN No. has been annotated with a, b, c.)	Class or division	Subsidiary risk(s)	Packing Group	Stowage and Handling	Segregation
1321	DINITROPHENOLATES, WETTED with not less than 15% water, by mass	4.1	6.1P	I	Category E	SG7 SG30
1322	DINITRORESORCINOL, WETTED with not less than 15% water, by mass	4.1		I	Category E	SG7 SG30
1323	FERROCERIUM	4.1		II	Category A	
1324	FILMS, NITROCELLULOSE BASE gelatin coated, except scrap	4.1		III	Category D	SG7
1325	FLAMMABLE SOLID, ORGANIC, N.O.S.	4.1		II	Category B	
1325	FLAMMABLE SOLID, ORGANIC, N.O.S.	4.1		III	Category B	
1326	HAFNIUM POWDER, WETTED with not less than 25% water (a visible excess of water must be present) (a) mechanically produced, particle size less than 53 microns; (b) chemically produced, particle size less than 840 microns	4.1		II	Category E	SG17
1327	HAY, STRAW or BHUSA	4.1			Category A SW10	SG23
1328	HEXAMETHYLENETETRAMINE	4.1		III	Category A	
1330	MANGANESE RESINATE	4.1		III	Category A	
1331	MATCHES, 'STRIKE ANYWHERE'	4.1		III	Category B	
1332	METALDEHYDE	4.1		III	Category A	
1333	CERIUM slabs, ingots or rods	4.1		II	Category A	SG15 SG17
1334	NAPHTHALENE, CRUDE or NAPHTHALENE, REFINED	4.1		III	Category A SW23	
1336	NITROGUANIDINE (PICRITE), WETTED with not less than 20% water, by mass	4.1		I	Category E	SG7 SG30
1337	NITROSTARCH, WETTED with not less than 20% water, by mass	4.1		I	Category D	SG7 SG30
1338	PHOSPHORUS, AMORPHOUS	4.1		III	Category A	SG17
1339	PHOSPHORUS HEPTASULPHIDE free from yellow or white phosphorus	4.1		II	Category B	SG17
1340	PHOSPHORUS PENTASULPHIDE free from yellow or white phosphorus	4.3		II	Category D	
1341	PHOSPHORUS SESQUISULPHIDE free from yellow or white phosphorus	4.1		II	Category B	SG17
1343	PHOSPHORUS TRISULPHIDE free from yellow or white phosphorus	4.1		II	Category B	SG17
1344	TRINITROPHENOL (PICRIC ACID), WETTED with not less than 30% water, by mass	4.1		I	Category E	SG7 SG30
1345	RUBBER SCRAP powdered or granulated, not exceeding 840 microns and rubber content exceeding 45% or RUBBER SHODDY powdered or granulated, not exceeding 840 microns and rubber content exceeding 45%	4.1		II	Category A	
1346	SILICON POWDER, AMORPHOUS	4.1		III	Category A	SG17
1347	SILVER PICRATE, WETTED with not less than 30% water, by mass	4.1		I	Category D	SG7 SG30
1348	SODIUM DINITRO-o-CRESOLATE, WETTED with not less than 15% water, by mass	4.1	6.1P	I	Category E	SG7 SG30
1349	SODIUM PICRAMATE, WETTED with not less than 20% water, by mass	4.1		I	Category E	SG7 SG30

UN Number	PROPER SHIPPING NAME (Note: When there is more than one packing group or PSN the UN No. has been annotated with a, b, c)	Class or division	Subsidiary risk(s)	Packing Group	Stowage and Handling	Segregation
1350	SULPHUR	4.1		III	Category A SW1 SW23	SG17
1352	TITANIUM POWDER, WETTED with not less than 25% water (a visible excess of water must be present) (a) mechanically produced, particle size less than 53 microns; (b) chemically produced, particle size less than 840 microns	4.1		II	Category E	SG17
1353	FIBRES or FABRICS IMPREGNATED WITH WEAKLY NITRATED NITROCELLULOSE, N.O.S.	4.1		III	Category D	
1354	TRINITROBENZENE, WETTED with not less than 30% water, by mass	4.1		I	Category E	SG7 SG30
1355	TRINITROBENZOIC ACID, WETTED with not less than 30% water, by mass	4.1		I	Category E	SG7 SG30
1356	TRINITROTOLUENE (TNT), WETTED with not less than 30% water, by mass	4.1		I	Category E	SG7 SG30
1357	UREA NITRATE, WETTED with not less than 20% water, by mass	4.1		I	Category E	SG7 SG30
1358	ZIRCONIUM POWDER, WETTED with not less than 25% water (a visible excess of water must be present) (a) mechanically produced, particle size less than 53 microns; (b) chemically produced, particle size less than 840 microns	4.1		II	Category E	SG17
1360	CALCIUM PHOSPHIDE	4.3	6.1	I	Category E SW2 SW5	SG35
1361	CARBON animal or vegetable origin	4.2		II	Category A SW1 H2	
1361	CARBON animal or vegetable origin	4.2		III	Category A SW1 H2	
1362	CARBON, ACTIVATED	4.2		III	Category A SW1 H2	
1363	COPRA	4.2		III	Category A SW1 SW9 H1	
1364	COTTON WASTE, OILY	4.2		III	Category A	SG41
1365	COTTON, WET	4.2		III	Category A	
1369	p-NITROSODIMETHYLANILINE	4.2		II	Category D	SG29
1372	FIBRES ANIMAL or FIBRES VEGETABLE burnt, wet or damp	4.2		III	Category A	
1373	FIBRES or FABRICS, ANIMAL or VEGETABLE or SYNTHETIC N.O.S. with oil	4.2		III	Category A	
1374	FISHMEAL, UNSTABILIZED (FISHSCRAP, UNSTABILIZED) High hazard. Unrestricted moisture content, Unrestricted fat content in excess of 12%, by mass; unrestricted fat content in excess of 15%, by mass, in the case of antioxidant treated fishmeal or fishscrap	4.2		II	Category B SW1 SW24	SG65
1374	FISHMEAL, UNSTABILIZED (FISHSCRAP, UNSTABILIZED) High hazard Unrestricted moisture content, Unrestricted fat content in excess of 12%, by mass; unrestricted fat content in excess of 15%, by mass, in the case of antioxidant treated fishmeal or fishscrap	4.2		III	Category A SW1 SW24	
1376	IRON OXIDE, SPENT or IRON SPONGE, SPENT obtained from coal gas purification	4.2		III	Category E	

UN Number	PROPER SHIPPING NAME (Note: When there is more than one packing group or PSN the UN No. has been annotated with a, b, c)	Class or division	Subsidiary risk(s)	Packing Group	Stowage and Handling	Segregation
1378	METAL CATALYST, WETTED with a visible excess of liquid	4.2		II	Category C	
1379	PAPER, UNSATURATED OIL TREATED incompletely dried (including carbon paper)	4.2		III	Category A	
1380	PENTABORANE	4.2	6.1	I	Category D	
1381	PHOSPHORUS, WHITE or YELLOW, DRY or UNDER WATER or IN SOLUTION	4.2	6.1P	I	Category E	
1382	POTASSIUM SULPHIDE, ANHYDROUS or POTASSIUM SULPHIDE with less than 30% water of crystal	4.2		II	Category A	SG35
1383	PYROPHORIC METAL, N.O.S. or PYROPHORIC ALLOY, N.O.S.	4.2		I	Category D	
1384	SODIUM DITHIONITE (SODIUM HYDROSULPHITE)	4.2		II	Category E H1	
1385	SODIUM SULPHIDE, ANHYDROUS or SODIUM SULPHIDE with less than 30% water of crystallization	4.2		II	Category A	SG35
1386	SEED CAKE, containing vegetable oil (a) mechanically expelled seeds, containing more than	4.2		III	Category E SW1 SW25 H1	
1386	SEED CAKE, containing vegetable oil (b) solvent extractions and expelled seeds, containing	4.2		III	Category A SW1 SW25 H1	
1387	WOOL WASTE, WET	4.2		III	Category A	
1389	ALKALI METAL AMALGAM, LIQUID	4.3		I	Category D	SG35
1390	ALKALI METAL AMIDE	4.3		II	Category E SW2	SG35
1391	ALKALI METAL DISPERSION or ALKALINE EARTH METAL DISPERSION	4.3		I	Category D	SG35
1392	ALKALINE EARTH METAL AMALGAM, LIQUID	4.3		I	Category D	SG35
1393	ALKALINE EARTH METAL ALLOY, N.O.S.	4.3		II	Category E	SG35
1394	ALUMINIUM CARBIDE	4.3		II	Category A	SG35
1395	ALUMINIUM FERROSILICON POWDER	4.3	6.1	II	Category A SW2 SW5 H1	SG32 SG35 SG36
1396	ALUMINIUM POWDER, UNCOATED	4.3		II	Category A	SG32 SG35 SG36
1396	ALUMINIUM POWDER, UNCOATED	4.3		III	Category A	SG32 SG35 SG36
1397	ALUMINIUM PHOSPHIDE	4.3	6.1	I	Category E SW2 SW5	SG35
1398	ALUMINIUM SILICON POWDER, UNCOATED	4.3		III	Category A SW2 SW5 H1	SG32 SG35 SG36
1400	BARIUM	4.3		II	Category E	SG35
1401	CALCIUM	4.3		II	Category E	SG35
1402	CALCIUM CARBIDE	4.3		I	Category B	SG35
1402	CALCIUM CARBIDE	4.3		II	Category B	SG35
1403	CALCIUM CYANAMIDE with more than 0.1% calcium carbide	4.3		III	Category A	SG35
1404	CALCIUM HYDRIDE	4.3		I	Category E	SG35
1405	CALCIUM SILICIDE	4.3		II	Category B SW5 H1	SG35
1405	CALCIUM SILICIDE	4.3		III	Category B SW5 H1	SG35

UN Number	PROPER SHIPPING NAME (Note: When there is more than one packing group or PSN the UN No. has been annotated with a, b, c)	Class or division	Subsidiary risk(s)	Packing Group	Stowage and Handling	Segregation
1407	CAESIUM	4.3		I	Category D	SG35
1408	FERROSILICON with 30% or more but less than 90% silicon	4.3	6.1	III	Category A SW2 SW5 H1	SG35 SG36
1409	METAL HYDRIDES, WATER-REACTIVE, N.O.S.	4.3		I	Category D	SG35
1409	METAL HYDRIDES, WATER-REACTIVE, N.O.S.	4.3		II	Category D	SG35
1410	LITHIUM ALUMINIUM HYDRIDE	4.3		I	Category E	SG35
1411	LITHIUM ALUMINIUM HYDRIDE, ETHEREAL	4.3	3	I	Category D SW2	
1413	LITHIUM BOROHYDRIDE	4.3		I	Category E	SG35
1414	LITHIUM HYDRIDE	4.3		I	Category E	SG35
1415	LITHIUM	4.3		I	Category E	SG35
1417	LITHIUM SILICON	4.3		II	Category A SW5 H1	
1418	MAGNESIUM POWDER or MAGNESIUM ALLOYS POWDER	4.3	4.2	I	Category A	SG32 SG35
1418	MAGNESIUM POWDER or MAGNESIUM ALLOYS POWDER	4.3	4.2	II	Category A	SG32 SG35
1418	MAGNESIUM POWDER or MAGNESIUM ALLOYS POWDER	4.3	4.2	III	Category A	SG32 SG35
1419	MAGNESIUM ALUMINIUM PHOSPHIDE	4.3	6.1	I	Category E SW2 SW5	SG35
1420	POTASSIUM METAL ALLOYS, LIQUID	4.3		I	Category D	SG35
1421	ALKALI METAL ALLOY, LIQUID, N.O.S.	4.3		I	Category D	SG35
1422	POTASSIUM SODIUM ALLOYS, LIQUID	4.3		I	Category D	SG35
1423	RUBIDIUM	4.3		I	Category D	SG35
1426	SODIUM BOROHYDRIDE	4.3		I	Category E	SG35
1427	SODIUM HYDRIDE	4.3		I	Category E	SG35
1428	SODIUM	4.3		I	Category D	SG35
1431	SODIUM METHYLATE	4.2	8	II	Category B	
1432	SODIUM PHOSPHIDE	4.3	6.1	I	Category E SW2 SW5	SG35
1433	STANNIC PHOSPHIDE	4.3	6.1	I	Category E SW2 SW5	SG35
1435	ZINC ASHES	4.3		III	Category A	
1436	ZINC POWDER or ZINC DUST	4.3	4.2	I	Category A	SG35 SG36
1436	ZINC POWDER or ZINC DUST	4.3	4.2	II	Category A	SG35 SG36
1436	ZINC POWDER or ZINC DUST	4.3	4.2	III	Category A	SG35 SG36
1437	ZIRCONIUM HYDRIDE	4.1		II	Category E	
1438	ALUMINIUM NITRATE	5.1		III	Category A	
1439	AMMONIUM DICHROMATE	5.1		II	Category A	SG35
1442	AMMONIUM PERCHLORATE	5.1		II	Category E	SG49 SG60
1444	AMMONIUM PERSULPHATE	5.1		III	Category A	



UN Number	PROPER SHIPPING NAME (Note: When there is more than one packing group or PSN the UN No. has been annotated with a, b, c)	Class or division	Subsidiary risk(s)	Packing Group	Stowage and Handling	Segregation
1445	BARIUM CHLORATE, SOLID	5.1	6.1	II	Category A	SG38 SG49
1446	BARIUM NITRATE	5.1	6.1	II	Category A	
1447	BARIUM PERCHLORATE, SOLID	5.1	6.1	II	Category A	SG38 SG49
1448	BARIUM PERMANGANATE	5.1	6.1	II	Category D	SG38 SG49 SG60
1449	BARIUM PEROXIDE	5.1	6.1	II	Category A H1	SG16 SG35 SG59
1450	BROMATES, INORGANIC, N.O.S.	5.1		II	Category A	SG38 SG49
1451	CAESIUM NITRATE	5.1		III	Category A	
1452	CALCIUM CHLORATE	5.1		II	Category A	SG38 SG49
1453	CALCIUM CHLORITE	5.1		II	Category A	SG38 SG49
1454	CALCIUM NITRATE	5.1		III	Category A SW23	
1455	CALCIUM PERCHLORATE	5.1		II	Category A	SG38 SG49
1456	CALCIUM PERMANGANATE	5.1		II	Category D	SG38 SG49 SG60
1457	CALCIUM PEROXIDE	5.1		II	Category A H1	SG16 SG35 SG59
1458	CHLORATE AND BORATE MIXTURE	5.1		II	Category A	SG38 SG49
1458	CHLORATE AND BORATE MIXTURE	5.1		III	Category A	SG38 SG49
1459	CHLORATE AND MAGNESIUM CHLORIDE MIXTURE, SOLID	5.1		II	Category A	SG38 SG49
1459	CHLORATE AND MAGNESIUM CHLORIDE MIXTURE, SOLID	5.1		III	Category A	SG38 SG49
1461	CHLORATES, INORGANIC, N.O.S.	5.1		II	Category A	SG38 SG49
1462	CHLORITES, INORGANIC, N.O.S.	5.1		II	Category A	SG38 SG49
1463	CHROMIUM TRIOXIDE, ANHYDROUS	5.1	6.1/8	II	Category A	SG6 SG16 SG19
1465	DIDYMIUM NITRATE	5.1		III	Category A	
1466	FERRIC NITRATE	5.1		III	Category A	
1467	GUANIDINE NITRATE	5.1		III	Category A	SG45
1469	LEAD NITRATE	5.1	6.1P	II	Category A	
1470	LEAD PERCHLORATE, SOLID	5.1	6.1P	II	Category A	SG38 SG49
1471	LITHIUM HYPOCHLORITE, DRY or LITHIUM HYPOCHLORITE MIXTURE	5.1		II	Category A SW1 SW8	SG35 SG38 SG49 SG53 SG60

UN Number	PROPER SHIPPING NAME (Note: When there is more than one packing group or PSN the UN No. has been annotated with a, b, c)	Class or division	Subsidiary risk(s)	Packing Group	Stowage and Handling	Segregation
1471	LITHIUM HYPOCHLORITE, DRY or LITHIUM HYPOCHLORITE MIXTURE	5.1		III	Category A SW1 SW8	SG35 SG38 SG49 SG53 SG60
1472	LITHIUM PEROXIDE	5.1		II	Category A H1	SG16 SG35 SG59
1473	MAGNESIUM BROMATE	5.1		II	Category A	SG38 SG49
1474	MAGNESIUM NITRATE	5.1		III	Category A SW23	
1475	MAGNESIUM PERCHLORATE	5.1		II	Category A	SG38 SG49
1476	MAGNESIUM PEROXIDE	5.1		II	Category A H1	SG16 SG35 SG59
1477	NITRATES, INORGANIC, N.O.S.	5.1		II	Category A	SG38 SG49
1477	NITRATES, INORGANIC, N.O.S.	5.1		III	Category A	SG38 SG49
1479	OXIDIZING SOLID, N.O.S.	5.1		I	Category D	SG38 SG49 SG60 SG61
1479	OXIDIZING SOLID, N.O.S.	5.1		II	Category B	SG38 SG49 SG60 SG61
1479	OXIDIZING SOLID, N.O.S.	5.1		III	Category B	SG38 SG49 SG60 SG61
1481	PERCHLORATES, INORGANIC, N.O.S.	5.1		II	Category A	SG38 SG49
1481	PERCHLORATES, INORGANIC, N.O.S.	5.1		III	Category A	SG38 SG49
1482	PERMANGANATES, INORGANIC, N.O.S.	5.1		II	Category D	SG38 SG49 SG60
1482	PERMANGANATES, INORGANIC, N.O.S.	5.1		III	Category D	SG38 SG49 SG60
1483	PEROXIDES, INORGANIC, N.O.S.	5.1		II	Category A H1	SG16 SG35 SG59
1483	PEROXIDES, INORGANIC, N.O.S.	5.1		III	Category A H1	SG16 SG35 SG59
1484	POTASSIUM BROMATE	5.1		II	Category A	SG38 SG49
1485	POTASSIUM CHLORATE	5.1		II	Category A	SG38 SG49
1486	POTASSIUM NITRATE	5.1		III	Category A SW23	
1487	POTASSIUM NITRATE AND SODIUM NITRITE MIXTURE	5.1		II	Category A	SG38 SG49
1488	POTASSIUM NITRITE	5.1		II	Category A	SG38 SG49
1489	POTASSIUM PERCHLORATE	5.1		II	Category A	SG38 SG49

UN Number	PROPER SHIPPING NAME (Note: When there is more than one packing group or PSN the UN No. has been annotated with a, b, c.)	Class or division	Subsidiary risk(s)	Packing Group	Stowage and Handling	Segregation
1490	POTASSIUM PERMANGANATE	5.1		II	Category D	SG38 SG49 SG60
1491	POTASSIUM PEROXIDE	5.1		I	Category B H1	SG16 SG35 SG59
1492	POTASSIUM PERSULPHATE	5.1		III	Category A	SG39 SG49
1493	SILVER NITRATE	5.1		II	Category A	
1494	SODIUM BROMATE	5.1		II	Category A	SG38 SG49
1495	SODIUM CHLORATE	5.1		II	Category A	SG38 SG49
1496	SODIUM CHLORITE	5.1		II	Category A	SG38 SG49
1498	SODIUM NITRATE	5.1		III	Category A SW23	
1499	SODIUM NITRATE AND POTASSIUM NITRATE MIXTURE	5.1		III	Category A SW23	
1500	SODIUM NITRITE	5.1	6.1	III	Category A	SG38 SG49
1502	SODIUM PERCHLORATE	5.1		II	Category A	SG38 SG49
1503	SODIUM PERMANGANATE	5.1		II	Category D	SG38 SG49 SG60
1504	SODIUM PEROXIDE	5.1		I	Category B H1	SG16 SG35 SG59
1505	SODIUM PERSULPHATE	5.1		III	Category A	SG39 SG49
1506	STRONTIUM CHLORATE	5.1		II	Category A	SG38 SG49
1507	STRONTIUM NITRATE	5.1		III	Category A	
1508	STRONTIUM PERCHLORATE	5.1		II	Category A	SG38 SG49
1509	STRONTIUM PEROXIDE	5.1		II	Category A H1	SG16 SG35 SG59
1510	TETRANITROMETHANE	6.1	5.1	I	Category D SW2	SG16
1511	UREA HYDROGEN PEROXIDE	5.1	8	III	Category A H1	
1512	ZINC AMMONIUM NITRITE	5.1			Category	
1513	ZINC CHLORATE	5.1		II	Category A	SG38 SG49
1514	ZINC NITRATE	5.1		II	Category A	
1515	ZINC PERMANGANATE	5.1		II	Category D	SG38 SG49 SG60
1516	ZINC PEROXIDE	5.1		II	Category A H1	SG16 SG35 SG59
1517	ZIRCONIUM PICRAMATE, WETTED with not less than 20% water, by mass	4.1		I	Category D	SG7 SG30
1541	ACETONE CYANOHYDRIN, STABILIZED	6.1	P	I	Category D SW1 SW2	SG35 SG36

UN Number	PROPER SHIPPING NAME (Note: When there is more than one packing group or PSN the UN No. has been annotated with a, b, c)	Class or division	Subsidiary risk(s)	Packing Group	Stowage and Handling	Segregation
1544	ALKALOIDS, SOLID, N.O.S. or ALKALOIDS SALTS, SOLID, N.O.S.	6.1		I	Category A	
1544	ALKALOIDS, SOLID, N.O.S. or ALKALOIDS SALTS, SOLID, N.O.S.	6.1		II	Category A	
1544	ALKALOIDS, SOLID, N.O.S. or ALKALOIDS SALTS, SOLID, N.O.S.	6.1		III	Category A	
1545	ALLYL ISOTHIOCYANATE, STABILIZED	6.1	3	II	Category D SW2	
1546	AMMONIUM ARSENATE	6.1		II	Category A	SG36
1547	ANILINE	6.1		II	Category A SW2	SG35
1548	ANILINE HYDROCHLORIDE	6.1		III	Category A	
1549	ANTIMONY COMPOUND, INORGANIC, SOLID, N.O.S.	6.1		III	Category A	
1550	ANTIMONY LACTATE	6.1		III	Category A	
1551	ANTIMONY POTASSIUM TARTRATE	6.1		III	Category A	
1553	ARSENIC ACID, LIQUID	6.1		I	Category B	SG33
1554	ARSENIC ACID, SOLID	6.1		II	Category A	
1555	ARSENIC BROMIDE	6.1		II	Category A SW1 SW2 H2	
1556	ARSENIC COMPOUND, LIQUID, N.O.S. inorganic, including: Arsenates, n.o.s., Arsenites, n.o.s., and Arsenic sulphides, n.o.s.	6.1		I	Category B SW2	SG70
1556	ARSENIC COMPOUND, LIQUID, N.O.S. inorganic, including: Arsenates, n.o.s., Arsenites, n.o.s., and Arsenic sulphides, n.o.s.	6.1		II	Category B SW2	SG70
1556	ARSENIC COMPOUND, LIQUID, N.O.S. inorganic, including: Arsenates, n.o.s., Arsenites, n.o.s., and Arsenic sulphides, n.o.s.	6.1		III	Category B SW2	SG70
1557	ARSENIC COMPOUND, SOLID, N.O.S. inorganic, including: Arsenates, n.o.s.; Arsenites, n.o.s.; and Arsenic sulphides, n.o.s.	6.1		I	Category A	SG70
1557	ARSENIC COMPOUND, SOLID, N.O.S. inorganic, including: Arsenates, n.o.s.; Arsenites, n.o.s.; and Arsenic sulphides, n.o.s.	6.1		II	Category A	SG70
1557	ARSENIC COMPOUND, SOLID, N.O.S. inorganic, including: Arsenates, n.o.s.; Arsenites, n.o.s.; and Arsenic sulphides, n.o.s.	6.1		III	Category A	SG70
1558	ARSENIC	6.1		II	Category A	
1559	ARSENIC PENTOXIDE	6.1		II	Category A	
1560	ARSENIC TRICHLORIDE	6.1		I	Category B SW2	
1561	ARSENIC TRIOXIDE	6.1		II	Category A	
1562	ARSENICAL DUST	6.1		II	Category A	
1564	BARIUM COMPOUND, N.O.S.	6.1		II	Category A	
1564	BARIUM COMPOUND, N.O.S.	6.1		III	Category A	
1565	BARIUM CYANIDE	6.1	P	I	Category A SW2	SG35
1566	BERYLLIUM COMPOUND, N.O.S.	6.1		II	Category A	

UN Number	PROPER SHIPPING NAME (Note: When there is more than one packing group or PSN the UN No. has been annotated with a, b, c)	Class or division	Subsidiary risk(s)	Packing Group	Stowage and Handling	Segregation
1566	BERYLLIUM COMPOUND, N.O.S.	6.1		III	Category A	
1567	BERYLLIUM POWDER	6.1	4.1	II	Category A	
1569	BROMOACETONE	6.1	3P	II	Category D SW2	
1570	BRUCINE	6.1		I	Category A	
1571	BARIUM AZIDE, WETTED with not less than 50% water, by mass	4.1	6.1	I	Category D	SG7 SG30
1572	CACODYLIC ACID	6.1		II	Category E	SG35
1573	CALCIUM ARSENATE	6.1	P	II	Category A	
1574	CALCIUM ARSENATE AND CALCIUM ARSENITE MIXTURE, SOLID	6.1	P	II	Category A	
1575	CALCIUM CYANIDE	6.1	P	I	Category A SW2	SG35
1577	CHLORODINITROBENZENES, LIQUID	6.1	P	II	Category A	SG15
1578	CHLORONITROBENZENES, SOLID	6.1		II	Category A	
1579	4-CHLORO-o-TOLUIDINE HYDROCHLORIDE, SOLID	6.1		III	Category A	
1580	CHLOROPICRIN	6.1	P	I	Category D SW2	
1581	CHLOROPICRIN AND METHYL BROMIDE MIXTURE with more than 2% chloropicrin	2.3			Category D SW1 SW2	
1582	CHLOROPICRIN AND METHYL CHLORIDE MIXTURE	2.3			Category D SW1 SW2	
1583	CHLOROPICRIN MIXTURE, N.O.S.	6.1		I	Category C SW2	
1583	CHLOROPICRIN MIXTURE, N.O.S.	6.1		II	Category C SW2	
1583	CHLOROPICRIN MIXTURE, N.O.S.	6.1		III	Category C SW2	
1585	COPPER ACETOARSENITE	6.1	P	II	Category A	
1586	COPPER ARSENITE	6.1	P	II	Category A	
1587	COPPER CYANIDE	6.1	P	II	Category A	SG35
1588	CYANIDES, INORGANIC, SOLID, N.O.S.	6.1	P	I	Category A	SG35
1588	CYANIDES, INORGANIC, SOLID, N.O.S.	6.1	P	II	Category A	SG35
1588	CYANIDES, INORGANIC, SOLID, N.O.S.	6.1	P	III	Category A	SG35
1589	CYANOGEN CHLORIDE, STABILIZED	2.3	8P		Category D SW2	
1590	DICHLOROANILINES, LIQUID	6.1	P	II	Category A SW2	
1591	o-DICHLOROBENZENE	6.1		III	Category A	
1593	DICHLOROMETHANE	6.1		III	Category A	
1594	DIETHYL SULPHATE	6.1		II	Category C	
1595	DIMETHYL SULPHATE	6.1	8	I	Category D SW2	
1596	DINITROANILINES	6.1		II	Category A	SG15
1597	DINITROBENZENES, LIQUID	6.1		II	Category A	SG15
1597	DINITROBENZENES, LIQUID	6.1		III	Category A	SG15
1598	DINITRO-o-CRESOL	6.1	P	II	Category A	
1599	DINITROPHENOL SOLUTION	6.1	P	II	Category A	SG30

UN Number	PROPER SHIPPING NAME (Note: When there is more than one packing group or PSN the UN No. has been annotated with a, b, c)	Class or division	Subsidiary risk(s)	Packing Group	Stowage and Handling	Segregation
1599	DINITROPHENOL SOLUTION	6.1	P	III	Category A	SG30
1600	DINITROTOLUENES, MOLTEN	6.1		II	Category C	
1601	DISINFECTANT, SOLID, TOXIC, N.O.S.	6.1		I	Category A SW2	
1601	DISINFECTANT, SOLID, TOXIC, N.O.S.	6.1		II	Category A SW2	
1601	DISINFECTANT, SOLID, TOXIC, N.O.S.	6.1		III	Category A SW2	
1602	DYE, LIQUID, TOXIC, N.O.S. or DYE INTERMEDIATE, LIQUID, TOXIC, N.O.S.	6.1		I	Category A	
1602	DYE, LIQUID, TOXIC, N.O.S. or DYE INTERMEDIATE, LIQUID, TOXIC, N.O.S.	6.1		II	Category A	
1602	DYE, LIQUID, TOXIC, N.O.S. or DYE INTERMEDIATE, LIQUID, TOXIC, N.O.S.	6.1		III	Category A	
1603	ETHYL BROMOACETATE	6.1	3	II	Category D SW2	
1604	ETHYLENEDIAMINE	8	3	II	Category A SW2	SG35
1605	ETHYLENE DIBROMIDE	6.1		I	Category D SW2	
1606	FERRIC ARSENATE	6.1	P	II	Category A	
1607	FERRIC ARSENITE	6.1	P	II	Category A	
1608	FEROUS ARSENATE	6.1	P	II	Category A	
1611	HEXAETHYL TETRAPHOSPHATE	6.1	P	II	Category E SW2	
1612	HEXAETHYL TETRAPHOSPHATE AND COMPRESSED GAS MIXTURE	2.3			Category D SW2	
1613	HYDROCYANIC ACID, AQUEOUS SOLUTION (HYDROGEN CYANIDE, AQUEOUS SOLUTION) with not more th	6.1	P	I	Category D SW2	
1614	HYDROGEN CYANIDE, STABILIZED containing less than 3% water and absorbed in a porous iner	6.1	P	I	Category D SW1 SW2	
1616	LEAD ACETATE	6.1	P	III	Category A	
1617	LEAD ARSENATES	6.1	P	II	Category A	
1618	LEAD ARSENITES	6.1	P	II	Category A	
1620	LEAD CYANIDE	6.1	P	II	Category A	SG35
1621	LONDON PURPLE	6.1	P	II	Category A	
1622	MAGNESIUM ARSENATE	6.1	P	II	Category A	
1623	MERCURIC ARSENATE	6.1	P	II	Category A	
1624	MERCURIC CHLORIDE	6.1	P	II	Category A	
1625	MERCURIC NITRATE	6.1	P	II	Category A	
1626	MERCURIC POTASSIUM CYANIDE	6.1	P	I	Category A	SG35
1627	MERCUROUS NITRATE	6.1	P	II	Category A	
1629	MERCURY ACETATE	6.1	P	II	Category A	
1630	MERCURY AMMONIUM CHLORIDE	6.1	P	II	Category A	
1631	MERCURY BENZOATE	6.1	P	II	Category A	
1634	MERCURY BROMIDES	6.1	P	II	Category A	
1636	MERCURY CYANIDE	6.1	P	II	Category A	SG35

UN Number	PROPER SHIPPING NAME (Note: When there is more than one packing group or PSN the UN No. has been annotated with a, b, c)	Class or division	Subsidiary risk(s)	Packing Group	Stowage and Handling	Segregation
1637	MERCURY GLUCONATE	6.1	P	II	Category A	
1638	MERCURY IODIDE	6.1	P	II	Category A	
1639	MERCURY NUCLEATE	6.1	P	II	Category A	
1640	MERCURY OLEATE	6.1	P	II	Category A	
1641	MERCURY OXIDE	6.1	P	II	Category A	
1642	MERCURY OXYCYANIDE, DESENSITIZED	6.1	P	II	Category A	SG15 SG35
1643	MERCURY POTASSIUM IODIDE	6.1	P	II	Category A	
1644	MERCURY SALICYLATE	6.1	P	II	Category A	
1645	MERCURY SULPHATE	6.1	P	II	Category A	
1646	MERCURY THIOCYANATE	6.1	P	II	Category A	
1647	METHYL BROMIDE AND ETHYLENE DIBROMIDE MIXTURE, LIQUID	6.1	P	I	Category D SW2	
1648	ACETONITRILE	3		II	Category B SW2	
1649	MOTOR FUEL ANTI-KNOCK MIXTURE	6.1	P	I	Category D SW1 SW2	
1650	beta-NAPHTHYLAMINE, SOLID	6.1		II	Category A	
1651	NAPHTHYLTHIOUREA	6.1		II	Category A	
1652	NAPHTHYLUREA	6.1		II	Category A	
1653	NICKEL CYANIDE	6.1	P	II	Category A	SG35
1654	NICOTINE	6.1		II	Category A	
1655	NICOTINE COMPOUND, SOLID, N.O.S. or NICOTINE PREPARATION, SOLID, N.O.S.	6.1		I	Category B	
1655	NICOTINE COMPOUND, SOLID, N.O.S. or NICOTINE PREPARATION, SOLID, N.O.S.	6.1		II	Category A	
1655	NICOTINE COMPOUND, SOLID, N.O.S. or NICOTINE PREPARATION, SOLID, N.O.S.	6.1		III	Category A	
1656	NICOTINE HYDROCHLORIDE, LIQUID or SOLUTION	6.1		II	Category A	
1656	NICOTINE HYDROCHLORIDE, LIQUID or SOLUTION	6.1		III	Category A	
1657	NICOTINE SALICYLATE	6.1		II	Category A	
1658	NICOTINE SULPHATE SOLUTION	6.1		II	Category A	
1658	NICOTINE SULPHATE SOLUTION	6.1		III	Category A	
1659	NICOTINE TARTRATE	6.1		II	Category A	
1660	NITRIC OXIDE, COMPRESSED	2.3	5.1/8		Category D SW2	SG6 SG19
1661	NITROANILINES (o-, m-, p-)	6.1		II	Category A	
1662	NITROBENZENE	6.1		II	Category A SW2	
1663	NITROPHENOLS (o-, m-, p-)	6.1		III	Category A	
1664	NITROTOLUENES, LIQUID	6.1		II	Category A	
1665	NITROXYLENES, LIQUID	6.1		II	Category A	
1669	PENTACHLOROETHANE	6.1	P	II	Category A SW2	
1670	PERCHLOROMETHYL MERCAPTAN	6.1	P	I	Category D SW2	
1671	PHENOL, SOLID	6.1		II	Category A	

UN Number	PROPER SHIPPING NAME (Note: When there is more than one packing group or PSN the UN No. has been annotated with a, b, c)	Class or division	Subsidiary risk(s)	Packing Group	Stowage and Handling	Segregation
1672	PHENYL CARBYLAMINE CHLORIDE	6.1		I	Category D SW2	
1673	PHENYLENEDIAMINES (o-, m-, p-)	6.1		III	Category A	
1674	PHENYL MERCURIC ACETATE	6.1	P	II	Category A	
1677	POTASSIUM ARSENATE	6.1		II	Category A	
1678	POTASSIUM ARSENITE	6.1		II	Category A	
1679	POTASSIUM CUPROCYANIDE	6.1	P	II	Category A	SG35
1680	POTASSIUM CYANIDE, SOLID	6.1	P	I	Category B	SG35
1683	SILVER ARSENITE	6.1	P	II	Category A	
1684	SILVER CYANIDE	6.1	P	II	Category A SW2	SG35
1685	SODIUM ARSENATE	6.1		II	Category A	
1686	SODIUM ARSENITE, AQUEOUS SOLUTION	6.1		II	Category A	
1686	SODIUM ARSENITE, AQUEOUS SOLUTION	6.1		III	Category A	
1687	SODIUM AZIDE	6.1		II	Category A	SG15 SG30 SG35
1688	SODIUM CACODYLATE	6.1		II	Category A	SG35
1689	SODIUM CYANIDE, SOLID	6.1	P	I	Category B	SG35
1690	SODIUM FLUORIDE, SOLID	6.1		III	Category A	SG35
1691	STRONTIUM ARSENITE	6.1		II	Category A	
1692	STRYCHNINE or STRYCHNINE SALTS	6.1	P	I	Category A	
1693	TEAR GAS SUBSTANCE, LIQUID, N.O.S.	6.1		I	Category D SW2	
1693	TEAR GAS SUBSTANCE, LIQUID, N.O.S.	6.1		II	Category D SW2	
1694	BROMOBENZYL CYANIDES, LIQUID	6.1		I	Category D SW1 SW2 H2	SG35
1695	CHLOROACETONE, STABILIZED	6.1	3/8P	I	Category D SW2	SG5 SG8
1697	CHLOROACETOPHENONE, SOLID	6.1		II	Category D SW1 SW2 H2	
1698	DIPHENYLAMINE CHLOROARSINE	6.1	P	I	Category D SW2	
1699	DIPHENYLCHLOROARSINE, LIQUID	6.1	P	I	Category D SW2	
1700	TEAR GAS CANDLES	6.1	4.1	II	Category D SW2	
1701	XYLYL BROMIDE, LIQUID	6.1		II	Category D SW2	
1702	1,1,2,2-TETRACHLOROETHANE	6.1	P	II	Category A SW2	
1704	TETRAETHYL DITHIOPYROPHOSPHATE	6.1	P	II	Category D SW2	
1707	THALLIUM COMPOUND, N.O.S.	6.1	P	II	Category A	
1708	TOLUIDINES, LIQUID	6.1		II	Category A	
1709	2,4-TOLUYLENEDIAMINE, SOLID	6.1		III	Category A	
1710	TRICHLOROETHYLENE	6.1		III	Category A SW2	



UN Number	PROPER SHIPPING NAME (Note: When there is more than one packing group or PSN the UN No. has been annotated with a, b, c)	Class or division	Subsidiary risk(s)	Packing Group	Stowage and Handling	Segregation
1711	XYLIDINES, LIQUID	6.1		II	Category A	
1712	ZINC ARSENATE or ZINC ARSENITE or ZINC ARSENATE, ZINC ARSENITE MIXTURE	6.1		II	Category A	
1713	ZINC CYANIDE	6.1	P	I	Category A	SG35
1714	ZINC PHOSPHIDE	4.3	6.1	I	Category E SW2 SW5	SG35
1715	ACETIC ANHYDRIDE	8	3	II	Category A SW2	
1716	ACETYL BROMIDE	8		II	Category C SW2	
1717	ACETYL CHLORIDE	3	8	II	Category B SW2	
1718	BUTYL ACID PHOSPHATE	8		III	Category A	
1719	CAUSTIC ALKALI LIQUID, N.O.S.	8		II	Category A	SG22 SG35
1719	CAUSTIC ALKALI LIQUID, N.O.S.	8		III	Category A	SG22 SG35
1722	ALLYL CHLOROFORMATE	6.1	*3/8	I	Category D SW2	SG5 SG8
1723	ALLYL IODIDE	3	8	II	Category B SW2	
1724	ALLYLTRICHLOROSILANE, STABILIZED	8	3	II	Category C SW2	
1725	ALUMINIUM BROMIDE, ANHYDROUS	8		II	Category A SW2	
1726	ALUMINIUM CHLORIDE, ANHYDROUS	8		II	Category A SW2	
1727	AMMONIUM HYDROGENDIFLUORIDE, SOLID	8		II	Category A SW1 SW2	SG35
1728	AMYLTRICHLOROSILANE	8		II	Category C SW2	
1729	ANISOYL CHLORIDE	8		II	Category C SW2	
1730	ANTIMONY PENTACHLORIDE, LIQUID	8		II	Category C SW2	
1731	ANTIMONY PENTACHLORIDE SOLUTION	8		II	Category C SW2	
1731	ANTIMONY PENTACHLORIDE SOLUTION	8		III	Category C SW2	
1732	ANTIMONY PENTAFLUORIDE	8	6.1	II	Category D SW2	SG6 SG8 SG10 SG12
1733	ANTIMONY TRICHLORIDE	8		II	Category C SW2	
1736	BENZOYL CHLORIDE	8		II	Category C SW2	
1737	BENZYL BROMIDE	6.1		II	Category D SW2 H1	
1738	BENZYL CHLORIDE	6.1	8	II	Category D SW2 H1	
1739	BENZYL CHLOROFORMATE	8	P	I	Category D SW2	

UN Number	PROPER SHIPPING NAME (Note: When there is more than one packing group or PSN the UN No. has been annotated with a, b, c)	Class or division	Subsidiary risk(s)	Packing Group	Stowage and Handling	Segregation
1740	HYDROGEN DIFLUORIDES, SOLID, N.O.S.	8		II	Category A SW1 SW2	SG35
1740	HYDROGEN DIFLUORIDES, SOLID, N.O.S.	8		III	Category A SW1 SW2	SG35
1741	BORON TRICHLORIDE	2.3	8		Category D SW1 SW2	
1742	BORON TRIFLUORIDE ACETIC ACID COMPLEX, LIQUID	8		II	Category A	
1743	BORON TRIFLUORIDE PROPIONIC ACID COMPLEX, LIQUID	8		II	Category A	
1744	BROMINE or BROMINE SOLUTION	8	6.1	I	Category D SW1 SW2 H2	SG6 SG16 SG17 SG19
1745	BROMINE PENTAFLUORIDE	5.1	6.1/8	I	Category D SW1 SW2	SG6 SG16 SG19
1746	BROMINE TRIFLUORIDE	5.1	6.1/8	I	Category D SW1 SW2	SG6 SG16 SG19
1747	BUTYLTRICHLOROSILANE	8	3	II	Category C SW2	
1748	CALCIUM HYPOCHLORITE, DRY or CALCIUM HYPOCHLORITE MIXTURE, DRY with more than 39% available chlorine (8.8% available oxygen)	5.1		II	Category D SW1 SW11	SG35 SG38 SG49 SG53 SG60
1748	CALCIUM HYPOCHLORITE, DRY or CALCIUM HYPOCHLORITE MIXTURE, DRY with more than 39% available chlorine (8.8% available oxygen)	5.1		III	Category D SW1 SW11	SG35 SG38 SG49 SG53 SG60
1749	CHLORINE TRIFLUORIDE	2.3	5.1/8		Category D SW2	SG6 SG19
1750	CHLOROACETIC ACID SOLUTION	6.1	8	II	Category C SW2	
1751	CHLOROACETIC ACID, SOLID	6.1	8	II	Category C SW2	
1752	CHLOROACETYL CHLORIDE	6.1	8	I	Category D SW2	
1753	CHLOROPHENYLTRICHLOROSILANE	8	P	II	Category C SW2	
1754	CHLOROSULPHONIC ACID (with or without sulphur trioxide)	8		I	Category C SW2	
1755	CHROMIC ACID SOLUTION	8		II	Category C SW2	SG6 SG8 SG10 SG12
1755	CHROMIC ACID SOLUTION	8		III	Category C SW2	SG6 SG8 SG10 SG12
1756	CHROMIC FLUORIDE, SOLID	8		II	Category A	SG35
1757	CHROMIC FLUORIDE SOLUTION	8		II	Category A	
1757	CHROMIC FLUORIDE SOLUTION	8		III	Category A	
1758	CHROMIUM OXYCHLORIDE	8		I	Category C SW2	SG6 SG16 SG17 SG19

UN Number	PROPER SHIPPING NAME (Note: When there is more than one packing group or PSN the UN No. has been annotated with a, b, c)	Class or division	Subsidiary risk(s)	Packing Group	Stowage and Handling	Segregation
1759	CORROSIVE SOLID, N.O.S.	8		I	Category B	
1759	CORROSIVE SOLID, N.O.S.	8		II	Category A	
1759	CORROSIVE SOLID, N.O.S.	8		III	Category A	
1760	CORROSIVE LIQUID, N.O.S.	8		I	Category B SW2	
1760	CORROSIVE LIQUID, N.O.S.	8		II	Category B SW2	
1760	CORROSIVE LIQUID, N.O.S.	8		III	Category A SW2	
1761	CUPRIETHYLENEDIAMINE SOLUTION	8	6.1 P	II	Category A	
1761	CUPRIETHYLENEDIAMINE SOLUTION	8	6.1 P	III	Category A	
1762	CYCLOHEXYLTRICHLOROSILANE	8		II	Category C SW2	
1763	CYCLOHEXYLTRICHLOROSILANE	8		II	Category C SW2	
1764	DICHLOROACETIC ACID	8		II	Category A	
1765	DICHLOROACETYL CHLORIDE	8		II	Category D SW2	
1766	DICHLOROPHENYLTRICHLOROSILANE	8	P	II	Category C SW2	
1767	DIETHYLDICHLOROSILANE	8	3	II	Category C SW2	
1768	DIFLUOROPHOSPHORIC ACID, ANHYDROUS	8		II	Category A SW2	
1769	DIPHENYLDICHLOROSILANE	8		II	Category C SW2	
1770	DIPHENYLMETHYL BROMIDE	8		II	Category D SW2	
1771	DODECYLTRICHLOROSILANE	8		II	Category C SW2	
1773	FERRIC CHLORIDE, ANHYDROUS	8		III	Category A	
1774	FIRE EXTINGUISHER CHARGES corrosive liquid	8		II	Category A	
1775	FLUOROBORIC ACID	8		II	Category A	
1776	FLUOROPHOSPHORIC ACID, ANHYDROUS	8		II	Category A	
1777	FLUOROSULPHONIC ACID	8		I	Category D SW2	
1778	FLUROSILICIC ACID	8		II	Category A	
1779	FORMIC ACID with more than 85% acid, by mass	8	3	II	Category A SW2	
1780	FUMARYL CHLORIDE	8		II	Category C SW2	
1781	HEXADECYLTRICHLOROSILANE	8		II	Category C SW2	
1782	HEXAFLUOROPHOSPHORIC ACID	8		II	Category A	
1783	HEXAMETHYLENEDIAMINE SOLUTION	8		II	Category A	
1783	HEXAMETHYLENEDIAMINE SOLUTION	8		III	Category A	
1784	HEXYLTRICHLOROSILANE	8		II	Category C SW2	
1786	HYDROFLUORIC ACID AND SULPHURIC ACID MIXTURE	8	6.1	I	Category D SW2	
1787	HYDRIODIC ACID	8		II	Category C	

UN Number	PROPER SHIPPING NAME (Note: When there is more than one packing group or PSN the UN No. has been annotated with a, b, c)	Class or division	Subsidiary risk(s)	Packing Group	Stowage and Handling	Segregation
1787	HYDRIODIC ACID	8		III	Category C	
1788	HYDROBROMIC ACID	8		II	Category C	
1788	HYDROBROMIC ACID	8		III	Category C	
1789	HYDROCHLORIC ACID	8		II	Category C	
1789	HYDROCHLORIC ACID	8		III	Category C	
1790	HYDROFLUORIC ACID solution, with more than 60% hydrogen fluoride	8	6.1	I	Category D SW1 SW2 H2	
1790	HYDROFLUORIC ACID solution, with not more than 60% hydrogen fluoride	8	6.1	II	Category D SW1 SW2 H2	
1791	HYPOCHLORITE SOLUTION	8		II	Category B	SG20
1791	HYPOCHLORITE SOLUTION	8		III	Category B	SG20
1792	IODINE MONOCHLORIDE	8		II	Category D SW2	SG6 SG16 SG17 SG19
1793	ISOPROPYL ACID PHOSPHATE	8		III	Category A	
1794	LEAD SULPHATE with more than 3% free acid	8		II	Category A	
1796	NITRATING ACID MIXTURE with more than 50% nitric acid	8	5.1	I	Category D SW2	SG16
1796	NITRATING ACID MIXTURE with not more than 50% nitric acid	8		II	Category D SW2	
1798	NITROHYDROCHLORIC ACID	8		I	Category D SW2	SG6 SG16 SG17 SG19
1799	NONYLTRICHLOROSILANE	8		II	Category C SW2	
1800	OCTADECYLTRICHLOROSILANE	8		II	Category C SW2	
1801	OCTYLTRICHLOROSILANE	8		II	Category C SW2	
1802	PERCHLORIC ACID with not more than 50% acid, by mass	8	5.1	II	Category C	SG16
1803	PHENOLSULPHONIC ACID, LIQUID	8		II	Category C SW15	
1804	PHENYLTRICHLOROSILANE	8		II	Category C SW2	
1805	PHOSPHORIC ACID SOLUTION	8		III	Category A	
1806	PHOSPHORUS PENTACHLORIDE	8		II	Category C SW2	SG6 SG8 SG10 SG12
1807	PHOSPHORUS PENTOXIDE	8		II	Category A	
1808	PHOSPHORUS TRIBROMIDE	8		II	Category C SW2	
1809	PHOSPHORUS TRICHLORIDE	6.1	8	I	Category D SW2	
1810	PHOSPHORUS OXYCHLORIDE	6.1	8	I	Category D SW2	
1811	POTASSIUM HYDROGEN DIFLUORIDE, SOLID	8	6.1	II	Category A SW1 SW2	SG35
1812	POTASSIUM FLUORIDE, SOLID	6.1		III	Category A	SG35
1813	POTASSIUM HYDROXIDE, SOLID	8		II	Category A	SG35

UN Number	PROPER SHIPPING NAME (Note: When there is more than one packing group or PSN the UN No. has been annotated with a, b, c.)	Class or division	Subsidiary risk(s)	Packing Group	Stowage and Handling	Segregation
1814	POTASSIUM HYDROXIDE SOLUTION	8		II	Category A	SG35
1814	POTASSIUM HYDROXIDE SOLUTION	8		III	Category A	SG35
1815	PROPIONYL CHLORIDE	3	8	II	Category B SW2	
1816	PROPYLTRICHLOROSILANE	8	3	II	Category C SW2	
1817	PYROSULPHURYL CHLORIDE	8		II	Category C SW2	
1818	SILICON TETRACHLORIDE	8		II	Category C SW2	SG72
1819	SODIUM ALUMINATE SOLUTION	8		II	Category A	SG35
1819	SODIUM ALUMINATE SOLUTION	8		III	Category A	SG35
1823	SODIUM HYDROXIDE, SOLID	8		II	Category A	SG35
1824	SODIUM HYDROXIDE SOLUTION	8		II	Category A	SG35
1824	SODIUM HYDROXIDE SOLUTION	8		III	Category A	SG35
1825	SODIUM MONOXIDE	8		II	Category A	SG35
1826	NITRATING ACID MIXTURE, SPENT with more than 50% nitric acid	8	5.1	I	Category D SW2	SG16
1826	NITRATING ACID MIXTURE, SPENT with not more than 50% nitric acid	8		II	Category D SW2	
1827	STANNIC CHLORIDE, ANHYDROUS	8		II	Category C	
1828	SULPHUR CHLORIDES	8		I	Category C SW2	
1829	SULPHUR TRIOXIDE, STABILIZED	8		I	Category C SW2	
1830	SULPHURIC ACID with more than 51% acid	8		II	Category C SW15	
1831	SULPHURIC ACID, FUMING	8	6.1	I	Category C SW2 SW15	
1832	SULPHURIC ACID, SPENT	8		II	Category C SW15	
1833	SULPHUROUS ACID	8		II	Category B SW2	
1834	SULPHURYL CHLORIDE	6.1	8	I	Category D SW2	
1835	TETRAMETHYLAMMONIUM HYDROXIDE SOLUTION	8		II	Category A	SG35
1835	TETRAMETHYLAMMONIUM HYDROXIDE SOLUTION	8		III	Category A	SG35
1836	THIONYL CHLORIDE	8		I	Category C SW2	
1837	THIOPHOSPHORYL CHLORIDE	8		II	Category C SW2	
1838	TITANIUM TETRACHLORIDE	6.1	8	I	Category D SW2	
1839	TRICHLOROACETIC ACID, SOLID	8		II	Category A	
1840	ZINC CHLORIDE SOLUTION	8		III	Category A	
1841	ACETALDEHYDE AMMONIA	9		III	Category A	SG29
1843	AMMONIUM DINITRO-o-CRESOLATE, SOLID	6.1	P	II	Category B	SG15 SG16 SG30 SG63
1845	CARBON DIOXIDE, SOLID (DRY ICE)	9			Category C SW2	

UN Number	PROPER SHIPPING NAME (Note: When there is more than one packing group or PSN the UN No. has been annotated with a, b, c)	Class or division	Subsidiary risk(s)	Packing Group	Stowage and Handling	Segregation
1846	CARBON TETRACHLORIDE	6.1	P	II	Category A SW2	
1847	POTASSIUM SULPHIDE, HYDRATED with not less than 30% water of crystallization	8		II	Category A	SG35
1848	PROPIONIC ACID with not less than 10% and less than 90% acid, by mass	8		III	Category A	
1849	SODIUM SULPHIDE, HYDRATED with not less than 30% water	8		II	Category A	SG35
1851	MEDICINE, LIQUID, TOXIC, N.O.S.	6.1		II	Category C SW2	
1851	MEDICINE, LIQUID, TOXIC, N.O.S.	6.1		III	Category C SW2	
1854	BARIUM ALLOYS, PYROPHORIC	4.2		I	Category D	
1855	CALCIUM, PYROPHORIC or CALCIUM ALLOYS, PYROPHORIC	4.2		I	Category D	
1856	RAGS, OILY	4.2			Category A	
1857	TEXTILE WASTE, WET	4.2		III	Category A	
1858	HEXAFLUOROPROPYLENE (REFRIGERANT GAS R 1216)	2.2			Category A	
1859	SILICON TETRAFLUORIDE	2.3	8		Category D SW2	
1860	VINYL FLUORIDE, STABILIZED	2.1			Category E SW2	
1862	ETHYL CROTONATE	3		II	Category B	
1863	FUEL, AVIATION, TURBINE ENGINE	3		I	Category E	
1863	FUEL, AVIATION, TURBINE ENGINE	3		II	Category B	
1863	FUEL, AVIATION, TURBINE ENGINE	3		III	Category A	
1865	n-PROPYL NITRATE	3		II	Category D	SG6 SG8 SG10 SG12
1866	RESIN SOLUTION flammable	3		I	Category E	
1866	RESIN SOLUTION flammable	3		II	Category B	
1866	RESIN SOLUTION flammable	3		III	Category A	
1868	DECABORANE	4.1	6.1	II	Category A	SG17
1869	MAGNESIUM or MAGNESIUM ALLOYS with more than 50% magnesium in pellets, turnings or ribbons	4.1		III	Category A	SG17 SG32 SG35 SG36 SG52
1870	POTASSIUM BOROHYDRIDE	4.3		I	Category E	SG35
1871	TITANIUM HYDRIDE	4.1		II	Category E	
1872	LEAD DIOXIDE	5.1		III	Category A	
1873	PERCHLORIC ACID with more than 50% but not more than 72% acid, by mass	5.1	8	I	Category D	SG16
1884	BARIUM OXIDE	6.1		III	Category A	
1885	BENZIDINE	6.1		II	Category A	
1886	BENZYLIDENE CHLORIDE	6.1		II	Category D SW2	
1887	BROMOCHLOROMETHANE	6.1		III	Category A	
1888	CHLOROFORM	6.1		III	Category A SW2	

UN Number	PROPER SHIPPING NAME (Note: When there is more than one packing group or PSN the UN No. has been annotated with a, b, c.)	Class or division	Subsidiary risk(s)	Packing Group	Stowage and Handling	Segregation
1889	CYANOGEN BROMIDE	6.1	8P	I	Category D SW2	SG35
1891	ETHYL BROMIDE	6.1		II	Category B SW2 SW5	
1892	ETHYLDICHLOROARSINE	6.1	P	I	Category D SW2	
1894	PHENYLMERCURIC HYDROXIDE	6.1	P	II	Category A	
1895	PHENYLMERCURIC NITRATE	6.1	P	II	Category A	
1897	TETRACHLOROETHYLENE	6.1	P	III	Category A SW2	
1898	ACETYL IODIDE	8		II	Category C SW2	
1902	DIISOCTYL ACID PHOSPHATE	8		III	Category A	
1903	DISINFECTANT, LIQUID, CORROSIVE, N.O.S.	8		I	Category B	
1903	DISINFECTANT, LIQUID, CORROSIVE, N.O.S.	8		II	Category B	
1903	DISINFECTANT, LIQUID, CORROSIVE, N.O.S.	8		III	Category A	
1905	SELENIC ACID	8		I	Category A	
1906	SLUDGE ACID	8		II	Category C SW15	
1907	SODA LIME with more than 4% sodium hydroxide	8		III	Category A	SG35
1908	CHLORITE SOLUTION	8		II	Category B	SG6 SG8 SG10 SG12 SG20
1908	CHLORITE SOLUTION	8		III	Category B	SG6 SG8 SG10 SG12 SG20
1910	CALCIUM OXIDE	8		-	-	
1911	DIBORANE	2.3	2.1		Category D SW2	SG46
1912	METHYL CHLORIDE AND METHYLENE CHLORIDE MIXTURE	2.1			Category D SW2	
1913	NEON, REFRIGERATED LIQUID	2.2			Category D	
1914	BUTYL PROPIONATES	3		III	Category A	
1915	CYCLOHEXANONE	3		III	Category A	
1916	2,2-DICHLORODIETHYL ETHER	6.1	3	II	Category A	
1917	ETHYL ACRYLATE, STABILIZED	3		II	Category B SW2	
1918	ISOPROPYLBENZENE	3		III	Category A	
1919	METHYL ACRYLATE, STABILIZED	3		II	Category B	
1920	NONANES	3		III	Category A	
1921	PROPYLENEIMINE, STABILIZED	3	6.1	I	Category B SW2	
1922	PYRROLIDINE	3	8	II	Category B SW2	SG35
1923	CALCIUM DITHIONITE (CALCIUM HYDROSULPHITE)	4.2		II	Category E H1	
1928	METHYLMAGNESIUM BROMIDE IN ETHYL ETHER	4.3	3	I	Category D	
1929	POTASSIUM DITHIONITE (POTASSIUM HYDROSULPHITE)	4.2		II	Category E H1	

UN Number	PROPER SHIPPING NAME (Note: When there is more than one packing group or PSN the UN No. has been annotated with a, b, c)	Class or division	Subsidiary risk(s)	Packing Group	Stowage and Handling	Segregation
1931	ZINC DITHIONITE (ZINC HYDROSULPHITE)	9		III	Category A H1	SG11 SG20
1932	ZIRCONIUM, SCRAP	4.2		III	Category D	
1935	CYANIDE SOLUTION, N.O.S.	6.1	P	I	Category B SW2	SG35
1935	CYANIDE SOLUTION, N.O.S.	6.1	P	II	Category A SW2	SG35
1935	CYANIDE SOLUTION, N.O.S.	6.1	P	III	Category A SW2	SG35
1938	BROMOACETIC ACID SOLUTION	8		II	Category A SW2	
1938	BROMOACETIC ACID SOLUTION	8		III	Category A SW2	
1939	PHOSPHORUS OXYBROMIDE, SOLID	8		II	Category C SW1 SW2 H2	
1940	THIOGLYCOLIC ACID	8		II	Category A	
1941	DIBROMODIFLUOROMETHANE	9		III	Category A SW1	
1942	AMMONIUM NITRATE with not more than 0.2% total combustible material, including any organ	5.1		III	Category C SW1 SW14 SW23	SG16 SG42 SG45 SG47 SG48 SG51 SG56 SG58 SG59 SG61
1944	MATCHES, SAFETY (book, card or strike on box)	4.1		III	Category A	
1945	MATCHES, WAX 'VESTA'	4.1		III	Category B	
1950	AEROSOLS	2	SP63		- SW1 SW22	SG69
1951	ARGON, REFRIGERATED LIQUID	2.2			Category D	
1952	ETHYLENE OXIDE AND CARBON DIOXIDE MIXTURE with not more than 9% ethylene oxide	2.2			Category A	
1953	COMPRESSED GAS, TOXIC, FLAMMABLE, N.O.S.	2.3	2.1		Category D SW2	
1954	COMPRESSED GAS, FLAMMABLE, N.O.S.	2.1			Category D SW2	
1955	COMPRESSED GAS, TOXIC, N.O.S.	2.3			Category D SW2	
1956	COMPRESSED GAS, N.O.S.	2.2			Category A	
1957	DEUTERIUM, COMPRESSED	2.1			Category E SW2	
1958	1,2-DICHLORO-1,1,2,2-TETRAFLUOROETHANE (REFRIGERANT GAS R 114)	2.2			Category A	
1959	1,1-DIFLUOROETHYLENE (REFRIGERANT GAS R 1132a)	2.1			Category E SW2	
1961	ETHANE, REFRIGERATED LIQUID	2.1			Category D SW2	
1962	ETHYLENE	2.1			Category E SW2	
1963	HELIUM, REFRIGERATED LIQUID	2.2			Category D	



UN Number	PROPER SHIPPING NAME (Note: When there is more than one packing group or PSN the UN No. has been annotated with a, b, c)	Class or division	Subsidiary risk(s)	Packing Group	Stowage and Handling	Segregation
1964	HYDROCARBON GAS MIXTURE, COMPRESSED, N.O.S.	2.1			Category E SW2	
1965	HYDROCARBON GAS MIXTURE, LIQUEFIED, N.O.S.	2.1			Category E SW2	
1966	HYDROGEN, REFRIGERATED LIQUID	2.1			Category D SW2	SG46
1967	INSECTICIDE GAS, TOXIC, N.O.S.	2.3			Category D SW2	
1968	INSECTICIDE GAS, N.O.S.	2.2			Category A	
1969	ISOBUTANE	2.1			Category E SW2	
1970	KRYPTON, REFRIGERATED LIQUID	2.2			Category D	
1971	METHANE, COMPRESSED or NATURAL GAS, COMPRESSED with high methane content	2.1			Category E SW2	
1972	METHANE, REFRIGERATED LIQUID or NATURAL GAS, REFRIGERATED LIQUID with high methane conte	2.1			Category D SW2	
1973	CHLORODIFLUOROMETHANE AND CHLOROPENTAFLUROETHANE MIXTURE with a fixed boiling point, with approximately 49% chlorodifluoromethane (REFRIGERANT GAS R 502)	2.2			Category A	
1974	CHLORODIFLUOROBROMOMET HANE (REFRIGERANT GAS R 12B1)	2.2			Category A	
1975	NITRIC OXIDE AND DINITROGEN TETROXIDE MIXTURE (NITRIC OXIDE AND NITROGEN DIOXIDE MIXTURE	2.3			Category D SW2	SG6 SG19
1976	OCTAFLUOROCYCLOBUTANE (REFRIGERANT GAS RC 318)	2.2			Category A	
1977	NITROGEN, REFRIGERATED LIQUID	2.2			Category D	
1978	PROPANE	2.1			Category E SW2	
1982	TETRAFLUOROMETHANE (REFRIGERANT GAS R 14)	2.2			Category A	
1983	1-CHLORO-2,2,2-TRIFLUOROETHANE (REFRIGERANT GAS R 133a)	2.2			Category A	
1984	TRIFLUOROMETHANE (REFRIGERANT GAS R 23)	2.2			Category A	
1986	ALCOHOLS, FLAMMABLE, TOXIC, N.O.S.	3	6.1	I	Category E SW2	
1986	ALCOHOLS, FLAMMABLE, TOXIC, N.O.S.	3	6.1	II	Category B SW2	
1986	ALCOHOLS, FLAMMABLE, TOXIC, N.O.S.	3	6.1	III	Category A	
1987	ALCOHOLS, N.O.S.	3		II	Category B	
1987	ALCOHOLS, N.O.S.	3		III	Category A	
1988	ALDEHYDES, FLAMMABLE, TOXIC, N.O.S.	3	6.1	I	Category E SW2	
1988	ALDEHYDES, FLAMMABLE, TOXIC, N.O.S.	3	6.1	II	Category B SW2	
1988	ALDEHYDES, FLAMMABLE, TOXIC, N.O.S.	3	6.1	III	Category A	
1989	ALDEHYDES, N.O.S.	3		I	Category E	
1989	ALDEHYDES, N.O.S.	3		II	Category B	
1989	ALDEHYDES, N.O.S.	3		III	Category A	
1990	BENZALDEHYDE	9		III	Category A	

UN Number	PROPER SHIPPING NAME (Note: When there is more than one packing group or PSN the UN No. has been annotated with a, b, c)	Class or division	Subsidiary risk(s)	Packing Group	Stowage and Handling	Segregation
1991	CHLOROPRENE, STABILIZED	3	6.1	I	Category D SW2	
1992	FLAMMABLE LIQUID, TOXIC, N.O.S.	3	6.1	I	Category E SW2	
1992	FLAMMABLE LIQUID, TOXIC, N.O.S.	3	6.1	II	Category B SW2	
1992	FLAMMABLE LIQUID, TOXIC, N.O.S.	3	6.1	III	Category A	
1993	FLAMMABLE LIQUID, N.O.S.	3		I	Category E	
1993	FLAMMABLE LIQUID, N.O.S.	3		II	Category B	
1993	FLAMMABLE LIQUID, N.O.S.	3		III	Category A	
1994	IRON PENTACARBONYL	6.1	3	I	Category D SW2	
1999	TARS, LIQUID, including road oils and cutback bitumens	3		II	Category B	
1999	TARS, LIQUID, including road oils and cutback bitumens	3		III	Category A	
2000	CELLULOID in block, rods, rolls, sheets, tubes, etc., except scrap	4.1		III	Category A	
2001	COBALT NAPHTHENATES, POWDER	4.1		III	Category A	
2002	CELLULOID, SCRAP	4.2		III	Category D	
2004	MAGNESIUM DIAMIDE	4.2		II	Category C	
2006	PLASTICS, NITROCELLULOSE-BASED, SELF-HEATING, N.O.S.	4.2		III	Category C	
2008	ZIRCONIUM POWDER, DRY	4.2		I	Category D	
2008	ZIRCONIUM POWDER, DRY	4.2		II	Category D	
2008	ZIRCONIUM POWDER, DRY	4.2		III	Category D	
2009	ZIRCONIUM, DRY finished sheets, strip or coiled wire	4.2		III	Category D	
2010	MAGNESIUM HYDRIDE	4.3		I	Category E	SG35
2011	MAGNESIUM PHOSPHIDE	4.3	6.1	I	Category E SW2 SW5	SG35
2012	POTASSIUM PHOSPHIDE	4.3	6.1	I	Category E SW2 SW5	SG35
2013	STRONTIUM PHOSPHIDE	4.3	6.1	I	Category E SW2 SW5	SG35
2014	HYDROGEN PEROXIDE, AQUEOUS SOLUTION with not less than 20% but not more than 60% hydroge	5.1	8	II	Category D SW1	SG16 SG59 SG72
2015	HYDROGEN PEROXIDE, STABILIZED or HYDROGEN PEROXIDE, AQUEOUS SOLUTION, STABILIZED with mo	5.1	8	I	Category D SW1	SG16 SG59
2016	AMMUNITION, TOXIC, NON-EXPLOSIVE without burster or expelling charge, non-fuzed	6.1		II	Category E SW2 H1	
2017	AMMUNITION, TEAR-PRODUCING, NON-EXPLOSIVE without burster or expelling charge, non-fuzed	6.1		II	Category E SW2 H1	
2018	CHLOROANILINES, SOLID	6.1		II	Category A	
2019	CHLOROANILINES, LIQUID	6.1		II	Category A	SG35
2020	CHLOROPHENOLS, SOLID	6.1		III	Category A	
2021	CHLOROPHENOLS, LIQUID	6.1		III	Category A	
2022	CRESYLIC ACID	6.1	8	II	Category B	

UN Number	PROPER SHIPPING NAME (Note: When there is more than one packing group or PSN the UN No. has been annotated with a, b, c)	Class or division	Subsidiary risk(s)	Packing Group	Stowage and Handling	Segregation
2023	EPICHLOROHYDRIN	6.1	3P	II	Category A SW2	
2024	MERCURY COMPOUND, LIQUID, N.O.S.	6.1	P	I	Category B SW2	
2024	MERCURY COMPOUND, LIQUID, N.O.S.	6.1	P	II	Category B SW2	
2024	MERCURY COMPOUND, LIQUID, N.O.S.	6.1	P	III	Category B SW2	
2025	MERCURY COMPOUND, SOLID, N.O.S.	6.1	P	I	Category A	
2025	MERCURY COMPOUND, SOLID, N.O.S.	6.1	P	II	Category A	
2025	MERCURY COMPOUND, SOLID, N.O.S.	6.1	P	III	Category A	
2026	PHENYLMERCURIC COMPOUND, N.O.S.	6.1	P	I	Category A	
2026	PHENYLMERCURIC COMPOUND, N.O.S.	6.1	P	II	Category A	
2026	PHENYLMERCURIC COMPOUND, N.O.S.	6.1	P	III	Category A	
2027	SODIUM ARSENITE, SOLID	6.1		II	Category A	
2028	BOMBS, SMOKE, NON-EXPLOSIVE with corrosive liquid, without initiating device	8		II	Category E SW2	
2029	HYDRAZINE, ANHYDROUS	8	3/6.1	I	Category D SW2	SG5 SG8 SG35
2030	HYDRAZINE, AQUEOUS SOLUTION with more than 37% hydrazine, by mass	8	6.1	I	Category D SW2	SG35
2030	HYDRAZINE, AQUEOUS SOLUTION with more than 37% hydrazine, by mass	8	6.1	II	Category D SW2	SG35
2030	HYDRAZINE, AQUEOUS SOLUTION with more than 37% hydrazine, by mass	8	6.1	III	Category D SW2	SG35
2031	NITRIC ACID other than red fuming, with more than 70% nitric acid	8	5.1	I	Category D	SG6 SG16 SG17 SG19
2031	NITRIC ACID other than red fuming, with at least 65% but not more than 70% nitric acid	8	5.1	II	Category D	SG6 SG16 SG17 SG19
2031	NITRIC ACID other than red fuming, with less than 65% nitric acid	8		II	Category D	
2032	NITRIC ACID, RED FUMING	8	5.1/6.1	I	Category D SW2	SG6 SG16 SG17 SG19
2033	POTASSIUM MONOXIDE	8		II	Category A	SG22 SG35
2034	HYDROGEN AND METHANE MIXTURE, COMPRESSED	2.1			Category E SW2	SG46
2035	1,1,1-TRIFLUOROETHANE (REFRIGERANT GAS R 143a)	2.1			Category B SW2	
2036	XENON	2.2			Category A	
2037	RECEPTACLES, SMALL, CONTAINING GAS (GAS CARTRIDGES) without a release device, non refill	2			Category B SW2	
2038	DINITROTOLUENES, LIQUID	6.1		II	Category A	
2044	2,2-DIMETHYLPROPANE	2.1			Category E SW2	
2045	ISOBUTYL ALDEHYDE (ISOBUTYRALDEHYDE)	3		II	Category E SW2	

UN Number	PROPER SHIPPING NAME (Note: When there is more than one packing group or PSN the UN No. has been annotated with a, b, c)	Class or division	Subsidiary risk(s)	Packing Group	Stowage and Handling	Segregation
2046	CYMENES	3	P	III	Category A	
2047	DICHLOROPROPENES	3		II	Category B	
2047	DICHLOROPROPENES	3		III	Category A	
2048	DICYCLOPENTADIENE	3		III	Category A	
2049	DIETHYLBENZENES	3		III	Category A	
2050	DIISOBUTYLENES, ISOMERIC COMPOUNDS	3		II	Category B	
2051	2-DIMETHYLAMINOETHANOL	8	3	II	Category A	
2052	DIPENTENE	3	P	III	Category A	
2053	METHYL ISOBUTYL CARBINOL	3		III	Category A	
2054	MORPHOLINE	8	3	I	Category A	
2055	STYRENE MONOMER, STABILIZED	3		III	Category A	
2056	TETRAHYDROFURAN	3		II	Category B	
2057	TRIPROPYLENE	3		II	Category B	
2057	TRIPROPYLENE	3		III	Category A	
2058	VALERALDEHYDE	3		II	Category B	
2059	NITROCELLULOSE SOLUTION, FLAMMABLE with not more than 12.6% nitrogen, by dry mass, and n	3		I	Category E	
2059	NITROCELLULOSE SOLUTION, FLAMMABLE with not more than 12.6% nitrogen, by dry mass, and n	3		II	Category B	
2059	NITROCELLULOSE SOLUTION, FLAMMABLE with not more than 12.6% nitrogen, by dry mass, and n	3		III	Category A	
2067	AMMONIUM NITRATE BASED FERTILIZER	5.1		III	Category C SW1 SW14 SW23	SG16 SG42 SG45 SG47 SG48 SG51 SG56 SG58 SG59 SG61
2071	AMMONIUM NITRATE BASED FERTILIZER	9		III	Category A SW26	
2073	AMMONIA SOLUTION relative density less than 0.880 at 15°C in water, with more than 35% b	2.2			Category E SW2	SG35 SG46
2074	ACRYLAMIDE, SOLID	6.1		III	Category A SW1 H2	
2075	CHLORAL, ANHYDROUS, STABILIZED	6.1		II	Category D SW2	
2076	CRESOLS, LIQUID	6.1	8	II	Category B	
2077	alpha-NAPHTHYLAMINE	6.1		III	Category A	
2078	TOLUENE DIISOCYANATE	6.1		II	Category C SW1 SW2	
2079	DIETHYLENETRIAMINE	8		II	Category A SW2	SG35
2186	HYDROGEN CHLORIDE, REFRIGERATED LIQUID	2.3	8		-	
2187	CARBON DIOXIDE, REFRIGERATED LIQUID	2.2			Category D	
2188	ARSINE	2.3	2.1		Category D SW2	

UN Number	PROPER SHIPPING NAME (Note: When there is more than one packing group or PSN the UN No. has been annotated with a, b, c.)	Class or division	Subsidiary risk(s)	Packing Group	Stowage and Handling	Segregation
2189	DICHLOROSILANE	2.3	2.1/8		Category D SW2	SG4 SG9 SG72
2190	OXYGEN DIFLUORIDE, COMPRESSED	2.3	5.1/8		Category D SW2 H1	SG6 SG19
2191	SULPHURYL FLUORIDE	2.3			Category D SW2	
2192	GERMANE	2.3	2.1		Category D SW2	
2193	HEXAFLUOROETHANE (REFRIGERANT GAS R 116)	2.2			Category A	
2194	SELENIUM HEXAFLUORIDE	2.3	8		Category D SW2	
2195	TELLURIUM HEXAFLUORIDE	2.3	8		Category D SW2	
2196	TUNGSTEN HEXAFLUORIDE	2.3	8		Category D SW2	
2197	HYDROGEN IODIDE, ANHYDROUS	2.3	8		Category D SW2	
2198	PHOSPHORUS PENTAFLUORIDE	2.3	8		Category D SW2	
2199	PHOSPHINE	2.3	2.1		Category D SW2	
2200	PROPADIENE, STABILIZED	2.1			Category B SW2	
2201	NITROUS OXIDE, REFRIGERATED LIQUID	2.2			Category D SW2	
2202	HYDROGEN SELENIDE, ANHYDROUS	2.3	2.1		Category D SW2	
2203	SILANE	2.1			Category E SW2	SG43 SG46
2204	CARBONYL SULPHIDE	2.3			Category D SW2	
2205	ADIPONITRILE	6.1		III	Category A	
2206	ISOCYANATES, TOXIC, N.O.S. or ISOCYANATE SOLUTION, TOXIC, N.O.S.	6.1		II	Category E SW1 SW2	
2206	ISOCYANATES, TOXIC, N.O.S. or ISOCYANATE SOLUTION, TOXIC, N.O.S.	6.1		III	Category E SW1 SW2	
2208	CALCIUM HYPOCHLORITE MIXTURE, DRY with more than 10% but not more than 39% available chlorine	5.1		III	Category D SW1 SW11	SG35 SG38 SG49 SG53 SG60
2209	FORMALDEHYDE SOLUTION with not less than 25% formaldehyde	8		III	Category A	
2210	MANEB or MANEB PREPARATION with not less than 60% maneb	4.2	4.3 P	III	Category A	SG29
2211	POLYMERIC BEADS, EXPANDABLE evolving flammable vapour	9		III	Category E SW1 SW6	SG5 SG14
2212	BLUE ASBESTOS (crocidolite) or BROWN ASBESTOS (amosite, misorite)	9		II	Category A SW2	SG29
2213	PARAFORMALDEHYDE	4.1		III	Category A SW23	
2214	PHTHALIC ANHYDRIDE with more than 0.05% of maleic anhydride	8		III	Category A	

UN Number	PROPER SHIPPING NAME (Note: When there is more than one packing group or PSN the UN No. has been annotated with a, b, c)	Class or division	Subsidiary risk(s)	Packing Group	Stowage and Handling	Segregation
2215	MALEIC ANHYDRIDE	8		III	Category A	SG50 SG57
2215	MALEIC ANHYDRIDE, MOLTEN	8		III	Category A	SG50 SG57
2216	FISHMEAL (FISHSCRAP), STABILIZED Anti-oxidant treated. Moisture content greater than 5% but not exceeding 12%, by mass. Fat content not more than 15%	9		III	Category B SW24	SG18 SG65
2217	SEED CAKE with not more than 1.5% oil and not more than 11% moisture	4.2		III	Category A SW1 SW4 H1	
2218	ACRYLIC ACID, STABILIZED	8	3	II	Category C SW1 SW2	
2219	ALLYL GLYCIDYL ETHER	3		III	Category A	
2222	ANISOLE	3		III	Category A	
2224	BENZONITRILE	6.1		II	Category A SW2	SG35
2225	BENZENESULPHONYL CHLORIDE	8		III	Category A SW2	
2226	BENZOTRICHLORIDE	8		II	Category A SW2	
2227	n-BUTYL METHACRYLATE, STABILIZED	3		III	Category A	
2232	2-CHLOROETHANAL	6.1		I	Category D SW2	
2233	CHLOROANISIDINES	6.1		III	Category A	
2234	CHLOROBENZOTRIFLUORIDES	3		III	Category A SW2	
2235	CHLOROBENZYL CHLORIDES, LIQUID	6.1	P	III	Category A	
2236	3-CHLORO-4-METHYLPHENYLISOCYANATE, LIQUID	6.1		II	Category B SW2	
2237	CHLORONITROANILINES	6.1	P	III	Category A	
2238	CHLOROTOLUENES	3		III	Category A	
2239	CHLOROTOLUIDINES, SOLID	6.1		III	Category A	
2240	CHROMOSULPHURIC ACID	8		I	Category B SW2	SG6 SG16 SG17 SG19
2241	CYCLOHEPTANE	3		II	Category B SW2	
2242	CYCLOHEPTENE	3		II	Category B	
2243	CYCLOHEXYL ACETATE	3		III	Category A	
2244	CYCLOPENTANOL	3		III	Category A	
2245	CYCLOPENTANONE	3		III	Category A	
2246	CYCLOPENTENE	3		II	Category E	
2247	n-DECANE	3		III	Category A	
2248	DI-n-BUTYLAMINE	8	3	II	Category A	
2249	DICHLORODIMETHYL ETHER, SYMMETRICAL	6.1	3	I	Category D SW2	
2250	DICHLOROPHENYL ISOCYANATES	6.1		II	Category B SW1 SW2	

UN Number	PROPER SHIPPING NAME (Note: When there is more than one packing group or PSN the UN No. has been annotated with a, b, c)	Class or division	Subsidiary risk(s)	Packing Group	Stowage and Handling	Segregation
2251	BICYCLO[2.2.1]HEPTA-2,5-DIENE, STABILIZED (2,5-NORBORNADIENE, STABILIZED)	3		II	Category D	
2252	1,2-DIMETHOXYETHANE	3		II	Category B	
2253	N,N-DIMETHYLANILINE	6.1		II	Category A	
2254	MATCHES, FUSEE	4.1		III	Category A	
2256	CYCLOHEXENE	3		II	Category E	
2257	POTASSIUM	4.3		I	Category D	SG35
2258	1,2-PROPYLENEDIAMINE	8	3	II	Category A SW2	
2259	TRIETHYLENETETRAMINE	8		II	Category B SW2	SG35
2260	TRIPROPYLAMINE	3	8	III	Category A SW2	
2261	XYLENOLS, SOLID	6.1		II	Category A	
2262	DIMETHYLCARBAOYL CHLORIDE	8		II	Category A SW2	
2263	DIMETHYLCYCLOHEXANES	3		II	Category B	
2264	N,N-DIMETHYLCYCLOHEXYLAMINE	8	3	II	Category A SW2	
2265	N,N-DIMETHYLFORMAMIDE	3		III	Category A	
2266	N,N-DIMETHYL PROPYLAMINE	3	8	II	Category B SW2	
2267	DIMETHYL THIOPHOSPHORYL CHLORIDE	6.1	8	II	Category B SW1	
2269	3,3'-IMINODIPROPYLAMINE	8		III	Category A	
2270	ETHYLAMINE, AQUEOUS SOLUTION with not less than 50% but not more than 70% ethylamine	3	8	II	Category B SW2	SG35
2271	ETHYL AMYL KETONES	3		III	Category A	
2272	N-ETHYLANILINE	6.1		III	Category A	SG17 SG35
2273	2-ETHYLANILINE	6.1		III	Category A	SG17 SG35
2274	N-ETHYL-N-BENZYLANILINE	6.1		III	Category A	
2275	2-ETHYLBUTANOL	3		III	Category A	
2276	2-ETHYLHEXYLAMINE	3	8	III	Category A SW2	
2277	ETHYL METHACRYLATE, STABILIZED	3		II	Category B	
2278	n-HEPTENE	3		II	Category B	
2279	HEXACHLOROBUTADIENE	6.1	P	III	Category A	
2280	HEXAMETHYLENEDIAMINE, SOLID	8		III	Category A SW1 H2	
2280	HEXAMETHYLENEDIAMINE, MOLTEN	8		III	Category A SW1 H2	
2281	HEXAMETHYLENE DIISOCYANATE	6.1		II	Category C SW2 H1	
2282	HEXANOLS	3		III	Category A	
2283	ISOBUTYL METHACRYLATE, STABILIZED	3		III	Category A	
2284	ISOBUTYRONITRILE	3	6.1	II	Category E SW2	

UN Number	PROPER SHIPPING NAME (Note: When there is more than one packing group or PSN the UN No. has been annotated with a, b, c)	Class or division	Subsidiary risk(s)	Packing Group	Stowage and Handling	Segregation
2285	ISOCYANATOBENZOTRIFLUORIDES	6.1	3	II	Category D SW1 SW2	
2286	PENTAMETHYLHEPTANE	3		III	Category A	
2287	ISOHEPTENES	3		II	Category B	
2288	ISOHEXENES	3		II	Category E	
2289	ISOPHORONEDIAMINE	8		III	Category A	
2290	ISOPHORONE DIISOCYANATE	6.1		III	Category B SW2	
2291	LEAD COMPOUND, SOLUBLE, N.O.S.	6.1	P	III	Category A	
2293	4-METHOXY-4-METHYLPENTAN-2-ONE	3		III	Category A	
2294	N-METHYLANILINE	6.1		III	Category A	
2295	METHYL CHLOROACETATE	6.1	3	I	Category D	
2296	METHYLCYCLOHEXANE	3		II	Category B	
2297	METHYLCYCLOHEXANONES	3		III	Category A	
2298	METHYLCYCLOPENTANE	3		II	Category B	
2299	METHYL DICHLOROACETATE	6.1		III	Category A	
2300	2-METHYL-5-ETHYLPYRIDINE	6.1		III	Category A	
2301	2-METHYLFURAN	3		II	Category E	
2302	5-METHYLHEXAN-2-ONE	3		III	Category A	
2303	ISOPROPENYLBENZENE	3		III	Category A	
2304	NAPHTHALENE, MOLTEN	4.1		III	Category C	
2305	NITROBENZENESULPHONIC ACID	8		II	Category A	
2306	NITROBENZOTRIFLUORIDES, LIQUID	6.1	P	II	Category A SW2	
2307	3-NITRO-4-CHLOROBENZOTRIFLUORIDE	6.1	P	II	Category A SW2	
2308	NITROSYLSULPHURIC ACID, LIQUID	8		II	Category D SW2	SG6 SG16 SG17 SG19
2309	OCTADIENE	3		II	Category B	
2310	PENTANE-2,4-DIONE	3	6.1	III	Category A	
2311	PHENETIDINES	6.1		III	Category A	
2312	PHENOL, MOLTEN	6.1		II	Category B SW2	
2313	PICOLINES	3		III	Category A SW2	
2315	POLYCHLORINATED BIPHENYLS, LIQUID	9	P	II	Category A	SG50
2316	SODIUM CUPROCYANIDE, SOLID	6.1	P	I	Category A	SG35
2317	SODIUM CUPROCYANIDE SOLUTION	6.1	P	I	Category B SW2	SG35
2318	SODIUM HYDROSULPHIDE with less than 25% water of crystallization	4.2		II	Category A	SG35
2319	TERPENE HYDROCARBONS, N.O.S.	3		III	Category A	
2320	TETRAETHYLENEPENTAMINE	8		III	Category A	SG35
2321	TRICHLOROBENZENES, LIQUID	6.1	P	III	Category A	



UN Number	PROPER SHIPPING NAME (Note: When there is more than one packing group or PSN the UN No. has been annotated with a, b, c)	Class or division	Subsidiary risk(s)	Packing Group	Stowage and Handling	Segregation
2322	TRICHLOROBUTENE	6.1	P	II	Category A SW1 SW2	
2323	TRIETHYL PHOSPHITE	3		III	Category A	
2324	TRISOBUTYLENE	3		III	Category A	
2325	1,3,5-TRIMETHYLBENZENE	3		III	Category A	
2326	TRIMETHYLCYCLOHEXYLAMINE	8		III	Category A	
2327	TRIMETHYLHEXAMETHYLENEDIAMINES	8		III	Category A	
2328	TRIMETHYLHEXAMETHYLENE DIISOCYANATE	6.1		III	Category B	
2329	TRIMETHYL PHOSPHITE	3		III	Category A	
2330	UNDECANE	3		III	Category A	
2331	ZINC CHLORIDE, ANHYDROUS	8		III	Category A	
2332	ACETALDEHYDE OXIME	3		III	Category A	
2333	ALLYL ACETATE	3	6.1	II	Category E SW2	
2334	ALLYLAMINE	6.1	3	I	Category D SW2	
2335	ALLYL ETHYL ETHER	3	6.1	II	Category E SW2	
2336	ALLYL FORMATE	3	6.1	I	Category E SW2	
2337	PHENYL MERCAPTAN	6.1	3	I	Category D SW2	SG35
2338	BENZOTRIFLUORIDE	3		II	Category B SW2	
2339	2-BROMOBUTANE	3		II	Category B SW2	
2340	2-BROMOETHYL ETHYL ETHER	3		II	Category B SW2	
2341	1-BROMO-3-METHYLBUTANE	3		III	Category A	
2342	BROMOMETHYLPROPANES	3		II	Category B	
2343	2-BROMOPENTANE	3		II	Category B	
2344	BROMOPROPANES	3		II	Category B SW2	
2344	BROMOPROPANES	3		III	Category A	
2345	3-BROMOPROPYNE	3		II	Category D SW2	
2346	BUTANEDIONE	3		II	Category B	
2347	BUTYL MERCAPTANS	3		II	Category B	SG35 SG50 SG57
2348	BUTYL ACRYLATES, STABILIZED	3		III	Category A	
2350	BUTYL METHYL ETHER	3		II	Category B	
2351	BUTYL NITRITES	3		II	Category B SW2	
2351	BUTYL NITRITES	3		III	Category A SW2	
2352	BUTYL VINYL ETHER, STABILIZED	3		II	Category B SW2	
2353	BUTYRYL CHLORIDE	3	8	II	Category C SW2	

UN Number	PROPER SHIPPING NAME (Note: When there is more than one packing group or PSN the UN No. has been annotated with a, b, c)	Class or division	Subsidiary risk(s)	Packing Group	Stowage and Handling	Segregation
2354	CHLOROMETHYL ETHYL ETHER	3	6.1	II	Category E SW2	
2356	2-CHLOROPROPANE	3		I	Category E	
2357	CYCLOHEXYLAMINE	8	3	II	Category A SW2	
2358	CYCLOOCTATETRAENE	3		II	Category B	
2359	DIALLYLAMINE	3	6.1/8	II	Category B SW2	SG5 SG8
2360	DIALLYL ETHER	3	6.1	II	Category E	
2361	DIISOBUTYLAMINE	3	8	III	Category A	
2362	1,1-DICHLOROETHANE	3		II	Category B SW2	
2363	ETHYL MERCAPTAN	3	P	I	Category E	SG50 SG57
2364	n-PROPYLBENZENE	3		III	Category A	
2366	DIETHYL CARBONATE	3		III	Category A	
2367	alpha-METHYLVALERALDEHYDE	3		II	Category B	
2368	alpha-PINENE	3		III	Category A	
2370	1-HEXENE	3		II	Category E	
2371	ISOPENTENES	3		I	Category E	
2372	1,2-DI(DIMETHYLAMINO)ETHANE	3		II	Category B	
2373	DIETHOXYMETHANE	3		II	Category B	
2374	3,3-DIETHOXYPROPENE	3		II	Category B	
2375	DIETHYL SULPHIDE	3		II	Category E	
2376	2,3-DIHYDROPYRAN	3		II	Category B	
2377	1,1-DIMETHOXYETHANE	3		II	Category B	
2378	2-DIMETHYLAMINOACETONITRILE	3	6.1	II	Category A SW2	SG35
2379	1,3-DIMETHYLBUTYLAMINE	3		II	Category B	SG35
2380	DIMETHYLDIETHOXYSILOXANE	3		II	Category B	
2381	DIMETHYL DISULPHIDE	3	6.1	II	Category B SW2	
2382	DIMETHYLHYDRAZINE, SYMMETRICAL	6.1	3P	I	Category D SW2	SG17 SG35
2383	DIPROPYLAMINE	3	8	II	Category B	
2384	DI-n-PROPYL ETHER	3		II	Category B	
2385	ETHYL ISOBUTYRATE	3		II	Category B	
2386	1-ETHYLPYPERIDINE	3	8	II	Category B	SG35
2387	FLUOROBENZENE	3		II	Category B	
2388	FLUOROTOLUENES	3		II	Category B	
2389	FURAN	3		I	Category E SW2	
2390	2-IODOBUTANE	3		II	Category B	
2391	IODOMETHYLPROPANES	3		II	Category B	
2392	IODOPROPANES	3		III	Category A	
2393	ISOBUTYL FORMATE	3		II	Category B	
2394	ISOBUTYL PROPIONATE	3		III	Category B	

UN Number	PROPER SHIPPING NAME (Note: When there is more than one packing group or PSN the UN No. has been annotated with a, b, c)	Class or division	Subsidiary risk(s)	Packing Group	Stowage and Handling	Segregation
2395	ISOBUTYRYL CHLORIDE	3	8	II	Category C SW2	
2396	METHACRYLALDEHYDE, STABILIZED	3	6.1	II	Category E SW2	
2397	3-METHYLBUTAN-2-ONE	3		II	Category B	
2398	METHYL tert-BUTYL ETHER	3		II	Category E	
2399	1-METHYLPYPERIDINE	3	8	II	Category B	SG35
2400	METHYL ISOVALERATE	3		II	Category B	
2401	PIPERIDINE	8	3	I	Category D	SG35
2402	PROPANETHIOLS	3		II	Category E	SG50 SG57
2403	ISOPROPENYL ACETATE	3		II	Category B	
2404	PROPIONITRILE	3	6.1	II	Category E SW2	
2405	ISOPROPYL BUTYRATE	3		III	Category A	
2406	ISOPROPYL ISOBUTYRATE	3		II	Category B	
2407	ISOPROPYL CHLOROFORMATE	6.1	*3/8	I	Category D SW2	SG5 SG8
2409	ISOPROPYL PROPIONATE	3		II	Category B	
2410	1,2,3,6-TETRAHYDROPYRIDINE	3		II	Category B	
2411	BUTYRONITRILE	3	6.1	II	Category E SW2	
2412	TETRAHYDROTHIOPHENE	3		II	Category B	
2413	TETRAPROPYL ORTHOTITANATE	3		III	Category A	
2414	THIOPHENE	3		II	Category B SW2	
2416	TRIMETHYL BORATE	3		II	Category B	
2417	CARBONYL FLUORIDE	2.3			Category D SW2	
2418	SULPHUR TETRAFLUORIDE	2.3	8		Category D SW2	SG35
2419	BROMOTRIFLUOROETHYLENE	2.1			Category B SW2	
2420	HEXAFLUOROACETONE	2.3	8		Category D SW2	
2421	NITROGEN TRIOXIDE	2.3	*5.1/8		Category D SW2	SG6 SG19
2422	OCTAFLUOROBUT-2-ENE (REFRIGERANT GAS R 1318)	2.2			Category A	
2424	OCTAFLUOROPROPANE (REFRIGERANT GAS R 218)	2.2			Category A	
2426	AMMONIUM NITRATE, LIQUID (hot concentrated solution)	5.1			Category D	SG42 SG45 SG47 SG48 SG51 SG56 SG58 SG59 SG61
2427	POTASSIUM CHLORATE, AQUEOUS SOLUTION	5.1		II	Category B	SG38 SG49 SG62
2427	POTASSIUM CHLORATE, AQUEOUS SOLUTION	5.1		III	Category B	SG38 SG49 SG62

UN Number	PROPER SHIPPING NAME (Note: When there is more than one packing group or PSN the UN No. has been annotated with a, b, c)	Class or division	Subsidiary risk(s)	Packing Group	Stowage and Handling	Segregation
2428	SODIUM CHLORATE, AQUEOUS SOLUTION	5.1		II	Category B	SG38 SG49 SG62
2428	SODIUM CHLORATE, AQUEOUS SOLUTION	5.1		III	Category B	SG38 SG49 SG62
2429	CALCIUM CHLORATE, AQUEOUS SOLUTION	5.1		II	Category B	SG38 SG49 SG62
2429	CALCIUM CHLORATE, AQUEOUS SOLUTION	5.1		III	Category B	SG38 SG49 SG62
2430	ALKYLPHENOLS, SOLID, N.O.S. (including C2-C12 homologues)	8		I	Category B	
2430	ALKYLPHENOLS, SOLID, N.O.S. (including C2-C12 homologues)	8		II	Category B	
2430	ALKYLPHENOLS, SOLID, N.O.S. (including C2-C12 homologues)	8		III	Category A	
2431	ortho-ANISIDINE	6.1		III	Category A	
2432	N,N-DIETHYLANILINE	6.1		III	Category A	
2433	CHLORONITROTOLUENES, LIQUID	6.1	P	III	Category A	SG6 SG8 SG10 SG12
2434	DIBENZYL-DICHLOROSILANE	8		II	Category C SW2	
2435	ETHYLPHENYL-DICHLOROSILANE	8		II	Category C	
2436	THIOACETIC ACID	3		II	Category B	
2437	METHYLPHENYL-DICHLOROSILANE	8		II	Category C SW2	
2438	TRIMETHYLACETYL CHLORIDE	6.1	*3/8	I	Category D SW1 SW2	SG5 SG8
2439	SODIUM HYDROGEN DIFLUORIDE	8		II	Category A SW1 SW2 H2	SG35
2440	STANNIC CHLORIDE PENTAHYDRATE	8		III	Category A	
2441	TITANIUM TRICHLORIDE, PYROPHORIC or TITANIUM TRICHLORIDE MIXTURE, PYROPHORIC	4.2	8	I	Category D SW2	
2442	TRICHLOROACETYL CHLORIDE	8		II	Category D SW2	
2443	VANADIUM OXYTRICHLORIDE	8		II	Category C SW2	
2444	VANADIUM TETRACHLORIDE	8		I	Category C SW2	
2446	NITROCRESOLS, SOLID	6.1		III	Category A	
2447	PHOSPHORUS, WHITE, MOLTEN	4.2	6.1P	I	Category D	
2448	SULPHUR, MOLTEN	4.1		III	Category C	SG17
2451	NITROGEN TRIFLUORIDE	2.2	5.1		Category D SW2	
2452	ETHYLACETYLENE, STABILIZED	2.1			Category B SW2	
2453	ETHYL FLUORIDE (REFRIGERANT GAS R 161)	2.1			Category E SW2	

UN Number	PROPER SHIPPING NAME (Note: When there is more than one packing group or PSN the UN No. has been annotated with a, b, c)	Class or division	Subsidiary risk(s)	Packing Group	Stowage and Handling	Segregation
2454	METHYL FLUORIDE (REFRIGERANT GAS R 41)	2.1			Category E SW2	
2455	METHYL NITRITE	2.2			-	
2456	2-CHLOROPROPENE	3		I	Category E	
2457	2,3-DIMETHYLBUTANE	3		II	Category E	
2458	HEXADIENES	3		II	Category B	
2459	2-METHYL-1-BUTENE	3		I	Category E	
2460	2-METHYL-2-BUTENE	3		II	Category E	
2461	METHYLPENTADIENES	3		II	Category E	
2463	ALUMINIUM HYDRIDE	4.3		I	Category E	
2464	BERYLLIUM NITRATE	5.1	6.1	II	Category A	
2465	DICHLOROISOCYANURIC ACID, DRY or DICHLOROISOCYANURIC ACID, SALTS	5.1		II	Category A H1	
2466	POTASSIUM SUPEROXIDE	5.1		I	Category E H1	SG16 SG35 SG59
2468	TRICHLOROISOCYANURIC ACID, DRY	5.1		II	Category A H1	
2469	ZINC BROMATE	5.1		III	Category A	SG38 SG49
2470	PHENYLACETONITRILE, LIQUID	6.1		III	Category A	SG35
2471	OSMIUM TETROXIDE	6.1		I	Category B SW2	
2473	SODIUM ARSANILATE	6.1		III	Category A	
2474	THIOPHOSGENE	6.1		I	Category D SW2	SG35
2475	VANADIUM TRICHLORIDE	8		III	Category A SW2	
2477	METHYL ISOTHIOCYANATE	6.1	3	I	Category D SW2	
2478	ISOCYANATES, FLAMMABLE, TOXIC, N.O.S. or ISOCYANATE SOLUTION, FLAMMABLE, TOXIC, N.O.S.	3	6.1	II	Category D SW2	
2478	ISOCYANATES, FLAMMABLE, TOXIC, N.O.S. or ISOCYANATE SOLUTION, FLAMMABLE, TOXIC, N.O.S.	3	6.1	III	Category A	
2480	METHYL ISOCYANATE	6.1	3	I	Category D SW2	SG35
2481	ETHYL ISOCYANATE	6.1	3	I	Category D SW2	SG35
2482	n-PROPYL ISOCYANATE	6.1	3	I	Category D SW2	
2483	ISOPROPYL ISOCYANATE	6.1	3	I	Category D SW2	
2484	tert-BUTYL ISOCYANATE	6.1	3	I	Category D SW2	
2485	n-BUTYL ISOCYANATE	6.1	3	I	Category D SW2	
2486	ISOBUTYL ISOCYANATE	6.1	3	I	Category D SW2	
2487	PHENYL ISOCYANATE	6.1	3	I	Category D SW2	
2488	CYCLOHEXYL ISOCYANATE	6.1	3	I	Category D SW2	

UN Number	PROPER SHIPPING NAME (Note: When there is more than one packing group or PSN the UN No. has been annotated with a, b, c.)	Class or division	Subsidiary risk(s)	Packing Group	Stowage and Handling	Segregation
2490	DICHLOROISOPROPYL ETHER	6.1		II	Category B	
2491	ETHANOLAMINE or ETHANOLAMINE SOLUTION	8		III	Category A	SG35
2493	HEXAMETHYLENEIMINE	3	8	II	Category B SW2	
2495	IODINE PENTAFLUORIDE	5.1	*6.1/8	I	Category D SW1 SW2	SG6 SG16 SG19 SG35
2496	PROPIONIC ANHYDRIDE	8		III	Category A	
2498	1,2,3,6- TETRAHYDROBENZALDEHYDE	3		III	Category A	
2501	TRIS-(1-AZIRIDINYL) PHOSPHINE OXIDE SOLUTION	6.1		II	Category A	
2501	TRIS-(1-AZIRIDINYL) PHOSPHINE OXIDE SOLUTION	6.1		III	Category A	
2502	VALERYL CHLORIDE	8	3	II	Category C SW2	
2503	ZIRCONIUM TETRACHLORIDE	8		III	Category A	
2504	TETRABROMOETHANE	6.1	P	III	Category A	
2505	AMMONIUM FLUORIDE	6.1		III	Category A	SG35
2506	AMMONIUM HYDROGEN SULPHATE	8		II	Category A SW2	
2507	CHLOROPLATINIC ACID, SOLID	8		III	Category A	
2508	MOLYBDENUM PENTACHLORIDE	8		III	Category C SW2	
2509	POTASSIUM HYDROGEN SULPHATE	8		II	Category A	
2511	2-CHLOROPROPIONIC ACID	8		III	Category A	
2512	AMINOPHENOLS (o-, m-, p-)	6.1		III	Category A	
2513	BROMOACETYL BROMIDE	8		II	Category C SW2	SG36
2514	BROMOBENZENE	3		III	Category A	
2515	BROMOFORM	6.1	P	III	Category A SW1 SW2 H2	
2516	CARBON TETRABROMIDE	6.1	P	III	Category A SW1	
2517	1-CHLORO-1,1- DIFLUOROETHANE (REFRIGERANT GAS R 142b)	2.1			Category B SW2	
2518	1,5,9-CYCLODODECATRIENE	6.1		III	Category A SW2	
2520	CYCLOOCTADIENES	3		III	Category A	
2521	DIKETENE, STABILIZED	6.1	3	I	Category D SW2	SG20 SG21
2522	2-DIMETHYLAMINOETHYL METHACRYLATE	6.1		II	Category D SW2	
2524	ETHYL ORTHOFORMATE	3		III	Category A	
2525	ETHYL OXALATE	6.1		III	Category A	
2526	FURFURYLAMINE	3	8	III	Category A SW2	
2527	ISOBUTYL ACRYLATE, STABILIZED	3		III	Category A	
2528	ISOBUTYL ISOBUTYRATE	3		III	Category A	
2529	ISOBUTYRIC ACID	3	8	III	Category A	

UN Number	PROPER SHIPPING NAME (Note: When there is more than one packing group or PSN the UN No. has been annotated with a, b, c)	Class or division	Subsidiary risk(s)	Packing Group	Stowage and Handling	Segregation
2531	METHACRYLIC ACID, STABILIZED	8		II	Category C SW2	
2533	METHYL TRICHLOROACETATE	6.1		III	Category A	
2534	METHYLCHLOROSILANE	2.3	2.1/8		Category D SW2	SG4 SG9
2535	4-METHYLMORPHOLINE (N-METHYLMORPHOLINE)	3	8	II	Category B SW2	
2536	METHYLTETRAHYDROFURAN	3		II	Category B	
2538	NITRONAPHTHALENE	4.1		III	Category A	
2541	TERPINOLENE	3		III	Category A	
2542	TRIBUTYLAMINE	6.1		II	Category A	
2545	HAFNIUM POWDER, DRY	4.2		I	Category D	
2545	HAFNIUM POWDER, DRY	4.2		II	Category D	
2545	HAFNIUM POWDER, DRY	4.2		III	Category D	
2546	TITANIUM POWDER, DRY	4.2		I	Category D	
2546	TITANIUM POWDER, DRY	4.2		II	Category D	
2546	TITANIUM POWDER, DRY	4.2		III	Category D	
2547	SODIUM SUPEROXIDE	5.1		I	Category E H1	SG16 SG35 SG59
2548	CHLORINE PENTAFLUORIDE	2.3	5.1/8		Category D SW2	SG6 SG19
2552	HEXAFLUOROACETONE HYDRATE, LIQUID	6.1		II	Category B SW2	
2554	METHYLALLYL CHLORIDE	3		II	Category E	
2555	NITROCELLULOSE WITH WATER (not less than 25% water, by mass)	4.1		II	Category E	SG7 SG30
2556	NITROCELLULOSE WITH ALCOHOL (not less than 25% alcohol, by mass, and not more than 12.6%)	4.1		II	Category D	SG7 SG30
2557	NITROCELLULOSE with not more than 12.6% nitrogen, by dry mass, MIXTURE WITH or WITHOUT PLASTICIZER, WITH or WITHOUT PIGMENT	4.1		II	Category D	SG7 SG30
2558	EPIBROMOHYDRIN	6.1	3P	I	Category D SW2	
2560	2-METHYLPENTAN-2-OL	3		III	Category A	
2561	3-METHYL-1-BUTENE	3		I	Category E	
2564	TRICHLOROACETIC ACID SOLUTION	8		II	Category B	
2564	TRICHLOROACETIC ACID SOLUTION	8		III	Category B	
2565	DICYCLOHEXYLAMINE	8		III	Category A	
2567	SODIUM PENTACHLOROPHENATE	6.1	P	II	Category A	
2570	CADMIUM COMPOUND	6.1		I	Category A	
2570	CADMIUM COMPOUND	6.1		II	Category A	
2570	CADMIUM COMPOUND	6.1		III	Category A	
2571	ALKYLSULPHURIC ACIDS	8		II	Category C SW15	
2572	PHENYLHYDRAZINE	6.1		II	Category A SW2	
2573	THALLIUM CHLORATE	5.1	6.1P	II	Category A	SG38 SG49

UN Number	PROPER SHIPPING NAME (Note: When there is more than one packing group or PSN the UN No. has been annotated with a, b, c)	Class or division	Subsidiary risk(s)	Packing Group	Stowage and Handling	Segregation
2574	TRICRESYL PHOSPHATE with more than 3% ortho-isomer	6.1	P	II	Category A	
2576	PHOSPHORUS OXYBROMIDE, MOLTEN	8		II	Category C SW2	
2577	PHENYLACETYL CHLORIDE	8		II	Category C SW2	
2578	PHOSPHORUS TRIOXIDE	8		III	Category A SW1 H2	
2579	PIPERAZINE	8		III	Category A SW1 H2	SG35
2580	ALUMINIUM BROMIDE SOLUTION	8		III	Category A	
2581	ALUMINIUM CHLORIDE SOLUTION	8		III	Category A	
2582	FERRIC CHLORIDE SOLUTION	8		III	Category A	
2583	ALKYLSULPHONIC ACIDS, SOLID or ARYLSULPHONIC ACIDS, SOLID with more than 5% free sulphur	8		II	Category A	
2584	ALKYLSULPHONIC ACIDS, LIQUID or ARYLSULPHONIC ACIDS, LIQUID with more than 5% free sulphur	8		II	Category B	
2585	ALKYLSULPHONIC ACIDS, SOLID or ARYLSULPHONIC ACIDS, SOLID with not more than 5% free sulphur	8		III	Category A	
2586	ALKYLSULPHONIC ACIDS, LIQUID or ARYLSULPHONIC ACIDS, LIQUID with not more than 5% free sulphur	8		III	Category B	
2587	BENZOQUINONE	6.1		II	Category A	
2588	PESTICIDE, SOLID, TOXIC, N.O.S.	6.1		I	Category A SW2	
2588	PESTICIDE, SOLID, TOXIC, N.O.S.	6.1		II	Category A SW2	
2588	PESTICIDE, SOLID, TOXIC, N.O.S.	6.1		III	Category A SW2	
2589	VINYL CHLOROACETATE	6.1	3	II	Category A	
2590	WHITE ASBESTOS (chrysotile, actinolite, anthophyllite, tremolite)	9		III	Category A SW2	SG29
2591	XENON, REFRIGERATED LIQUID	2.2			Category D	
2599	CHLOROTRIFLUOROMETHANE AND TRIFLUOROMETHANE AZEOTROPIC MIXTURE with approximately 60% chloro	2.2			Category A	
2601	CYCLOBUTANE	2.1			Category B SW2	
2602	DICHLORODIFLUOROMETHANE AND DIFLUOROETHANE AZEOTROPIC MIXTURE with approximately 74% dichloro	2.2			Category A	
2603	CYCLOHEPTATRIENE	3	6.1	II	Category E SW2	
2604	BORON TRIFLUORIDE DIETHYL ETHERATE	8	3	I	Category D SW2	
2605	METHOXYMETHYL ISOCYANATE	6.1	3	I	Category D SW2	
2606	METHYL ORTHOSILICATE	6.1	3	I	Category D SW2	
2607	ACROLEIN DIMER, STABILIZED	3		III	Category A SW2	
2608	NITROPROPANES	3		III	Category A	
2609	TRIALLYL BORATE	6.1		III	Category A H1	



UN Number	PROPER SHIPPING NAME (Note: When there is more than one packing group or PSN the UN No. has been annotated with a, b, c)	Class or division	Subsidiary risk(s)	Packing Group	Stowage and Handling	Segregation
2610	TRIALLYLAMINE	3	8	III	Category A SW2	
2611	PROPYLENE CHLOROHYDRIN	6.1	3	II	Category A SW1 SW2 H2	
2612	METHYL PROPYL ETHER	3		II	Category E SW2	
2614	METHALLYL ALCOHOL	3		III	Category A	
2615	ETHYL PROPYL ETHERS	3		II	Category E	
2616	TRISOPROPYL BORATE	3		II	Category B	
2616	TRISOPROPYL BORATE	3		III	Category A	
2617	METHYLCYCLOHEXANOLS flammable	3		III	Category A	
2618	VINYLTOLUENES, STABILIZED	3		III	Category A	
2619	BENZYLDIMETHYLAMINE	8	3	II	Category A SW1 SW2	
2620	AMYL BUTYRATES	3		III	Category A	
2621	ACETYL METHYL CARBINOL	3		III	Category A	
2622	GLYCIDALDEHYDE	3	6.1	II	Category A SW2	
2623	FIRELIGHTERS, SOLID with flammable liquid	4.1		III	Category A	SG35
2624	MAGNESIUM SILICIDE	4.3		II	Category B SW5 H1	
2626	CHLORIC ACID, AQUEOUS SOLUTION with not more than 10% chloric acid	5.1		II	Category D	SG38 SG49
2627	NITRITES, INORGANIC, N.O.S.	5.1		II	Category A	SG38 SG49 SG62
2628	POTASSIUM FLUOROACETATE	6.1		I	Category E	
2629	SODIUM FLUOROACETATE	6.1		I	Category E	
2630	SELENATES or SELENITES	6.1		I	Category E	
2642	FLUOROACETIC ACID	6.1		I	Category E	
2643	METHYL BROMOACETATE	6.1		II	Category D SW2	
2644	METHYL IODIDE	6.1		I	Category D SW1 SW2 H2	
2645	PHENACYL BROMIDE	6.1		II	Category B SW2	
2646	HEXACHLOROCYCLOPENTADIE NE	6.1		I	Category D SW2	
2647	MALONONITRILE	6.1		II	Category A SW1 H2	
2648	1,2-DIBROMOBUTAN-3-ONE	6.1		II	Category B SW2	
2649	1,3-DICHLOROACETONE	6.1		II	Category B SW1 SW2 H2	
2650	1,1-DICHLORO-1-NITROETHANE	6.1		II	Category A SW1 SW2 H2	SG17

UN Number	PROPER SHIPPING NAME (Note: When there is more than one packing group or PSN the UN No. has been annotated with a, b, c)	Class or division	Subsidiary risk(s)	Packing Group	Stowage and Handling	Segregation
2651	4,4'-DIAMINODIPHENYLMETHANE	6.1	P	III	Category A	
2653	BENZYL IODIDE	6.1		II	Category B SW2 H2	
2655	POTASSIUM FLUOROSILICATE	6.1		III	Category A	SG35
2656	QUINOLINE	6.1		III	Category A SW1 H2	
2657	SELENIUM DISULPHIDE	6.1		II	Category A	
2659	SODIUM CHLOROACETATE	6.1		III	Category A	
2660	NITROTOLUIDINES (MONO)	6.1		III	Category A	
2661	HEXACHLOROACETONE	6.1		III	Category B SW1 SW2 H2	
2664	DIBROMOMETHANE	6.1		III	Category A	
2667	BUTYLTOLUENES	6.1		III	Category A	
2668	CHLOROACETONITRILE	6.1	3	I	Category D SW1 SW2 H2	SG35
2669	CHLOROCRESOLS SOLUTION	6.1		II	Category A SW1 H2	
2669	CHLOROCRESOLS SOLUTION	6.1		III	Category A SW1 H2	
2670	CYANURIC CHLORIDE	8		II	Category A SW1 SW2 H2	
2671	AMINOPYRIDINES (o-, m-, p-)	6.1		II	Category B SW1 SW2 H2	SG35
2672	AMMONIA SOLUTION relative density between 0.880 and 0.957 at 15°C in water, with more than 10% but not more than 35% ammonia	8		III	Category A SW2 SW5	SG35
2673	2-AMINO-4-CHLOROPHENOL	6.1		II	Category A	
2674	SODIUM FLUOROSILICATE	6.1		III	Category A	SG35
2676	STIBINE	2.3	2.1		Category D SW2	
2677	RUBIDIUM HYDROXIDE SOLUTION	8		II	Category A	SG22 SG35
2677	RUBIDIUM HYDROXIDE SOLUTION	8		III	Category A	SG22 SG35
2678	RUBIDIUM HYDROXIDE, SOLID	8		II	Category A	SG22 SG35
2679	LITHIUM HYDROXIDE SOLUTION	8		II	Category A	SG22 SG35
2679	LITHIUM HYDROXIDE SOLUTION	8		III	Category A	SG22 SG35
2680	LITHIUM HYDROXIDE	8		II	Category A	SG35
2681	CAESIUM HYDROXIDE SOLUTION	8		II	Category A	SG22 SG35
2681	CAESIUM HYDROXIDE SOLUTION	8		III	Category A	SG22 SG35
2682	CAESIUM HYDROXIDE	8		II	Category A	SG22 SG35

UN Number	PROPER SHIPPING NAME (Note: When there is more than one packing group or PSN the UN No. has been annotated with a, b, c.)	Class or division	Subsidiary risk(s)	Packing Group	Stowage and Handling	Segregation
2683	AMMONIUM SULPHIDE SOLUTION	8	3/6.1	II	Category B SW1 H2	SG35 SG68
2684	3-DIETHYLAMINOPROPYLAMINE	3	8	III	Category A	
2685	N,N-DIETHYLETHYLENEDIAMINE	8	3	II	Category A	
2686	2-DIETHYLAMINOETHANOL	8	3	II	Category A	
2687	DICYCLOHEXYLAMMONIUM NITRITE	4.1		III	Category A	
2688	1-BROMO-3-CHLOROPROPANE	6.1		III	Category A	
2689	GLYCEROL-alpha-MONOCHELOROXYDRIN	6.1		III	Category A	
2690	N,n-BUTYLIMIDAZOLE	6.1		II	Category A	
2691	PHOSPHORUS PENTABROMIDE	8		II	Category B SW1 SW2 H2	SG36 SG37
2692	BORON TRIBROMIDE	8		I	Category C SW1 H2	
2693	BISULPHITES, AQUEOUS SOLUTION, N.O.S.	8		III	Category A SW2	SG35
2698	TETRAHYDROPHTHALIC ANHYDRIDES with more than 0.05% maleic anhydride	8		III	Category A	
2699	TRIFLUOROACETIC ACID	8		I	Category B SW1 SW2 H2	
2705	1-PENTOL	8		II	Category B	SG20 SG21
2707	DIMETHYLDIOXANES	3		II	Category B	
2707	DIMETHYLDIOXANES	3		III	Category A	
2709	BUTYLBENZENES	3		III	Category A	
2710	DIPROPYL KETONE	3		III	Category A	
2713	ACRIDINE	6.1		III	Category A	
2714	ZINC RESINATE	4.1		III	Category A	
2715	ALUMINIUM RESINATE	4.1		III	Category A	
2716	1,4-BUTYNYEDIOL	6.1		III	Category A	SG35 SG36 SG55
2717	CAMPHOR synthetic	4.1		III	Category A	
2719	BARIIUM BROMATE	5.1	6.1	II	Category A	SG38 SG49
2720	CHROMIUM NITRATE	5.1		III	Category A	
2721	COPPER CHLORATE	5.1		II	Category A	SG38 SG49
2722	LITHIUM NITRATE	5.1		III	Category A	
2723	MAGNESIUM CHLORATE	5.1		II	Category A	SG38 SG49
2724	MANGANESE NITRATE	5.1		III	Category A	
2725	NICKEL NITRATE	5.1		III	Category A	
2726	NICKEL NITRITE	5.1		III	Category A	SG38 SG49
2727	THALLIUM NITRATE	6.1	5.1P	II	Category A	
2728	ZIRCONIUM NITRATE	5.1		III	Category A	

UN Number	PROPER SHIPPING NAME (Note: When there is more than one packing group or PSN the UN No. has been annotated with a, b, c)	Class or division	Subsidiary risk(s)	Packing Group	Stowage and Handling	Segregation
2729	HEXACHLOROBENZENE	6.1		III	Category A	
2730	NITROANISOLE, LIQUID	6.1		III	Category A	
2732	NITROBROMOBENZENES, LIQUID	6.1		III	Category A	
2733	AMINES, FLAMMABLE, CORROSIVE, N.O.S. or POLYAMINES, FLAMMABLE, CORROSIVE, N.O.S.	3	8	I	Category D SW2	SG35
2733	AMINES, FLAMMABLE, CORROSIVE, N.O.S. or POLYAMINES, FLAMMABLE, CORROSIVE, N.O.S.	3	8	II	Category B SW2	SG35
2733	AMINES, FLAMMABLE, CORROSIVE, N.O.S. or POLYAMINES, FLAMMABLE, CORROSIVE, N.O.S.	3	8	III	Category A SW2	SG35
2734	AMINES, LIQUID, CORROSIVE, FLAMMABLE, N.O.S. or POLYAMINES, LIQUID, CORROSIVE, FLAMMABLE	8	3	I	Category A	SG35
2734	AMINES, LIQUID, CORROSIVE, FLAMMABLE, N.O.S. or POLYAMINES, LIQUID, CORROSIVE, FLAMMABLE	8	3	II	Category A	SG35
2735	AMINES, LIQUID, CORROSIVE, N.O.S. or POLYAMINES, LIQUID, CORROSIVE, N.O.S.	8		I	Category A	SG35
2735	AMINES, LIQUID, CORROSIVE, N.O.S. or POLYAMINES, LIQUID, CORROSIVE, N.O.S.	8		II	Category A	SG35
2735	AMINES, LIQUID, CORROSIVE, N.O.S. or POLYAMINES, LIQUID, CORROSIVE, N.O.S.	8		III	Category A	SG35
2738	N-BUTYLANILINE	6.1		II	Category A	SG17
2739	BUTYRIC ANHYDRIDE	8		III	Category A	
2740	n-PROPYL CHLOROFORMATE	6.1	*3/8	I	Category B SW2	SG5 SG8
2741	BARIUM HYPOCHLORITE with more than 22% available chlorine	5.1	6.1	II	Category B	SG35 SG38 SG49 SG53 SG60
2742	CHLOROFORMATES, TOXIC, CORROSIVE, FLAMMABLE, N.O.S.	6.1		II	Category A SW1 SW2 H1 H2	SG5 SG8
2743	n-BUTYL CHLOROFORMATE	6.1	*3/8	II	Category A SW1 SW2 H1 H2	SG5 SG8
2744	CYCLOBUTYL CHLOROFORMATE	6.1	*3/8	II	Category A SW1 SW2 H1 H2	SG5 SG8
2745	CHLOROMETHYL CHLOROFORMATE	6.1	8	II	Category A SW1 SW2 H1 H2	
2746	PHENYL CHLOROFORMATE	6.1	8	II	Category A SW1 SW2 H1 H2	
2747	tert-BUTYLCYCLOHEXYL CHLOROFORMATE	6.1		III	Category A SW1 H1 H2	

UN Number	PROPER SHIPPING NAME (Note: When there is more than one packing group or PSN the UN No. has been annotated with a, b, c)	Class or division	Subsidiary risk(s)	Packing Group	Stowage and Handling	Segregation
2748	2-ETHYLHEXYL CHLOROFORMATE	6.1	8	II	Category A SW1 SW2 H1 H2	
2749	TETRAMETHYLSILANE	3		I	Category D	
2750	1,3-DICHLOROPROPANOL-2	6.1		II	Category A SW1 SW2 H2	
2751	DIETHYLTHIOPHOSPHORYL CHLORIDE	8		II	Category D SW1 SW2 H2	
2752	1,2-EPOXY-3-ETHOXYPROPANE	3		III	Category A	
2753	N-ETHYLBENZYL TOLUIDINES, LIQUID	6.1		III	Category A	
2754	N-ETHYL TOLUIDINES	6.1		II	Category A	
2757	CARBAMATE PESTICIDE, SOLID, TOXIC	6.1		I	Category A SW2	
2757	CARBAMATE PESTICIDE, SOLID, TOXIC	6.1		II	Category A SW2	
2757	CARBAMATE PESTICIDE, SOLID, TOXIC	6.1		III	Category A SW2	
2758	CARBAMATE PESTICIDE, LIQUID, FLAMMABLE, TOXIC flashpoint less than 23°C	3	6.1	I	Category B SW2	
2758	CARBAMATE PESTICIDE, LIQUID, FLAMMABLE, TOXIC flashpoint less than 23°C	3	6.1	II	Category B SW2	
2759	ARSENICAL PESTICIDE, SOLID, TOXIC	6.1		I	Category A SW2	
2759	ARSENICAL PESTICIDE, SOLID, TOXIC	6.1		II	Category A SW2	
2759	ARSENICAL PESTICIDE, SOLID, TOXIC	6.1		III	Category A SW2	
2760	ARSENICAL PESTICIDE, LIQUID, FLAMMABLE, TOXIC flashpoint less than 23°C	3	6.1	I	Category B SW2	
2760	ARSENICAL PESTICIDE, LIQUID, FLAMMABLE, TOXIC flashpoint less than 23°C	3	6.1	II	Category B SW2	
2761	ORGANOCHLORINE PESTICIDE, SOLID, TOXIC	6.1		I	Category A SW2	
2761	ORGANOCHLORINE PESTICIDE, SOLID, TOXIC	6.1		II	Category A SW2	
2761	ORGANOCHLORINE PESTICIDE, SOLID, TOXIC	6.1		III	Category A SW2	
2762	ORGANOCHLORINE PESTICIDE, LIQUID, FLAMMABLE, TOXIC flashpoint less than 23°C	3	6.1	I	Category B SW2	
2762	ORGANOCHLORINE PESTICIDE, LIQUID, FLAMMABLE, TOXIC flashpoint less than 23°C	3	6.1	II	Category B SW2	
2763	TRIAZINE PESTICIDE, SOLID, TOXIC	6.1		I	Category A SW2	
2763	TRIAZINE PESTICIDE, SOLID, TOXIC	6.1		II	Category A SW2	
2763	TRIAZINE PESTICIDE, SOLID, TOXIC	6.1		III	Category A SW2	
2764	TRIAZINE PESTICIDE, LIQUID, FLAMMABLE, TOXIC flashpoint less than 23°C	3	6.1	I	Category B SW2	
2764	TRIAZINE PESTICIDE, LIQUID, FLAMMABLE, TOXIC flashpoint less than 23°C	3	6.1	II	Category B SW2	

UN Number	PROPER SHIPPING NAME (Note: When there is more than one packing group or PSN the UN No. has been annotated with a, b, c)	Class or division	Subsidiary risk(s)	Packing Group	Stowage and Handling	Segregation
2771	THIOCARBAMATE PESTICIDE, SOLID, TOXIC	6.1		I	Category A SW2	
2771	THIOCARBAMATE PESTICIDE, SOLID, TOXIC	6.1		II	Category A SW2	
2771	THIOCARBAMATE PESTICIDE, SOLID, TOXIC	6.1		III	Category A SW2	
2772	THIOCARBAMATE PESTICIDE, LIQUID, FLAMMABLE, TOXIC flashpoint less than 23°C	3	6.1	I	Category B SW2	
2772	THIOCARBAMATE PESTICIDE, LIQUID, FLAMMABLE, TOXIC flashpoint less than 23°C	3	6.1	II	Category B SW2	
2775	COPPER BASED PESTICIDE, SOLID, TOXIC	6.1		I	Category A SW2	
2775	COPPER BASED PESTICIDE, SOLID, TOXIC	6.1		II	Category A SW2	
2775	COPPER BASED PESTICIDE, SOLID, TOXIC	6.1		III	Category A SW2	
2776	COPPER BASED PESTICIDE, LIQUID, FLAMMABLE, TOXIC flashpoint less than 23°C	3	6.1	I	Category B SW2	
2776	COPPER BASED PESTICIDE, LIQUID, FLAMMABLE, TOXIC flashpoint less than 23°C	3	6.1	II	Category B SW2	
2777	MERCURY BASED PESTICIDE, SOLID, TOXIC	6.1	P	I	Category A SW2	
2777	MERCURY BASED PESTICIDE, SOLID, TOXIC	6.1	P	II	Category A SW2	
2777	MERCURY BASED PESTICIDE, SOLID, TOXIC	6.1	P	III	Category A SW2	
2778	MERCURY BASED PESTICIDE, LIQUID, FLAMMABLE, TOXIC flashpoint less than 23°C	3	6.1P	I	Category B SW2	
2778	MERCURY BASED PESTICIDE, LIQUID, FLAMMABLE, TOXIC flashpoint less than 23°C	3	6.1P	II	Category B SW2	
2779	SUBSTITUTED NITROPHENOL PESTICIDE, SOLID, TOXIC	6.1		I	Category A SW2	
2779	SUBSTITUTED NITROPHENOL PESTICIDE, SOLID, TOXIC	6.1		II	Category A SW2	
2779	SUBSTITUTED NITROPHENOL PESTICIDE, SOLID, TOXIC	6.1		III	Category A SW2	
2780	SUBSTITUTED NITROPHENOL PESTICIDE, LIQUID, FLAMMABLE, TOXIC flashpoint less than 23°C	3	6.1	I	Category B SW2	
2780	SUBSTITUTED NITROPHENOL PESTICIDE, LIQUID, FLAMMABLE, TOXIC flashpoint less than 23°C	3	6.1	II	Category B SW2	
2781	BIPYRIDILUM PESTICIDE, SOLID, TOXIC	6.1		I	Category A SW2	
2781	BIPYRIDILUM PESTICIDE, SOLID, TOXIC	6.1		II	Category A SW2	
2781	BIPYRIDILUM PESTICIDE, SOLID, TOXIC	6.1		III	Category A SW2	
2782	BIPYRIDILUM PESTICIDE, LIQUID, FLAMMABLE, TOXIC flashpoint less than 23°C	3	6.1	I	Category B SW2	
2782	BIPYRIDILUM PESTICIDE, LIQUID, FLAMMABLE, TOXIC flashpoint less than 23°C	3	6.1	II	Category B SW2	
2783	ORGANOPHOSPHORUS PESTICIDE, SOLID, TOXIC	6.1		I	Category A SW2	
2783	ORGANOPHOSPHORUS PESTICIDE, SOLID, TOXIC	6.1		II	Category A SW2	

UN Number	PROPER SHIPPING NAME (Note: When there is more than one packing group or PSN the UN No. has been annotated with a, b, c)	Class or division	Subsidiary risk(s)	Packing Group	Stowage and Handling	Segregation
2783	ORGANOPHOSPHORUS PESTICIDE, SOLID, TOXIC	6.1		III	Category A SW2	
2784	ORGANOPHOSPHORUS PESTICIDE, LIQUID, FLAMMABLE, TOXIC flashpoint less than 23°C	3	6.1	I	Category B SW2	
2784	ORGANOPHOSPHORUS PESTICIDE, LIQUID, FLAMMABLE, TOXIC flashpoint less than 23°C	3	6.1	II	Category B SW2	
2785	4-THIAPENTANAL	6.1		III	Category D SW1	SG20 SG21
2786	ORGANOTIN PESTICIDE, SOLID, TOXIC	6.1	P	I	Category A SW2	
2786	ORGANOTIN PESTICIDE, SOLID, TOXIC	6.1	P	II	Category A SW2	
2786	ORGANOTIN PESTICIDE, SOLID, TOXIC	6.1	P	III	Category A SW2	
2787	ORGANOTIN PESTICIDE, LIQUID, FLAMMABLE, TOXIC flashpoint less than 23°C	3	6.1P	I	Category B SW2	
2787	ORGANOTIN PESTICIDE, LIQUID, FLAMMABLE, TOXIC flashpoint less than 23°C	3	6.1P	II	Category B SW2	
2788	ORGANOTIN COMPOUND, LIQUID, N.O.S.	6.1	P	I	Category A SW2	
2788	ORGANOTIN COMPOUND, LIQUID, N.O.S.	6.1	P	II	Category A SW2	
2788	ORGANOTIN COMPOUND, LIQUID, N.O.S.	6.1	P	III	Category A SW2	
2789	ACETIC ACID, GLACIAL or ACETIC ACID SOLUTION, more than 80% acid, by mass	8	3	II	Category A	
2790	ACETIC ACID SOLUTION not less than 50% but not more than 80% acid, by mass	8		II	Category A	
2790	ACETIC ACID SOLUTION more than 10% and less than 50% acid, by mass	8		III	Category A	
2793	FERROUS METAL BORINGS, SHAVINGS, TURNINGS, or CUTTINGS in a form liable to self-heating	4.2		III	Category A	
2794	BATTERIES, WET, FILLED WITH ACID electric storage	8			Category A SW16	
2795	BATTERIES, WET, FILLED WITH ALKALI electric storage	8			Category A SW16	SG35
2796	SULPHURIC ACID with not more than 51% acid or BATTERY FLUID, ACID	8		II	Category B	
2797	BATTERY FLUID, ALKALI	8		II	Category A	SG22 SG35
2798	PHENYLPHOSPHORUS DICHLORIDE	8		II	Category B SW2	
2799	PHENYLPHOSPHORUS THIODICHLORIDE	8		II	Category B SW2	
2800	BATTERIES, WET, NON-SPILLABLE electric storage	8			Category A	
2801	DYE, LIQUID, CORROSIVE, N.O.S. or DYE INTERMEDIATE, LIQUID, CORROSIVE, N.O.S.	8		I	Category A	
2801	DYE, LIQUID, CORROSIVE, N.O.S. or DYE INTERMEDIATE, LIQUID, CORROSIVE, N.O.S.	8		II	Category A	
2801	DYE, LIQUID, CORROSIVE, N.O.S. or DYE INTERMEDIATE, LIQUID, CORROSIVE, N.O.S.	8		III	Category A	
2802	COPPER CHLORIDE	8	P	III	Category A	
2803	GALLIUM	8		III	Category B SW1	

UN Number	PROPER SHIPPING NAME (Note: When there is more than one packing group or PSN the UN No. has been annotated with a, b, c)	Class or division	Subsidiary risk(s)	Packing Group	Stowage and Handling	Segregation
2805	LITHIUM HYDRIDE, FUSED SOLID	4.3		II	Category E	SG35
2806	LITHIUM NITRIDE	4.3		I	Category E	
2807	MAGNETIZED MATERIAL	9		III	-	
2809	MERCURY	8	6.1	III	Category B SW2	SG24
2810	TOXIC LIQUID, ORGANIC, N.O.S.	6.1		I	Category B SW2	
2810	TOXIC LIQUID, ORGANIC, N.O.S.	6.1		II	Category B SW2	
2810	TOXIC LIQUID, ORGANIC, N.O.S.	6.1		III	Category A SW2	
2811	TOXIC SOLID, ORGANIC, N.O.S.	6.1		I	Category B	
2811	TOXIC SOLID, ORGANIC, N.O.S.	6.1		II	Category B	
2811	TOXIC SOLID, ORGANIC, N.O.S.	6.1		III	Category A	
2812	SODIUM ALUMINATE, SOLID	8			-	
2813	WATER-REACTIVE SOLID, N.O.S.	4.3		I	Category E SW2	
2813	WATER-REACTIVE SOLID, N.O.S.	4.3		II	Category E SW2	
2813	WATER-REACTIVE SOLID, N.O.S.	4.3		III	Category E SW2	
2814	INFECTIOUS SUBSTANCE, AFFECTING HUMANS	6.2			SW7	
2815	N-AMINOETHYLPIPERAZINE	8		III	Category A SW1 H2	
2817	AMMONIUM HYDROGENDIFLUORIDE SOLUTION	8	6.1	II	Category B SW2	
2817	AMMONIUM HYDROGENDIFLUORIDE SOLUTION	8	6.1	III	Category B SW2	
2818	AMMONIUM POLYSULPHIDE SOLUTION	8	6.1	II	Category B SW1 SW2 H2	SG35
2818	AMMONIUM POLYSULPHIDE SOLUTION	8	6.1	III	Category B SW1 SW2 H2	SG35
2819	AMYL ACID PHOSPHATE	8		III	Category A	
2820	BUTYRIC ACID	8		III	Category A SW1 H2	
2821	PHENOL SOLUTION	6.1		II	Category A	
2821	PHENOL SOLUTION	6.1		III	Category A	
2822	2-CHLOROPYRIDINE	6.1		II	Category A SW2	
2823	CROTONIC ACID, SOLID	8		III	Category A SW1 H2	
2826	ETHYL CHLOROTHIOFORMATE	8	3P	II	Category A SW2	
2829	CAPROIC ACID	8		III	Category A	
2830	LITHIUM FERROSILICON	4.3		II	Category E SW2 SW5 H1	
2831	1,1,1-TRICHLOROETHANE	6.1		III	Category A SW2	
2834	PHOSPHOROUS ACID	8		III	Category A SW1	



UN Number	PROPER SHIPPING NAME (Note: When there is more than one packing group or PSN the UN No. has been annotated with a, b, c)	Class or division	Subsidiary risk(s)	Packing Group	Stowage and Handling	Segregation
2835	SODIUM ALUMINIUM HYDRIDE	4.3		II	Category E	SG35
2837	BISULPHATES, AQUEOUS SOLUTION	8		II	Category A	
2837	BISULPHATES, AQUEOUS SOLUTION	8		III	Category A	
2838	VINYL BUTYRATE, STABILIZED	3		II	Category B	
2839	ALDOL	6.1		II	Category A SW1 H2	
2840	BUTYRALDOXIME	3		III	Category A	
2841	DI-n-AMYLAMINE	3	6.1	III	Category A	
2842	NITROETHANE	3		III	Category A	
2844	CALCIUM MANGANESE SILICON	4.3		III	Category A SW5 H1	SG35
2845	PYROPHORIC LIQUID, ORGANIC, N.O.S.	4.2		I	Category D	SG63
2846	PYROPHORIC SOLID, ORGANIC, N.O.S.	4.2		I	Category D	
2849	3-CHLOROPROPANOL-1	6.1		III	Category A	
2850	PROPYLENE TETRAMER	3		III	Category A	
2851	BORON TRIFLUORIDE DIHYDRATE	8		II	Category B SW1 SW2 H2	
2852	DIPICRYL SULPHIDE, WETTED with not less than 10% water, by mass	4.1		I	Category D	SG7 SG30
2853	MAGNESIUM FLUOROSILICATE	6.1		III	Category A	SG35
2854	AMMONIUM FLUOROSILICATE	6.1		III	Category A	SG35
2855	ZINC FLUOROSILICATE	6.1		III	Category A	SG35
2856	FLUOROSILICATES, N.O.S.	6.1		III	Category A	SG35
2857	REFRIGERATING MACHINES containing non-flammable, non-toxic gases or ammonia solution (UN2672)	2.2			Category A	
2858	ZIRCONIUM, DRY coiled wire, finished metal sheets, strip (thinner than 254 microns but not thinner than 18 microns)	4.1		III	Category A	
2859	AMMONIUM METAVANADATE	6.1		II	Category A	SG6 SG8 SG10 SG12
2861	AMMONIUM POLYVANADATE	6.1		II	Category A	SG6 SG8 SG10 SG12
2862	VANADIUM PENTOXIDE, non-fused form	6.1		III	Category A	
2863	SODIUM AMMONIUM VANADATE	6.1		II	Category A	
2864	POTASSIUM METAVANADATE	6.1		II	Category A	
2865	HYDROXYLAMINE SULPHATE	8		III	Category A	
2869	TITANIUM TRICHLORIDE MIXTURE	8		II	Category A SW2	
2869	TITANIUM TRICHLORIDE MIXTURE	8		III	Category A SW2	
2870	ALUMINIUM BOROHYDRIDE	4.2	4.3	I	Category D	
2870	ALUMINIUM BOROHYDRIDE IN DEVICES	4.2	4.3	I	Category D	
2871	ANTIMONY POWDER	6.1		III	Category A	
2872	DIBROMOCHLOROPROPANES	6.1		II	Category A	
2872	DIBROMOCHLOROPROPANES	6.1		III	Category A	

UN Number	PROPER SHIPPING NAME (Note: When there is more than one packing group or PSN the UN No. has been annotated with a, b, c)	Class or division	Subsidiary risk(s)	Packing Group	Stowage and Handling	Segregation
2873	N,N-DI-n-BUTYLAMINOETHANOL	6.1		III	Category A	
2874	FURFURYL ALCOHOL	6.1		III	Category A	SG17 SG35
2875	HEXACHLOROPHENE	6.1		III	Category A	
2876	RESORCINOL	6.1		III	Category A	
2878	TITANIUM, SPONGE GRANULES or TITANIUM, SPONGE POWDERS	4.1		III	Category D	SG17
2879	SELENIUM OXYCHLORIDE	8	6.1	I	Category E SW2	
2880	CALCIUM HYPOCHLORITE, HYDRATED or CALCIUM HYPOCHLORITE, HYDRATED MIXTURE with not less than 5.5% but not more than 16% water	5.1		II	Category D SW1 SW11	SG35 SG38 SG49 SG53 SG60
2880	CALCIUM HYPOCHLORITE, HYDRATED or CALCIUM HYPOCHLORITE, HYDRATED MIXTURE with not less than 5.5% but not more than 16% water	5.1		III	Category D SW1 SW11	SG35 SG38 SG49 SG53 SG60
2881	METAL CATALYST, DRY	4.2		I	Category C	
2881	METAL CATALYST, DRY	4.2		II	Category C	
2881	METAL CATALYST, DRY	4.2		III	Category C	
2900	INFECTIOUS SUBSTANCE, AFFECTING ANIMALS only	6.2			SW7	
2901	BROMINE CHLORIDE	2.3	5.1/8		Category D SW2	SG6 SG19
2902	PESTICIDE, LIQUID, TOXIC, N.O.S.	6.1		I	Category B SW2	
2902	PESTICIDE, LIQUID, TOXIC, N.O.S.	6.1		II	Category B SW2	
2902	PESTICIDE, LIQUID, TOXIC, N.O.S.	6.1		III	Category A SW2	
2903	PESTICIDE, LIQUID, TOXIC, FLAMMABLE, N.O.S. flashpoint not less than 23°C	6.1	3	I	Category B SW2	
2903	PESTICIDE, LIQUID, TOXIC, FLAMMABLE, N.O.S. flashpoint not less than 23°C	6.1	3	II	Category B SW2	
2903	PESTICIDE, LIQUID, TOXIC, FLAMMABLE, N.O.S. flashpoint not less than 23°C	6.1	3	III	Category A SW2	
2904	CHLOROPHENOLATES, LIQUID or PHENOLATES, LIQUID	8		III	Category A	
2905	CHLOROPHENOLATES, SOLID or PHENOLATES, SOLID	8		III	Category A	
2907	ISOSORBIDE DINITRATE MIXTURE with not less than 60% lactose, mannose, starch, or calcium	4.1		II	Category E	SG7 SG30
2908	RADIOACTIVE MATERIAL, EXCEPTED PACKAGE - EMPTY PACKAGING	7	See SP290		Category A	
2909	RADIOACTIVE MATERIAL, EXCEPTED PACKAGE - ARTICLES MANUFACTURED FROM NATURAL URANIUM or D	7	See SP290		Category A	
2910	RADIOACTIVE MATERIAL, EXCEPTED PACKAGE - LIMITED QUANTITY OF MATERIAL	7	See SP290		Category A	
2911	RADIOACTIVE MATERIAL, EXCEPTED PACKAGE - INSTRUMENTS or ARTICLES	7	See SP290		Category A	
2912	RADIOACTIVE MATERIAL, LOW SPECIFIC ACTIVITY (LSA-I), non fissile or fissile-excepted	7	See SP172		Category A SW20	

UN Number	PROPER SHIPPING NAME (Note: When there is more than one packing group or PSN the UN No. has been annotated with a, b, c.)	Class or division	Subsidiary risk(s)	Packing Group	Stowage and Handling	Segregation
2913	RADIOACTIVE MATERIAL, SURFACE CONTAMINATED OBJECTS( SCO-I or SCO-II), non fissile or fis	7	See SP172		Category A	
2915	RADIOACTIVE MATERIAL, TYPE A PACKAGE, non-special form, non fissile or fissile-excepted	7	See SP172		Category A SW20 SW21	
2916	RADIOACTIVE MATERIAL, TYPE B(U) PACKAGE, non fissile or fissile-excepted	7	See SP172		Category A SW12	
2917	RADIOACTIVE MATERIAL, TYPE B(M) PACKAGE, non fissile or fissile-excepted	7	See SP172		Category A SW12	
2919	RADIOACTIVE MATERIAL TRANSPORTED UNDER SPECIAL ARRANGEMENT, non fissile or fissile-excep	7	See SP172		Category A SW13	
2920	CORROSIVE LIQUID, FLAMMABLE, N.O.S.	8	3	I	Category C SW1 SW2	
2920	CORROSIVE LIQUID, FLAMMABLE, N.O.S.	8	3	II	Category C SW1 SW2	
2921	CORROSIVE SOLID, FLAMMABLE, N.O.S.	8	4.1	I	Category B SW1 H2	
2921	CORROSIVE SOLID, FLAMMABLE, N.O.S.	8	4.1	II	Category B SW1 H2	
2922	CORROSIVE LIQUID, TOXIC, N.O.S.	8	6.1	I	Category B SW2	
2922	CORROSIVE LIQUID, TOXIC, N.O.S.	8	6.1	II	Category B SW2	
2922	CORROSIVE LIQUID, TOXIC, N.O.S.	8	6.1	III	Category B SW2	
2923	CORROSIVE SOLID, TOXIC, N.O.S.	8	6.1	I	Category B SW2	
2923	CORROSIVE SOLID, TOXIC, N.O.S.	8	6.1	II	Category B SW2	
2923	CORROSIVE SOLID, TOXIC, N.O.S.	8	6.1	III	Category B SW2	
2924	FLAMMABLE LIQUID, CORROSIVE, N.O.S.	3	8	I	Category E SW2	
2924	FLAMMABLE LIQUID, CORROSIVE, N.O.S.	3	8	II	Category B SW2	
2924	FLAMMABLE LIQUID, CORROSIVE, N.O.S.	3	8	III	Category A SW2	
2925	FLAMMABLE SOLID, CORROSIVE, ORGANIC, N.O.S.	4.1	8	II	Category D SW2	
2925	FLAMMABLE SOLID, CORROSIVE, ORGANIC, N.O.S.	4.1	8	III	Category D SW2	
2926	FLAMMABLE SOLID, TOXIC, ORGANIC, N.O.S.	4.1	6.1	II	Category B SW2	
2926	FLAMMABLE SOLID, TOXIC, ORGANIC, N.O.S.	4.1	6.1	III	Category B SW2	
2927	TOXIC LIQUID, CORROSIVE, ORGANIC, N.O.S.	6.1	8	I	Category B SW2	
2927	TOXIC LIQUID, CORROSIVE, ORGANIC, N.O.S.	6.1	8	II	Category B SW2	
2928	TOXIC SOLID, CORROSIVE, ORGANIC, N.O.S.	6.1	8	I	Category B SW2	
2928	TOXIC SOLID, CORROSIVE, ORGANIC, N.O.S.	6.1	8	II	Category B SW2	

UN Number	PROPER SHIPPING NAME (Note: When there is more than one packing group or PSN the UN No. has been annotated with a, b, c)	Class or division	Subsidiary risk(s)	Packing Group	Stowage and Handling	Segregation
2929	TOXIC LIQUID, FLAMMABLE, ORGANIC, N.O.S.	6.1	3	I	Category B SW2	
2929	TOXIC LIQUID, FLAMMABLE, ORGANIC, N.O.S.	6.1	3	II	Category B SW2	
2930	TOXIC SOLID, FLAMMABLE, ORGANIC, N.O.S.	6.1	4.1	I	Category B	
2930	TOXIC SOLID, FLAMMABLE, ORGANIC, N.O.S.	6.1	4.1	II	Category B	
2931	VANADYL SULPHATE	6.1		II	Category A	
2933	METHYL 2-CHLOROPROPIONATE	3		III	Category A	
2934	ISOPROPYL 2-CHLOROPROPIONATE	3		III	Category A	
2935	ETHYL 2-CHLOROPROPIONATE	3		III	Category A	
2936	THIOLACTIC ACID	6.1		II	Category A	
2937	alpha-METHYLBENZYL ALCOHOL, LIQUID	6.1		III	Category A	
2940	9-PHOSPHABICYCLONANES (CYCLOOCTADIENE PHOSPHINES)	4.2		II	Category A	
2941	FLUOROANILINES	6.1		III	Category A	
2942	2-TRIFLUOROMETHYLANILINE	6.1		III	Category A	
2943	TETRAHYDROFURFURYLAMINE	3		III	Category A	
2945	N-METHYLBUTYLAMINE	3	8	II	Category B SW2	
2946	2-AMINO-5-DIETHYLAMINOPENTANE	6.1		III	Category A	
2947	ISOPROPYL CHLOROACETATE	3		III	Category A	
2948	3-TRIFLUOROMETHYLANILINE	6.1		II	Category A SW2	
2949	SODIUM HYDROSULPHIDE, HYDRATED with not less than 25% water of crystallization	8		II	Category A	SG35
2950	MAGNESIUM GRANULES, COATED particle size not less than 149 microns	4.3		III	Category A	SG35
2956	5-tert-BUTYL-2,4,6-TRINITRO-m-XYLENE (MUSK XYLENE)	4.1		III	Category D SW1 SW2 H2 H3	SG1
2965	BORON TRIFLUORIDE DIMETHYL ETHERATE	4.3	**3/8	I	Category D SW2	SG5 SG7 SG8 SG13
2966	THIOGLYCOL	6.1		II	Category A	
2967	SULPHAMIC ACID	8		III	Category A	
2968	MANEB, STABILIZED or MANEB PREPARATION, STABILIZED against self-heating	4.3		III	Category B	SG29 SG35
2969	CASTOR BEANS or CASTOR MEAL or CASTOR POMACE or CASTOR FLAKE	9		II	Category E SW2	SG10 SG18 SG29
2977	RADIOACTIVE MATERIAL, URANIUM HEXAFLUORIDE, FISSILE	7	8		Category A SW12	
2978	RADIOACTIVE MATERIAL, URANIUM HEXAFLUORIDE non fissile or fissile-excepted	7	8		Category A SW12	
2983	ETHYLENE OXIDE AND PROPYLENE OXIDE MIXTURE with not more than 30% ethylene oxide	3	6.1	I	Category E SW2	
2984	HYDROGEN PEROXIDE, AQUEOUS SOLUTION with not less than 8% but less than 20% hydrogen peroxide (stabilized as necessary)	5.1		III	Category B SW1	SG16 SG59 SG72

UN Number	PROPER SHIPPING NAME (Note: When there is more than one packing group or PSN the UN No. has been annotated with a, b, c)	Class or division	Subsidiary risk(s)	Packing Group	Stowage and Handling	Segregation
2985	CHLOROSILANES, FLAMMABLE, CORROSIVE, N.O.S.	3	8	II	Category B SW2	
2986	CHLOROSILANES, CORROSIVE, FLAMMABLE, N.O.S.	8	3	II	Category C SW2	
2987	CHLOROSILANES, CORROSIVE, N.O.S.	8		II	Category C SW2	
2988	CHLOROSILANES, WATER-REACTIVE, FLAMMABLE, CORROSIVE, N.O.S.	4.3	*3/8	I	Category D SW2	SG5 SG7 SG8 SG13
2989	LEAD PHOSPHITE, DIBASIC	4.1		II	Category B	SG29
2989	LEAD PHOSPHITE, DIBASIC	4.1		III	Category B	SG29
2990	LIFE-SAVING APPLIANCES, SELF-INFLATING	9			Category A	SG18 SG71
2991	CARBAMATE PESTICIDE, LIQUID, TOXIC, FLAMMABLE, flashpoint not less than 23°C	6.1	3	I	Category B SW2	
2991	CARBAMATE PESTICIDE, LIQUID, TOXIC, FLAMMABLE, flashpoint not less than 23°C	6.1	3	II	Category B SW2	
2991	CARBAMATE PESTICIDE, LIQUID, TOXIC, FLAMMABLE, flashpoint not less than 23°C	6.1	3	III	Category A SW2	
2992	CARBAMATE PESTICIDE, LIQUID, TOXIC	6.1		I	Category B SW2	
2992	CARBAMATE PESTICIDE, LIQUID, TOXIC	6.1		II	Category B SW2	
2992	CARBAMATE PESTICIDE, LIQUID, TOXIC	6.1		III	Category A SW2	
2993	ARSENICAL PESTICIDE, LIQUID, TOXIC, FLAMMABLE flashpoint not less than 23°C	6.1	3	I	Category B SW2	
2993	ARSENICAL PESTICIDE, LIQUID, TOXIC, FLAMMABLE flashpoint not less than 23°C	6.1	3	II	Category B SW2	
2993	ARSENICAL PESTICIDE, LIQUID, TOXIC, FLAMMABLE flashpoint not less than 23°C	6.1	3	III	Category A SW2	
2994	ARSENICAL PESTICIDE, LIQUID, TOXIC	6.1		I	Category B SW2	
2994	ARSENICAL PESTICIDE, LIQUID, TOXIC	6.1		II	Category B SW2	
2994	ARSENICAL PESTICIDE, LIQUID, TOXIC	6.1		III	Category A SW2	
2995	ORGANOCHLORINE PESTICIDE, LIQUID, TOXIC, FLAMMABLE flashpoint not less than 23°C	6.1	3	I	Category B SW2	
2995	ORGANOCHLORINE PESTICIDE, LIQUID, TOXIC, FLAMMABLE flashpoint not less than 23°C	6.1	3	II	Category B SW2	
2995	ORGANOCHLORINE PESTICIDE, LIQUID, TOXIC, FLAMMABLE flashpoint not less than 23°C	6.1	3	III	Category A SW2	
2996	ORGANOCHLORINE PESTICIDE, LIQUID, TOXIC	6.1		I	Category B SW2	
2996	ORGANOCHLORINE PESTICIDE, LIQUID, TOXIC	6.1		II	Category B SW2	
2996	ORGANOCHLORINE PESTICIDE, LIQUID, TOXIC	6.1		III	Category A SW2	
2997	TRIAZINE PESTICIDE, LIQUID, TOXIC, FLAMMABLE, flashpoint not less than 23°C	6.1	3	I	Category B SW2	
2997	TRIAZINE PESTICIDE, LIQUID, TOXIC, FLAMMABLE, flashpoint not less than 23°C	6.1	3	II	Category B SW2	

UN Number	PROPER SHIPPING NAME (Note: When there is more than one packing group or PSN the UN No. has been annotated with a, b, c)	Class or division	Subsidiary risk(s)	Packing Group	Stowage and Handling	Segregation
2997	TRIAZINE PESTICIDE, LIQUID, TOXIC, FLAMMABLE, flashpoint not less than 23°C	6.1	3	III	Category A SW2	
2998	TRIAZINE PESTICIDE, LIQUID, TOXIC	6.1		I	Category B SW2	
2998	TRIAZINE PESTICIDE, LIQUID, TOXIC	6.1		II	Category B SW2	
2998	TRIAZINE PESTICIDE, LIQUID, TOXIC	6.1		III	Category A SW2	
3005	THIOCARBAMATE PESTICIDE, LIQUID, TOXIC, FLAMMABLE flashpoint not less than 23°C	6.1	3	I	Category B SW2	
3005	THIOCARBAMATE PESTICIDE, LIQUID, TOXIC, FLAMMABLE flashpoint not less than 23°C	6.1	3	II	Category B SW2	
3005	THIOCARBAMATE PESTICIDE, LIQUID, TOXIC, FLAMMABLE flashpoint not less than 23°C	6.1	3	III	Category A SW2	
3006	THIOCARBAMATE PESTICIDE, LIQUID, TOXIC	6.1		I	Category B SW2	
3006	THIOCARBAMATE PESTICIDE, LIQUID, TOXIC	6.1		II	Category B SW2	
3006	THIOCARBAMATE PESTICIDE, LIQUID, TOXIC	6.1		III	Category A SW2	
3009	COPPER BASED PESTICIDE, LIQUID, TOXIC, FLAMMABLE flashpoint not less than 23°C	6.1		I	Category B SW2	
3009	COPPER BASED PESTICIDE, LIQUID, TOXIC, FLAMMABLE flashpoint not less than 23°C	6.1	3	II	Category B SW2	
3009	COPPER BASED PESTICIDE, LIQUID, TOXIC, FLAMMABLE flashpoint not less than 23°C	6.1	3	III	Category A SW2	
3010	COPPER BASED PESTICIDE, LIQUID, TOXIC	6.1		I	Category B SW2	
3010	COPPER BASED PESTICIDE, LIQUID, TOXIC	6.1		II	Category B SW2	
3010	COPPER BASED PESTICIDE, LIQUID, TOXIC	6.1		III	Category A SW2	
3011	MERCURY BASED PESTICIDE, LIQUID, TOXIC, FLAMMABLE flashpoint not less than 23°C	6.1	3P	I	Category B SW2	
3011	MERCURY BASED PESTICIDE, LIQUID, TOXIC, FLAMMABLE flashpoint not less than 23°C	6.1	3P	II	Category B SW2	
3011	MERCURY BASED PESTICIDE, LIQUID, TOXIC, FLAMMABLE flashpoint not less than 23°C	6.1	3P	III	Category A SW2	
3012	MERCURY BASED PESTICIDE, LIQUID, TOXIC	6.1	P	I	Category B SW2	
3012	MERCURY BASED PESTICIDE, LIQUID, TOXIC	6.1	P	II	Category B SW2	
3012	MERCURY BASED PESTICIDE, LIQUID, TOXIC	6.1	P	III	Category A SW2	
3013	SUBSTITUTED NITROPHENOL PESTICIDE, LIQUID, TOXIC, FLAMMABLE flashpoint not less than 23°	6.1	3	I	Category B SW2	
3013	SUBSTITUTED NITROPHENOL PESTICIDE, LIQUID, TOXIC, FLAMMABLE flashpoint not less than 23°	6.1	3	II	Category B SW2	
3013	SUBSTITUTED NITROPHENOL PESTICIDE, LIQUID, TOXIC, FLAMMABLE flashpoint not less than 23°	6.1	3	III	Category A SW2	
3014	SUBSTITUTED NITROPHENOL PESTICIDE, LIQUID, TOXIC	6.1		I	Category B SW2	
3014	SUBSTITUTED NITROPHENOL PESTICIDE, LIQUID, TOXIC	6.1		II	Category B SW2	

UN Number	PROPER SHIPPING NAME (Note: When there is more than one packing group or PSN the UN No. has been annotated with a, b, c.)	Class or division	Subsidiary risk(s)	Packing Group	Stowage and Handling	Segregation
3014	SUBSTITUTED NITROPHENOL PESTICIDE, LIQUID, TOXIC	6.1		III	Category A SW2	
3015	BIPYRIDILIU PESTICIDE, LIQUID, TOXIC, FLAMMABLE flashpoint not less than 23°C	6.1		I	Category B SW2	
3015	BIPYRIDILIU PESTICIDE, LIQUID, TOXIC, FLAMMABLE flashpoint not less than 23°C	6.1	3	II	Category B SW2	
3015	BIPYRIDILIU PESTICIDE, LIQUID, TOXIC, FLAMMABLE flashpoint not less than 23°C	6.1	3	III	Category A SW2	
3016	BIPYRIDILIU PESTICIDE, LIQUID, TOXIC	6.1		I	Category B SW2	
3016	BIPYRIDILIU PESTICIDE, LIQUID, TOXIC	6.1		II	Category B SW2	
3016	BIPYRIDILIU PESTICIDE, LIQUID, TOXIC	6.1		III	Category A SW2	
3017	ORGANOPHOSPHORUS PESTICIDE, LIQUID, TOXIC, FLAMMABLE flashpoint not less than 23°C	6.1	3	I	Category B SW2	
3017	ORGANOPHOSPHORUS PESTICIDE, LIQUID, TOXIC, FLAMMABLE flashpoint not less than 23°C	6.1	3	II	Category B SW2	
3017	ORGANOPHOSPHORUS PESTICIDE, LIQUID, TOXIC, FLAMMABLE flashpoint not less than 23°C	6.1	3	III	Category A SW2	
3018	ORGANOPHOSPHORUS PESTICIDE, LIQUID, TOXIC	6.1		I	Category B SW2	
3018	ORGANOPHOSPHORUS PESTICIDE, LIQUID, TOXIC	6.1		II	Category B SW2	
3018	ORGANOPHOSPHORUS PESTICIDE, LIQUID, TOXIC	6.1		III	Category A SW2	
3019	ORGANOTIN PESTICIDE, LIQUID, TOXIC, FLAMMABLE flashpoint not less than 23°C	6.1	3P	I	Category B SW2	
3019	ORGANOTIN PESTICIDE, LIQUID, TOXIC, FLAMMABLE flashpoint not less than 23°C	6.1	3P	II	Category B SW2	
3019	ORGANOTIN PESTICIDE, LIQUID, TOXIC, FLAMMABLE flashpoint not less than 23°C	6.1	3P	III	Category A SW2	
3020	ORGANOTIN PESTICIDE, LIQUID, TOXIC	6.1	P	I	Category B SW2	
3020	ORGANOTIN PESTICIDE, LIQUID, TOXIC	6.1	P	II	Category B SW2	
3020	ORGANOTIN PESTICIDE, LIQUID, TOXIC	6.1	P	III	Category A SW2	
3021	PESTICIDE, LIQUID, FLAMMABLE, TOXIC, N.O.S. flashpoint less than 23°C	3	6.1	I	Category B SW2	
3021	PESTICIDE, LIQUID, FLAMMABLE, TOXIC, N.O.S. flashpoint less than 23°C	3	6.1	II	Category B SW2	
3022	1,2-BUTYLENE OXIDE, STABILIZED	3		II	Category B	SG20 SG21
3023	2-METHYL-2-HEPTANETHIOL	6.1	3	I	Category D SW2	SG57
3024	COUMARIN DERIVATIVE PESTICIDE, LIQUID, FLAMMABLE, TOXIC, flashpoint less than 23°C	3	6.1	I	Category B SW2	
3024	COUMARIN DERIVATIVE PESTICIDE, LIQUID, FLAMMABLE, TOXIC, flashpoint less than 23°C	3	6.1	II	Category B SW2	
3025	COUMARIN DERIVATIVE PESTICIDE, LIQUID, TOXIC, FLAMMABLE flashpoint not less than 23°C	6.1	3	I	Category B SW2	

UN Number	PROPER SHIPPING NAME (Note: When there is more than one packing group or PSN the UN No. has been annotated with a, b, c.)	Class or division	Subsidiary risk(s)	Packing Group	Stowage and Handling	Segregation
3025	COUMARIN DERIVATIVE PESTICIDE, LIQUID, TOXIC, FLAMMABLE flashpoint not less than 23°C	6.1	3	II	Category B SW2	
3025	COUMARIN DERIVATIVE PESTICIDE, LIQUID, TOXIC, FLAMMABLE flashpoint not less than 23°C	6.1	3	III	Category A SW2	
3026	COUMARIN DERIVATIVE PESTICIDE, LIQUID, TOXIC	6.1		I	Category B SW2	
3026	COUMARIN DERIVATIVE PESTICIDE, LIQUID, TOXIC	6.1		II	Category B SW2	
3026	COUMARIN DERIVATIVE PESTICIDE, LIQUID, TOXIC	6.1		III	Category A SW2	
3027	COUMARIN DERIVATIVE PESTICIDE, SOLID, TOXIC	6.1		I	Category A SW2	
3027	COUMARIN DERIVATIVE PESTICIDE, SOLID, TOXIC	6.1		II	Category A SW2	
3027	COUMARIN DERIVATIVE PESTICIDE, SOLID, TOXIC	6.1		III	Category A SW2	
3028	BATTERIES, DRY, CONTAINING POTASSIUM HYDROXIDE, SOLID electric storage	8		III	Category A	SG35
3048	ALUMINIUM PHOSPHIDE PESTICIDE	6.1		I	Category E SW2 SW5	
3054	CYCLOHEXANETHIOL (CYCLOHEXYL MERCAPTAN)	3		III	Category A SW2	SG50 SG57
3055	2-(2-AMINOETHOXY) ETHANOL	8	8	III	Category A	
3056	n-HEPTALDEHYDE	3		III	Category A	
3057	TRIFLUOROACETYL CHLORIDE	2.3	8		Category D SW2	
3064	NITROGLYCERIN SOLUTION IN ALCOHOL with more than 1% but not more than 5% nitroglycerin	3		II	Category E	
3065	ALCOHOLIC BEVERAGES, with more than 70% alcohol by volume	3		II	Category A	
3065	ALCOHOLIC BEVERAGES, with more than 24% but not more than 70% alcohol by volume	3		III	Category A	
3066	PAINT (including paint, lacquer, enamel, stain, shellac, varnish, polish, liquid filler)	8		II	Category B SW2	
3066	PAINT (including paint, lacquer, enamel, stain, shellac, varnish, polish, liquid filler)	8		III	Category A SW2	
3070	ETHYLENE OXIDE AND DICHLORODIFLUOROMETHANE MIXTURE with not more than 12.5% ethylene oxi	2.2			Category A	
3071	MERCAPTANS, LIQUID, TOXIC, FLAMMABLE, N.O.S. or MERCAPTAN MIXTURE, LIQUID, TOXIC, FLAMMA	6.1	3	II	Category C SW2	SG57
3072	LIFE-SAVING APPLIANCES, NOT SELF-INFLATING containing dangerous goods as equipment	9			Category A	SG18 SG71
3073	VINYLPYRIDINES, STABILIZED	6.1	3/8	II	Category C SW2	SG5 SG8 SG35
3077	ENVIRONMENTALLY HAZARDOUS SUBSTANCE, SOLID, N.O.S.	9		III	Category A SW23	
3078	CERIUM turnings or gritty powder	4.3		II	Category E	SG35
3079	METHACRYLONITRILE, STABILIZED	6.1	3	I	Category D SW2	



UN Number	PROPER SHIPPING NAME (Note: When there is more than one packing group or PSN the UN No. has been annotated with a, b, c.)	Class or division	Subsidiary risk(s)	Packing Group	Stowage and Handling	Segregation
3080	ISOCYANATES, TOXIC, FLAMMABLE, N.O.S or ISOCYANATE SOLUTION, TOXIC, FLAMMABLE, N.O.S.	6.1	3	II	Category D SW1 SW2	
3082	ENVIRONMENTALLY HAZARDOUS SUBSTANCE, LIQUID, N.O.S.	9		III	Category A	
3083	PERCHLORYL FLUORIDE	2.3	5.1		Category D SW2	
3084	CORROSIVE SOLID, OXIDIZING, N.O.S.	8	5.1	I	Category C	
3084	CORROSIVE SOLID, OXIDIZING, N.O.S.	8	5.1	II	Category C	
3085	OXIDIZING SOLID, CORROSIVE, N.O.S.	5.1	8	I	Category D H1	SG38 SG49 SG60
3085	OXIDIZING SOLID, CORROSIVE, N.O.S.	5.1	8	II	Category B H1	SG38 SG49 SG60
3085	OXIDIZING SOLID, CORROSIVE, N.O.S.	5.1	8	III	Category B H1	SG38 SG49 SG60
3086	TOXIC SOLID, OXIDIZING, N.O.S.	6.1	5.1	I	Category C	
3086	TOXIC SOLID, OXIDIZING, N.O.S.	6.1	5.1	II	Category C	
3087	OXIDIZING SOLID, TOXIC, N.O.S.	5.1	5.1	I	Category D	SG38 SG49 SG60
3087	OXIDIZING SOLID, TOXIC, N.O.S.	5.1	6.1	II	Category B	SG38 SG49 SG60
3087	OXIDIZING SOLID, TOXIC, N.O.S.	5.1	6.1	III	Category B	SG38 SG49 SG60
3088	SELF-HEATING SOLID, ORGANIC, N.O.S.	4.2		II	Category C	
3088	SELF-HEATING SOLID, ORGANIC, N.O.S.	4.2		III	Category C	
3089	METAL POWDER, FLAMMABLE, N.O.S.	4.1		II	Category B	SG17
3089	METAL POWDER, FLAMMABLE, N.O.S.	4.1		III	Category B	SG17
3090	LITHIUM METAL BATTERIES (including lithium alloy batteries)	9		II	Category A	
3091	LITHIUM METAL BATTERIES CONTAINED IN EQUIPMENT or LITHIUM METAL BATTERIES PACKED WITH EQUIPMENT (including lithium alloy batteries)	9		II	Category A	
3092	1-METHOXY-2-PROPANOL	3		III	Category A	
3093	CORROSIVE LIQUID, OXIDIZING, N.O.S.	8	5.1	I	Category C	
3093	CORROSIVE LIQUID, OXIDIZING, N.O.S.	8	5.1	II	Category C	
3094	CORROSIVE LIQUID, WATER-REACTIVE, N.O.S.	8	4.3	I	Category D	
3094	CORROSIVE LIQUID, WATER-REACTIVE, N.O.S.	8	4.3	II	Category D	
3095	CORROSIVE SOLID, SELF-HEATING, N.O.S.	8	4.2	I	Category D	
3095	CORROSIVE SOLID, SELF-HEATING, N.O.S.	8	4.2	II	Category D	
3096	CORROSIVE SOLID, WATER-REACTIVE, N.O.S.	8	4.3	I	Category D	
3096	CORROSIVE SOLID, WATER-REACTIVE, N.O.S.	8	4.3	II	Category D	
3097	FLAMMABLE SOLID, OXIDIZING, N.O.S.	4.1	5.1	II	-	
3097	FLAMMABLE SOLID, OXIDIZING, N.O.S.	4.1	5.1	III	-	
3098	OXIDIZING LIQUID, CORROSIVE, N.O.S.	5.1	8	I	Category D H1	SG38 SG49 SG60

UN Number	PROPER SHIPPING NAME (Note: When there is more than one packing group or PSN the UN No. has been annotated with a, b, c)	Class or division	Subsidiary risk(s)	Packing Group	Stowage and Handling	Segregation
3098	OXIDIZING LIQUID, CORROSIVE, N.O.S.	5.1	8	II	Category B H1	SG38 SG49 SG60
3098	OXIDIZING LIQUID, CORROSIVE, N.O.S.	5.1	8	III	Category B H1	SG38 SG49 SG60
3099	OXIDIZING LIQUID, TOXIC, N.O.S.	5.1	6.1	I	Category D	SG38 SG49 SG60
3099	OXIDIZING LIQUID, TOXIC, N.O.S.	5.1	6.1	II	Category B	SG38 SG49 SG60
3099	OXIDIZING LIQUID, TOXIC, N.O.S.	5.1	6.1	III	Category B	SG38 SG49 SG60
3100	OXIDIZING SOLID, SELF-HEATING, N.O.S.	5.1	4.2	I	-	
3100	OXIDIZING SOLID, SELF-HEATING, N.O.S.	5.1	4.2	II	-	
3101	ORGANIC PEROXIDE TYPE B, LIQUID	5.2	See SP181		Category D SW1	SG1 SG35 SG36
3102	ORGANIC PEROXIDE TYPE B, SOLID	5.2	See SP181		Category D SW1	SG1 SG35 SG36
3103	ORGANIC PEROXIDE TYPE C, LIQUID	5.2			Category D SW1	SG35 SG36
3104	ORGANIC PEROXIDE TYPE C, SOLID	5.2			Category D SW1	SG35 SG36
3105	ORGANIC PEROXIDE TYPE D, LIQUID	5.2			Category D SW1	SG35 SG36 SG72
3106	ORGANIC PEROXIDE TYPE D, SOLID	5.2			Category D SW1	SG35 SG36
3107	ORGANIC PEROXIDE TYPE E, LIQUID	5.2			Category D SW1	SG35 SG36 SG72
3108	ORGANIC PEROXIDE TYPE E, SOLID	5.2			Category D SW1	SG35 SG36
3109	ORGANIC PEROXIDE TYPE F, LIQUID	5.2			Category D SW1	SG35 SG36 SG72
3110	ORGANIC PEROXIDE TYPE F, SOLID	5.2			Category D SW1	SG35 SG36
3111	ORGANIC PEROXIDE TYPE B, LIQUID, TEMPERATURE CONTROLLED	5.2			Category D SW1 SW3	SG1 SG35 SG36
3112	ORGANIC PEROXIDE TYPE B, SOLID, TEMPERATURE CONTROLLED	5.2	See SP181		Category D SW1 SW3	SG1 SG35 SG36
3113	ORGANIC PEROXIDE TYPE C, LIQUID, TEMPERATURE CONTROLLED	5.2			Category D SW1 SW3	SG35 SG36
3114	ORGANIC PEROXIDE TYPE C, SOLID, TEMPERATURE CONTROLLED	5.2			Category D SW1 SW3	SG35 SG36
3115	ORGANIC PEROXIDE TYPE D, LIQUID, TEMPERATURE CONTROLLED	5.2			Category D SW1 SW3	SG35 SG36
3116	ORGANIC PEROXIDE TYPE D, SOLID, TEMPERATURE CONTROLLED	5.2			Category D SW1 SW3	SG35 SG36
3117	ORGANIC PEROXIDE TYPE E, LIQUID, TEMPERATURE CONTROLLED	5.2			Category D SW1 SW3	SG35 SG36
3118	ORGANIC PEROXIDE TYPE E, SOLID, TEMPERATURE CONTROLLED	5.2			Category D SW1 SW3	SG35 SG36

UN Number	PROPER SHIPPING NAME (Note: When there is more than one packing group or PSN the UN No. has been annotated with a, b, c)	Class or division	Subsidiary risk(s)	Packing Group	Stowage and Handling	Segregation
3119	ORGANIC PEROXIDE TYPE F, LIQUID, TEMPERATURE CONTROLLED	5.2			Category D SW1 SW3	SG35 SG36
3120	ORGANIC PEROXIDE TYPE F, SOLID, TEMPERATURE CONTROLLED	5.2			Category D SW1 SW3	SG35 SG36
3121	OXIDIZING SOLID, WATER-REACTIVE, N.O.S.	5.1	4.3	I	-	
3121	OXIDIZING SOLID, WATER-REACTIVE, N.O.S.	5.1	4.3	II	-	
3122	TOXIC LIQUID, OXIDIZING, N.O.S.	6.1	5.1	I	Category C	
3122	TOXIC LIQUID, OXIDIZING, N.O.S.	6.1	5.1	II	Category C	
3123	TOXIC LIQUID, WATER-REACTIVE, N.O.S.	6.1	4.3	I	Category D SW2	
3123	TOXIC LIQUID, WATER-REACTIVE, N.O.S.	6.1	4.3	II	Category D SW2	
3124	TOXIC SOLID, SELF-HEATING, N.O.S.	6.1	4.2	I	Category D SW2	
3124	TOXIC SOLID, SELF-HEATING, N.O.S.	6.1	4.2	II	Category D SW2	
3125	TOXIC SOLID, WATER-REACTIVE, N.O.S.	6.1	4.3	I	Category D SW2	
3125	TOXIC SOLID, WATER-REACTIVE, N.O.S.	6.1	4.3	II	Category D SW2	
3126	SELF-HEATING SOLID, CORROSIVE, ORGANIC, N.O.S.	4.2	8	II	Category C	
3126	SELF-HEATING SOLID, CORROSIVE, ORGANIC, N.O.S.	4.2	8	III	Category C	
3127	SELF-HEATING SOLID, OXIDIZING, N.O.S.	4.2	5.1	II	-	
3127	SELF-HEATING SOLID, OXIDIZING, N.O.S.	4.2	5.1	III	-	
3128	SELF-HEATING SOLID, TOXIC, ORGANIC, N.O.S.	4.2	6.1	II	Category C	
3128	SELF-HEATING SOLID, TOXIC, ORGANIC, N.O.S.	4.2	6.1	III	Category C	
3129	WATER-REACTIVE LIQUID, CORROSIVE, N.O.S.	4.3	8	I	Category D	
3129	WATER-REACTIVE LIQUID, CORROSIVE, N.O.S.	4.3	8	II	Category E SW5	
3129	WATER-REACTIVE LIQUID, CORROSIVE, N.O.S.	4.3	8	III	Category E	
3130	WATER-REACTIVE LIQUID, TOXIC, N.O.S.	4.3	6.1	I	Category D	
3130	WATER-REACTIVE LIQUID, TOXIC, N.O.S.	4.3	6.1	II	Category E SW5	
3130	WATER-REACTIVE LIQUID, TOXIC, N.O.S.	4.3	6.1	III	Category E SW5	
3131	WATER-REACTIVE SOLID, CORROSIVE, N.O.S.	4.3	8	I	Category D	
3131	WATER-REACTIVE SOLID, CORROSIVE, N.O.S.	4.3	8	II	Category E SW5	
3131	WATER-REACTIVE SOLID, CORROSIVE, N.O.S.	4.3	8	III	Category E SW5	
3132	WATER-REACTIVE SOLID, FLAMMABLE, N.O.S.	4.3	4.1	I	-	
3132	WATER-REACTIVE SOLID, FLAMMABLE, N.O.S.	4.3	4.1	II	-	
3132	WATER-REACTIVE SOLID, FLAMMABLE, N.O.S.	4.3	5.1	III	-	
3133	WATER-REACTIVE SOLID, OXIDIZING, N.O.S.	4.3	5.1	II	-	
3133	WATER-REACTIVE SOLID, OXIDIZING, N.O.S.	4.3	5.1	III	-	
3134	WATER-REACTIVE SOLID, TOXIC, N.O.S.	4.3	6.1	I	Category D	
3134	WATER-REACTIVE SOLID, TOXIC, N.O.S.	4.3	6.1	II	Category E SW5	

UN Number	PROPER SHIPPING NAME (Note: When there is more than one packing group or PSN the UN No. has been annotated with a, b, c)	Class or division	Subsidiary risk(s)	Packing Group	Stowage and Handling	Segregation
3134	WATER-REACTIVE SOLID, TOXIC, N.O.S.	4.3	6.1	III	Category E SW5	
3135	WATER-REACTIVE SOLID, SELF-HEATING, N.O.S.	4.3	4.2	I	-	
3135	WATER-REACTIVE SOLID, SELF-HEATING, N.O.S.	4.3	4.2	II	-	
3135	WATER-REACTIVE SOLID, SELF-HEATING, N.O.S.	4.3	4.2	III	-	
3136	TRIFLUOROMETHANE, REFRIGERATED LIQUID	2.2			Category D	
3137	OXIDIZING SOLID, FLAMMABLE, N.O.S.	5.1	4.1	I	-	
3138	ETHYLENE, ACETYLENE AND PROPYLENE MIXTURE, REFRIGERATED LIQUID containing at least 71.5% ethylene, with not more than 22.5% acetylene and not more than 6% propylene	2.1			Category D SW2	SG46
3139	OXIDIZING LIQUID, N.O.S.	5.1		I	Category D	SG38 SG49 SG60
3139	OXIDIZING LIQUID, N.O.S.	5.1		II	Category B	SG38 SG49 SG60
3139	OXIDIZING LIQUID, N.O.S.	5.1		III	Category B	SG38 SG49 SG60
3140	ALKALOIDS, LIQUID, N.O.S. or ALKALOIDS SALTS, LIQUID, N.O.S.	6.1		I	Category A	
3140	ALKALOIDS, LIQUID, N.O.S. or ALKALOIDS SALTS, LIQUID, N.O.S.	6.1		II	Category A	
3140	ALKALOIDS, LIQUID, N.O.S. or ALKALOIDS SALTS, LIQUID, N.O.S.	6.1		III	Category A	
3141	ANTIMONY COMPOUND, INORGANIC, LIQUID, N.O.S.	6.1		III	Category A	
3142	DISINFECTANT, LIQUID, TOXIC, N.O.S.	6.1		I	Category A SW2	
3142	DISINFECTANT, LIQUID, TOXIC, N.O.S.	6.1		II	Category A SW2	
3142	DISINFECTANT, LIQUID, TOXIC, N.O.S.	6.1		III	Category A SW2	
3143	DYE, SOLID, TOXIC, N.O.S. or DYE INTERMEDIATE, SOLID, TOXIC, N.O.S.	6.1		I	Category A	
3143	DYE, SOLID, TOXIC, N.O.S. or DYE INTERMEDIATE, SOLID, TOXIC, N.O.S.	6.1		II	Category A	
3143	DYE, SOLID, TOXIC, N.O.S. or DYE INTERMEDIATE, SOLID, TOXIC, N.O.S.	6.1		III	Category A	
3144	NICOTINE COMPOUND, LIQUID, N.O.S. or NICOTINE PREPARATION, LIQUID, N.O.S.	6.1		I	Category B SW2	
3144	NICOTINE COMPOUND, LIQUID, N.O.S. or NICOTINE PREPARATION, LIQUID, N.O.S.	6.1		II	Category B SW2	
3144	NICOTINE COMPOUND, LIQUID, N.O.S. or NICOTINE PREPARATION, LIQUID, N.O.S.	6.1		III	Category B SW2	
3145	ALKYLPHENOLS, LIQUID, N.O.S. (including C2-C12 homologues)	8		I	Category B	
3145	ALKYLPHENOLS, LIQUID, N.O.S. (including C2-C12 homologues)	8		II	Category B	
3145	ALKYLPHENOLS, LIQUID, N.O.S. (including C2-C12 homologues)	8		III	Category A	
3146	ORGANOTIN COMPOUND, SOLID, N.O.S.	6.1	P	I	Category B SW2	
3146	ORGANOTIN COMPOUND, SOLID, N.O.S.	6.1	P	II	Category A SW2	

UN Number	PROPER SHIPPING NAME (Note: When there is more than one packing group or PSN the UN No. has been annotated with a, b, c)	Class or division	Subsidiary risk(s)	Packing Group	Stowage and Handling	Segregation
3146	ORGANOTIN COMPOUND, SOLID, N.O.S.	6.1	P	III	Category A SW2	
3147	DYE, SOLID, CORROSIVE, N.O.S. or DYE INTERMEDIATE, SOLID, CORROSIVE, N.O.S.	8		I	Category A	
3147	DYE, SOLID, CORROSIVE, N.O.S. or DYE INTERMEDIATE, SOLID, CORROSIVE, N.O.S.	8		II	Category A	
3147	DYE, SOLID, CORROSIVE, N.O.S. or DYE INTERMEDIATE, SOLID, CORROSIVE, N.O.S.	8		III	Category A	
3148	WATER-REACTIVE LIQUID, N.O.S.	4.3		I	Category E SW2	
3148	WATER-REACTIVE LIQUID, N.O.S.	4.3		II	Category E SW2	
3148	WATER-REACTIVE LIQUID, N.O.S.	4.3		III	Category E SW2	
3149	HYDROGEN PEROXIDE AND PEROXYACETIC ACID MIXTURE, with acid(s), water and not more than 5	5.1	8	II	Category D SW1	SG16 SG59 SG72
3150	DEVICES, SMALL, HYDROCARBON GAS POWERED or HYDROCARBON GAS REFILLS FOR SMALL DEVICES wi	2.1			Category B SW2	
3151	POLYHALOGENATED BIPHENYLS, LIQUID or POLYHALOGENATED TERPHENYLS, LIQUID	9		II	Category A	SG50
3152	POLYHALOGENATED BIPHENYLS, SOLID or POLYHALOGENATED TERPHENYLS, SOLID	9	P	II	Category A	SG50
3153	PERFLUORO (METHYL VINYL ETHER)	2.1			Category E SW2	
3154	PERFLUORO (ETHYL VINYL ETHER)	2.1			Category E SW2	
3155	PENTACHLOROPHENOL	6.1	P	II	Category A	
3156	COMPRESSED GAS, OXIDIZING, N.O.S.	2.2	5.1		Category D	
3157	LIQUEFIED GAS, OXIDIZING, N.O.S.	2.2	5.1		Category D	
3158	GAS, REFRIGERATED LIQUID, N.O.S.	2.2			Category D	
3159	1,1,1,2-TETRAFLUOROETHANE (REFRIGERANT GAS R 134a)	2.2			Category A	
3160	LIQUEFIED GAS, TOXIC, FLAMMABLE, N.O.S.	2.3	2.1		Category D SW2	
3161	LIQUEFIED GAS, FLAMMABLE, N.O.S.	2.1			Category D SW2	
3162	LIQUEFIED GAS, TOXIC, N.O.S.	2.3			Category D SW2	
3163	LIQUEFIED GAS, N.O.S.	2.2			Category A	
3164	ARTICLES, PRESSURIZED, PNEUMATIC or HYDRAULIC (containing non-flammable gas)	2.2			Category A	
3165	AIRCRAFT HYDRAULIC POWER UNIT FUEL TANK (containing a mixture of anhydrous hydrazine and	3	*6.1/8	I	Category D SW2	SG5 SG8 SG13
3166	ENGINE, INTERNAL COMBUSTION or VEHICLE, FLAMMABLE GAS POWERED or VEHICLE, FLAMMABLE LIQU	9			Category A	
3167	GAS SAMPLE, NON-PRESSURIZED, FLAMMABLE, N.O.S., not refrigerated liquid	2.1			Category D	
3168	GAS SAMPLE, NON-PRESSURIZED, TOXIC, FLAMMABLE, N.O.S., not refrigerated liquid	2.3	2.1		Category D	

UN Number	PROPER SHIPPING NAME (Note: When there is more than one packing group or PSN the UN No. has been annotated with a, b, c)	Class or division	Subsidiary risk(s)	Packing Group	Stowage and Handling	Segregation
3169	GAS SAMPLE, NON-PRESSURIZED, TOXIC, N.O.S., not refrigerated liquid	2.3			Category D	
3170	ALUMINIUM SMELTING BY-PRODUCTS or ALUMINIUM REMELTING BY-PRODUCTS	4.3		II	Category B SW5 H1	
3170	ALUMINIUM SMELTING BY-PRODUCTS or ALUMINIUM REMELTING BY-PRODUCTS	4.3		III	Category B SW5 H1	
3171	BATTERY-POWERED VEHICLE or BATTERY-POWERED EQUIPMENT	9			Category A	
3172	TOXINS, EXTRACTED FROM LIVING SOURCES, LIQUID, N.O.S.	6.1		I	Category B	
3172	TOXINS, EXTRACTED FROM LIVING SOURCES, LIQUID, N.O.S.	6.1		II	Category B	
3172	TOXINS, EXTRACTED FROM LIVING SOURCES, LIQUID, N.O.S.	6.1		III	Category A	
3174	TITANIUM DISULPHIDE	4.2		III	Category A	
3175	SOLIDS CONTAINING FLAMMABLE LIQUID, N.O.S.	4.1		II	Category B	
3176	FLAMMABLE SOLID, ORGANIC, MOLTEN, N.O.S.	4.1		II	Category C	
3176	FLAMMABLE SOLID, ORGANIC, MOLTEN, N.O.S.	4.1		III	Category C	
3178	FLAMMABLE SOLID, INORGANIC, N.O.S.	4.1		II	Category B	
3178	FLAMMABLE SOLID, INORGANIC, N.O.S.	4.1		III	Category B	
3179	FLAMMABLE SOLID, TOXIC, INORGANIC, N.O.S.	4.1	6.1	II	Category B SW2	
3179	FLAMMABLE SOLID, TOXIC, INORGANIC, N.O.S.	4.1	6.1	III	Category B SW2	
3180	FLAMMABLE SOLID, CORROSIVE, INORGANIC, N.O.S.	4.1	8	II	Category D SW2	
3180	FLAMMABLE SOLID, CORROSIVE, INORGANIC, N.O.S.	4.1	8	III	Category D SW2	
3181	METAL SALTS OF ORGANIC COMPOUNDS, FLAMMABLE, N.O.S.	4.1		II	Category B SW2	
3181	METAL SALTS OF ORGANIC COMPOUNDS, FLAMMABLE, N.O.S.	4.1		III	Category B SW2	
3182	METAL HYDRIDES, FLAMMABLE, N.O.S.	4.1		II	Category E	
3182	METAL HYDRIDES, FLAMMABLE, N.O.S.	4.1		III	Category E	
3183	SELF-HEATING LIQUID, ORGANIC, N.O.S.	4.2		II	Category C	
3183	SELF-HEATING LIQUID, ORGANIC, N.O.S.	4.2		III	Category C	
3184	SELF-HEATING LIQUID, TOXIC, ORGANIC, N.O.S.	4.2	6.1	II	Category C	
3184	SELF-HEATING LIQUID, TOXIC, ORGANIC, N.O.S.	4.2	6.1	III	Category C	
3185	SELF-HEATING LIQUID, CORROSIVE, ORGANIC, N.O.S.	4.2	8	II	Category C	
3185	SELF-HEATING LIQUID, CORROSIVE, ORGANIC, N.O.S.	4.2	8	III	Category C	
3186	SELF-HEATING LIQUID, INORGANIC, N.O.S.	4.2		II	Category C	
3186	SELF-HEATING LIQUID, INORGANIC, N.O.S.	4.2		III	Category C	
3187	SELF-HEATING LIQUID, TOXIC, INORGANIC, N.O.S.	4.2	6.1	II	Category C	
3187	SELF-HEATING LIQUID, TOXIC, INORGANIC, N.O.S.	4.2	6.1	III	Category C	
3188	SELF-HEATING LIQUID, CORROSIVE, INORGANIC, N.O.S.	4.2	8	II	Category C	
3188	SELF-HEATING LIQUID, CORROSIVE, INORGANIC, N.O.S.	4.2	8	III	Category C	
3189	METAL POWDER, SELF-HEATING, N.O.S.	4.2		II	Category C	

UN Number	PROPER SHIPPING NAME (Note: When there is more than one packing group or PSN the UN No. has been annotated with a, b, c.)	Class or division	Subsidiary risk(s)	Packing Group	Stowage and Handling	Segregation
3189	METAL POWDER, SELF-HEATING, N.O.S.	4.2		III	Category C	
3190	SELF-HEATING SOLID, INORGANIC, N.O.S.	4.2		II	Category C	
3190	SELF-HEATING SOLID, INORGANIC, N.O.S.	4.2		III	Category C	
3191	SELF-HEATING SOLID, TOXIC, INORGANIC, N.O.S.	4.2	6.1	II	Category C	
3191	SELF-HEATING SOLID, TOXIC, INORGANIC, N.O.S.	4.2	6.1	III	Category C	
3192	SELF-HEATING SOLID, CORROSIVE, INORGANIC, N.O.S.	4.2	8	II	Category C	
3192	SELF-HEATING SOLID, CORROSIVE, INORGANIC, N.O.S.	4.2	8	III	Category C	
3194	PYROPHORIC LIQUID, INORGANIC, N.O.S.	4.2		I	Category D	SG63
3200	PYROPHORIC SOLID, INORGANIC, N.O.S.	4.2		I	Category D	
3205	ALKALINE EARTH METAL ALCOHOLATES, N.O.S.	4.2		II	Category B	
3205	ALKALINE EARTH METAL ALCOHOLATES, N.O.S.	4.2		III	Category B	
3206	ALKALI METAL ALCOHOLATES, SELF-HEATING, CORROSIVE, N.O.S.	4.2	8	II	Category B	
3206	ALKALI METAL ALCOHOLATES, SELF-HEATING, CORROSIVE, N.O.S.	4.2	8	III	Category B	
3208	METALLIC SUBSTANCE, WATER REACTIVE, N.O.S.	4.3		I	Category E SW2	
3208	METALLIC SUBSTANCE, WATER REACTIVE, N.O.S.	4.3		II	Category E SW2	
3208	METALLIC SUBSTANCE, WATER REACTIVE, N.O.S.	4.3		III	Category E SW2	
3209	METALLIC SUBSTANCE, WATER REACTIVE, SELF-HEATING, N.O.S.	4.3	4.2	I	Category E SW2	
3209	METALLIC SUBSTANCE, WATER REACTIVE, SELF-HEATING, N.O.S.	4.3	4.2	II	Category E SW2	
3209	METALLIC SUBSTANCE, WATER REACTIVE, SELF-HEATING, N.O.S.	4.3	4.2	III	Category E SW2	
3210	CHLORATES, INORGANIC, AQUEOUS SOLUTION, N.O.S.	5.1		II	Category B	SG38 SG49 SG62
3210	CHLORATES, INORGANIC, AQUEOUS SOLUTION, N.O.S.	5.1		III	Category B	SG38 SG49 SG62
3211	PERCHLORATES, INORGANIC, AQUEOUS SOLUTION, N.O.S.	5.1		II	Category B	SG38 SG49 SG62
3211	PERCHLORATES, INORGANIC, AQUEOUS SOLUTION, N.O.S.	5.1		III	Category B	SG38 SG49 SG62
3212	HYPOCHLORITES, INORGANIC, N.O.S.	5.1		II	Category D SW1 SW17	SG35 SG38 SG49 SG53 SG60
3213	BROMATES, INORGANIC, AQUEOUS SOLUTION, N.O.S.	5.1		II	Category B	SG38 SG49 SG62
3213	BROMATES, INORGANIC, AQUEOUS SOLUTION, N.O.S.	5.1		III	Category B	SG38 SG49 SG62
3214	PERMANGANATES, INORGANIC, AQUEOUS SOLUTION, N.O.S.	5.1		II	Category D	SG38 SG49 SG60 SG62

UN Number	PROPER SHIPPING NAME (Note: When there is more than one packing group or PSN the UN No. has been annotated with a, b, c)	Class or division	Subsidiary risk(s)	Packing Group	Stowage and Handling	Segregation
3215	PERSULPHATES, INORGANIC, N.O.S.	5.1		III	Category A	SG40 SG49
3216	PERSULPHATES, INORGANIC, AQUEOUS SOLUTION, N.O.S.	5.1		III	Category A	SG38 SG49 SG62
3218	NITRATES, INORGANIC, AQUEOUS SOLUTION, N.O.S.	5.1		II	Category B	SG38 SG49 SG62
3218	NITRATES, INORGANIC, AQUEOUS SOLUTION, N.O.S.	5.1		III	Category B	SG38 SG49 SG62
3219	NITRITES, INORGANIC, AQUEOUS SOLUTION, N.O.S.	5.1		II	Category B	SG38 SG49 SG62
3219	NITRITES, INORGANIC, AQUEOUS SOLUTION, N.O.S.	5.1		III	Category B	SG38 SG49 SG62
3220	PENTAFLUROETHANE (REFRIGERANT GAS R 125)	2.2			Category A	
3221	SELF-REACTIVE LIQUID TYPE B	4.1	See SP181		Category D SW1	SG1 SG35 SG36
3222	SELF-REACTIVE SOLID TYPE B	4.1	See SP181		Category D SW1	SG1 SG35 SG36
3223	SELF-REACTIVE LIQUID TYPE C	4.1			Category D SW1	SG35 SG36
3224	SELF-REACTIVE SOLID TYPE C	4.1			Category D SW1	SG35 SG36
3225	SELF-REACTIVE LIQUID TYPE D	4.1			Category D SW1	SG35 SG36
3226	SELF-REACTIVE SOLID TYPE D	4.1			Category D SW1	SG35 SG36
3227	SELF-REACTIVE LIQUID TYPE E	4.1			Category D SW1	SG35 SG36
3228	SELF-REACTIVE SOLID TYPE E	4.1			Category D SW1	SG35 SG36
3229	SELF-REACTIVE LIQUID TYPE F	4.1			Category D SW1	SG35 SG36
3230	SELF-REACTIVE SOLID TYPE F	4.1			Category D SW1	SG35 SG36
3231	SELF-REACTIVE LIQUID TYPE B, TEMPERATURE CONTROLLED	4.1			Category D SW1 SW3	SG1 SG35 SG36
3232	SELF-REACTIVE SOLID TYPE B, TEMPERATURE CONTROLLED	4.1			Category D SW1 SW3	SG1 SG35 SG36
3233	SELF-REACTIVE LIQUID TYPE C, TEMPERATURE CONTROLLED	4.1			Category D SW1 SW3	SG35 SG36
3234	SELF-REACTIVE SOLID TYPE C, TEMPERATURE CONTROLLED	4.1			Category D SW1 SW3	SG35 SG36
3235	SELF-REACTIVE LIQUID TYPE D, TEMPERATURE CONTROLLED	4.1			Category D SW1 SW3	SG35 SG36
3236	SELF-REACTIVE SOLID TYPE D, TEMPERATURE CONTROLLED	4.1			Category D SW1 SW3	SG35 SG36
3237	SELF-REACTIVE LIQUID TYPE E, TEMPERATURE CONTROLLED	4.1			Category D SW1 SW3	SG35 SG36
3238	SELF-REACTIVE SOLID TYPE E, TEMPERATURE CONTROLLED	4.1			Category D SW1 SW3	SG35 SG36



UN Number	PROPER SHIPPING NAME (Note: When there is more than one packing group or PSN the UN No. has been annotated with a, b, c)	Class or division	Subsidiary risk(s)	Packing Group	Stowage and Handling	Segregation
3239	SELF-REACTIVE LIQUID TYPE F, TEMPERATURE CONTROLLED	4.1			Category D SW1 SW3	SG35 SG36
3240	SELF-REACTIVE SOLID TYPE F, TEMPERATURE CONTROLLED	4.1			Category D SW1 SW3	SG35 SG36
3241	2-BROMO-2-NITROPROPANE-1,3-DIOL	4.1		III	Category C SW1 SW2 H2 H3	
3242	AZODICARBONAMIDE	4.1		II	Category D	SG17 SG35 SG36
3243	SOLIDS CONTAINING TOXIC LIQUID, N.O.S.	6.1		II	Category B SW2	
3244	SOLIDS CONTAINING CORROSIVE LIQUID, N.O.S.	8		II	Category B SW2	
3245	GENETICALLY MODIFIED MICROORGANISMS or GENETICALLY MODIFIED ORGANISMS	9			SW7	SG50
3246	METHANESULPHONYL CHLORIDE	6.1	8	I	Category D SW2	
3247	SODIUM PEROXOBORATE, ANHYDROUS	5.1		II	Category A SW1 H1	
3248	MEDICINE, LIQUID, FLAMMABLE, TOXIC, N.O.S	3	6.1	II	Category B SW2	
3248	MEDICINE, LIQUID, FLAMMABLE, TOXIC, N.O.S	3	6.1	III	Category A	
3249	MEDICINE, SOLID, TOXIC, N.O.S.	6.1		II	Category C SW2	
3249	MEDICINE, SOLID, TOXIC, N.O.S.	6.1		III	Category C SW2	
3250	CHLOROACETIC ACID, MOLTEN	6.1	8	II	Category C SW2	
3251	ISOSORBIDE-5-MONONITRATE	4.1		III	Category D SW1 H2 H3	
3252	DIFLUOROMETHANE (REFRIGERANT GAS R 32)	2.1			Category D SW2	
3253	DISODIUM TRIOXOSILICATE	8		III	Category A	SG35
3254	TRIBUTYLPHOSPHANE	4.2		I	Category D	SG44
3255	tert-BUTYL HYPOCHLORITE	4.2	8	I	Category D	
3256	ELEVATED TEMPERATURE LIQUID, FLAMMABLE, N.O.S. with flashpoint above 60°C, at or above i	3		III	Category A	
3257	ELEVATED TEMPERATURE LIQUID, N.O.S. at or above 100°C and below its flashpoint (includin	9		III	Category A SW5	
3258	ELEVATED TEMPERATURE SOLID, N.O.S. at or above 240°C	9		III	Category A SW5	
3259	AMINES, SOLID, CORROSIVE, N.O.S. or POLYAMINES, SOLID, CORROSIVE, N.O.S.	8		I	Category A	SG35
3259	AMINES, SOLID, CORROSIVE, N.O.S. or POLYAMINES, SOLID, CORROSIVE, N.O.S.	8		II	Category A	SG35
3259	AMINES, SOLID, CORROSIVE, N.O.S. or POLYAMINES, SOLID, CORROSIVE, N.O.S.	8		III	Category A	SG35
3260	CORROSIVE SOLID, ACIDIC, INORGANIC, N.O.S.	8		I	Category B	
3260	CORROSIVE SOLID, ACIDIC, INORGANIC, N.O.S.	8		II	Category B	

UN Number	PROPER SHIPPING NAME (Note: When there is more than one packing group or PSN the UN No. has been annotated with a, b, c)	Class or division	Subsidiary risk(s)	Packing Group	Stowage and Handling	Segregation
3260	CORROSIVE SOLID, ACIDIC, INORGANIC, N.O.S.	8		III	Category A	
3261	CORROSIVE SOLID, ACIDIC, ORGANIC, N.O.S.	8		I	Category B	
3261	CORROSIVE SOLID, ACIDIC, ORGANIC, N.O.S.	8		II	Category B	
3261	CORROSIVE SOLID, ACIDIC, ORGANIC, N.O.S.	8		III	Category A	
3262	CORROSIVE SOLID, BASIC, INORGANIC, N.O.S.	8		I	Category B	SG35
3262	CORROSIVE SOLID, BASIC, INORGANIC, N.O.S.	8		II	Category B	SG35
3262	CORROSIVE SOLID, BASIC, INORGANIC, N.O.S.	8		III	Category A	SG35
3263	CORROSIVE SOLID, BASIC, ORGANIC, N.O.S.	8		I	Category B	SG35
3263	CORROSIVE SOLID, BASIC, ORGANIC, N.O.S.	8		II	Category B	SG35
3263	CORROSIVE SOLID, BASIC, ORGANIC, N.O.S.	8		III	Category A	SG35
3264	CORROSIVE LIQUID, ACIDIC, INORGANIC, N.O.S.	8		I	Category B SW2	
3264	CORROSIVE LIQUID, ACIDIC, INORGANIC, N.O.S.	8		II	Category B SW2	
3264	CORROSIVE LIQUID, ACIDIC, INORGANIC, N.O.S.	8		III	Category A SW2	
3265	CORROSIVE LIQUID, ACIDIC, ORGANIC, N.O.S.	8		I	Category B SW2	
3265	CORROSIVE LIQUID, ACIDIC, ORGANIC, N.O.S.	8		II	Category B SW2	
3265	CORROSIVE LIQUID, ACIDIC, ORGANIC, N.O.S.	8		III	Category A SW2	
3266	CORROSIVE LIQUID, BASIC, INORGANIC, N.O.S.	8		I	Category B SW2	SG35
3266	CORROSIVE LIQUID, BASIC, INORGANIC, N.O.S.	8		II	Category B SW2	SG35
3266	CORROSIVE LIQUID, BASIC, INORGANIC, N.O.S.	8		III	Category A SW2	SG35
3267	CORROSIVE LIQUID, BASIC, ORGANIC, N.O.S.	8		I	Category B SW2	SG35
3267	CORROSIVE LIQUID, BASIC, ORGANIC, N.O.S.	8		II	Category B SW2	SG35
3267	CORROSIVE LIQUID, BASIC, ORGANIC, N.O.S.	8		III	Category A SW2	SG35
3268	AIR BAG INFLATORS or AIR BAG MODULES or SEAT-BELT PRETENSIONERS	9		III	Category A	
3269	POLYESTER RESIN KIT	3		II	Category B	
3269	POLYESTER RESIN KIT	3		III	Category A	
3270	NITROCELLULOSE MEMBRANE FILTERS with not more than 12.6% nitrogen, by dry mass	4.1		II	Category D	
3271	ETHERS, N.O.S.	3		II	Category B	
3271	ETHERS, N.O.S.	3		III	Category A	
3272	ESTERS, N.O.S.	3		II	Category B	
3272	ESTERS, N.O.S.	3		III	Category A	
3273	NITRILES, FLAMMABLE, TOXIC, N.O.S.	3	6.1	I	Category E SW2	SG35
3273	NITRILES, FLAMMABLE, TOXIC, N.O.S.	3	6.1	II	Category B SW2	SG35
3274	ALCOHOLATES SOLUTION, N.O.S. in alcohol	3	8	II	Category B	

UN Number	PROPER SHIPPING NAME (Note: When there is more than one packing group or PSN the UN No. has been annotated with a, b, c)	Class or division	Subsidiary risk(s)	Packing Group	Stowage and Handling	Segregation
3275	NITRILES, TOXIC, FLAMMABLE, N.O.S.	6.1	3	I	Category B SW2	SG35
3275	NITRILES, TOXIC, FLAMMABLE, N.O.S.	6.1	3	II	Category B SW2	SG35
3276	NITRILES, TOXIC, LIQUID, N.O.S.	6.1		I	Category B	SG35
3276	NITRILES, TOXIC, LIQUID, N.O.S.	6.1		II	Category B	SG35
3276	NITRILES, TOXIC, LIQUID, N.O.S.	6.1		III	Category A	SG35
3277	CHLOROFORMATES, TOXIC, CORROSIVE, N.O.S.	6.1	8	II	Category A SW1 SW2 H1 H2	
3278	ORGANOPHOSPHORUS COMPOUND, TOXIC, LIQUID, N.O.S.	6.1		I	Category B	
3278	ORGANOPHOSPHORUS COMPOUND, TOXIC, LIQUID, N.O.S.	6.1		II	Category B	
3278	ORGANOPHOSPHORUS COMPOUND, TOXIC, LIQUID, N.O.S.	6.1		III	Category A	
3279	ORGANOPHOSPHORUS COMPOUND, TOXIC, FLAMMABLE N.O.S.	6.1	3	I	Category B SW2	
3279	ORGANOPHOSPHORUS COMPOUND, TOXIC, FLAMMABLE N.O.S.	6.1	3	II	Category B SW2	
3280	ORGANOARSENIC COMPOUND, LIQUID, N.O.S.	6.1		I	Category B	
3280	ORGANOARSENIC COMPOUND, LIQUID, N.O.S.	6.1		II	Category B	
3280	ORGANOARSENIC COMPOUND, LIQUID, N.O.S.	6.1		III	Category A	
3281	METAL CARBONYLS, LIQUID, N.O.S.	6.1		I	Category D SW2	
3281	METAL CARBONYLS, LIQUID, N.O.S.	6.1		II	Category B SW2	
3281	METAL CARBONYLS, LIQUID, N.O.S.	6.1		III	Category B SW2	
3282	ORGANOMETALLIC COMPOUND, TOXIC, LIQUID, N.O.S.	6.1		I	Category B	
3282	ORGANOMETALLIC COMPOUND, TOXIC, LIQUID, N.O.S.	6.1		II	Category B	
3282	ORGANOMETALLIC COMPOUND, TOXIC, LIQUID, N.O.S.	6.1		III	Category A	
3283	SELENIUM COMPOUND, SOLID, N.O.S.	6.1		I	Category B	
3283	SELENIUM COMPOUND, SOLID, N.O.S.	6.1		II	Category B	
3283	SELENIUM COMPOUND, SOLID, N.O.S.	6.1		III	Category A	
3284	TELLURIUM COMPOUND, N.O.S.	6.1		I	Category B	
3284	TELLURIUM COMPOUND, N.O.S.	6.1		II	Category B	
3284	TELLURIUM COMPOUND, N.O.S.	6.1		III	Category A	
3285	VANADIUM COMPOUND, N.O.S.	6.1		I	Category B	
3285	VANADIUM COMPOUND, N.O.S.	6.1		II	Category B	
3285	VANADIUM COMPOUND, N.O.S.	6.1		III	Category A	
3286	FLAMMABLE LIQUID, TOXIC, CORROSIVE, N.O.S.	3	6.1/8	I	Category E SW2	SG5 SG8
3286	FLAMMABLE LIQUID, TOXIC, CORROSIVE, N.O.S.	3	6.1/8	II	Category B SW2	SG5 SG8
3287	TOXIC LIQUID, INORGANIC, N.O.S.	6.1		I	Category B SW2	

UN Number	PROPER SHIPPING NAME (Note: When there is more than one packing group or PSN the UN No. has been annotated with a, b, c)	Class or division	Subsidiary risk(s)	Packing Group	Stowage and Handling	Segregation
3287	TOXIC LIQUID, INORGANIC, N.O.S.	6.1		II	Category B SW2	
3287	TOXIC LIQUID, INORGANIC, N.O.S.	6.1		III	Category A SW2	
3288	TOXIC SOLID, INORGANIC, N.O.S.	6.1		I	Category B	
3288	TOXIC SOLID, INORGANIC, N.O.S.	6.1		II	Category B	
3288	TOXIC SOLID, INORGANIC, N.O.S.	6.1		III	Category A	
3289	TOXIC LIQUID, CORROSIVE, INORGANIC, N.O.S.	6.1	8	I	Category B SW2	
3289	TOXIC LIQUID, CORROSIVE, INORGANIC, N.O.S.	6.1	8	II	Category B SW2	
3290	TOXIC SOLID, CORROSIVE, INORGANIC, N.O.S.	6.1	8	I	Category B SW2	
3290	TOXIC SOLID, CORROSIVE, INORGANIC, N.O.S.	6.1	8	II	Category B SW2	
3291	CLINICAL WASTE, UNSPECIFIED, N.O.S. or (BIO) MEDICAL WASTE, N.O.S. or REGULATED MEDICAL	6.2		II	SW28	
3292	BATTERIES, CONTAINING SODIUM or CELLS, CONTAINING SODIUM	4.3		II	Category A	
3293	HYDRAZINE, AQUEOUS SOLUTION with not more than 37% hydrazine, by mass	6.1		III	Category A	SG35
3294	HYDROGEN CYANIDE, SOLUTION IN ALCOHOL with not more than 45% hydrogen cyanide	6.1	3P	I	Category D SW2	
3295	HYDROCARBONS, LIQUID, N.O.S.	3		I	Category E	
3295	HYDROCARBONS, LIQUID, N.O.S.	3		II	Category B	
3295	HYDROCARBONS, LIQUID, N.O.S.	3		III	Category A	
3296	HEPTAFLUOROPROPANE (REFRIGERANT GAS R 227)	2.2			Category A	
3297	ETHYLENE OXIDE AND CHLOROTETRAFLUOROETHANE MIXTURE with not more than 8.8% ethylene oxide	2.2			Category A	
3298	ETHYLENE OXIDE AND PENTAFLUROETHANE MIXTURE with not more than 7.9% ethylene oxide	2.2			Category A	
3299	ETHYLENE OXIDE AND TETRAFLUROETHANE MIXTURE with not more than 5.6% ethylene oxide	2.2			Category A	
3300	ETHYLENE OXIDE AND CARBON DIOXIDE MIXTURE with more than 87% ethylene oxide	2.3	2.1		Category D SW2	
3301	CORROSIVE LIQUID, SELF-HEATING, N.O.S.	8	4.2	I	Category D	
3301	CORROSIVE LIQUID, SELF-HEATING, N.O.S.	8	4.2	II	Category D	
3302	2-DIMETHYLAMINOETHYL ACRYLATE	6.1		II	Category D SW1	
3303	COMPRESSED GAS, TOXIC, OXIDIZING, N.O.S.	2.3	5.1		Category D SW2	
3304	COMPRESSED GAS, TOXIC, CORROSIVE, N.O.S.	2.3	8		Category D SW2	
3305	COMPRESSED GAS, TOXIC, FLAMMABLE, CORROSIVE, N.O.S.	2.3	2.1/8		Category D SW2	SG4 SG9
3306	COMPRESSED GAS, TOXIC, OXIDIZING, CORROSIVE, N.O.S.	2.3	5.1/8		Category D SW2	SG6 SG19
3307	LIQUEFIED GAS, TOXIC, OXIDIZING, N.O.S.	2.3	5.1		Category D SW2	

UN Number	PROPER SHIPPING NAME (Note: When there is more than one packing group or PSN the UN No. has been annotated with a, b, c.)	Class or division	Subsidiary risk(s)	Packing Group	Stowage and Handling	Segregation
3308	LIQUEFIED GAS, TOXIC, CORROSIVE, N.O.S.	2.3	8		Category D SW2	
3309	LIQUEFIED GAS, TOXIC, FLAMMABLE, CORROSIVE, N.O.S.	2.3	2.1/8		Category D SW2	SG4 SG9
3310	LIQUEFIED GAS, TOXIC, OXIDIZING, CORROSIVE, N.O.S.	2.3	5.1/8		Category D SW2	SG6 SG19
3311	GAS, REFRIGERATED LIQUID, OXIDIZING, N.O.S.	2.2	5.1		Category D	
3312	GAS, REFRIGERATED LIQUID, FLAMMABLE, N.O.S.	2.1			Category D SW2	
3313	ORGANIC PIGMENTS, SELF-HEATING	4.2		II	Category C	
3313	ORGANIC PIGMENTS, SELF-HEATING	4.2		III	Category C	
3314	PLASTICS MOULDING COMPOUND in dough, sheet or extruded rope form, evolving flammable vapour	9		III	Category E SW1 SW6	SG5 SG14
3315	CHEMICAL SAMPLE, TOXIC	6.1		I	Category D SW2	
3316	CHEMICAL KIT or FIRST AID KIT	9			Category A	
3317	2-AMINO-4,6-DINITROPHENOL, WETTED with not less than 20% water, by mass	4.1		I	Category D	SG7 SG30
3318	AMMONIA SOLUTION relative density less than 0.880 at 15°C in water, with more than 50% ammonia	2.3	8		Category D SW2	SG35 SG46
3319	NITROGLYCERIN MIXTURE, DESENSITIZED, SOLID, N.O.S. with more than 2% but not more than 10% nitroglycerin, by mass	4.1			Category E	
3320	SODIUM BOROHYDRIDE AND SODIUM HYDROXIDE SOLUTION with not more than 12% sodium borohydride and not more than 40% sodium hydroxide, by mass	8		II	Category A	SG35
3320	SODIUM BOROHYDRIDE AND SODIUM HYDROXIDE SOLUTION with not more than 12% sodium borohydride and not more than 40% sodium hydroxide, by mass	8		III	Category A	SG35
3321	RADIOACTIVE MATERIAL, LOW SPECIFIC ACTIVITY (LSA-II), non fissile or fissile-excepted	7	See SP172		Category A SW20	
3322	RADIOACTIVE MATERIAL, LOW SPECIFIC ACTIVITY (LSA-III), non fissile or fissile-excepted	7	See SP172		Category A SW20	
3323	RADIOACTIVE MATERIAL, TYPE C PACKAGE, non fissile or fissile-excepted	7	See SP172		Category A SW12	
3324	RADIOACTIVE MATERIAL, LOW SPECIFIC ACTIVITY (LSA-II), FISSILE	7	See SP172		Category A SW12 SW20	
3325	RADIOACTIVE MATERIAL, LOW SPECIFIC ACTIVITY, (LSA-III), FISSILE	7	See SP172		Category A SW12	
3326	RADIOACTIVE MATERIAL, SURFACE CONTAMINATED OBJECTS (SCO-I or SCO-II), FISSILE	7	See SP172		Category A SW12	
3327	RADIOACTIVE MATERIAL, TYPE A PACKAGE, FISSILE, non-special form	7	See SP172		Category A SW12 SW20 SW21	
3328	RADIOACTIVE MATERIAL, TYPE B(U) PACKAGE, FISSILE	7	See SP172		Category A SW12	
3329	RADIOACTIVE MATERIAL, TYPE B(M) PACKAGE, FISSILE	7	See SP172		Category A SW12	
3330	RADIOACTIVE MATERIAL, TYPE C PACKAGE, FISSILE	7	See SP172		Category A SW12	
3331	RADIOACTIVE MATERIAL, TRANSPORTED UNDER SPECIAL ARRANGEMENT, FISSILE	7	See SP172		Category A SW13	

UN Number	PROPER SHIPPING NAME (Note: When there is more than one packing group or PSN the UN No. has been annotated with a, b, c.)	Class or division	Subsidiary risk(s)	Packing Group	Stowage and Handling	Segregation
3332	RADIOACTIVE MATERIAL, TYPE A PACKAGE, SPECIAL FORM, non fissile or fissile-excepted	7	See SP172		Category A	
3333	RADIOACTIVE MATERIAL, TYPE A PACKAGE, SPECIAL FORM, FISSILE	7	See SP172		Category A SW12	
3334	AVIATION REGULATED LIQUID, N.O.S.	9			-	
3335	AVIATION REGULATED SOLID, N.O.S.	9			-	
3336	MERCAPTANS, LIQUID, FLAMMABLE, N.O.S. or MERCAPTAN MIXTURE, LIQUID, FLAMMABLE, N.O.S.	3		I	Category E	SG50 SG57
3336	MERCAPTANS, LIQUID, FLAMMABLE, N.O.S. or MERCAPTAN MIXTURE, LIQUID, FLAMMABLE, N.O.S.	3		II	Category B	SG50 SG57
3336	MERCAPTANS, LIQUID, FLAMMABLE, N.O.S. or MERCAPTAN MIXTURE, LIQUID, FLAMMABLE, N.O.S.	3		III	Category B	SG50 SG57
3337	REFRIGERANT GAS R 404A	2.2			Category A	
3338	REFRIGERANT GAS R 407A	2.2			Category A	
3339	REFRIGERANT GAS R 407B	2.2			Category A	
3340	REFRIGERANT GAS R 407C	2.2			Category A	
3341	THIOUREA DIOXIDE	4.2		II	Category D	
3341	THIOUREA DIOXIDE	4.2		III	Category D	
3342	XANTHATES	4.2		II	Category D SW2	
3342	XANTHATES	4.2		III	Category D SW2	
3343	NITROGLYCERIN MIXTURE, DESENSITIZED, LIQUID, FLAMMABLE, N.O.S. with not more than 30% nitroglycerin, by mass	3			Category D	
3344	PENTAERYTHRITRE TETRANITRATE (PENTAERYTHRITOL TETRANITRATE; PETN) MIXTURE, DESENSITIZED, SOLID, N.O.S. with more than 10% but not more than 20% PETN, by mass	4.1		II	Category E	
3345	PHENOXYACETIC ACID DERIVATIVE PESTICIDE, SOLID, TOXIC	6.1		I	Category A SW2	
3345	PHENOXYACETIC ACID DERIVATIVE PESTICIDE, SOLID, TOXIC	6.1		II	Category A SW2	
3345	PHENOXYACETIC ACID DERIVATIVE PESTICIDE, SOLID, TOXIC	6.1		III	Category A SW2	
3346	PHENOXYACETIC ACID DERIVATIVE PESTICIDE, LIQUID, FLAMMABLE, TOXIC flashpoint less than 23°C	3	6.1	I	Category B SW2	
3346	PHENOXYACETIC ACID DERIVATIVE PESTICIDE, LIQUID, FLAMMABLE, TOXIC flashpoint less than 23°C	3	6.1	II	Category B SW2	
3347	PHENOXYACETIC ACID DERIVATIVE PESTICIDE, LIQUID, TOXIC, FLAMMABLE flashpoint not than 23°C	6.1	3	I	Category B SW2	
3347	PHENOXYACETIC ACID DERIVATIVE PESTICIDE, LIQUID, TOXIC, FLAMMABLE flashpoint not less than 23°C	6.1	3	II	Category B SW2	
3347	PHENOXYACETIC ACID DERIVATIVE PESTICIDE, LIQUID, TOXIC, FLAMMABLE flashpoint not less than 23°C	6.1	3	III	Category A SW2	

UN Number	PROPER SHIPPING NAME (Note: When there is more than one packing group or PSN the UN No. has been annotated with a, b, c.)	Class or division	Subsidiary risk(s)	Packing Group	Stowage and Handling	Segregation
3348	PHENOXYACETIC ACID DERIVATIVE PESTICIDE, LIQUID, TOXIC	6.1		I	Category B SW2	
3348	PHENOXYACETIC ACID DERIVATIVE PESTICIDE, LIQUID, TOXIC	6.1		II	Category B SW2	
3348	PHENOXYACETIC ACID DERIVATIVE PESTICIDE, LIQUID, TOXIC	6.1		III	Category A SW2	
3349	PYRETHROID PESTICIDE, SOLID, TOXIC	6.1		I	Category A SW2	
3349	PYRETHROID PESTICIDE, SOLID, TOXIC	6.1		II	Category A SW2	
3349	PYRETHROID PESTICIDE, SOLID, TOXIC	6.1		III	Category A SW2	
3350	PYRETHROID PESTICIDE, LIQUID, FLAMMABLE, TOXIC flashpoint less than 23°C	3	6.1	I	Category B SW2	
3350	PYRETHROID PESTICIDE, LIQUID, FLAMMABLE, TOXIC flashpoint less than 23°C	3	6.1	II	Category B SW2	
3351	PYRETHROID PESTICIDE, LIQUID, TOXIC, FLAMMABLE flashpoint not less than 23°C	6.1	3	I	Category B SW2	
3351	PYRETHROID PESTICIDE, LIQUID, TOXIC, FLAMMABLE flashpoint not less than 23°C	6.1	3	II	Category B SW2	
3351	PYRETHROID PESTICIDE, LIQUID, TOXIC, FLAMMABLE flashpoint not less than 23°C	6.1	3	III	Category A SW2	
3352	PYRETHROID PESTICIDE, LIQUID, TOXIC	6.1		I	Category B SW2	
3352	PYRETHROID PESTICIDE, LIQUID, TOXIC	6.1		II	Category B SW2	
3352	PYRETHROID PESTICIDE, LIQUID, TOXIC	6.1		III	Category A SW2	
3354	INSECTICIDE GAS, FLAMMABLE, N.O.S.	2.1			Category D	
3355	INSECTICIDE GAS, TOXIC, FLAMMABLE, N.O.S.	2.3	2.1		Category D SW2	
3356	OXYGEN GENERATOR, CHEMICAL	5.1		II	Category D	
3357	NITROGLYCERIN MIXTURE, DESENSITIZED, LIQUID, N.O.S with not more than 30% nitroglycerin.	3		II	Category D	
3358	REFRIGERATING MACHINES containing flammable, non-toxic, liquefied gas	2.1			Category D	
3359	FUMIGATED CARGO TRANSPORT UNIT	9			Category B SW2	
3360	FIBRES, VEGETABLE, DRY	4.1			Category A	
3361	CHLOROSILANES, TOXIC, CORROSIVE, N.O.S.	6.1	8	II	Category C SW2	
3362	CHLOROSILANES, TOXIC, CORROSIVE, FLAMMABLE, N.O.S.	6.1	3/8	II	Category C SW2	SG5 SG8
3363	DANGEROUS GOODS IN MACHINERY or DANGEROUS GOODS IN APPARATUS	9			Category A	
3364	TRINITROPHENOL (PICRIC ACID), WETTED with not less than 10% water, by mass	4.1		I	Category E	SG7 SG30
3365	TRINITROCHLOROBENZENE (PICRYL CHLORIDE), WETTED with not less than 10% water by mass	4.1		I	Category E	SG7 SG30
3366	TRINITROTOLUENE (TNT), WETTED with not less than 10% water, by mass	4.1		I	Category E	SG7 SG30
3367	TRINITROBENZENE, WETTED with not less than 10% water, by mass	4.1		I	Category E	SG7 SG30

UN Number	PROPER SHIPPING NAME (Note: When there is more than one packing group or PSN the UN No. has been annotated with a, b, c.)	Class or division	Subsidiary risk(s)	Packing Group	Stowage and Handling	Segregation
3368	TRINITROBENZOIC ACID, WETTED with not less than 10% water, by mass	4.1		I	Category E	SG7 SG30
3369	SODIUM DINITRO-o-CRESOLATE, WETTED with not less than 10% water, by mass	4.1	6.1P	I	Category E	SG7 SG30
3370	UREA NITRATE, WETTED with not less than 10% water, by mass	4.1		I	Category E	SG7 SG30
3371	2-METHYLBUTANAL	3		II	Category B	
3373	BIOLOGICAL SUBSTANCE, CATEGORY B	6.2			Category C SW2 SW18	
3374	ACETYLENE, SOLVENT FREE	2.1			Category D SW1 SW2	SG46
3375	AMMONIUM NITRATE EMULSION or SUPENSION or GEL intermediate for blasting explosives	5.1		II	Category D SW1	SG16 SG42 SG45 SG47 SG48 SG51 SG56 SG58 SG59 SG61
3376	4-NITROPHENYLHYDRAZINE, with not less than 30% water, by mass	4.1		I	Category E	SG7 SG30
3377	SODIUM PERBORATE MONOHYDRATE	5.1		III	Category A SW1 SW23 H1	SG59
3378	SODIUM CARBONATE PEROXYHYDRATE	5.1		II	Category A SW1 H1	SG59
3378	SODIUM CARBONATE PEROXYHYDRATE	5.1		III	Category A SW1 SW23 H1	SG59
3379	DESENSITIZED EXPLOSIVE, LIQUID, N.O.S.	3		I	Category D	SG30
3380	DESENSITIZED EXPLOSIVE, SOLID, N.O.S.	4.1		I	Category D	SG7 SG30
3381	TOXIC BY INHALATION LIQUID, N.O.S. with an inhalation toxicity lower than or equal to 200 ml/m <sup>3</sup> and saturated vapour concentration greater than or equal to 500 LC50	6.1		I	Category D SW2	
3382	TOXIC BY INHALATION LIQUID, N.O.S. with an inhalation toxicity lower than or equal to 1000 ml/m <sup>3</sup> and saturated vapour concentration greater than or equal to 10 LC50	6.1		I	Category D SW2	
3383	TOXIC BY INHALATION LIQUID, FLAMMABLE, N.O.S. with an inhalation toxicity lower than or equal to 200 ml/m <sup>3</sup> and saturated vapour concentration greater than or equal to 500 LC50	6.1	3	I	Category D SW2	
3384	TOXIC BY INHALATION LIQUID, FLAMMABLE, N.O.S. with an inhalation toxicity lower than or equal to 1000 ml/m <sup>3</sup> and saturated vapour concentration greater than or equal to 10 LC50	6.1	3	I	Category D SW2	
3385	TOXIC BY INHALATION LIQUID, WATER-REACTIVE, N.O.S. with an inhalation toxicity lower than or equal to 200 ml/m <sup>3</sup> and saturated vapour concentration greater than or equal to 500 LC50	6.1	4.3	I	Category D SW2	



UN Number	PROPER SHIPPING NAME (Note: When there is more than one packing group or PSN the UN No. has been annotated with a, b, c)	Class or division	Subsidiary risk(s)	Packing Group	Stowage and Handling	Segregation
3386	TOXIC BY INHALATION LIQUID, WATER-REACTIVE, N.O.S. with an inhalation toxicity lower than or equal to 1000 ml/m <sup>3</sup> and saturated vapour concentration greater than or equal to 10 LC50	6.1	4.3	I	Category D SW2	
3387	TOXIC BY INHALATION LIQUID, OXIDIZING, N.O.S. with an inhalation toxicity lower than or equal to 200 ml/m <sup>3</sup> and saturated vapour concentration greater than or equal to 500 LC50	6.1	4.3	I	Category D SW2	
3388	TOXIC BY INHALATION LIQUID, OXIDIZING, N.O.S. with an inhalation toxicity lower than or equal to 1000 ml/m <sup>3</sup> and saturated vapour concentration greater than or equal to 10 LC50	6.1	5.1	I	Category D SW2	
3389	TOXIC BY INHALATION LIQUID, CORROSIVE, N.O.S. with an inhalation toxicity lower than or equal to 200 ml/m <sup>3</sup> and saturated vapour concentration greater than or equal to 500 LC50	6.1	8	I	Category D SW2	
3390	TOXIC BY INHALATION LIQUID, CORROSIVE, N.O.S. with an inhalation toxicity lower than equal to 1000 ml/m <sup>3</sup> and saturated vapour concentration greater than or equal to 10 LC50	6.1	8	I	Category D SW2	
3391	ORGANOMETALLIC SUBSTANCE, SOLID, PYROPHORIC	4.2		I	Category D	
3392	ORGANOMETALLIC SUBSTANCE, LIQUID, PYROPHORIC	4.2		I	Category D	SG63
3393	ORGANOMETALLIC SUBSTANCE, SOLID, PYROPHORIC, WATER-REACTIVE	4.2	4.3	I	Category D	SG35
3394	ORGANOMETALLIC SUBSTANCE, LIQUID, PYROPHORIC, WATER-REACTIVE	4.2	4.3	I	Category D	SG35 SG63
3395	ORGANOMETALLIC SUBSTANCE, SOLID, WATER-REACTIVE	4.3		I	Category E SW2	SG35
3395	ORGANOMETALLIC SUBSTANCE, SOLID, WATER-REACTIVE	4.3		II	Category E SW2	SG35
3395	ORGANOMETALLIC SUBSTANCE, SOLID, WATER-REACTIVE	4.3		III	Category E SW2	SG35
3396	ORGANOMETALLIC SUBSTANCE, SOLID, WATER-REACTIVE, FLAMMABLE	4.3	4.1	I	Category E SW2	SG35
3396	ORGANOMETALLIC SUBSTANCE, SOLID, WATER-REACTIVE, FLAMMABLE	4.3	4.1	II	Category E SW2	SG35
3396	ORGANOMETALLIC SUBSTANCE, SOLID, WATER-REACTIVE, FLAMMABLE	4.3	4.1	III	Category E SW2	SG35
3397	ORGANOMETALLIC SUBSTANCE, SOLID, WATER-REACTIVE, SELF-HEATING	4.3	4.2	I	Category E SW2	SG35
3397	ORGANOMETALLIC SUBSTANCE, SOLID, WATER-REACTIVE, SELF-HEATING	4.3	4.2	II	Category E SW2	SG35
3397	ORGANOMETALLIC SUBSTANCE, SOLID, WATER-REACTIVE, SELF-HEATING	4.3	4.2	III	Category E SW2	SG35
3398	ORGANOMETALLIC SUBSTANCE, LIQUID, WATER-REACTIVE	4.3		I	Category E SW2	SG35
3398	ORGANOMETALLIC SUBSTANCE, LIQUID, WATER-REACTIVE	4.3		II	Category E SW2	SG35
3398	ORGANOMETALLIC SUBSTANCE, LIQUID, WATER-REACTIVE	4.3		III	Category E SW2	SG35
3399	ORGANOMETALLIC SUBSTANCE, LIQUID, WATER-REACTIVE, FLAMMABLE	4.3	3	I	Category D SW2	SG35

UN Number	PROPER SHIPPING NAME (Note: When there is more than one packing group or PSN the UN No. has been annotated with a, b, c.)	Class or division	Subsidiary risk(s)	Packing Group	Stowage and Handling	Segregation
3399	ORGANOMETALLIC SUBSTANCE, LIQUID, WATER-REACTIVE, FLAMMABLE	4.3	3	II	Category D SW2	SG35
3399	ORGANOMETALLIC SUBSTANCE, LIQUID, WATER-REACTIVE, FLAMMABLE	4.3	3	III	Category E SW2	SG35
3400	ORGANOMETALLIC SUBSTANCE, SOLID, SELF-HEATING	4.2		II	Category C	
3400	ORGANOMETALLIC SUBSTANCE, SOLID, SELF-HEATING	4.2		III	Category C	
3401	ALKALI METAL AMALGAM, SOLID	4.3		I	Category D	SG35
3402	ALKALINE EARTH METAL AMALGAM, SOLID	4.3		I	Category D	SG35
3403	POTASSIUM METAL ALLOYS, SOLID	4.3		I	Category D	SG35
3404	POTASSIUM SODIUM ALLOYS, SOLID	4.3		I	Category D	SG35
3405	BARIUM CHLORATE SOLUTION	5.1	6.1	II	Category A	SG38 SG49 SG62
3405	BARIUM CHLORATE SOLUTION	5.1	6.1	III	Category A	SG38 SG49 SG62
3406	BARIUM PERCHLORATE SOLUTION	5.1	6.1	II	Category A	SG38 SG49 SG62
3406	BARIUM PERCHLORATE SOLUTION	5.1	6.1	III	Category A	SG38 SG49 SG62
3407	CHLORATE AND MAGNESIUM CHLORIDE MIXTURE SOLUTION	5.1		II	Category A	SG38 SG49 SG62
3407	CHLORATE AND MAGNESIUM CHLORIDE MIXTURE SOLUTION	5.1		III	Category A	SG38 SG49 SG62
3408	LEAD PERCHLORATE SOLUTION	5.1	6.1P	II	Category A	SG38 SG49
3408	LEAD PERCHLORATE SOLUTION	5.1	6.1P	III	Category A	SG38 SG49
3409	CHLORONITROBENZENES, LIQUID	6.1		II	Category A	
3410	4-CHLORO-o-TOLUIDINE HYDROCHLORIDE SOLUTION	6.1		III	Category A	
3411	beta-NAPHTHYLAMINE SOLUTION	6.1		II	Category A	
3411	beta-NAPHTHYLAMINE SOLUTION	6.1		III	Category A	
3412	FORMIC ACID with not less than 10% but not more than 85% acid by mass	8		II	Category A SW2	
3412	FORMIC ACID with not less than 5% but less than 10% acid by mass	8		III	Category A SW2	
3413	POTASSIUM CYANIDE SOLUTION	6.1	P	I	Category B	SG35
3413	POTASSIUM CYANIDE SOLUTION	6.1	P	II	Category B	SG35
3413	POTASSIUM CYANIDE SOLUTION	6.1	P	III	Category A	SG35
3414	SODIUM CYANIDE SOLUTION	6.1	P	I	Category B	SG35
3414	SODIUM CYANIDE SOLUTION	6.1	P	II	Category B	SG35
3414	SODIUM CYANIDE SOLUTION	6.1	P	III	Category A	SG35
3415	SODIUM FLUORIDE SOLUTION	6.1		III	Category A	SG35
3416	CHLOROACETOPHENONE, LIQUID	6.1		II	Category D SW1 SW2 H2	

UN Number	PROPER SHIPPING NAME (Note: When there is more than one packing group or PSN the UN No. has been annotated with a, b, c)	Class or division	Subsidiary risk(s)	Packing Group	Stowage and Handling	Segregation
3417	XYLYL BROMIDE, SOLID	6.1		II	Category D SW2	
3418	2,4-TOLUYLENDIAMINE SOLUTION	6.1		III	Category A	
3419	BORON TRIFLUORIDE ACETIC ACID COMPLEX, SOLID	8		II	Category A	
3420	BORON TRIFLUORIDE PROPIONIC ACID COMPLEX, SOLID	8		II	Category A	
3421	POTASSIUM HYDROGEN DIFLUORIDE SOLUTION	8	6.1	II	Category A SW1 SW2	SG35
3421	POTASSIUM HYDROGEN DIFLUORIDE SOLUTION	8	6.1	III	Category A SW1 SW2	SG35
3422	POTASSIUM FLUORIDE SOLUTION	6.1		III	Category A	SG35
3423	TETRAMETHYLAMMONIUM HYDROXIDE, SOLID	8		II	Category A	SG35
3424	AMMONIUM DINITRO-o-CRESOLATE SOLUTION	6.1	P	II	Category B	SG15 SG16 SG30 SG63
3424	AMMONIUM DINITRO-o-CRESOLATE SOLUTION	6.1	P	III	Category A	SG15 SG16 SG30 SG63
3425	BROMOACETIC ACID, SOLID	8		II	Category A	
3426	ACRYLAMIDE SOLUTION	6.1		III	Category A SW1 H2	
3427	CHLOROBENZYL CHLORIDES, SOLID	6.1		III	Category A	
3428	3-CHLORO-4-METHYLPHENYLISOCYANATE, SOLID	6.1		II	Category B SW2	
3429	CHLOROTOLUIDINES, LIQUID	6.1		III	Category A	
3430	XYLENOLS, LIQUID	6.1		II	Category A	
3431	NITROBENZOTRIFLUORIDES, SOLID	6.1		II	Category A SW2	
3432	POLYCHLORINATED BIPHENYLS, SOLID	9	P	II	Category A	SG50
3434	NITROCRESOLS, LIQUID	6.1		III	Category A	
3436	HEXAFLUOROACETONE HYDRATE, SOLID	6.1		II	Category B SW2	
3437	CHLOROCRESOLS, SOLID	6.1		II	Category A SW1 H2	
3438	alpha-METHYLBENZYL ALCOHOL, SOLID	6.1		III	Category A	
3439	NITRILES, TOXIC, SOLID, N.O.S.	6.1		I	Category B	SG35
3439	NITRILES, TOXIC, SOLID, N.O.S.	6.1		II	Category B	SG35
3439	NITRILES, TOXIC, SOLID, N.O.S.	6.1		III	Category A	SG35
3440	SELENIUM COMPOUND, LIQUID, N.O.S.	6.1		I	Category B	
3440	SELENIUM COMPOUND, LIQUID, N.O.S.	6.1		II	Category B	
3440	SELENIUM COMPOUND, LIQUID, N.O.S.	6.1		III	Category A	
3441	CHLORODINITROBENZENES, SOLID	6.1	P	II	Category A	SG15
3442	DICHLOROANILINES, SOLID	6.1	P	II	Category A SW2	
3443	DINITROBENZENES, SOLID	6.1		II	Category A	SG15
3444	NICOTINE HYDROCHLORIDE, SOLID	6.1		II	Category A	
3445	NICOTINE SULPHATE, SOLID	6.1		II	Category A	

UN Number	PROPER SHIPPING NAME (Note: When there is more than one packing group or PSN the UN No. has been annotated with a, b, c)	Class or division	Subsidiary risk(s)	Packing Group	Stowage and Handling	Segregation
3446	NITROTOLUENES, SOLID	6.1		II	Category A	
3447	NITROXYLENES, SOLID	6.1		II	Category A	
3448	TEAR GAS SUBSTANCE, SOLID, N.O.S.	6.1		I	Category D SW2	
3448	TEAR GAS SUBSTANCE, SOLID, N.O.S.	6.1		II	Category D SW2	
3449	BROMOBENZYL CYANIDES, SOLID	6.1		I	Category D SW1 SW2 H2	SG35
3450	DIPHENYLCHLOROARSINE, SOLID	6.1	P	I	Category D SW2	
3451	TOLUIDINES, SOLID	6.1		II	Category A	
3452	XYLIDINES, SOLID	6.1		II	Category A	
3453	PHOSPHORIC ACID, SOLID	8		III	Category A	
3454	DINITROTOLUENES, SOLID	6.1		II	Category A	
3455	CRESOLS, SOLID	6.1	8	II	Category B	
3456	NITROSYLSULPHURIC ACID, SOLID	8		II	Category D SW2	SG6 SG16 SG17 SG19
3457	CHLORONITROTOLUENES, SOLID	6.1	P	III	Category A	SG6 SG8 SG10 SG12
3458	NITROANISOLES, SOLID	6.1		III	Category A	
3459	NITROBROMOBENZENES, SOLID	6.1		III	Category A	
3460	N-ETHYLBENZYL TOLUIDINES, SOLID	6.1		III	Category A	
3462	TOXINS, EXTRACTED FROM LIVING SOURCES, SOLID, N.O.S.	6.1		I	Category B	
3462	TOXINS, EXTRACTED FROM LIVING SOURCES, SOLID, N.O.S.	6.1		II	Category B	
3462	TOXINS, EXTRACTED FROM LIVING SOURCES, SOLID, N.O.S.	6.1		III	Category A	
3463	PROPIONIC ACID with not less than 90% acid by mass	8	3	II	Category A	
3464	ORGANOPHOSPHORUS COMPOUND, TOXIC, SOLID, N.O.S.	6.1		I	Category B	
3464	ORGANOPHOSPHORUS COMPOUND, TOXIC, SOLID, N.O.S.	6.1		II	Category B	
3464	ORGANOPHOSPHORUS COMPOUND, TOXIC, SOLID, N.O.S.	6.1		III	Category A	
3465	ORGANOARSENIC COMPOUND, SOLID, N.O.S.	6.1		I	Category B	
3465	ORGANOARSENIC COMPOUND, SOLID, N.O.S.	6.1		II	Category B	
3465	ORGANOARSENIC COMPOUND, SOLID, N.O.S.	6.1		III	Category A	
3466	METAL CARBONYLS, SOLID, N.O.S.	6.1		I	Category D SW2	
3466	METAL CARBONYLS, SOLID, N.O.S.	6.1		II	Category D SW2	
3466	METAL CARBONYLS, SOLID, N.O.S.	6.1		III	Category D SW2	
3467	ORGANOMETALLIC COMPOUND, TOXIC, SOLID, N.O.S.	6.1		I	Category B	
3467	ORGANOMETALLIC COMPOUND, TOXIC, SOLID, N.O.S.	6.1		II	Category B	

UN Number	PROPER SHIPPING NAME (Note: When there is more than one packing group or PSN the UN No. has been annotated with a, b, c.)	Class or division	Subsidiary risk(s)	Packing Group	Stowage and Handling	Segregation
3467	ORGANOMETALLIC COMPOUND, TOXIC, SOLID, N.O.S.	6.1		III	Category A	
3468	HYDROGEN IN A METAL HYDRIDE STORAGE SYSTEM or HYDROGEN IN A METAL HYDRIDE STORAGE SYSTEM	2.1			Category D	
3469	PAINT, FLAMMABLE, CORROSIVE (including paint, lacquer, enamel, stain, shellac, varnish,	3	8	I	Category E SW2	
3469	PAINT, FLAMMABLE, CORROSIVE (including paint, lacquer, enamel, stain, shellac, varnish,	3	8	II	Category B SW2	
3469	PAINT, FLAMMABLE, CORROSIVE (including paint, lacquer, enamel, stain, shellac, varnish,	3		III	Category A SW2	
3470	PAINT, CORROSIVE, FLAMMABLE (including paint, lacquer, enamel, stain, shellac, varnish,	8	3	II	Category B SW2	
3471	HYDROGENDIFLUORIDES SOLUTION, N.O.S.	8	6.1	II	Category A SW1 SW2	SG35
3471	HYDROGENDIFLUORIDES SOLUTION, N.O.S.	8	6.1	III	Category A SW1 SW2	SG35
3472	CROTONIC ACID, LIQUID	8		III	Category A SW1 H2	
3473	FUEL CELL CARTRIDGES or FUEL CELL CARTRIDGES CONTAINED IN EQUIPMENT or FUEL CELL CARTRID	3			Category A	
3474	1-HYDROXYBENZOTRIAZOLE MONOHYDRATE	4.1		I	Category D	SG7 SG30
3475	ETHANOL AND GASOLINE MIXTURE or ETHANOL AND MOTOR SPIRIT MIXTURE or ETHANOL AND PETROL MIXTURE, with more than 10% ethanol MIXTURE, with more than 10% ethanol	3		II	Category E	
3476	FUEL CELL CARTRIDGES or FUEL CELL CARTRIDGES CONTAINED IN EQUIPMENT or FUEL CELL CARTRIDGES PACKED WITH EQUIPMENT, containing water-reactive substances	4.3			Category A	
3477	FUEL CELL CARTRIDGES or FUEL CELL CARTRIDGES CONTAINED IN EQUIPMENT or FUEL CELL CARTRID	8			Category A	
3478	FUEL CELL CARTRIDGES or FUEL CELL CARTRIDGES CONTAINED IN EQUIPMENT or FUEL CELL CARTRIDGES PACKED WITH EQUIPMENT, containing liquefied flammable gas	2.1			Category B	
3479	FUEL CELL CARTRIDGES or FUEL CELL CARTRIDGES CONTAINED IN EQUIPMENT or FUEL CELL CARTRIDGES PACKED WITH EQUIPMENT, containing hydrogen in metal hydride	2.1			Category B	
3480	LITHIUM ION BATTERIES (including lithium ion polymer batteries)	9		II	Category A	
3481	LITHIUM ION BATTERIES CONTAINED IN EQUIPMENT or LITHIUM ION BATTERIES PACKED WITH EQUIPMENT (including lithium ion polymer batteries)	9		II	Category A	

UN Number	PROPER SHIPPING NAME (Note: When there is more than one packing group or PSN the UN No. has been annotated with a, b, c)	Class or division	Subsidiary risk(s)	Packing Group	Stowage and Handling	Segregation
3482	ALKALI METAL DISPERSION, FLAMMABLE or ALKALINE EARTH METAL DISPERSION, FLAMMABLE	4.3	3	I	Category D	SG35
3483	MOTOR FUEL ANTI-KNOCK MIXTURE, FLAMMABLE	6.1	3	I	Category D SW1 SW2	
3484	HYDRAZINE, AQUEOUS SOLUTION, FLAMMABLE with more than 37% hydrazine, by mass	8	**3/6.1	I	Category D SW2	SG5 SG8 SG35
3485	CALCIUM HYPOCHLORITE, DRY, CORROSIVE or CALCIUM HYPOCHLORITE MIXTURE, DRY, CORROSIVE with more than 39% available chlorine (8.8% available oxygen)	5.1	8	II	Category D SW1 SW11	SG35 SG38 SG49 SG53 SG60
3486	CALCIUM HYPOCHLORITE MIXTURE, DRY, CORROSIVE with more than 10% but not more than 39% available chlorine	5.1	8	III	Category D SW1 SW11	SG35 SG38 SG49 SG53 SG60
3487	CALCIUM HYPOCHLORITE, HYDRATED, CORROSIVE or CALCIUM HYPOCHLORITE, HYDRATED MIXTURE, CORROSIVE, with not less than 5.5% but not more than 16% water	5.1	8	II	Category D SW1 SW11	SG35 SG38 SG49 SG53 SG60
3487	CALCIUM HYPOCHLORITE, HYDRATED, CORROSIVE or CALCIUM HYPOCHLORITE, HYDRATED MIXTURE, CORROSIVE, with not less than 5.5% but not more than 16% water	5.1	8	III	Category D SW1 SW11	SG35 SG38 SG49 SG53 SG60
3488	TOXIC BY INHALATION LIQUID, FLAMMABLE, CORROSIVE, N.O.S. with an LC50 lower than or equal to 200 ml/m3 and saturated vapour concentration greater than or equal to 500 LC50	6.1	**3/8	I	Category D SW2	SG5 SG8
3489	TOXIC BY INHALATION LIQUID, FLAMMABLE, CORROSIVE, N.O.S. with an LC50 lower than or equal to 1000 ml/m3 and saturated vapour concentration greater than or equal to 10 LC50	6.1	**3/8	I	Category D SW2	SG5 SG8
3490	TOXIC BY INHALATION LIQUID, WATER-REACTIVE, FLAMMABLE, N.O.S. with an LC50 lower than or equal to 200 ml/m3 and saturated vapour concentration greater than or equal to 500 LC50	6.1	4.3/3	I	Category D SW2	SG5 SG7 SG13
3491	TOXIC BY INHALATION LIQUID, WATER-REACTIVE, FLAMMABLE, N.O.S. with an LC50 lower than or equal to 1000 ml/m3 and saturated vapour concentration greater than or equal to 10 LC50	6.1	4.3/3	I	Category D SW2	SG5 SG7 SG13
3494	PETROLEUM SOUR CRUDE OIL, FLAMMABLE, TOXIC	3		I	Category D SW2	
3494	PETROLEUM SOUR CRUDE OIL, FLAMMABLE, TOXIC	3		II	Category D SW2	
3494	PETROLEUM SOUR CRUDE OIL, FLAMMABLE, TOXIC	3		III	Category C SW2	
3495	IODINE	8	6.1	III	Category B SW2	SG37

UN Number	PROPER SHIPPING NAME (Note: When there is more than one packing group or PSN the UN No. has been annotated with a, b, c.)	Class or division	Subsidiary risk(s)	Packing Group	Stowage and Handling	Segregation
3496	BATTERIES, NICKEL-METAL HYDRIDE	9			Category A SW1	
3497	KRILL MEAL	4.2		II	Category B SW27	SG65
3497	KRILL MEAL	4.2		III	Category A	
3498	IODINE MONOCHLORIDE, LIQUID	8		II	Category D SW2	SG6 SG16 SG17 SG19
3499	CAPACITOR, electric double layer (with an energy storage capacity greater than 0.3 Wh)	9			Category A	
3500	CHEMICAL UNDER PRESSURE, N.O.S.	2.2			Category B	
3501	CHEMICAL UNDER PRESSURE, FLAMMABLE, N.O.S.	2.1			Category D SW2	
3502	CHEMICAL UNDER PRESSURE, TOXIC, N.O.S.	2.2	6.1		Category D SW2	
3503	CHEMICAL UNDER PRESSURE, CORROSIVE, N.O.S.	2.2	8		Category D SW2	
3504	CHEMICAL UNDER PRESSURE, FLAMMABLE, TOXIC, N.O.S.	2.1	6.1		Category D SW2	
3505	CHEMICAL UNDER PRESSURE, FLAMMABLE, CORROSIVE, N.O.S.	2.1	8		Category D SW2	
3506	MERCURY CONTAINED IN MANUFACTURED ARTICLES	8	6.1	III	Category B SW2	SG24

In the dangerous goods list, amend the following entries as follows:

0005	in column (1) and in column (18), the first existing row in the dangerous goods list "0005" is replaced with "0004".
0082	in column (9), delete "PP65".
0241	in column (9), delete "PP65".
0331	in column (9), delete "PP65".
0332	in column (9), delete "PP65".
0222	Amend column (2) to read "AMMONIUM NITRATE". In column (6) insert "370". In column (10) insert "IBC100"; In column (11), insert "B2, B3, B17".
0503	In column (2), amend name to read: "SAFETY DEVICES, PYROTECHNIC".
1005	in column (4) insert "P"
1008	In column (6), replace "-" with "373"
1043	in column (7b) amend the code to read "E0".
1044	in column (9), insert "PP91".
1051 PG I	in column (7b) amend the code to read "E0".
1082	in column (2), add "(REFRIGERANT GAS R 1113)" at the end.
1089 PG I	in column (7b) amend the code to read "E0".
1098	in column (4) insert "P"
1183 PG I	in column (16a) insert "H1" and in column (16b) "SG25" and "SG26"
1206	in column (4) insert "P".
1210	in column (6), insert "367".
1228 PG II	in column (7b) amend the code to read "E0".
1242 PG I	in column (16a) insert "H1" and in column (16b) "SG25" and "SG26"
1259 PG I	in column (7b) amend the code to read "E0".
1261 PG II	in column (7b) amend the code to read "E0".
1262	in column (4) insert "P"
1263	in column (6), insert "367".
1272	in column (4) insert "P"
1278 PG II	in column (7b) amend the code to read "E0".
1295 PG I	in column (16)a insert "H1" and in column (16b) "SG25" and "SG26"
1299	in column (4) insert "P"



RESOLUTION MSC.372(93)  
(adopted on 22 May 2014)  
AMENDMENTS TO THE INTERNATIONAL MARITIME  
DANGEROUS GOODS (IMDG) CODE

MSC 93/22/Add.2  
Annex 8, page 124

1308 PG I	in column (7b) amend the code to read "E0".
1309 PG II	in column (16a) insert "H1" and in column (16b) "SG25" and "SG26"
1309 PG III	in column (16a) insert "H1" and in column (16b) "SG25" and "SG26"
1323	in column (16a) insert "H1" and in column (16b) "SG25" and "SG26"
1331 PG III	in column (7b) amend the code to read "E0".
1333 PG II	in column (16a) insert "H1" and in column (16b) "SG25" and "SG26"
1334	in column (4) insert "P"
1339 PG II	in column (16a) insert "H1" and in column (16b) "SG25" and "SG26"
1340 PG II	in column (16a) insert "H1" and in column (16b) "SG26"
1343 PG II	in column (16a) insert "H1" and in column (16b) "SG25" and "SG26"
1357	in column (6) delete "919"
1358 PG II	in column (16a) insert "H1" and in column (16b) "SG25" and "SG26"
1360 PG I	in column (16a) insert "H1" and in column (16b) "SG26"
1361 PG II and PG III	in column (7b) amend the code to read "E0".
1363 PG III	in column (7b) amend the code to read "E0".
1364 PG III	in column (7b) amend the code to read "E0".
1365 PG III	in column (7b) amend the code to read "E0".
1373 PG III	in column (7b) amend the code to read "E0".
1376 PG III	in column (7b) amend the code to read "E0"; in column (16a) insert "H1" and in column (16b) "SG26"
1378 PG II	in column (7b) amend the code to read "E0".
1379 PG III	in column (7b) amend the code to read "E0".
1380 PG I	in column (16a) insert "H1" and in column (16b) "SG26"
1383 PG I	in column (16a) insert "H1" and in column (16b) "SG26"
1386 PG III	in column (7b) amend the code to read "E0".
1389 PG I	in column (16a) insert "H1" and in column (16b) "SG26"
1390 PG II	in column (16a) insert "H1" and in column (16b) "SG26"

1391 PG I	in column (16a) insert "H1" and in column (16b) "SG26"
1392 PG I	in column (16a) insert "H1" and in column (16b) "SG26"
1393 PG II	in column (16a) insert "H1" and in column (16b) "SG26"
1394 PG II	in column (16a) insert "H1" and in column (16b) "SG26"
1395 PG II	in column (16a) insert "H1" and in column (16b) "SG26"
1396 PG II	in column (16a) insert "H1" and in column (16b) "SG26"
1396 PG III	in column (16a) insert "H1" and in column (16b) "SG26"
1397 PG I	in column (16a) insert "H1" and in column (16b) "SG26"
1398 PG III	in column (16a) insert "H1" and in column (16b) "SG26"
1400 PG II	in column (16a) insert "H1" and in column (16b) "SG26"
1401 PG II	in column (16a) insert "H1" and in column (16b) "SG26"
1402 PG I	in column (16a) insert "H1" and in column (16b) "SG26"
1402 PG II	in column (16a) insert "H1" and in column (16b) "SG26"
1403 PG III	in column (16a) insert "H1" and in column (16b) "SG26"
1404 PG I	in column (16a) insert "H1" and in column (16b) "SG26"
1405 PG II	in column (16a) insert "H1" and in column (16b) "SG26"
1405 PG III	in column (16a) insert "H1" and in column (16b) "SG26"
1407 PG I	in column (16a) insert "H1" and in column (16b) "SG26"
1408 PG III	in column (16a) insert "H1" and in column (16b) "SG26"
1409 PG I	in column (16a) insert "H1" and in column (16b) "SG26"
1409 PG II	in column (16a) insert "H1" and in column (16b) "SG26"
1410 PG I	in column (16a) insert "H1" and in column (16b) "SG26"
1411 PG I	in column (16a) insert "H1" and in column (16b) "SG26"
1413 PG I	in column (16a) insert "H1" and in column (16b) "SG26"
1414 PG I	in column (16a) insert "H1" and in column (16b) "SG26"

RESOLUTION MSC.372(93)  
(adopted on 22 May 2014)  
AMENDMENTS TO THE INTERNATIONAL MARITIME  
DANGEROUS GOODS (IMDG) CODE

MSC 93/22/Add.2  
Annex 8, page 126

1415 PG I	in column (16a) insert "H1" and in column (16b) "SG26"
1417 PG II	in column (16a) insert "H1" and in column (16b) "SG26"
1418 PG I	in column (16a) insert "H1" and in column (16b) "SG26"
1418 PG II and PG III	in column (16a) insert "H1" and in column (16b) "SG26"
1419 PG I	in column (16a) insert "H1" and in column (16b) "SG26"
1420 PG I	in column (16a) insert "H1" and in column (16b) "SG26"
1421 PG I	in column (16a) insert "H1" and in column (16b) "SG26"
1422 PG I	in column (16a) insert "H1" and in column (16b) "SG26"
1423 PG I	in column (16a) insert "H1" and in column (16b) "SG26"
1426 PG I	in column (16a) insert "H1" and in column (16b) "SG26"
1427 PG I	in column (16a) insert "H1" and in column (16b) "SG26"
1428 PG I	in column (16a) insert "H1" and in column (16b) "SG26"
1432 PG I	in column (16a) insert "H1" and in column (16b) "SG26"
1433 PG I	in column (16a) insert "H1" and in column (16b) "SG26"
1435 PG III	in column (16a) insert "H1" and in column (16b) "SG26"
1436 PG I, II and PG III	in column (16a) insert "H1" and in column (16b) "SG26"
1449 PG II	in column (16a) replace "Category "A" with "Category C"; in column (16a) insert "H1" and in column (16b) "SG26"
1457 PG II	in column (16a) replace "Category "A" with "Category C" and insert "H1"; in column (16b) "SG26"
1472 PG II	in column (16a) replace "Category "A" with "Category C" and insert "H1"; in column (16b) "SG26"
1476 PG II	in column (16a) replace "Category "A" with "Category C" and insert "H1"; in column (16b) "SG26"
1483 PG II and III	in column (16a) replace "Category "A" with "Category C" and insert "H1"; in column (16b) "SG26"
1491 PG I	in column (16a) replace "Category "B" with "Category C" and insert "H1"; in column (16b) "SG26"

1504 PG I	in column (16a) replace "Category B" with "Category C" and insert "H1"; in column (16b) "SG26"
1509 PG II	in column (16a) replace "Category A" with "Category C" and insert "H1"; in column (16b) "SG26"
1516 PG II	in column (16a) replace "Category A" with "Category C" and insert "H1"; in column (16b) "SG26"
1545 PG II	in column (7b) amend the code to read "E0".
1547	in column (4) insert "P"
1560 PG I	in column (7b) amend the code to read "E0".
1567 PG II	in column (16a) insert "H1" and in column (16b) "SG25" and "SG26"
1569 PG II	in column (7b) amend the code to read "E0".
1583 all packing groups	in column (7b) amend the code to read "E0".
1600	in column (4) insert "P"
1603 PG II	in column (7b) amend the code to read "E0".
1613 PG I	in column (7b) amend the code to read "E0".
1614 PG I	in column (7b) amend the code to read "E0".
1649 PG I	in column (7b) amend the code to read "E0".
1672 PG I	in column (7b) amend the code to read "E0".
1693 PG I and PG II	in column (7b) amend the code to read "E0".
1694 PG I	in column (7b) amend the code to read "E0".
1697 PG II	in column (7b) amend the code to read "E0".
1698 PG I	in column (7b) amend the code to read "E0".
1699 PG I	in column (7b) amend the code to read "E0".
1700	in column (5), delete the packing group.
1701 PG II	in column (7b) amend the code to read "E0".
1708	in column (4) insert "P"
1714 PG I	in column (16a) insert "H1" and in column (16b) "SG26"
1722 PG I	in column (7b) amend the code to read "E0".
1732 PG II	in column (7b) amend the code to read "E0".
1748	in column (4) insert "P"

1792 PG II	in column (7b) amend the code to read "E0".
1796 PG II	in column (7b) amend the code to read "E0".
1802 PG II	in column (7b) amend the code to read "E0".
1806 PG II	in column (7b) amend the code to read "E0".
1808 PG II	in column (7b) amend the code to read "E0".
1826 PG II	in column (7b) amend the code to read "E0".
1832 PG II	in column (7b) amend the code to read "E0".
1837 PG II	in column (7b) amend the code to read "E0".
1840	in column (4) insert "P"
1854 PG I	in column (16a) insert "H1" and in column (16b) "SG26"
1855 PG I	in column (16a) insert "H1" and in column (16b) "SG26"
1868 PG II	in column (7b) amend the code to read "E0".
1869 PG III	in column (16a) insert "H1" and in column (16b) "SG25" and "SG26"
1870 PG I	in column (16a) insert "H1" and in column (16b) "SG26"
1889 PG I	in column (7b) amend the code to read "E0".
1906 PG II	in column (7b) amend the code to read "E0".
1920	in column (4) insert "P"
1928 PG I	in column (16a) insert "H1" and in column (16b) "SG26"
1932 PG III	in column (7b) amend the code to read "E0"; in column (16a) insert "H1" and in column (16b) "SG26"
1939 PG II	in column (7b) amend the code to read "E0".
1942	Amend column (2) to read "AMMONIUM NITRATE with not more than 0.2% combustible substances, including any organic substance calculated as carbon, to the exclusion of any other added substance".
2002 PG III	in column (7b) amend the code to read "E0".
2004 PG II	in column (16a) insert "H1" and in column (16b) "SG26"
2006 PG III	in column (7b) amend the code to read "E0".
2008 PG II and III	in column (16a) insert "H1" and in column (16b) "SG26"
2009 PG III	in column (16a) insert "H1" and in column (16b) "SG26"

2010 PG I	in column (16a) insert "H1" and in column (16b) "SG26"
2011 PG I	in column (16a) insert "H1" and in column (16b) "SG26"
2012 PG I	in column (16a) insert "H1" and in column (16b) "SG26"
2013 PG I	in column (16a) insert "H1" and in column (16b) "SG26"
2016	in column (5), delete the packing group.
2017	in column (5), delete the packing group.
2030 PG II	in column (7b) amend the code to read "E0".
2038	in column (4) insert "P"
2073	in column (7b) amend the code to read "E0". in column (4) insert "P"
2208	in column (4) insert "P"
2210 PG III	in column (16a) insert "H1" and in column (16b) "SG26"
2212 PG II	in column (2) amend the name to read "ASBESTOS, AMPHIBOLE (amosite, tremolite, actinolite, anthophyllite, crocidolite)"; in column (6) insert "274"; in column (7b) amend the code to read "E0"; in column (16a) insert "H4"; in column (17) delete the fifth sentence "Crocidolite (blue asbestos) should be regarded as the most hazardous type of asbestos." and the last two sentences "If cleaning of cargo spaces must be carried out at sea, the safety procedures followed and standard of equipment used must be at least as effective as those which would be employed in a port. Until such cleaning is undertaken, the cargo spaces in which the asbestos has been carried should be closed and access to those spaces should be prohibited."
2217 PG III	in column (7b) amend the code to read "E0".
2218	in column (4) insert "P"
2241	in column (4) insert "P"
2249 PG I	in column (7b) amend the code to read "E0".
2254 PG III	in column (7b) amend the code to read "E0".
2257 PG I	in column (16a) insert "H1" and in column (16b) "SG26"
2295 PG I	in column (7b) amend the code to read "E0".
2304	in column (4) insert "P"
2325	in column (4) insert "P"
2331	in column (4) insert "P"

2363 PG I	in column (7b) amend the code to read "E0".
2368	in column (4) insert "P"
2381 PG II	in column (4) insert "P" in column (7b) amend the code to read "E0".
2404 PG II	in column (7b) amend the code to read "E0".
2438 PG I	in column (7b) amend the code to read "E0".
2441 PG I	in column (16a) insert "H1" and in column (16b) "SG26"
2442 PG II	in column (7b) amend the code to read "E0".
2443 PG II	in column (7b) amend the code to read "E0".
2463 PG I	in column (16a) insert "H1" and in column (16b) "SG26"
2466 PG I	in column (16a) replace "Category E" with "Category D" and insert "H1"; in column (16b) "SG26"
2545 PG I, PG II and III	in column (16a) insert "H1" and in column (16b) "SG26"
2546 PG I, PG II and III	in column (16a) insert "H1" and in column (16b) "SG26"
2547 PG I	in column (16a) replace "Category E" with "Category D" and insert "H1"; in column (16b) "SG26"
2558 PG I	in column (7b) amend the code to read "E0".
2590	in column (2) amend the name to read "ASBESTOS, CHRYSOTILE"; In column (16a) insert "H4" in column (17) delete the last two sentences "If cleaning of cargo spaces must be carried out at sea, the safety procedures followed and standard of equipment used must be at least as effective as those which would be employed in a port. Until such cleaning is undertaken, the cargo spaces in which the asbestos has been carried should be closed and access to those spaces should be prohibited."
2624 PG II	in column (16a) insert "H1" and in column (16b) "SG26"
2626 PG II	in column (7b) amend the code to read "E0".
2672	in column (4) insert "P"
2691 PG II	in column (7b) amend the code to read "E0".
2709	in column (4) insert "P".
2740 PG I	in column (7b) amend the code to read "E0".
2743 PG II	in column (7b) amend the code to read "E0".

2749 PG I	in column (7b) amend the code to read "E0".
2793 PG III	in column (16a) insert "H1" and in column (16b) "SG26"
2798 PG II	in column (7b) amend the code to read "E0".
2799 PG II	in column (7b) amend the code to read "E0".
2805 PG II	in column (16a) insert "H1" and in column (16b) "SG26"
2813 PG I, II and PG III	in column (16a) insert "H1" and in column (16b) "SG26"
2826 PG II	in column (7b) amend the code to read "E0".
2830 PG II	in column (16a) insert "H1" and in column (16b) "SG26"
2835 PG II	in column (7b) amend the code to read "E0". in column (16a) insert "H1" and in column (16b) "SG26"
2844 PG III	in column (16a) insert "H1" and in column (16b) "SG26"
2845 PG I	in column (16a) insert "H1" and in column (16b) "SG26"
2846 PG I	in column (16a) insert "H1" and in column (16b) "SG26"
2850	in column (4) insert "P"
2858 PG III	in column (16a) insert "H1" and in column (16b) "SG25" and "SG26"
2870 PG I (both entries)	in column (16a) insert "H1" and in column (16b) "SG26"
2878 PG III	in column (16a) insert "H1" and in column (16b) "SG25" and "SG26"
2880 all packing groups	in column (4) insert "P"
2881 PG II	in column (7b) amend the code to read "E0".
2881 PG I, II and PG III	in column (16a) insert "H1" and in column (16b) "SG25" and "SG26"
2910	in column (6) delete "325" and insert "368"
2950 PG III	in column (16a) insert "H1" and in column (16b) "SG26"
2956 PG III	in column (7b) amend the code to read "E0".
2965 PG I	in column (16a) insert "H1" and in column (16b) "SG25" and "SG26"
2968 PG III	in column (16a) insert "H1" and in column (16b) "SG26"



2977	in column (6) delete special provision "172".
2978	in column (6) delete special provision "172".
2988	in column (16a) insert "H1" and in column (16b) "SG25" and "SG26"
3048 PG I	in column (7b) amend the code to read "E0".
3066	in column (6), insert "367".
3077	in column (6), insert "969".
3078 PG II	in column (16a) insert "H1" and in column (16b) "SG26"
3082	in column (6) insert "969".
3089 PG II	in column (16a) insert "H1" and in column (16b) "SG25" and "SG26"
3089 PG III	in column (10) replace "IBC 06" by "IBC 08"; in column (11) insert "B2 and B4" in column (16a) insert "H1" and in column (16b) "SG25" and "SG26"
3090	in column (5), delete the packing group; in column (6) delete "957" and insert "376" and "377"; in column (8) insert "P908, P909", "LP903" and "LP904"; in column (16a) insert "SW19".
3091	in column (5), delete the packing group, in column (6) delete "957" and insert "376" and "377", in column (8) insert "P908, P909", "LP903" and "LP904" in column (16a) insert "SW19".
3094 PG I and PG II	in column (16a) insert "H1" and in column (16b) "SG26"
3096 PG I and PG II	in column (16a) insert "H1" and in column (16b) "SG26"
3097 PG II and PG III	in column (7b) amend the code to read "E0".
3100 PG II	in column (7b) amend the code to read "E0".
3121 PG I and PG II	in column (16a) insert "H1" and in column (16b) "SG26"
3121 PG II	in column (7b) amend the code to read "E0".
3122 PG I	in column (7b) amend the code to read "E0".
3123 PG I and PG II	in column (16a) insert "H1" and in column (16b) "SG26"
3123 PG I	in column (7b) amend the code to read "E0".
3125 PG I and II	in column (16a) insert "H1" and in column (16b) "SG26"

3127 PG II and PG III	in column (7b) amend the code to read "E0".
3129 PG I, PG II and PG III	in column (16a) insert "H1" and in column (16b) "SG26"
3129 PG II	in column (7b) amend the code to read "E0".
3130 PG I, PG II and PG III	in column (16a) insert "H1" and in column (16b) "SG26"
3130 PG II	in column (7b) amend the code to read "E0".
3131 PG I, II and PG III	in column (16a) insert "H1" and in column (16b) "SG26"
3132 PG I, II and PG III	in column (16a) insert "H1" and in column (16b) "SG26"
3133 PG II and PG III	in column (7b) amend the code to read "E0". in column (16a) insert "H1" and in column (16b) "SG26"
3134 PG I, II and PG III	in column (16a) insert "H1" and in column (16b) "SG26"
3135 PG I, II and PG III	in column (16a) insert "H1" and in column (16b) "SG26"
3137 PG I	in column (16a) insert "H1" and in column (16b) "SG25" and "SG26"
3148 PG I, PG II and PG III	in column (16a) insert "H1" and in column (16b) "SG26"
3164	in column (6), insert "371".
3166	in column (6) insert "SP 970".
3170 PG II and PG III	in column (16a) insert "H1" and in column (16b) "SG26"
3189 PG II and III	in column (16a) insert "H1" and in column (16b) "SG26"
3194 PG I	in column (16a) insert "H1" and in column (16b) "SG26"
3200 PG I	in column (16a) insert "H1" and in column (16b) "SG26"
3208 PG I and III	in column (16a) insert "H1" and in column (16b) "SG26"

RESOLUTION MSC.372(93)  
(adopted on 22 May 2014)  
AMENDMENTS TO THE INTERNATIONAL MARITIME  
DANGEROUS GOODS (IMDG) CODE

MSC 93/22/Add.2  
Annex 8, page 134

3208 PG II	in column (7b) amend the code to read "E0"; in column (16a) insert "H1" and in column (16b) "SG26"
3209 PG I, PG II and PG III	in column (16a) insert "H1" and in column (16b) "SG26"
3242 PG II	in column (7b) amend the code to read "E0".
3251 PG III	in column (7b) amend the code to read "E0".
3268	in column (2), amend the name to read: "SAFETY DEVICES, electrically initiated" and in column (5), delete the packing group.
3292	in column (5), delete the packing group; in column (16a) insert "H1" and in column (16b) "SG26"
3294 PG I	in column (7b) amend the code to read "E0".
3315 PG I	in column (7b) amend the code to read "E0".
3316	delete the existing entry (note: the replacement for this entry is shown in the table for new entries)
3318	in column (4) insert "P"
3336 PG I	in column (7b) amend the code to read "E0".
3356	in column (5), delete the packing group.
3375	In column (8), replace "P099" by "P505"; in column (10) replace "IBC99" by "IBC02" and in column (11), insert "B16".
3378 PG II	In column (6) delete "967". (Amendment applies to the printed version only)
3385 PG I	in column (16a) insert "H1" and in column (16b) "SG26"
3386 PG I	in column (16a) insert "H1" and in column (16b) "SG26"
3391 PG I	in column (16a) insert "H1" and in column (16b) "SG26"
3392 PG I	in column (16a) insert "H1" and in column (16b) "SG26"
3393 PG I	in column (14) Insert "TP41". in column (16a) insert "H1" and in column (16b) "SG26"
3394 PG I	in column (14) Insert "TP41"; in column (16a) insert "H1" and in column (16b) "SG26"
3395 all packing groups	in column (14) Insert "TP41"; in column (16a) insert "H1" and in column (16b) "SG26"
3396 all packing groups	in column (14) Insert "TP41"; in column (16a) insert "H1" and in column (16b) "SG26"

3397 all packing groups	in column (14) Insert "TP41"; in column (16a) insert "H1" and in column (16b) "SG26"
3398 all packing groups	in column (14) Insert "TP41"; in column (16a) insert "H1" and in column (16b) "SG26"
3399 all packing groups	in column (14) Insert "TP41"; in column (16a) insert "H1" and in column (16b) "SG26"
3401 PG I	in column (16a) insert "H1" and in column (16b) "SG26"
3402 PG I	in column (16a) insert "H1" and in column (16b) "SG26"
3403 PG I	in column (16a) insert "H1" and in column (16b) "SG26"
3404 PG I	in column (16a) insert "H1" and in column (16b) "SG26"
3416 PG II	in column (7b) amend the code to read "E0".
3422	In column (15) replace "S-B" with "S-A".
3448 PG I and PG II	in column (7b) amend the code to read "E0".
3450 PG I	in column (7b) amend the code to read "E0".
3451	in column (4) insert "P"
3454	in column (4) insert "P"
3469	in column (6), insert "367".
3470	in column (6), insert "367".
3476	in column (16a) insert "H1" and in column (16b) "SG26"
3480	in column (5), delete the packing group; in column (6) delete "957" and insert "376" and "377"; in column (8) insert "P908, P909", "LP903" and "LP904"; in column (16a) insert "SW19".
3481	in column (5), delete the packing group; in column (6) delete "957" and insert "376" and "377"; in column (8) insert "P908, P909", "LP903" and "LP904" in column (16) insert "SW19".
3482 PG I	in column (16a) insert "H1" and in column (16b) "SG26"
3483 PG I	in column (7b) amend the code to read "E0"
3485	in column (4) insert "P"
3486	in column (4) insert "P"

MSC 93/22/Add.2  
Annex 8, page 136

---

3487 all packing groups	in column (4) insert "P"
3490 PG I	in column (16a) insert "H1" and in column (16b) "SG25" and "SG26"
3491 PG I	in column (16a) insert "H1" and in column (16b) "SG25" and "SG26"
3498 PG II	in column (7b) amend the code to read "E0"
3499	In column (2) amend the proper shipping name to read as follows: "CAPACITOR, ELECTRIC DOUBLE LAYER (with an energy storage capacity greater than 0.3Wh)"
3506	in column (5), delete the packing group.

3.2.1 Dangerous Goods List

(1)	(2)	(3)	(4)	(5)	(6)	(7a)	(7b)	(8)	(9)	(10)	(11)	(12)	(13)	(14)	(15)	(16a)	(16b)	(17)
3316		9	-	II	251 340	See SP SP 251	340	P901	-	-	-	-	-	-	F.A, S-P	Category A.		-
3316	CHEMICAL KIT or FIRST AID KIT	9		III	251 340	See SP See SP 251	340	P901	-	-	-	-	-	-	F.A, S-P	Category A.		-
3507	URANIUM HEXAFLUORIDE, RADIOACTIVE MATERIAL, EXCEPTED PACKAGE, less than 0.1 kg per package, non-fissile or fissile-excepted	8	7	I	317 369	0	E0	P805	-	-	-	-	-	-	F-I, S-S	Category A, SW12		See 1.5.1.
3508	CAPACITOR, ASYMMETRIC (with an energy storage capacity greater than 0.3Wh)	9	-	-	372	0	E0	P003	-	-	-	-	-	-	-	Category A		Articles intended to store energy containing positive and negative electrodes comprised of different materials and an electrolyte. Asymmetric capacitors may be transported in a charged state.
3509	PACKAGING DISCARDED, EMPTY, UNCLEANED	9			968	0	E0	-	-	-	-	-	-	-	-	-		This entry shall not be used for sea transport. Discarded packaging shall meet the requirements of 4.1.1, 11. Discarded packaging means packagings, large packagings or intermediate bulk containers (IBC), or parts thereof, which have contained dangerous goods, other than radioactive material, which are transported for disposal, recycling or recovery of their material, other than reconditioning, repair, routine maintenance, remanufacturing or reuse, and which have been emptied to the extent that only residues of dangerous goods adhering to the packaging parts are present.
3510	ADSORBED GAS, FLAMMABLE, N.O.S.	2.1	-	-	274	0	E0	P208	-	-	-	-	-	-	F-D, S-U	Category D, SW2		-
3511	ADSORBED GAS, N.O.S.	2.2		-	274		E0	P208	-	-	-	-	-	-	F-C, S-V	Category A.		-
3512	ADSORBED GAS, TOXIC, N.O.S.	2.3		-	274	0	E0	P208	-	-	-	-	-	-	F-C, S-U	Category D, SW2		-
3513	ADSORBED GAS, OXIDIZING, N.O.S.	2.2	5.1	-	274	0	E0	P208	-	-	-	-	-	-	F-C, S-W	Category D.		-
3514	ADSORBED GAS, TOXIC, FLAMMABLE, N.O.S.	2.3	2.1	-	274	0	E0	P208	-	-	-	-	-	-	F-D, S-U	Category D, SW2		-
3515	ADSORBED GAS, TOXIC, OXIDIZING, N.O.S.	2.3	5.1	-	274	0	E0	P208	-	-	-	-	-	-	F-C, S-W	Category D, SW2		-
3516	ADSORBED GAS, TOXIC, CORROSIVE, N.O.S.	2.3	8	-	274	0	E0	P208	-	-	-	-	-	-	F-C, S-U	Category D, SW2		-
3517	ADSORBED GAS, TOXIC, FLAMMABLE, CORROSIVE, N.O.S.	2.3	2.1 8	-	274	0	E0	P208	-	-	-	-	-	-	F-D, S-U	Category D, SW2	SG4 SG9	-

MSC 93/22/Add.2  
Annex 8, page 138

(1)	(2)	(3)	(4)	(5)	(6)	(7a)	(7b)	(8)	(9)	(10)	(11)	(12)	(13)	(14)	(15)	(16a)	(16b)	(17)
3518	ADSORBED GAS, TOXIC, OXIDIZING, CORROSIVE, N.O.S.	2.3 5.1 8	5.1 8	-	274	0	E0	P208	-	-	-	-	-	-	F-C, S-W	Category D, SW2	SG6 SG19	-
3519	BORON TRIFLUORIDE, ADSORBED	2.3	8	-	-	0	E0	P208	-	-	-	-	-	-	F-C, S-U	Category D, SW2		Non-flammable, toxic and corrosive gas. Forms dense white corrosive fumes in moist air. Reacts violently with water, evolving hydrogen fluoride, an irritating and corrosive gas apparent as white fumes. In the presence of moisture, highly corrosive to glass and most metals. Much heavier than air (2.35). Highly irritating to skin, eyes and mucous membranes.
3520	CHLORINE, ADSORBED	2.3	5.1 8	-	-	0	E0	P208	-	-	-	-	-	-	F-C, S-W	Category D, SW2	SG6 SG19	Non-flammable, toxic and corrosive yellow gas with a pungent odour. Corrosive to glass and to most metals. Much heavier than air (2.4). Highly irritating to skin, eyes and mucous membranes. Powerful oxidant which may cause fire.
3521	SILICON TETRAFLUORIDE, ADSORBED	2.3	8	-	-	0	E0	P208	-	-	-	-	-	-	F-C, S-U	Category D, SW2		Non-flammable, toxic and corrosive gas with a pungent odour. Corrosive to metals. In moist air, produces hydrogen fluoride. Much heavier than air (3.6). Highly irritating to skin, eyes and mucous membranes.
3522	ARSINE, ADSORBED	2.3	2.1	-	-	0	E0	P208	-	-	-	-	-	-	F-D, S-U	Category D, SW2.		Flammable, toxic, colourless gas with a garlic odour. Explosive limits: 3.9% to 77.8%. Much heavier than air (2.8).
3523	GERMANE, ADSORBED	2.3	2.1	-	-	0	E0	P208	-	-	-	-	-	-	F-D, S-U	Category D, SW2		Flammable, toxic, colourless gas with a pungent odour. Much heavier than air (2.6)
3524	PHOSPHORUS PENTAFLUORIDE, ADSORBED	2.3	8	-	-	0	E0	P208	-	-	-	-	-	-	F-C, S-U	Category D, SW2		Non-flammable, toxic and corrosive gas with an irritating odour. Reacts with water or moist air to produce toxic and corrosive fumes. Corrosive to glass and to most metals. Much heavier than air (4.3). Highly irritating to skin, eyes and mucous membranes.
3525	PHOSPHINE, ADSORBED	2.3	2.1	-	-	0	E0	P208	-	-	-	-	-	-	F-D, S-U	Category D, SW2		Flammable, toxic, colourless gas with a garlic odour. Ignites spontaneously in air. Heavier than air (1.2). Irritating to skin, eyes and mucous membranes.
3526	HYDROGEN SELENIDE, ADSORBED	2.3	2.1	-	-	0	E0	P208	-	-	-	-	-	-	F-D, S-U	Category D, SW2		Flammable, toxic, colourless gas with a disagreeable odour. Much heavier than air (2.8). Highly irritating to skin, eyes and mucous membranes.

---

### Chapter 3.3 – Special provisions applicable to certain substances, materials or articles

Amend the following Special Provisions as indicated hereunder:

SP 66 Amend to read as follows:

"Cinnabar is not subject to the provisions of this Code".

SP 122 At the end, add: ", 4.1.4.2 packing instruction IBC520 and 4.2.5.2.6 portable tank instruction T23."

SP 135 Amend to read as follows:

"135 The dihydrated sodium salt of dichloroisocyanuric acid does not meet the criteria for inclusion in Class 5.1 and is not subject to the provisions of this Code unless meeting the criteria for inclusion in another Class or Division."

SP 172 Amend to read as follows:

"172 Where a radioactive material has (a) subsidiary risk(s):

- .1 The substance shall be allocated to Packing Group I, II or III, if appropriate, by application of the packing group criteria provided in part 2 corresponding to the nature of the predominant subsidiary risk;
- .2 Packages shall be labelled with subsidiary risk labels corresponding to each subsidiary risk exhibited by the material; corresponding placards shall be affixed to cargo transport units in accordance with the relevant provisions of 5.3.1;
- .3 For the purposes of documentation and package marking, the proper shipping name shall be supplemented with the name of the constituents which most predominantly contribute to this (these) subsidiary risk(s) and which shall be enclosed in parenthesis;
- .4 The dangerous goods transport document shall indicate the subsidiary class or division and, where assigned the packing group as required by 5.4.1.4.1.4 and 5.4.1.4.1.5.

For packing, see also 4.1.9.1.5."

SP 225 At the end, add:

"Fire extinguishers shall be manufactured, tested, approved and labelled according to the provisions applied in the country of manufacture. Fire extinguishers under this entry include:

- .1 portable fire extinguishers for manual handling and operation;
- .2 fire extinguishers for installation in aircraft;



- .3 fire extinguishers mounted on wheels for manual handling;
- .4 fire extinguishing equipment or machinery mounted on wheels or wheeled platforms or units transported similar to (small) trailers, and
- .5 fire extinguishers composed of a non-rollable pressure drum and equipment, and handled e.g. by fork lift or crane when loaded or unloaded."

SP 235 Amend to read as follows:

"235 This entry applies to articles which contain Class 1 explosive substances and which may also contain dangerous goods of other classes. These articles are used to enhance safety in vehicles, vessels or aircraft – e.g. air bag inflators, air bag modules, seat-belt pretensioners, and pyromechanical devices."

SP 251 Insert the following new third paragraph after "to any individual substance in the kit":

"Where the kit contains only dangerous goods to which no packing group is assigned, no packing group need be indicated on the dangerous goods transport document."

SP 280 Amend to read as follows:

"280 This entry applies to safety devices for vehicles, vessels or aircraft, e.g. air bag inflators, air bag modules, seat-belt pretensioners, and pyromechanical devices, which contain dangerous goods of Class 1 or of other classes, when transported as component parts and if these articles as presented for transport have been tested in accordance with Test Series 6(c) of Part 1 of the Manual of Tests and Criteria, with no explosion of the device, no fragmentation of device casing or pressure receptacle, and no projection hazard nor thermal effect which would significantly hinder fire-fighting or emergency response efforts in the immediate vicinity. This entry does not apply to life saving appliances described in special provision 296 (UN Nos. 2990 and 3072)."

SP 289 Amend to read as follows:

"289 Safety devices, electrically initiated and safety devices, pyrotechnic installed in vehicles, vessels or aircraft or in completed components such as steering columns, door panels, seats, etc. are not subject to the provisions of this Code."

SP 306 Amend to read as follows:

"306 This entry may only be used for substances that are too insensitive for acceptance into Class 1 when tested in accordance with Test Series 2 (see Manual of Tests and Criteria, Part I)."

SP 309 Amend the last sentence to read as follows:

"Substances shall satisfactorily pass Tests 8(a), (b) and (c) of Test Series 8 of the Manual of Tests and Criteria, Part I, Section 18 and be approved by the competent authority."

---

SP 310 At the end, include a new "Note" to read as follows:

"For damage or defective lithium batteries and cells see SP 376"

SP 361 At the end of subparagraph .5 insert "except those manufactured before 1 January 2014;"

SP 363 In subparagraph .3, replace "loaded in an orientation" with "oriented"

SP 919 is deleted.

SP 957 Is deleted.

SP 961 Replace existing 961 with the following:

"SP 961 Internal combustion engines, fuel cell engines, vehicles, and battery-powered equipment are not subject to the provisions of this Code if any of the following conditions are met:

- .1 Internal combustion engines, fuel cell engines vehicles, and battery-powered equipment are stowed on the vehicle, special category and ro-ro spaces or on the weather deck of a roll-on/roll-off ship or a cargo space designated by the Administration (flag State) in accordance with SOLAS 74, chapter II-2, regulation 20 as specifically designed and approved for the carriage of vehicles and there are no signs of leakage from the battery, engine, fuel cell, compressed gas cylinder or accumulator, or fuel tank when applicable. When packed in a cargo transport unit the exception does not apply to container cargo spaces of a ro-ro ship. Vehicles powered solely by lithium batteries and hybrid electric vehicles powered by both an internal combustion engine and lithium metal or ion batteries, the battery is of a type proved to meet the requirements of the United Nations Manual of Tests and Criteria, part III, subsection 38.3, unless otherwise approved by the competent Authority;
- .2 Internal combustion engines, vehicles powered by a flammable liquid fuel with a flashpoint of 38°C or above, there are no leaks in any portion of the fuel system, the fuel tank(s) contains 450 l of fuel or less and installed batteries are protected from short-circuit.
- .3 Internal combustion engines with a fuel tank attached and vehicles powered by a flammable liquid fuel with a flashpoint less than 38°C, the fuel tank(s) are empty and installed batteries are protected from short circuit. The internal combustion engines or vehicle are considered to be empty of flammable liquid fuel when the fuel tank has been drained and the vehicle cannot be operated due to a lack of fuel. Engine components such as fuel lines, fuel filters and injectors do not need to be cleaned, drained or purged to be considered empty. The fuel tank does not need to be cleaned or purged;
- .4 Internal combustion engines with an attached fuel tank and vehicles powered by a flammable gas (liquefied or compressed), the fuel tank(s) are empty and the positive pressure in the tank does not exceed 2 bar, the fuel shut-off or isolation valve is closed and secured, and installed batteries are protected from short circuit;

- .5 Vehicles or battery powered equipment solely powered by a wet or dry electric storage battery or a sodium battery, and the battery is protected from short circuit;
- .6 Internal combustion engines powered by a flammable liquid or flammable gas have been cleaned, drained and purged of all flammable liquids and gases or the engine has been sealed to prevent leakage of any residues; or
- .7 Fuel cell engines are protected from inadvertent operation by closing fuel supply lines or by other means and the fuel supply reservoir has been drained and sealed. The fuel supply reservoir does not need to be cleaned or purged.

Notwithstanding above, dangerous goods required for the operation of the internal combustion engines or the vehicle or for the safety of the operator such as fire extinguishers, compressed gas cylinders, accumulators, airbag inflators, starter batteries, etc., shall be securely mounted. All other dangerous goods in the vehicle shall be separately packaged and consigned for transport, as appropriate, in accordance with this Code.

For fuel cell engines, all dangerous goods other than fuel and fuel cells shall be separately packaged and consigned for transport, as appropriate, in accordance with this Code."

SP 962 Replace 962 with the following:

"SP 962 internal combustion engines, vehicles, fuel cell engines, or battery powered equipment not meeting the conditions of special provision 961 shall be assigned to class 9 and shall meet the following requirements:

- .1 internal combustion engines, vehicles, combustion engines, fuel cell engines or battery powered equipment shall not show signs of leakage from batteries, engines, fuel cells, compressed gas cylinders or accumulators, or fuel tank(s) when applicable;
- .2 for flammable liquid powered vehicles and internal combustion engines the fuel tank(s) containing the flammable liquid shall not be more than one fourth full and in any case the flammable liquid shall not exceed 250 l unless otherwise approved by the competent authority;
- .3 for flammable gas powered vehicles and internal combustion engines, the fuel shut-off valve of the fuel tank(s) shall be securely closed;
- .4 installed batteries shall be protected from damage, short circuit, and accidental activation during transport. Lithium ion or lithium metal batteries shall be of a type proved to meet the requirements of the United Nations Manual of Tests and Criteria, part III, subsection 38.3, unless otherwise approved by the competent authority; and

Notwithstanding above dangerous goods required for the operation of the internal combustion engines or the vehicle or for the safety of the operator

such as fire extinguishers, compressed gas accumulators, airbag inflators, starter batteries, etc., shall be securely mounted.

The provisions of this Code relevant to marking, labelling, placarding and marine pollutants shall not apply."

SP 963 Replace the words "column 16" with "columns 16a and 16b"

Insert the following new special provisions:

"367 For the purposes of documentation and package marking:

The proper shipping name "Paint related material" may be used for consignments of packages containing "Paint" and "Paint related material" in the same package;

The proper shipping name "Paint related material, corrosive, flammable" may be used for consignments of packages containing "Paint, corrosive, flammable" and "Paint related material, corrosive, flammable" in the same package;

The proper shipping name "Paint related material, flammable, corrosive" may be used for consignments of packages containing "Paint, flammable, corrosive" and "Paint related material, flammable, corrosive" in the same package; and

The proper shipping name "Printing ink related material" may be used for consignments of packages containing "Printing Ink" and "Printing ink related material" in the same package."

"368 In the case of non-fissile or fissile-excepted uranium hexafluoride, the material shall be classified under UN 3507 or UN 2978."

"369 In accordance with 2.0.3.5, this radioactive material in an excepted package possessing corrosive properties is classified in Class 8 with a radioactive material subsidiary risk.

Uranium hexafluoride may be classified under this entry only if the conditions of 2.7.2.4.1.2, 2.7.2.4.1.5, 2.7.2.4.5.2 and, for fissile-excepted material, of 2.7.2.3.6 are met.

In addition to the provisions applicable to the transport of Class 8 substances, the provisions of 5.1.3.2, 5.1.5.2.2, 5.1.5.4.1.2, 7.1.4.5.9, 7.1.4.5.10, 7.1.4.5.12, and 7.8.4.1 to 7.8.4.6 shall apply.

No Class 7 label is required to be displayed."

"370 This entry applies to:

- ammonium nitrate with more than 0.2% combustible substances, including any organic substance calculated as carbon, to the exclusion of any added substance; and
- ammonium nitrate with not more than 0.2% combustible substances, including any organic substance calculated as carbon, to the exclusion of any added substance, that is not too sensitive for acceptance into

Class 1 when tested in accordance with Test Series 2 (see Manual of Tests and Criteria, Part I). See also UN No. 1942."

- "371 .1 This entry also applies to articles, containing a small pressure receptacle with a release device. Such articles shall comply with the following requirements:
- (a) The water capacity of the pressure receptacle shall not exceed 0.5 litres and the working pressure shall not exceed 25 bar at 15°C;
  - (b) The minimum burst pressure of the pressure receptacle shall be at least four times the pressure of the gas at 15°C;
  - (c) Each article shall be manufactured in such a way that unintentional firing or release is avoided under normal conditions of handling, packing, transport and use. This may be fulfilled by an additional locking device linked to the activator;
  - (d) Each article shall be manufactured in such a way as to prevent hazardous projections of the pressure receptacle or parts of the pressure receptacle;
  - (e) Each pressure receptacle shall be manufactured from material which will not fragment upon rupture;
  - (f) The design type of the article shall be subjected to a fire test. For this test, the provisions of paragraphs 16.6.1.2 except letter g, 16.6.1.3.1 to 16.6.1.3.6, 16.6.1.3.7 (b) and 16.6.1.3.8 of the Manual of Tests and Criteria shall be applied. It shall be demonstrated that the article relieves its pressure by means of a fire degradable seal or other pressure relief device, in such a way that the pressure receptacle will not fragment and that the article or fragments of the article do not rocket more than 10 m;
  - (g) The design type of the article shall be subjected to the following test. A stimulating mechanism shall be used to initiate one article in the middle of the packaging. There shall be no hazardous effects outside the package such as disruption of the package, metal fragments or a receptacle which passes through the packaging.
- .2 The manufacturer shall produce technical documentation of the design type, manufacture as well as the tests and their results. The manufacturer shall apply procedures to ensure that articles produced in series are made of good quality, conform to the design type and are able to meet the requirements in .1. The manufacturer shall provide such information to the Competent Authority on request."

"372 This entry applies to asymmetric capacitors with an energy storage capacity greater than 0.3 Wh. Capacitors with an energy storage capacity of 0.3 Wh or less are not subject to the provisions of this Code.

Energy storage capacity means the energy stored in a capacitor, as calculated according to the following equation,

$$Wh = 1/2C_N(U_R^2 - U_L^2) \times (1/3600),$$

using the nominal capacitance ( $C_N$ ), rated voltage ( $U_R$ ) and rated lower limit voltage ( $U_L$ ).

All asymmetric capacitors to which this entry applies shall meet the following conditions:

- (a) Capacitors or modules shall be protected against short circuit;
- (b) Capacitors shall be designed and constructed to safely relieve pressure that may build up in use, through a vent or a weak point in the capacitor casing. Any liquid which is released upon venting shall be contained by packaging or by equipment in which a capacitor is installed;
- (c) Capacitors shall be marked with the energy storage capacity in Wh, except those manufactured before 1 January 2016;
- (d) Capacitors containing an electrolyte meeting the classification criteria of any class or division of dangerous goods shall be designed to withstand a 95 kPa pressure differential;

Capacitors containing an electrolyte not meeting the classification criteria of any class or division of dangerous goods, including when configured in a module or when installed in equipment are not subject to other provisions of this Code. Capacitors containing an electrolyte meeting the classification criteria of any class or division of dangerous goods, with an energy storage capacity of 20 Wh or less, including when configured in a module, are not subject to other provisions of this Code when the capacitors are capable of withstanding a 1.2 metre drop test unpackaged on an unyielding surface without loss of contents.

Capacitors containing an electrolyte meeting the classification criteria of any class or division of dangerous goods that are not installed in equipment and with an energy storage capacity of more than 20 Wh are subject to this Code.

Capacitors installed in equipment and containing an electrolyte meeting the classification criteria of any class or division of dangerous goods, are not subject to other provisions of these Regulations provided that the equipment is packaged in a strong outer packaging constructed of suitable material, and of adequate strength and design, in relation to the packaging's intended use and in such a manner as to prevent accidental functioning of capacitors during transport. Large robust equipment containing capacitors may be offered for transport unpackaged or on pallets when capacitors are afforded equivalent protection by the equipment in which they are contained.

Note: Notwithstanding the provisions of this special provision, nickel-carbon asymmetric capacitors containing Class 8 alkaline electrolytes shall be transported as UN 2795, BATTERIES, WET, FILLED WITH ALKALI, electric storage."

"373 Neutron radiation detectors containing non-pressurized boron trifluoride gas may be transported under this entry provided that the following conditions are met:

- .1 Each radiation detector shall meet the following conditions.
- (i) The pressure in each detector shall not exceed 105 kPa absolute at 20°C;
  - (ii) The amount of gas shall not exceed 13 g per detector;
  - (iii) Each detector shall be manufactured under a registered quality assurance programme;

**NOTE:** The application of ISO 9001:2008 may be considered acceptable for this purpose.

- (iv) Each neutron radiation detector shall be of welded metal construction with brazed metal to ceramic feed through assemblies. These detectors shall have a minimum burst pressure of 1800 kPa as demonstrated by design type qualification testing; and
  - (v) Each detector shall be tested to a  $1 \times 10^{-10}$  cm<sup>3</sup>/s leaktightness standard before filling.
- .2 Radiation detectors transported as individual components shall be transported as follows:
- (i) Detectors shall be packed in a sealed intermediate plastics liner with sufficient absorbent material to absorb the entire gas contents;
  - (ii) They shall be packed in strong outer packaging. The completed package shall be capable of withstanding a 1.8 m drop test without leakage of gas contents from detectors;
  - (iii) The total amount of gas from all detectors per outer packaging shall not exceed 52 g.
- .3 Completed neutron radiation detection systems containing detectors meeting the conditions of paragraph (a) shall be transported as follows:
- (i) The detectors shall be contained in a strong sealed outer casing;
  - (ii) The casing shall contain sufficient absorbent material to absorb the entire gas contents;
  - (iii) The completed systems shall be packed in strong outer packagings capable of withstanding a 1.8 m drop test without leakage unless a system's outer casing affords equivalent protection.

Packing instruction P200 of 4.1.4.1 is not applicable.

The transport document shall include the following statement "Transport in accordance with special provision 373".

Neutron radiation detectors containing not more than 1 g of boron trifluoride, including those with solder glass joints, are not subject to this Code provided they

meet the requirements in paragraph .1 and are packed in accordance with paragraph .2. Radiation detection systems containing such detectors are not subject to this Code provided they are packed in accordance with paragraph .3.

Nuclear radiation detectors shall be stowed in accordance with stowage Category A."

"SP 376 Lithium ion cells or batteries and lithium metal cells or batteries identified as being damaged or defective such that they do not conform to the type tested according to the applicable provisions of the Manual of Tests and Criteria shall comply with the requirements of this special provision.

For the purposes of this special provision, these may include, but are not limited to:

- Cells or batteries identified as being defective for safety reasons;
- Cells or batteries that have leaked or vented;
- Cells or batteries that cannot be diagnosed prior to transport; or
- Cells or batteries that have sustained physical or mechanical damage.

**NOTE:** In assessing a battery as damaged or defective, the type of battery and its previous use and misuse shall be taken into account.

Cells and batteries shall be transported according to the provisions applicable to UN 3090, UN 3091, UN 3480 and UN 3481, except special provision 230 and as otherwise stated in this special provision.

Packages shall be marked "DAMAGED/DEFECTIVE LITHIUM-ION BATTERIES" or "DAMAGED/DEFECTIVE LITHIUM METAL BATTERIES", as applicable.

Cells and batteries shall be packed in accordance with packing instructions P908 of 4.1.4.1 or LP904 of 4.1.4.3, as applicable.

Cells and batteries liable to rapidly disassemble, dangerously react, produce a flame or a dangerous evolution of heat or a dangerous emission of toxic, corrosive or flammable gases or vapours under normal conditions of transport shall not be transported except under conditions specified by the competent authority."

"SP 377 Lithium ion and lithium metal cells and batteries and equipment containing such cells and batteries transported for disposal or recycling, either packed together with or packed without non-lithium batteries, may be packaged in accordance with packing instruction P909 of 4.1.4.1.

These cells and batteries are not subject to the requirements of section 2.9.4.

Packages shall be marked "LITHIUM BATTERIES FOR DISPOSAL" or "LITHIUM BATTERIES FOR RECYCLING".

Identified damaged or defective batteries shall be transported in accordance with special provision 376 and packaged in accordance with P908 of 4.1.4.1 or LP904 of 4.1.4.3, as applicable."



"SP 968 This entry shall not be used for sea transport. Discarded packaging shall meet the requirements of 4.1.1.11."

"SP 969 Substances classified in accordance to 2.9.3 are subject to the provisions for marine pollutants. Substances which are transported under UN 3077 and 3082 but which do not meet the criteria of 2.9.3 (see 2.9.2.2) are not subject to the provisions for marine pollutants. However for substances that are identified as marine pollutants in this Code (see Index) but which no longer meet the criteria of 2.9.3, the provisions of 2.10.2.6 apply."

"SP 970 This entry only applies to internal combustion engines (including machinery or equipment powered by such engines) to fuel cell engines, and to vehicles powered by flammable liquid, flammable gas and fuel cells containing flammable liquid or gas (including hybrid electric vehicles, see SP 312 or SP 240). For the purposes of this entry vehicles are defined as road vehicles (e.g. cars, motorcycles), boats, aircraft, wheeled or tracked construction or farming equipment and any other self-propelled apparatus designed to carry one or more persons or goods. For internal combustion engines where the requirement of Special Provisions 961 or 962 are not met, an appropriate name and description shall be selected and the relevant provisions of this Code shall apply. If a vehicle is powered by a flammable liquid and a flammable gas internal combustion engine, it shall be assigned to UN 3166 VEHICLE, FLAMMABLE GAS POWERED."

## **Chapter 3.4 – Dangerous goods packed in limited quantities**

### **3.4.1 General**

3.4.1.2 In subparagraph ".5" delete the reference "5.3.2.3".

### **3.4.3 Stowage**

3.4.3 In the paragraph, replace the words "column 16" with "column 16a".

### **3.4.4 Segregation**

3.4.4.1 In subparagraph ".2" replace the words "column 16" with "column 16b"

### **3.4.5 Marking and placarding**

Amend section 3.4.5.1 and 3.4.5.2 to read as follows:

#### **"3.4.5 Marking and Placarding**

3.4.5.1 Except for air transport, packages containing dangerous goods in limited quantities shall bear the marking shown below:

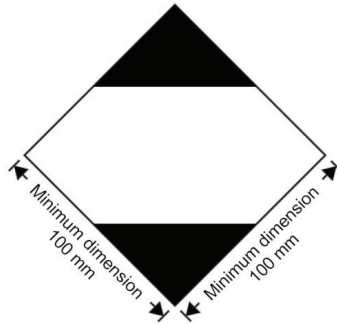

Marking for packages containing limited quantities

The marking shall be readily visible, legible and able to withstand open weather exposure without a substantial reduction in effectiveness. The marking shall be in the form of a square set at an angle of 45° (diamond-shaped). The top and bottom portions and the surrounding line shall be black. The centre area shall be white or a suitable contrasting background. The minimum dimensions shall be 100 mm x 100 mm and the minimum width of the line forming the diamond shall be 2 mm. Where dimensions are not specified, all features shall be in approximate proportion to those shown. If the size of the package so requires, the minimum outer dimensions shown above may be reduced to be not less than 50 mm x 50 mm provided the marking remains clearly visible. The minimum width of the line forming the diamond may be reduced to a minimum of 1 mm.

**NOTE:** The provisions of 3.4.5.1 of the IMDG Code amendment 36-12 may continue to be applied until 31 December 2016."

3.4.5.2 Packages containing dangerous goods packed in conformity with the provisions of Part 3, Chapter 4 of the ICAO Technical Instructions for the Transport of Dangerous Goods may bear the marking shown below to certify conformity with these provisions:

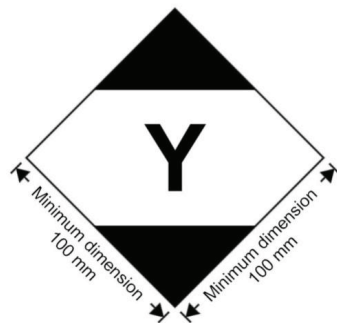

Marking for packages containing limited quantities conforming to Part 3, Chapter 4 of the ICAO Technical Instructions for the Safe Transport of Dangerous Goods by Air.

The marking shall be readily visible, legible and able to withstand open weather exposure without a substantial reduction in effectiveness. The marking shall be in the form of a square set at an angle of 45° (diamond-shaped). The top and bottom portions and the surrounding line shall be black. The centre area shall be white or a suitable contrasting background. The minimum dimensions shall be 100 mm x 100 mm and the minimum width of the line forming the diamond shall be 2 mm. The symbol "Y" shall be placed in the centre of the mark and shall be clearly visible. Where dimensions are not specified, all features shall be in approximate proportion to those shown. If the size of the package so requires, the minimum outer dimensions shown above may be reduced to be not less than 50 mm x 50 mm provided the marking remains clearly visible. The minimum width of the line forming the diamond may be reduced to a minimum of 1 mm. The symbol "Y" shall remain in approximate proportion to that shown above.

**Note:** The provisions of 3.4.5.2 of IMDG Code (amendment 36-12) may continue to be applied until 31 December 2016."

3.4.5.3 Amend to read as follows:

**"3.4.5.3 Multimodal recognition of marks**

3.4.5.3.1 Packages containing dangerous goods bearing the marking shown in 3.4.5.2 with or without the additional labels and markings for air transport shall be deemed to meet the provisions of section 3.4.2 and need not bear the marking shown in 3.4.5.1.

3.4.5.3.2 Packages containing dangerous goods in limited quantities bearing the marking shown in 3.4.5.1 and conforming with the provisions of the ICAO Technical Instructions for the Safe Transport of Dangerous Goods by Air, including all necessary marks and labels specified in Parts 5 and 6, shall be deemed to meet the provisions of section 3.4.1 as appropriate and of section 3.4.2."

**3.4.5.5 Placarding and marking of cargo transport units**

3.4.5.5.3 Delete the existing paragraph and insert "reserve"

**Chapter 3.5 – Dangerous goods packed in excepted quantities**

**3.5.4 Marking of packages**

3.5.4.1 Delete the mark and the text below the mark.

3.5.4.2 and 3.5.4.3 Amend to read as follows:

3.5.4.2

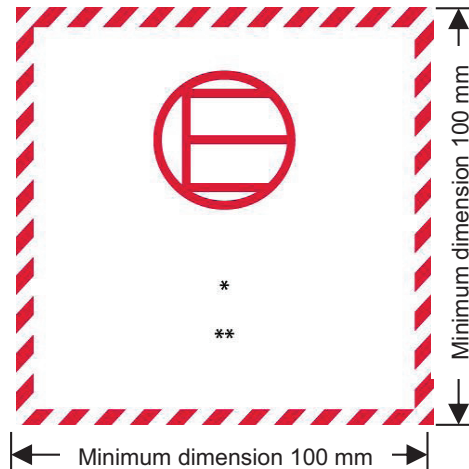

Excepted quantities mark

- \* The Class or, when assigned, the Division number(s) shall be shown in this location.
- \*\* The name of the consignor or of the consignee shall be shown in this location if not shown elsewhere on the package.

The marking shall be in the form of a square. The hatching and symbol shall be of the same colour, black or red, on white or suitable contrasting background. The minimum dimensions shall be 100 mm x 100 mm. Where dimensions are not specified, all features shall be in approximate proportion to those shown.

3.5.4.3 An overpack containing dangerous goods in excepted quantities shall display the markings required by 3.5.4.1, unless such markings on packages within the overpack are clearly visible.

**Note:** The provisions of 3.5.4.1 and 3.5.4.2 of the IMDG Code (amendment 36-12) may continue to be applied until 31 December 2016."

### 3.5.7 Stowage

3.5.7.1 In the paragraph, replace the words "column 16" with "column 16a"

### 3.5.8 Segregation

3.5.8.1 In the paragraph, replace the words "column 16" with "column 16b"

3.5.8.2 In the paragraph, replace the words "column 16" with "column 16b"

**Appendix A – List of generic and N.O.S. Proper Shipping Names**

Add the following new entries in appendix A under the appropriate class in the general entries section:

Class or Division	Subsidiary Risk	UN No	Proper Shipping Name
2.1		3510	ADSORBED GAS, FLAMMABLE, N.O.S.
2.2		3511	ADSORBED GAS, N.O.S.
2.3		3512	ADSORBED GAS, TOXIC, N.O.S.
2.2	5.1	3513	ADSORBED GAS, OXIDIZING, N.O.S.
2.3	2.1	3514	ADSORBED GAS, TOXIC, FLAMMABLE, N.O.S.
2.3	5.1	3515	ADSORBED GAS, TOXIC, OXIDIZING, N.O.S.
2.3	8	3516	ADSORBED GAS, TOXIC, CORROSIVE, N.O.S.
2.3	2.1 + 8	3517	ADSORBED GAS, TOXIC, FLAMMABLE, CORROSIVE, N.O.S.
2.3	5.1 + 8	3518	ADSORBED GAS, TOXIC, OXIDIZING, CORROSIVE, N.O.S.

**Appendix B – Glossary of terms**

Amend the entry for "AIR BAG INFLATORS, PYROTECHNIC or AIR BAG MODULES, PYROTECHNIC or SEAT-BELT PRETENSIONERS, PYROTECHNIC" to read:

"SAFETY DEVICES, electrically initiated".

Amend the definition to read as follows:

"Articles which contain pyrotechnic substances or dangerous goods of other classes and are used in vehicles, vessels or aircraft to enhance safety to persons. Examples are: air bag inflators, air bag modules, seat-belt pretensioners and pyromechanical devices. These pyromechanical devices are assembled components for tasks such as but not limited to separation, locking, or release-and-drive or occupant restraint. The term includes "SAFETY DEVICES, PYROTECHNIC"."

## Alphabetical index

Amend the following entries as indicated hereunder:

Amend the entries for "AIR BAG INFLATORS, PYROTECHNIC or AIR BAG MODULES, PYROTECHNIC or SEAT-BELT PRETENSIONERS, PYROTECHNIC" to read as follows:

«Air bag inflators, see	1.4G 9	0503 3268»
«Air bag modules, see	1.4G 9	0503 3268»
«Seat-belt pretensioners, see	1.4G 9	0503 3268»

In the entries for "Actinolite", "Anthophyllite" and "Tremolite" in the UN No. column, replace "2590" with "2212".

Delete the entries for "Asbestos, blue or brown", "Asbestos, white", "Chrysotile", , "BLUE ASBESTOS (crocidolite)", "BROWN ASBESTOS (amosite, mysorite)", "WHITE ASBESTOS (chrysotile, actinolite, anthophyllite, tremolite)". (delete entries regardless names in the UN Regulations differs from those in the IMDG Code)

In the entry for "TRIFLUOROCHLOROETHYLENE, STABILIZED" UN No. 1082, add at the end "(REFRIGERANT GAS R 1113)".

In the entry for "AMMONIUM NITRATE", (UN 1942), amend the description to read as follows "AMMONIUM NITRATE with not more than 0.2% combustible substances, including any organic substance calculated as carbon, to the exclusion of any other added substance".

In the entry for "AMMONIUM NITRATE", (UN 0222), amend the description to read as follows "AMMONIUM NITRATE".

In the entry for "CAPACITOR, electric double layer..." (UN 3499), amend the description to read as follows: "CAPACITOR, ELECTRIC DOUBLE LAYER (with an energy storage capacity greater than 0.3Wh)".

Drazoxolon: Replace "see PESTICIDE, N.O.S." with "see ORGANOCHLORINE PESTICIDE".

Kelevan: Replace "see PESTICIDE, N.O.S." with "see ORGANOCHLORINE PESTICIDE".

Nabam: Replace "see THIOCARBAMATE PESTICIDE" with "see Note 1".

Oxamyl: Replace "see PESTICIDE, N.O.S." with "see CARBAMATE PESTICIDE".

In the entry for "AMMONIA, ANHYDROUS", UN (1005), insert "P" in the column for MP.

In the entries for "ALLYL ALCOHOL" and "Propenyl alcohol", UN (1098), insert "P" in the column for MP.

In the entry for "HEPTANES", UN (1206), insert "P" in the column for MP.

In the entries for "Hexane" and "2-Methylpentane", UN (1208), insert "P" in the column for MP.

In the entries for "Isooctane", "2-Methylheptane", "OCTANES" and "2,2,4-Trimethylpentane", UN (1262), insert "P" in the column for MP.

In the entry for "PINE OIL", UN (1272), insert "P" in the column for MP.

In the entry for "TURPENTINE", UN (1299), insert "P" in the column for MP.

In the entries for "Creosote salts", "NAPHTHALENE, CRUDE" and "NAPHTHALENE, REFINED", UN (1334), insert "P" in the column for MP.

In the entries for "Aminobenzene", "ANILINE", "Aniline oil" and "Phenylamine", UN (1547), insert "P" in the column for MP.

In the entries for "Methyldinitrobenzenes, molten" and "DINITROTOLUENES, MOLTEN", UN (1600), insert "P" in the column for MP.

In the entry for "TOLUIDINES, LIQUID", UN (1708), insert "P" in the column for MP.

In the entries for "CALCIUM HYPOCHLORITE, DRY with more than 39% available chlorine (8.8% available oxygen)" and "CALCIUM HYPOCHLORITE MIXTURE, DRY with more than 39% available chlorine (8.8% available oxygen)", UN (1748), insert "P" in the column for MP.

In the entry for "Sodium hypochlorite solution", UN (1791), insert "P" in the column for MP.

In the entry for "ZINC CHLORIDE SOLUTION", UN (1840), insert "P" in the column for MP.

In the entry for "NONANES", UN (1920), insert "P" in the column for MP.

Insert a new entry "2,4-Dichlorophenol,see," in the column for Substance, material or article, "P" in the column for MP, "6.1" in the column for Class, "2020" in the column for UN No..

In the entry for "DINITROTOLUENES, LIQUID" and "Methyldinitrobenzenes, liquid", UN (2038), insert "P" in the column for MP.

Insert a new entry "1,3-Dichloropropene, see" in the column for Substance, material or article, "P" in the column for MP, "3" in the column for Class, "2047" in the column for UN No..

In the entry for "AMMONIA SOLUTION relative density less than 0.880 at 15°C in water, with more than 35% but not more than 50% ammonia", UN (2073), insert "P" in the column for MP.

In the entries for "Bleaching powder" and "CALCIUM HYPOCHLORITE MIXTURE, DRY with more than 10% but not more than 39% available chlorine", UN (2208), insert "P" in the column for MP.

In the entries for "Propenoic acid, stabilized", "Acroleic acid, stabilized" and "ACRYLIC ACID, STABILIZED", UN (2218), insert "P" in the column for MP.

In the entries for "meta-Chlorotoluene" and "para-Chlorotoluene", delete "P", and in the entry for "ortho-Chlorotoluene", UN (2238) insert "P" in the column for MP.

In the entry for "CYCLOHEPTANE", UN (2241), insert "P" in the column for MP.

In the entry for "NAPHTHALENE, MOLTEN", UN (2304), insert "P" in the column for MP.

In the entries for "1,3,5-TRIMETHYLBENZENE" and "Mesitylene", UN (2325), insert "P" in the column for MP.

In the entry for "ZINC CHLORIDE, ANHYDROUS", UN (2331), insert "P" in the column for MP.

In the entry for "alpha-PINENE", UN (2368), insert "P" in the column for MP.

In the entries for "DIMETHYL DISULPHIDE", "Methyl disulphide" and "Methyldithiomethane", UN (2381), insert "P" in the column for MP.

In the entry for "AMMONIA SOLUTION relative density between 0.880 and 0.957 at 15°C in water, with more than 10% but not more than 35% ammonia, by mass", UN (2672), insert "P" in the column for MP.

In the entries for "BUTYLBENZENES", "Isobutylbenzene", "2-Methyl-2-phenylpropane", "1-Phenylbutane" and "2-Phenylbutane", UN (2709), insert "P" in the column for MP.

In the entries for "Dodecene", "PROPYLENE TETRAMER" and "Tetrapropylene", UN (2850), insert "P" in the column for MP.

In the entries for "CALCIUM HYPOCHLORITE, HYDRATED with not less than 5.5% but not more than 16% water" and "CALCIUM HYPOCHLORITE, HYDRATED MIXTURE with not less than 5.5% but not more than 16% water", UN (2880), insert "P" in the column for MP.

In the entry for "AMMONIA SOLUTION relative density less than 0.880 at 15° C in water, with more than 50% ammonia", UN (3318), insert "P" in the column for MP.

In the entry for "TOLUIDINES, SOLID", UN (3451), insert "P" in the column for MP.

In the entries for "DINITROTOLUENES, SOLID" and "Methyldinitrobenzenes, solid", UN (3454), insert "P" in the column for MP.

In the entry for "CALCIUM HYPOCHLORITE MIXTURE, DRY, CORROSIVE with more than 39% available chlorine (8.8% available oxygen)", UN (3485), insert "P" in the column for MP.

In the entry for "CALCIUM HYPOCHLORITE MIXTURE, DRY, CORROSIVE with more than 10% but not more than 39% available chlorine", UN (3486), insert "P" in the column for MP.

In the entries for "CALCIUM HYPOCHLORITE, HYDRATED MIXTURE, CORROSIVE with not less than 5.5% but not more than 16% water" and "CALCIUM HYPOCHLORITE, HYDRATED, CORROSIVE with not less than 5.5% but not more than 16% water", UN (3487), insert "P" in the column for MP.



MSC 93/22/Add.2  
Annex 8, page 156

Add the following new entries in alphabetical order:

<i>Name and description</i>	<i>Class</i>	<i>UN No.</i>
ADSORBED GAS, FLAMMABLE, N.O.S.	2.1	3510
ADSORBED GAS, N.O.S.	2.2	3511
ADSORBED GAS, OXIDIZING, N.O.S.	2.2	3513
ADSORBED GAS, TOXIC, CORROSIVE, N.O.S.	2.3	3516
ADSORBED GAS, TOXIC, FLAMMABLE, CORROSIVE, N.O.S.	2.3	3517
ADSORBED GAS, TOXIC, FLAMMABLE, N.O.S.	2.3	3514
ADSORBED GAS, TOXIC, N.O.S.	2.3	3512
ADSORBED GAS, TOXIC, OXIDIZING, CORROSIVE, N.O.S.	2.3	3518
ADSORBED GAS, TOXIC, OXIDIZING, N.O.S.	2.3	3515
Amphibole asbestos, see	9	2212
ARSINE, ADSORBED	2.3	3522
ASBESTOS, AMPHIBOLE	9	2212
ASBESTOS, CHRYSOTILE	9	2590
BORON TRIFLUORIDE, ADSORBED	2.3	3519
CAPACITOR, ASYMMETRIC, (with an energy storage capacity greater than 0.3Wh)	9	3508
CHLORINE, ADSORBED	2.3	3520
Chrysotile, see	9	2590
GERMANE, ADSORBED	2.3	3523
HYDROGEN SELENIDE, ADSORBED	2.3	3526

<i>Name and description</i>	<i>Class</i>	<i>UN No.</i>
Mercurous chloride, see	6.1	2025
PACKAGING DISCARDED, EMPTY, UNCLEANED	9	3509
PHOSPHINE, ADSORBED	2.3	3525
PHOSPHORUS PENTAFLUORIDE, ADSORBED	2.3	3524
SAFETY DEVICES, electrically initiated	9	3268
SAFETY DEVICES, PYROTECHNIC	1.4G	0503
SILICON TETRAFLUORIDE, ADSORBED	2.3	3521
URANIUM HEXAFLUORIDE, RADIOACTIVE MATERIAL, EXCEPTED PACKAGE, less than 0.1 kg per package, non- fissile or fissile-excepted	8	3507
Talcum with tremolite and/or actinolite, see	9	2212

#### PART 4 PACKING AND TANK PROVISIONS

#### Chapter 4.1 – Use of packagings, including intermediate bulk containers (IBCs) and large packagings

#### 4.1.1 General provisions for the packing of dangerous goods in packagings, including IBCs and large packagings

4.1.1.3 In paragraph 4.1.1.3, in the third line, the reference "6.3.2" is replaced with "6.3.5".

4.1.1.5.2 Insert a new 4.1.1.5.2 to read as follows:

"4.1.1.5.2 Use of supplementary packagings within an outer packaging (e.g. an intermediate packaging or a receptacle inside a required inner packaging) additional to what is required by the packing instructions is authorized provided all relevant requirements are met, including those of 4.1.1.3, and, if appropriate, suitable cushioning is used to prevent movement within the packaging."

and the remaining paragraphs are renumbered accordingly.

#### 4.1.4 List of packing instructions

##### 4.1.4.1 Packing instructions concerning the use of packagings (except IBCs and large packagings)

P001 Insert a new last sentence in subparagraph (a) of PP1 as follows

"On roll-on/roll-off ships the unit loads may be carried in vehicles other than closed vehicles provided they are securely fenced to the full height of the cargo carried;"

P003 Add a new special packing provision PP91 to read as follows:

"PP91 For UN 1044, large fire extinguishers may also be transported unpackaged provided that the requirements of 4.1.3.8.1.1 to 4.1.3.8.1.5 are met, the valves are protected by one of the methods in accordance with 4.1.6.1.8.1 to 4.1.6.1.8.4 and other equipment mounted on the fire extinguisher is protected to prevent accidental activation. For the purpose of this special packing provision, "large fire extinguishers" means fire extinguishers as described in subparagraphs .3 to .5 of special provision 225 of Chapter 3.3."

P114(a) Under Outer Packagings, Drums: Before "fibre (1G)" insert "plywood (1D)".

P116 In the column for "outer packagings", amend the first entry for "bags" to read: "woven plastics (5H1, 5H2, 5H3)". Amend special packing provision PP65 to read: "*Deleted*".

P131 and P137 In the entry for "boxes", in the column for "outer packagings" add: "plastics, solid (4H2)".

P404 (1) Amend to read as follows:

(1) **Combination packagings**  
**Outer packagings:** (1A1, 1A2, 1B1, 1B2, 1N1, 1N2, 1H1, 1H2, 1D, 1G, 4A, 4B, 4N, 4C1, 4C2, 4D, 4F, 4G or 4H2)  
**Inner packagings:** Metal receptacles with a maximum net mass of 15 kg each.  
 Inner packagings shall be hermetically sealed and have threaded closures;  
 Glass receptacles, with a maximum net mass of 1 kg each, having threaded closures with gaskets, cushioned on all sides and contained in hermetically sealed metal cans.  
 Outer packagings shall have a maximum net mass of 125 kg.

P501, P502 and P504 Amend the last entry under "Composite packaging" to read as follows:

"Glass receptacle in steel, aluminium, fibre or plywood drum (6PA1, 6PB1, 6PD1 or 6PG1) or in a steel, aluminium, wood or fibreboard box or in wickerwork hamper (6PA2, 6PB2, 6PC, 6PG2 or 6PD2) or in solid or expanded plastics packaging (6PH1 or 6PH2)."

P601 (2) and P602 (2) At the beginning, insert "or plastics" after "consisting of metal".

P650 Amend the diagram in paragraph (4) to read as follows:

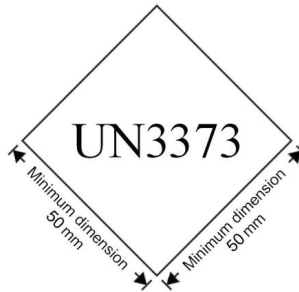

P802 (3) Amend to read as follows:

- "(3) Composite packagings: Glass receptacle in steel, aluminium or plywood drum (6PA1, 6PB1 or 6PD1) or in a steel, aluminium or wood box or in wickerwork hamper (6PA2, 6PB2, 6PC or 6PD2) or in solid plastics packaging (6PH2); maximum capacity: 60 litres."

P901 After "(see 3.3.1, special provision 251)", insert the following new sentence: "Where the kit contains only dangerous goods to which no packing group is assigned, packagings shall meet Packing Group II performance level."

P903 In paragraph (2), replace subparagraphs (a) and (b) with the following subparagraphs (a) to (c):

- "(a) Strong outer packagings;  
(b) Protective enclosures (e.g. fully enclosed or wooden slatted crates); or  
(c) Pallets or other handling devices."

P904 Amend the diagram to read as follows:



P906 (2) Amend to read as follows:

- "(2) For transformers and condensers and other devices:

- (a) Packagings in accordance with packing instructions P001 or P002. The articles shall be secured with suitable cushioning material to prevent inadvertent movement during normal conditions of transport; or
- (b) Leakproof packagings which are capable of containing, in addition to the devices, at least 1.25 times the volume of the liquid PCBs, polyhalogenated biphenyls or terphenyls present in them. There shall be sufficient absorbent material in the packagings to absorb at least 1.1 times the volume of liquid which is contained in the devices. In general, transformers and condensers shall be carried in leakproof metal packagings which are capable of holding, in addition to the transformers and condensers, at least 1.25 times the volume of the liquid present in them."

Insert the following new packing instructions:

P208	PACKING INSTRUCTION	P208
This instruction applies to Class 2 adsorbed gases.		
<p>(1) The following packagings are authorized provided the general packing requirements of 4.1.6.1 are met: Cylinders specified in Chapter 6.2 and in accordance with ISO 11513:2011 or ISO 9809-1:2010.</p> <p>(2) The pressure of each filled cylinder shall be less than 101.3 kPa at 20°C and less than 300 kPa at 50°C.</p> <p>(3) The minimum test pressure of the cylinder shall be 21 bar.</p> <p>(4) The minimum burst pressure of the cylinder shall be 94.5 bar.</p> <p>(5) The internal pressure at 65°C of the filled cylinder shall not exceed the test pressure of the cylinder.</p> <p>(6) The adsorbent material shall be compatible with the cylinder and shall not form harmful or dangerous compounds with the gas to be adsorbed. The gas in combination with the adsorbent material shall not affect or weaken the cylinder or cause a dangerous reaction (e.g. a catalyzing reaction).</p> <p>(7) The quality of the adsorbent material shall be verified at the time of each fill to assure the pressure and chemical stability requirements of this packing instruction are met each time an adsorbed gas package is offered for transport.</p> <p>(8) The adsorbent material shall not meet the criteria of any of the Classes or Divisions in this Code.</p> <p>(9) Requirements for cylinders and closures containing toxic gases with an LC<sub>50</sub> less than or equal to 200 ml/m<sup>3</sup> (ppm) (see table 1) shall be as follows:</p> <p>(a) Valve outlets shall be fitted with pressure retaining gas-tight plugs or caps having threads matching those of the valve outlets.</p> <p>(b) Each valve shall either be of the packless type with non-perforated diaphragm, or be of a type which prevents leakage through or past the packing.</p> <p>(c) Each cylinder and closure shall be tested for leakage after filling.</p> <p>(d) Each valve shall be capable of withstanding the test pressure of the cylinder and be directly connected to the cylinder by either a taper-thread or other means which meets the requirements of ISO 10692-2:2001.</p> <p>(e) Cylinders and valves shall not be fitted with a pressure relief device.</p> <p>(10) Valve outlets for cylinders containing pyrophoric gases shall be fitted with gas-tight plugs or caps having threads matching those of the valve outlets.</p> <p>(11) The filling procedure shall be in accordance with Annex A of ISO 11513:2011.</p> <p>(12) The maximum period for periodic inspections shall be 5 years.</p> <p>(13) Special packing provisions that are specific to a substance (see table 1).</p> <p><i>Material compatibility</i></p> <p>a: Aluminum alloy cylinders shall not be used.</p> <p>d: When steel cylinders are used, only those bearing the "H" mark in accordance with 6.2.2.7.4 (p) are permitted.</p> <p><i>Gas specific provisions</i></p> <p>r: The filling ratio of this gas shall be limited such that, if complete decomposition occurs, the pressure does not exceed two thirds of the test pressure of the cylinder.</p> <p><i>Material Compatibility for N.O.S Adsorbed Gas Entries</i></p> <p>z: The construction materials of the cylinders and their accessories shall be compatible with the contents and shall not react to form harmful or dangerous compounds therewith.</p>		

<b>P208</b>		<b>PACKING INSTRUCTION</b>				<b>P208</b>
Table 1: ADSORBED GASES						
UN No.	Name and description	Class or Division	Subsidiary risk	LC <sub>50</sub> , ml/m <sup>3</sup>	Special packing provisions	
(1)	(2)	(3)	(4)	(5)	(6)	
3510	ADSORBED GAS, FLAMMABLE, N.O.S.	2.1			z	
3511	ADSORBED GAS, N.O.S.	2.2			z	
3512	ADSORBED GAS, TOXIC, N.O.S.	2.3		≤ 5000	z	
3513	ADSORBED GAS, OXIDIZING, N.O.S.	2.2	5.1		z	
3514	ADSORBED GAS, TOXIC, FLAMMABLE, N.O.S.	2.3	2.1	≤ 5000	z	
3515	ADSORBED GAS, TOXIC, OXIDIZING, N.O.S.	2.3	5.1	≤ 5000	z	
3516	ADSORBED GAS, TOXIC, CORROSIVE, N.O.S.	2.3	8	≤ 5000	z	
3517	ADSORBED GAS, TOXIC, FLAMMABLE, CORROSIVE, N.O.S.	2.3	2.1 8	≤ 5000	z	
3518	ADSORBED GAS, TOXIC, OXIDIZING, CORROSIVE, N.O.S.	2.3	5.1 8	≤ 5000	z	
3519	BORON TRIFLUORIDE, ADSORBED	2.3	8	387	a	
3520	CHLORINE, ADSORBED	2.3	5.1 8	293	a	
3521	SILICON TETRAFLUORIDE, ADSORBED	2.3	8	450	a	
3522	ARSINE, ADSORBED	2.3	2.1	20	d	
3523	GERMANE, ADSORBED	2.3	2.1	620	d, r	
3524	PHOSPHORUS PENTAFLUORIDE, ADSORBED	2.3	8	190		
3525	PHOSPHINE, ADSORBED	2.3	2.1	20	d	
3526	HYDROGEN SELENIDE, ADSORBED	2.3	2.1	2		

P505		PACKING INSTRUCTION		P505
This instruction applies to UN No. 3375				
The following packagings are authorized, provided that the general provisions of 4.1.1 and 4.1.3 are met:				
<b>Combination packagings:</b>		<b>Inner packaging maximum capacity</b>	<b>Outer packaging maximum net mass</b>	
Boxes (4B, 4C1, 4C2, 4D, 4G, 4H2) or drums (1B2, 1G, 1N2, 1H2, 1D) jerricans (3B2, 3H2) with glass, plastics or metal inner packagings		5 l	125 kg	
<b>Single packagings:</b>		<b>Maximum capacity</b>		
<b>Drums</b>				
aluminium (1B1, 1B2),		250 l		
plastics (1H1, 1H2)		250 l		
<b>Jerricans</b>				
aluminium (3B1, 3B2),		60 l		
plastics (3H1, 3H2)		60 l		
<b>Composite packagings</b>				
plastics receptacle with outer aluminium drum (6HB1)		250 l		
plastics receptacle with outer fibre, plastics or plywood drum (6HG1, 6HH1, 6HD1)		250 l		
plastics receptacle with outer aluminium crate or box or plastics receptacle with outer wooden, plywood, fibreboard or solid plastics box (6HB2, 6HC, 6HD2, 6HG2, 6HH2)		60 l		
glass receptacle with outer aluminium, fibre or plywood drum (6PB1, 6PG1, 6PD1) or with outer expanded plastics or solid plastics receptacles (6PH1, 6PH2) or with outer aluminium crate or box or with outer wooden or fibreboard box or with outer wickerwork hamper (6PB2, 6PC, 6PG2, 6PD2)		60 l		

P805		PACKING INSTRUCTION		P805
This instruction applies to UN 3507.				
The following packagings are authorized provided that the general provisions of 4.1.1 and 4.1.3 and the special packing provisions of 4.1.9.1.2, 4.1.9.1.4 and 4.1.9.1.7 are met:				
Packagings consisting of:				
(a) Metal or plastics primary receptacle(s); in				
(b) Leakproof rigid secondary packaging(s); in				
(c) A rigid outer packaging:				
Drums (1A2, 1B2, 1N2, 1H2, 1D, 1G);				
Boxes (4A, 4B, 4C1, 4C2, 4D, 4F, 4G, 4H1, 4H2);				
Jerricans (3A2, 3B2, 3H2).				
<b>Additional requirements:</b>				
1. Primary inner receptacles shall be packed in secondary packagings in a way that, under normal conditions of transport, they cannot break, be punctured or leak their contents into the secondary packaging. Secondary packagings shall be secured in outer packagings with suitable cushioning material to prevent movement. If multiple primary receptacles are placed in a single secondary packaging, they shall be either individually wrapped or separated so as to prevent contact between them.				



P805	PACKING INSTRUCTION	P805
2.	The contents shall comply with the provisions of 2.7.2.4.5.2;	
3.	The provisions of 6.4.4 shall be met.	
<b>Special packing provision:</b>		
In the case of fissile-excepted material, limits specified in 2.7.2.3.5 and 6.4.11.2 shall be met.		

P908	PACKING INSTRUCTION	P908
This instruction applies to UN Nos. 3090, 3091, 3480 and 3481.		
The following packagings are authorized for damaged or defective lithium ion cells and batteries and lithium metal cells and batteries including those contained in equipment, provided the general provisions of 4.1.1 and 4.1.3 are met:		
For cells and batteries and equipment containing cells and batteries:		
Drums (1A2, 1B2, 1N2, 1H2, 1D, 1G)		
Boxes (4A, 4B, 4N, 4C1, 4C2, 4D, 4F, 4G, 4H1, 4H2)		
Jerricans (3A2, 3B2, 3H2)		
Packagings shall conform to the packing group II performance level.		
<ol style="list-style-type: none"> <li>1. Each cell or battery or equipment containing such cells or batteries shall be individually packed in inner packaging and placed inside of an outer packaging. The inner packaging or outer packaging shall be leak-proof to prevent the potential release of electrolyte.</li> <li>2. Each inner packaging shall be surrounded by sufficient non-combustible and non-conductive thermal insulation material to protect against a dangerous evolution of heat.</li> <li>3. Sealed packagings shall be fitted with a venting device when appropriate.</li> <li>4. Appropriate measures shall be taken to minimize the effects of vibrations and shocks, prevent movement of the cells or batteries within the package that may lead to further damage and a dangerous condition during transport. Cushioning material that is non-combustible and non-conductive may also be used to meet this requirement.</li> <li>5. Non combustibility shall be assessed according to a standard recognized in the country where the packaging is designed or manufactured.</li> </ol>		
For leaking cells or batteries, sufficient inert absorbent material shall be added to the inner or outer packaging to absorb any release of electrolyte.		
A cell or battery with a net mass of more than 30 kg shall be limited to one cell or battery per outer packaging.		
<b>Additional requirements:</b>		
Cells or batteries shall be protected against short circuit.		

P909	PACKING INSTRUCTION	P909
<p>This instruction applies to UN Nos. 3090, 3091, 3480 and 3481 transported for disposal or recycling, either packed together with or packed without non-lithium batteries:</p>		
<p>(1) Cells and batteries shall be packed in accordance with the following:</p> <p>(a) The following packagings are authorized, provided that the general provisions of 4.1.1 and 4.1.3, are met: Drums (1A2, 1B2, 1N2, 1H2, 1D, 1G); Boxes (4A, 4B, 4N, 4C1, 4C2, 4D, 4F, 4G, 4H2); and Jerricans (3A2, 3B2, 3H2).</p> <p>(b) Packagings shall conform to the packing group II performance level.</p> <p>(c) Metal packagings shall be fitted with a non-conductive lining material (e.g. plastics) of adequate strength for the intended use.</p> <p>(2) However, lithium ion cells with a Watt-hour rating of not more than 20 Wh, lithium ion batteries with a Watt-hour rating of not more than 100 Wh, lithium metal cells with a lithium content of not more than 1 g and lithium metal batteries with an aggregate lithium content of not more than 2 g may be packed in accordance with the following:</p> <p>(a) In strong outer packaging up to 30 kg gross mass meeting the general provisions of 4.1.1, except 4.1.1.3, and 4.1.3.</p> <p>(b) Metal packagings shall be fitted with a non-conductive lining material (e.g. plastics) of adequate strength for the intended use.</p> <p>(3) For cells or batteries contained in equipment, strong outer packagings constructed of suitable material, and of adequate strength and design in relation to the packaging capacity and its intended use, may be used. Packagings need not meet the requirements of 4.1.1.3. Large equipment may be offered for transport unpackaged or on pallets when the cells or batteries are afforded equivalent protection by the equipment in which they are contained.</p> <p>(4) In addition, for cells or batteries with a gross mass of 12 kg or more employing a strong, impact resistant outer casing, strong outer packagings constructed of suitable material and of adequate strength and design in relation to the packagings capacity and its intended use, may be used. Packagings need not meet the requirements of 4.1.1.3.</p>		
<p><b>Additional requirements:</b></p> <p>1. Cells and batteries shall be designed or packed to prevent short circuits and the dangerous evolution of heat.</p> <p>2. Protection against short circuits and the dangerous evolution of heat includes, but is not limited to: -individual protection of the battery terminals, -inner packaging to prevent contact between cells and batteries, -batteries with recessed terminals designed to protect against short circuits, or -the use of a non-conductive and non-combustible cushioning material to fill empty space between the cells or batteries in the packaging.</p> <p>3. Cells and batteries shall be secured within the outer packaging to prevent excessive movement during transport (e.g. by using a non-combustible and non-conductive cushioning material or through the use of a tightly closed plastics bag).</p>		

#### 4.1.4.2 Packing instructions concerning the use of IBCs

In IBC02, insert the following new special provision B16:

"B16 For UN 3375, IBCs of type 31A and 31N are not allowed without competent authority approval."

In IBC04, replace "and 21N" with ", 21N, 31A, 31B and 31N".

In IBC05 (1), replace "and 21N" with ", 21N, 31A, 31B and 31N".

In IBC05 (2), replace "and 21H2" with ", 21H2, 31H1 and 31H2".

In IBC05 (3), replace "and 21HZ1" with ", 21HZ1 and 31HZ1".

In IBC06 (1), IBC07 (1) and IBC08 (1), replace "and 21N" with ", 21N, 31A, 31B and 31N".

In IBC06 (2), IBC07 (2) and IBC08 (2), replace "and 21H2" with ", 21H2, 31H1 and 31H2".

In IBC06 (3), IBC07 (3) and IBC08 (3), replace "and 21HZ2" with "21HZ2 and 31HZ1".

IBC100, in the first line of packing instruction IBC100, insert "0222" after "0082". Insert the following special packing provisions:

"B2 For UN No. 0222 in IBCs other than metal or rigid plastics IBCs, the IBCs shall be transported in closed cargo transport units."

"B3 For UN No. 0222, flexible IBCs shall be sift-proof and water resistant or shall be fitted with a sift-proof and water resistant liner."

"B17 For UN No. 0222, metal IBCs are not authorized."

#### 4.1.4.3 Special packing instructions concerning the use of large packagings

Insert the following new packing instructions:

LP903	PACKING INSTRUCTION	LP903
This instruction applies to UN Nos. 3090, 3091, 3480 and 3481		
<p>The following large packagings are authorized for a single battery, including for a battery contained in equipment, provided that the general provisions of 4.1.1 and 4.1.3 are met:</p> <p>Rigid large packagings conforming to the packing group II performance level, made of:</p> <ul style="list-style-type: none"> <li>steel (50A);</li> <li>aluminium (50B);</li> <li>metal other than steel or aluminium (50N);</li> <li>rigid plastics (50H);</li> <li>natural wood (50C);</li> <li>plywood (50D);</li> <li>reconstituted wood (50F);</li> <li>rigid fibreboard (50G).</li> </ul> <p>The battery shall be packed so that the battery is protected against damage that may be caused by its movement or placement within the large packaging.</p>		
<p><b>Additional requirement:</b> Batteries shall be protected against short circuit.</p>		

LP904	PACKING INSTRUCTION	LP904
This instruction applies to UN Nos. 3090, 3091, 3480 and 3481		
<p>The following large packagings are authorized for a single damaged or defective battery and for a single damaged or defective battery contained in equipment, provided the general provisions of 4.1.1 and 4.1.3 are met</p> <p>For batteries and equipment containing batteries:</p> <ul style="list-style-type: none"><li>steel (50A)</li><li>aluminium (50B)</li><li>metal other than steel or aluminium (50N)</li><li>rigid plastics (50H)</li><li>plywood (50D)</li></ul> <p>Packagings shall conform to the packing group II performance level.</p> <ol style="list-style-type: none"><li>1. Each battery or equipment containing such battery shall be individually packed in an inner packaging and placed inside of an outer packaging. The inner packaging or outer packaging shall be leak-proof to prevent the potential release of electrolyte.</li><li>2. Each inner packaging shall be surrounded by sufficient non-combustible and non-conductive thermal insulation material to protect against a dangerous evolution of heat.</li><li>3. Sealed packagings shall be fitted with a venting device when appropriate.</li><li>4. Appropriate measures shall be taken to minimize the effects of vibrations and shocks, prevent movement of the battery within the package that may lead to further damage and a dangerous condition during transport. Cushioning material that is non-combustible and non-conductive may also be used to meet this requirement.</li><li>5. Non combustibility shall be assessed according to a standard recognized in the country where the packaging is designed or manufactured.</li></ol> <p>For leaking batteries, sufficient inert absorbent material shall be added to the inner or outer packaging to absorb any release of electrolyte.</p>		
<b>Additional requirements:</b>		
Batteries shall be protected against short circuit.		

#### 4.1.6 Special packing provisions for goods of class 2

##### 4.1.6.1 General provisions

4.1.6.1.2 Replace "ISO 11114-1:1997" with "ISO 11114-1:2012".

#### 4.1.9 Special packing provisions for class 7

##### 4.1.9.1 General

4.1.9 Amend the title to read "Special packing provisions for radioactive material"

4.1.9.1.3 Delete ", other than an excepted package,".

4.1.9.1.6 Amend the introductory sentence to read as follows:

"Before a packaging is first used to transport radioactive material, it shall be confirmed that it has been manufactured in conformity with the design specifications to ensure compliance with the relevant provisions of is Code and any applicable certificate of approval. The following requirements shall also be fulfilled, if applicable:".

In subparagraph .1, replace "package" with "packaging".

In subparagraph .2, amend the beginning of the sentence to read as follows:

"For each packaging intended for use as a Type B(U), Type B(M) or Type C package and for each packaging intended to contain fissile material ...".

In subparagraph.3, amend the text to read as follows:

".3 For each packaging intended to contain fissile material, it shall be ensured that the effectiveness of the criticality safety features is within the limits applicable to or specified for the design and in particular where, in order to comply with the requirements of 6.4.11.1 neutron poisons are specifically included, checks shall be performed to confirm the presence and distribution of those neutron poisons."

4.1.9.1.7 Insert a new paragraph to read as follows:

"4.1.9.1.7 Before each shipment of any package, it shall be ensured that the package contains neither:

- .1 Radionuclides different from those specified for the package design; nor
- .2 Contents in a form, or physical or chemical state different from those specified for the package design."

Current paragraphs 4.1.9.1.7 to 4.1.9.1.11 become new paragraphs 4.1.9.1.8 to 4.1.9.1.12.

4.1.9.1.8 (former 4.1.9.1.7) Amend to read as follows:

"4.1.9.1.8 Before each shipment of any package, it shall be ensured that all the requirements specified in the relevant provisions of this Code and in the applicable certificates of approval have been fulfilled. The following requirements shall also be fulfilled, if applicable:

- .1 It shall be ensured that lifting attachments which do not meet the requirements of 6.4.2.2 have been removed or otherwise rendered incapable of being used for lifting the package, in accordance with 6.4.2.3;
- .2 Each Type B(U), Type B(M) and Type C package shall be held until equilibrium conditions have been approached closely enough to demonstrate compliance with the requirements for temperature and pressure unless an exemption from these requirements has received unilateral approval;
- .3 For each Type B(U), Type B(M) and Type C package, it shall be ensured by inspection and/or appropriate tests that all closures, valves and other openings of the containment system through which the radioactive contents might escape are properly closed and, where appropriate, sealed in the manner for which the demonstrations of compliance with the requirements of 6.4.8.8 and 6.4.10.3 were made;

- .4 For packages containing fissile material the measurement specified in 6.4.11.5 (b) and the tests to demonstrate closure of each package as specified in 6.4.11.8 shall be performed."

#### 4.1.9.2 Provisions and controls for transport of LSA material and SCO

- 4.1.9.2.2 Amend to read as follows:

"4.1.9.2.2 For LSA material and SCO which are or contain fissile material, which is not excepted under 2.7.2.3.5, the applicable requirements of 7.1.4.5.15 and 7.1.4.5.16 shall be met."

- 4.1.9.2.3 Insert a new paragraph 4.1.9.2.3 to read as follows:

"4.1.9.2.3 For LSA material and SCO which are or contain fissile material, the applicable requirements of 6.4.11.1 shall be met."

and current paragraphs 4.1.9.2.3 and 4.1.9.2.4 become new paragraphs 4.1.9.2.4 and 4.1.9.2.5 respectively. Table 4.1.9.2.4 is renumbered as 4.1.9.2.5.

- 4.1.9.2.4 (former 4.1.9.2.3) In .2, delete "and" at the end.

Add a new subparagraph .4 to read as follows:

".4 Unpackaged fissile material shall meet the requirements of 2.7.2.3.5.5"

- 4.1.9.2.5 (former 4.1.9.2.4) Replace "4.1.9.2.3" with "4.1.9.2.4" and "table 4.1.9.2.4" with "table 4.1.9.2.5".

Table 4.1.9.2.5 In note "a" under the table replace "4.1.9.2.3" with "4.1.9.2.4".

- 4.1.9.3 Packages containing fissile material

- 4.1.9.3 Amend to read as follows:

"4.1.9.3 The contents of packages containing fissile material shall be as specified for the package design either directly in the provisions of this Code or in the certificate of approval."

### Chapter 4.2 – Use of portable tanks and multiple-element gas containers (MEGCs)

#### 4.2.5 Portable tank instructions and special provisions

##### 4.2.5.2.6 Portable tank instructions

- 4.2.5.2.6 Amend the header to the tabulated portable tank instructions for T1 – T22 to read as follows:

"These portable tank instructions apply to liquid and solid substances of Class 1 and Classes 3 to 9. The general provisions of section 4.2.1 and the requirements of section 6.7.2 shall be met."

- 4.2.5.2.6 In tank instruction T23, at the end of footnote § add: ""CORROSIVE" subsidiary risk placard required (Model No 8, see 5.2.2.2)."

4.2.5.3 Portable tank special provisions

4.2.5.3 In special provision TP32, paragraph (b), at the beginning, insert "For UN 3375 only,".

4.2.5.3 Add the following new portable tank special provision:

"TP41 The 2.5 year internal examination may be waived or substituted by other test methods or inspection procedures specified by the competent authority or its authorized body, provided that the portable tank is dedicated to the transport of the organometallic substances to which this tank special provision is assigned. However this examination is required when the conditions of 6.7.2.19.7 are met."

## PART 5 CONSIGNMENT PROCEDURES

### Chapter 5.1 – General provisions

#### 5.1.2 Use of overpacks and unit loads

5.1.2.1 Add the following new sentence and note at the end:

"The lettering of the "OVERPACK" marking shall be at least 12 mm high.

**Note:** The size requirement for the "OVERPACK" marking shall apply as from 1 January 2016."

#### 5.1.3 Empty uncleaned packagings or units

5.1.3.2 Replace "Packagings, including IBCs, and tanks" with "Freight containers, tanks, IBCs, as well as other packagings and overpacks,".

#### 5.1.5 General provisions for class 7

##### 5.1.5.1 Approval of shipments and notification

###### 5.1.5.1.1 *General*

5.1.5.1.1 In the first sentence replace "for package designs" with "of package designs".

###### 5.1.5.1.2 *Shipment approvals*

5.1.5.1.2 In subparagraph .4 replace "according to" with "in accordance with".

###### 5.1.5.1.4 *Notifications*

5.1.5.1.4 In subparagraph .3 replace "for shipment approval" with "for approval of shipment (see 6.4.23.2)".

5.1.5.2 Certificates issued by competent authority

5.1.5.2.1 In .1, insert a new subparagraph .3 to read as follows:

"3 fissile material excepted under 2.7.2.3.5.6;"

and consequently, current subparagraphs .3 to .6 are renumbered as .4 to .7.

5.1.5.2.1 In subparagraph .5 (former .4) delete "all" and "replace "6.4.11.2" with "2.7.2.3.5, 6.4.11.2 or 6.4.11.3".

5.1.5.2.1 Insert new .4 and .5 to read as follows:

"4 Determination of the basic radionuclide values referred to in 2.7.2.2.1 for individual radionuclides which are not listed in table 2.7.2.2.1 (see 2.7.2.2.2 .1);

.5 Alternative activity limits for an exempt consignment of instruments or articles (see 2.7.2.2.2.2);

5.1.5.2.1 Amend the second paragraph after subparagraphs .1 to .5 to read as follows:

"The certificates of approval for the package design and the shipment may be combined into a single certificate."

5.1.5.2.3 In the first sentence, amend the beginning of the sentence to read:

"For package designs where it is not required that a competent authority issue a certificate of approval, the consignor ..."

5.1.5.3 Determination of transport index (TI) and criticality safety index (CSI)

5.1.5.3.4 In the first sentence, replace "and overpacks" with ", overpacks and freight containers".

In subparagraph .1, replace (twice) "or overpack" with ", overpack or freight container".

In subparagraph.5, insert "or freight container" after "overpack".

In the table in 5.1.5.3.4, replace "and overpacks" with ", overpacks and freight containers" and in note "b" to the table insert at end "except for freight containers (see table 7.1.4.5.3)".

5.1.5.3.5 Replace "design or shipment approval" with "approval of design or shipment".

5.1.5.4 Specific provisions for excepted packages

5.1.5.4 Amend the title to read "Specific provisions for excepted packages of radioactive material of Class 7".

5.1.5.4.1 After "excepted packages", insert "of radioactive material of Class 7".



5.1.5.4.2 Amend to read as follows:

"5.1.5.4.2 The documentation requirements of Chapter 5.4 do not apply to excepted packages of radioactive material of Class 7, except that:

- .1 The UN number preceded by the letters "UN" and the name and address of the consignor and the consignee and, if relevant, the identification mark for each competent authority certificate of approval (see 5.4.1.5.7.1 7.) shall be shown on a transport document such as a bill of lading, air waybill or other similar document complying with the requirements of 5.4.1.2.1 to 5.4.1.2.4;
- .2 The requirements of 5.4.1.6.2 and, if relevant, those of 5.4.1.5.7.1.7, 5.4.1.5.7.3 and 5.4.1.5.7.4 shall apply;
- .3 The requirements of 5.4.2 and 5.4.4 shall apply."

5.1.5.4.3 Insert a new paragraph to read as follows:

"5.1.5.4.3 The requirements of 5.2.1.5.8 and 5.2.2.1.12.5 shall apply if relevant."

**5.1.5.5 Specific provisions for the consignment of fissile material**

Insert a new section 5.1.5.5 as follows:

**"5.1.5.5 Specific provisions for the consignment of fissile material**

Fissile material meeting one of the provisions of 2.7.2.3.5.1 to 2.7.2.3.5.6 shall meet the following requirements:

- .1 Only one of the provisions of 2.7.2.3.5.1 to 2.7.2.3.5.6 is allowed per consignment;
- .2 Only one approved fissile material in packages classified in accordance with 2.7.2.3.5.6 is allowed per consignment unless multiple materials are authorized in the certificate of approval;
- .3 Fissile material in packages classified in accordance with 2.7.2.3.5.3 shall be transported in a consignment with no more than 45 g of fissile nuclides;
- .4 Fissile material in packages classified in accordance with 2.7.2.3.5.4 shall be transported in a consignment with no more than 15 g of fissile nuclides;
- .5 Unpackaged or packaged fissile material classified in accordance with 2.7.2.3.5.5 shall be transported under exclusive use on a conveyance with no more than 45 g of fissile nuclides."

---

## Chapter 5.2 – Marking and labelling of packages including IBCs

### 5.2.1 Marking of packages including IBCs

#### 5.2.1.1 Amend the second sentence to read as follows:

"The UN number and the letters "UN" shall be at least 12 mm high, except for packages of 30 litres capacity or less or of 30 kg maximum net mass and for cylinders of 60 litres water capacity when they shall be at least 6 mm in height and except for packages of 5 litres or 5 kg or less when they shall be of an appropriate size."

#### 5.2.1.3 Add the following new sentence and note at the end:

"The lettering of the "SALVAGE" marking shall be at least 12 mm high.

**NOTE:** The size requirement for the "SALVAGE" marking shall apply as from 1 January 2016."

#### 5.2.1.5 Special marking provisions for class 7

#### 5.2.1.5 Replace "for Class 7" with "for radioactive material".

#### 5.2.1.5.1 Insert the following sentence at the end:

"Each overpack shall be legibly and durably marked on the outside of the overpack with an identification of either the consignor or consignee, or both unless these markings of all packages within the overpack are clearly visible."

#### 5.2.1.5.2 After "excepted packages" insert "of radioactive material of Class 7".

#### 5.2.1.5.5 Amend the introductory sentence to read as follows:

"Each package which conforms to a design approved under one or more of paragraphs 5.1.5.2.1, 6.4.22.1 to 6.4.22.4, 6.4.23.4 to 6.4.23.7 and 6.4.24.2 shall be legibly and durably marked on the outside of the package with the following information:"

#### 5.2.1.5.5 Amend .3 to read as follows:

".3 "Type B(U)", "Type B(M)" or "Type C", in the case of a Type B(U), Type B(M) or Type C package design"

#### 5.2.1.5.5 Delete subparagraph 4.

#### 5.2.1.5.7 Replace "4.1.9.2.3" with "4.1.9.2.4".

#### 5.2.1.5.8 Replace "competent authority design or shipment approval" with "competent authority approval of design or shipment".

#### 5.2.1.6 Special marking provisions for marine pollutants

#### 5.2.1.6.1 Replace existing paragraph with the following:

"5.2.1.6.1 "Except as provided in 2.10.2.7, packages containing marine pollutants meeting the criteria of 2.9.3 shall be durably marked with the marine pollutant mark."

5.2.1.6.3 Amend 5.2.1.6.3 and figure to read as follows:

"5.2.1.6.3 The marine pollutant mark shall be as shown in the figure below.



Marine Pollutant Mark

The marking shall be in the form of a square set at an angle of 45° (diamond-shaped). The symbol (fish and tree) shall be black on white or suitable contrasting background. The minimum dimensions shall be 100 mm x 100 mm and the minimum width of line forming the diamond shall be 2 mm. If the size of the package so requires, the dimensions/line thickness may be reduced, provided the marking remains clearly visible. Where dimensions are not specified, all features shall be in approximate proportion to those shown.

**NOTE 1:** The labelling provisions of 5.2.2 apply in addition to any requirement for packages to bear the marine pollutant mark.

**NOTE 2:** The provisions of 5.2.1.6.3 of IMDG Code (Amendment 36-12) may continue to be applied until 31 December 2016."

5.2.1.7 Amend the figures and caption below to read as follows:

"

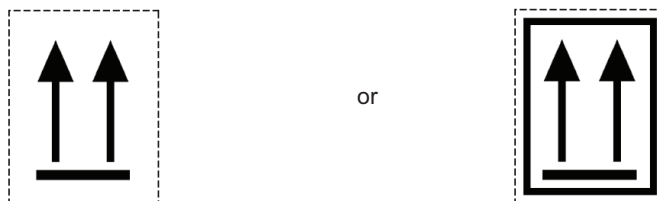

Two black or red arrows on white or suitable contrasting background.

The rectangular border is optional

All features shall be in approximate proportion to those shown."

## 5.2.2 Labelling of packages including IBCs

### 5.2.2.1 Labelling provisions

#### 5.2.2.1.12 Special provisions for the labelling of radioactive material

5.2.2.1.12.1 Amend the first and second sentences to read as follows:

"Except when enlarged labels are used in accordance with 5.3.1.1.5.1, each package, overpack and freight container containing radioactive material shall bear the labels conforming to the applicable models Nos. 7A, 7B or 7C, according to the appropriate category. Labels shall be affixed to two opposite sides on the outside of the package or overpack or on the outside of all four sides of a freight container or tank."

5.2.2.1.12.1 In the fourth sentence amend "under 6.4.11.2" read "under the provisions of 2.7.2.3.5", replace "which conform to model" with "conforming to model"; replace the last phrase of the fourth sentence with the following:

"such labels, where applicable shall be affixed adjacent to the labels conforming to the applicable model Nos. 7A, 7B or 7C."

5.2.2.1.12.2 In the introductory sentence, replace "Nos. 7A, 7B and 7C" with "the applicable model No. 7A, 7B or 7C".

5.2.2.1.12.2 In .2, amend the last sentence to read as follows:

"For fissile material, the total mass of fissile nuclides in units of grams (g), or multiples thereof, may be used in place of activity".

5.2.2.1.12.3 Amend to read as follows:

"5.2.2.1.12.3 Each label conforming to the model No. 7E shall be completed with the criticality safety index (CSI) as stated in the certificate of approval applicable in the countries through or into which the consignment is transported and issued by the competent authority or as specified in 6.4.11.2 or 6.4.11.3."

5.2.2.1.12.4 Amend to read as follows:

"5.2.2.1.12.4 For overpacks and freight containers, the label conforming to model No. 7E shall bear the sum of the criticality safety indexes of all the packages contained therein".

5.2.2.1.12.5 Replace "competent authority design or shipment approval" with "competent authority approval of design or shipment".

### 5.2.2.2 Provisions for labels

5.2.2.2.1 Amend to read as follows:

"5.2.2.2.1.1 Labels shall be configured as shown in the figure below:

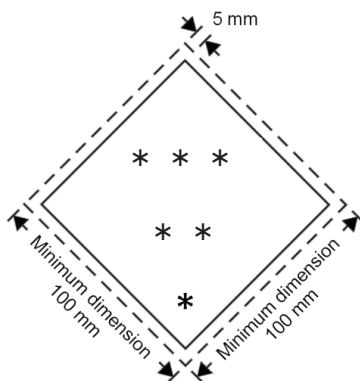

Class/division label

- \* The class or, for divisions 5.1 and 5.2, the Division number shall be shown in the bottom corner
- \*\* Additional text/numbers/letters shall (if mandatory) or may (if optional) be shown in this bottom half
- \*\*\* The class or division symbol or, for divisions 1.4, 1.5 and 1.6, the division number and for Model No 7E the word "FISSILE" shall be shown in this top half".

5.2.2.2.1.1.1 Labels shall be displayed on a background of contrasting colour, or shall have either a dotted or solid outer boundary line.

5.2.2.2.1.1.2 The label shall be in the form of a square set at an angle of 45° (diamond-shaped). The minimum dimensions shall be 100 mm x 100 mm and the minimum width of the line inside the edge forming the diamond shall be 2 mm. The line inside the edge shall be parallel and 5 mm from the outside of that line to the edge of the label. The line inside the edge on the upper half of the label shall be the same colour as the symbol and the line inside the edge on the lower half of the label shall be the same colour as the class or division number in the bottom corner. Where dimensions are not specified, all features shall be in approximate proportion to those shown.

5.2.2.2.1.1.3 If the size of the package so requires the dimensions may be reduced, provided the symbols and other elements of the label remain clearly visible. The line inside the edge shall remain 5 mm to the edge of the label. The minimum width of the line inside the edge shall remain 2 mm. Dimensions for cylinders shall comply with 5.2.2.2.1.2.

**NOTE:** The provisions of 5.2.2.2.1.1 of the IMDG Code (Amendment 36-12) may continue to be applied until 31 December 2016. When so applied, 5.2.2.2.1.1.1, 5.2.2.2.1.1.2 and 5.2.2.2.1.1.3 shall not apply until 31 December 2016."

#### 5.2.2.2.2 Specimen Labels

5.2.2.2.2 Insert a new "note" under the heading as follows:

**"Note:** Labels shall satisfy the provisions below and conform, in terms of colour, symbols and general format, to the models shown in 5.2.2.2.2. Corresponding models required for other modes of transport, with minor variations which do not affect the obvious meaning of the label, are also acceptable."

The following symbols within the IMDG Code, should be replaced by those used by the UN Recommendations:

Class 2.1, Class 2.3, No. 3, No. 4, Class 4.3, Class 5.1, Class 5.2, Class 6 and Class 8.

### Chapter 5.3 – Placarding and marking of cargo transport units

#### 5.3.1 Placarding

##### 5.3.1.1 Placarding provisions

##### 5.3.1.1.4 *Placarding requirements*

5.3.1.1.4.1 Replace the existing subparagraph ".1" with the following:

".1 a freight container, semi-trailer or portable tank: one on each side and one on each end of the unit. Portable tanks having a capacity of less than 3,000 litres may be placarded or, alternatively, may be labeled instead, on only two opposite sides."

##### 5.3.1.1.5 *Special provisions for class 7*

5.3.1.1.5.1 Amend the last sentence to read as follows:

"Instead of using both labels and placards, it is permitted as an alternative to use enlarged labels only, as shown in label models Nos. 7A, 7B and 7C, except having the minimum size shown in figure 5.3.1."

5.3.1.1.5.2 In the introductory sentence replace "No." with "Nos.", "or 7E" with "and 7E" and "(Model 7D)" with "(model No.7D)".

##### 5.3.1.2 Specifications for placards

5.3.1.2.1 Amend to read as follows:

"5.3.1.2.1 Except as provided in 5.3.1.2.2 for the Class 7 placard, and in 5.3.2.3.2 for the marine pollutant mark, a placard shall be configured as shown in the figure below.

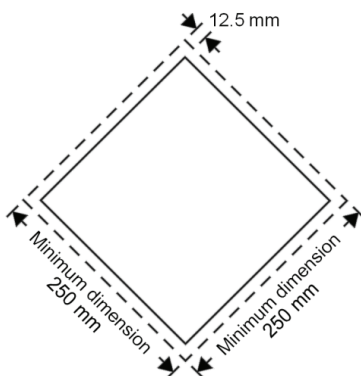

Placard (except for class 7)

The placard shall be in the form of a square set at an angle of 45° (diamond-shaped). The minimum dimensions shall be 250 mm x 250 mm (to the edge of the placard). The line inside the edge shall be parallel and 12.5 mm from the outside of that line to the edge of the placard. The symbol and line inside the edge shall correspond in colour to the label for the class or division of the dangerous goods in question. The class or division symbol/numeral shall be positioned and sized in proportion to those prescribed in 5.2.2.2 for the corresponding class or division of the dangerous goods in question. The placard shall display the number of the class or division (and for goods in Class 1, the compatibility group letter) of the dangerous goods in question in the manner prescribed in 5.2.2.2 for the corresponding label, in digits not less than 25 mm high. Where dimensions are not specified, all features shall be in approximate proportion to those shown.

**NOTE:** The provisions of 5.3.1.2.1 from the IMDG Code (amendment 36-12) may continue to be applied until 31 December 2016."

### 5.3.2 Marking of cargo transport units

5.3.2.0.2 Insert a new second new sentence as follows:

"This may be reduced to 12 mm for portable tank containers with a capacity of less than 3,000 litres."

#### 5.3.2.2 Elevated temperature substances

5.3.2.2.1 Amend to read as follows:

"5.3.2.2.1 Cargo transport units containing a substance that is transported or offered for transport in a liquid state at a temperature equal to or exceeding 100°C, in a solid state at a temperature equal to or exceeding 240°C shall bear on each side and on each end the mark shown in the figure below.

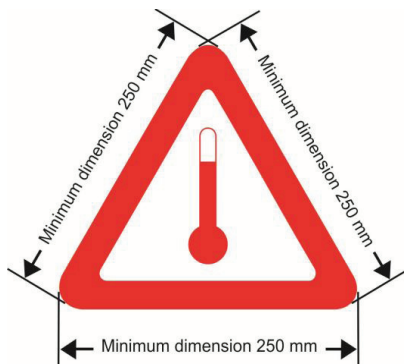

Mark for transport at elevated temperature

The marking shall be an equilateral triangle. The colour of the mark shall be red. The minimum dimension of the sides shall be 250 mm except for portable tanks with a capacity of less than 3,000 litres where the sides may be reduced to 100 mm. Where dimensions are not specified, all features shall be in approximate proportion to those shown.

**Note:** The provisions of 5.3.2.2 of the IMDG Code (Amendment 36-12) may continue to be applied until 31 December 2016."

### 5.3.2.3 Marine pollutant mark

5.3.2.3 Replace existing paragraph under 5.3.2.3 with the following:

"5.3.2.3.1 Except as provided in 2.10.2.7, cargo transport units containing marine pollutants shall clearly display the marine pollutant mark in locations indicated in 5.3.1.1.4.1"

5.3.2.3.2 The marine pollutant mark for cargo transport units shall be as described in 5.2.1.6.3, except that the minimum dimensions shall be 250 mm x 250 mm. For portable tanks with a capacity of less than 3,000 litres, the dimensions may be reduced to 100 mm x 100 mm."

## Chapter 5.4 – Documentation

### 5.4.1 Dangerous goods transport information

#### 5.4.1.4.3 Information which supplements the Proper Shipping Name in the dangerous goods description

5.4.1.4.3 Replace existing subparagraph ".5" with the following:

".5 Marine pollutants: Except as provided in 2.10.2.7, if the goods to be transported are marine pollutants, the goods shall be identified as "MARINE POLLUTANT", and for generic or "not otherwise specified" (N.O.S.) entries the Proper Shipping Name shall be supplemented with



the recognized chemical name of the marine pollutant (see 3.1.2.9). The term "MARINE POLLUTANT" may be supplemented with the term "ENVIRONMENTALLY HAZARDOUS";

5.4.1.5 Information required in addition to the dangerous goods description

5.4.1.5.7 *Radioactive material*

5.4.1.5.7.1 Amend subparagraph .6 to read as follows:

".6 For fissile material:

- (i) Shipped under one exception of 2.7.2.3.5.1 to 2.7.2.3.5.6, reference to that paragraph;
- (ii) Shipped under 2.7.2.3.5.1 to 2.7.2.3.5.5, the total mass of fissile nuclides;
- (iii) Contained in a package for which one of 6.4.11.2 (a) to (c) or 6.4.11.3 is applied, reference to that paragraph;
- (iv) The criticality safety index, where applicable."

5.4.1.5.7.1 In subparagraph .7, replace "competent authority approval certificate" with "competent authority certificate of approval" and insert "fissile material excepted under 2.7.2.3.5.6," before "special arrangement".

5.4.1.5.7.3 Replace "competent authorities design or shipment approval" with "competent authority approval of design or shipment".

5.4.1.6 Certification

5.4.1.6.1 In the text of the certification, after "above", insert "/ below\*\*".

and insert the following footnote:

\*\* as appropriate".

**5.4.1.5.12 Transport of solid dangerous goods in bulk containers**

5.4.1.5.12 At the end replace the sentence "Bulk container BK2 approved by the competent authority of ..." with the following:

"Bulk container BK(x) approved by the competent authority of ...".

and at the end insert the following note:

**Note:** "(x)" shall be replaced with "1" or "2", as appropriate.

#### 5.4.2 Container/vehicle packing certificate

5.4.2.1.8 Amend to read as follows:

- ".8 When substances presenting a risk of asphyxiation are used for cooling or conditioning purposes (such as dry ice (UN 1845) or nitrogen, refrigerated liquid (UN 1977) or argon, refrigerated liquid (UN 1951)), the container/vehicle is externally marked in accordance with 5.5.3.6; and".

#### 5.4.3 Documentation required aboard the ship

5.4.3.1 The footnote reference in the paragraph "\* FAL.2/Circ.52/Rev.1 may be used for this purpose" is replaced with "Resolution FAL. 10(35), adopted on 16 January 2009, amendments to the annex to the convention on facilitation of international maritime traffic, 1965".

### Chapter 5.5 – Special provisions

#### 5.5.2.3 Marking and placarding

Amend 5.5.2.3.2 as follows:

"5.5.2.3.2 The fumigation warning mark shall be as shown in the figure below.

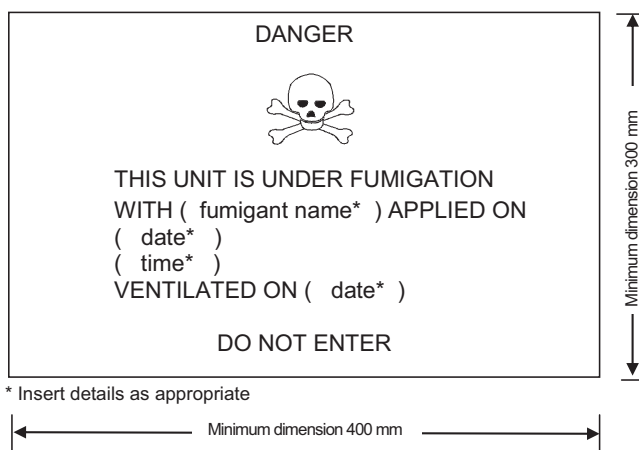

Fumigation warning mark

The marking shall be a rectangle. The minimum dimensions shall be 400 mm wide x 300 mm high and the minimum width of the outer line shall be 2 mm. The marking shall be in black print on a white background with lettering not less than 25 mm high. Where dimensions are not specified, all features shall be in approximate proportion to those shown.

**Note:** The provisions of 5.5.2.3.2 of the IMDG Code (Amendment 36-12) may continue to be applied until 31 December 2016."

**5.5.3 Special provisions applicable to packages and cargo transport units containing substances presenting a risk of asphyxiation when used for cooling or conditioning purposes (such as dry ice (UN 1845) or nitrogen, refrigerated liquid (UN 1977) or argon, refrigerated liquid (UN 1951))**

**5.5.3.1 Scope**

5.5.3 Add a new subparagraph 5.5.3.1.4 to read as follows:

"5.5.3.1.4 Cargo transport units containing substances used for cooling or conditioning purposes include cargo transport units containing substances used for cooling or conditioning purposes inside packages as well as cargo transport units with unpackaged substances used for cooling or conditioning purposes."

**5.5.3.2 General**

5.5.3.2.2 Amend the first sentence as follows:

"5.5.3.2.2 When dangerous goods are loaded in cargo transport units containing substances used for cooling or conditioning purposes any provisions of these Regulations relevant to these dangerous goods apply in addition to the provisions of this section."

5.5.3.2.4 Amend to read as follows:

"5.5.3.2.4 Persons engaged in the handling or transport of cargo transport units containing substances used for cooling or conditioning purposes shall be trained commensurate with their responsibilities."

**5.5.3.6 Marking of cargo transport units**

5.5.3.6.1 Add "purposes" after "cooling or conditioning" in the first sentence.

5.5.3.6.2 Amend paragraph to read as follows:

"5.5.3.6.2 The warning mark shall be as shown in the figure below

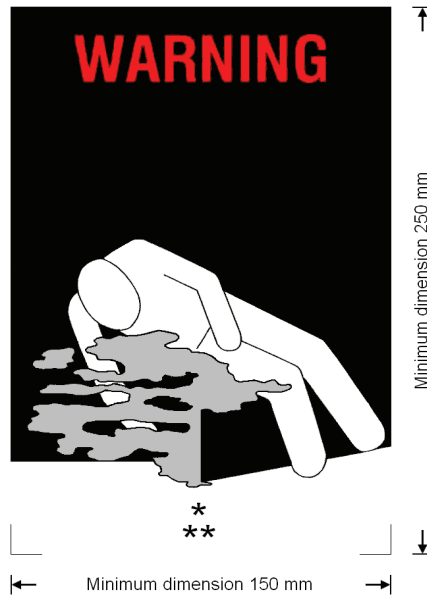

Coolant/conditioning warning mark for cargo transport units

- \* Insert proper shipping name of the coolant/conditioner. The lettering shall be in capitals, all be on one line and shall be at least 25 mm high. If the length of the proper shipping name is too long to fit in the space provided, the lettering may be reduced to the maximum size possible to fit. For example: CARBON DIOXIDE, SOLID.
- \*\* Insert "AS COOLANT" or "AS CONDITIONER" as appropriate. The lettering shall be in capitals, all be on one line and be at least 25 mm high.

The marking shall be a rectangle. The minimum dimensions shall be 150 mm wide x 250 mm high. The word "WARNING" shall be in red or white and be at least 25 mm high. Where dimensions are not specified, all features shall be in approximate proportion to those shown.

**NOTE:** The provisions of 5.5.3.6.2 of the IMDG Code (Amendment 36-12) may continue to be applied until 31 December 2016."

### 5.5.3.7 Documentation

5.5.3.7.1 Replace "that have been cooled or conditioned" with "containing or have contained substances used for cooling or conditioning purposes".

**PART 6**  
**CONSTRUCTION AND TESTING OF PACKAGINGS, INTERMEDIATE BULK**  
**CONTAINERS (IBCs), LARGE PACKAGINGS, PORTABLE TANKS,**  
**MULTIPLE-ELEMENT GAS CONTAINERS (MEGCs)**  
**AND ROAD TANK VEHICLES**

**Chapter 6.1 – Provisions for the construction and testing of packagings (other than for class 6.2 substances)**

**6.1.1 Applicability and general provisions**

**6.1.1.1 Applicability**

6.1.1.1.4 Amend to read "Packagings for liquids, other than combination packagings, with capacity exceeding 450 L".

**6.1.3 Marking**

6.1.3.1(e) Insert a reference to note "\*" at the centre of the symbol and add the following note under the symbol:

"\* The last two digits of the year of manufacture may be displayed at that place. In such a case, the two digits of the year in the type approval marking and in the inner circle of the clock shall be identical."

and insert a new Note at the end to read as follows:

"NOTE: Other methods that provide the minimum required information in a durable, visible and legible form are also acceptable."

**Chapter 6.2 – Provisions for the construction and testing of pressure receptacles, aerosol dispensers, small receptacles containing gas (gas cartridges) and fuel cell cartridges containing liquefied flammable gas**

**6.2.1 General provisions**

**6.2.1.1 Design and construction**

6.2.1.1.5 Add the following new last sentence:

"The test pressure of a cylinder for an adsorbed gas shall be in accordance with packing instruction P208."

**6.2.2 Provisions for UN pressure receptacles**

6.2.2 Add the following new second sentence:

"Manufacture of new pressure receptacles or service equipment according to any particular standard in 6.2.2.1 and 6.2.2.3 is not permitted after the date shown in the right hand column of the tables."

Renumber the existing NOTE as "NOTE 1".

Add the following new note:

**"NOTE 2:** UN pressure receptacles and service equipment constructed according to standards applicable at the date of manufacture may continue in use subject to the periodic inspection provisions of this Code."

### 6.2.2.1 Design, construction and initial inspection and test

6.2.2.1.1 In the table, add a new third column. Add a new first row with the following text:

Reference	Title	Applicable for manufacture
-----------	-------	----------------------------

For ISO Standards "ISO 9809-1:1999", "ISO 9809-2:2000" and "ISO 9809-3:2000", in the third column, add "Until 31 December 2018".

After ISO Standard "ISO 9809-1:1999" add the following new standard:

ISO 9809-1:2010	Gas cylinders -- Refillable seamless steel gas cylinders -- Design, construction and testing -- Part 1: Quenched and tempered steel cylinders with tensile strength less than 1 100 MPa	Until further notice
-----------------	---	----------------------

After ISO Standard "ISO 9809-2:2000" add the following new standard:

ISO 9809-2:2010	Gas cylinders -- Refillable seamless steel gas cylinders -- Design, construction and testing -- Part 2: Quenched and tempered steel cylinders with tensile strength greater than or equal to 1 100 MPa	Until further notice
-----------------	--	----------------------

After ISO Standard "ISO 9809-3:2000" add the following new standard:

ISO 9809-3:2010	Gas cylinders -- Refillable seamless steel gas cylinders -- Design, construction and testing -- Part 3: Normalized steel cylinders	Until further notice
-----------------	--	----------------------

For all the other standards, in the column "Applicable for manufacture", add "Until further notice".

6.2.2.1.2 In the table, add a new third column. Add a new first row with the following text:

Reference	Title	Applicable for manufacture
-----------	-------	----------------------------

For ISO Standard "ISO 11120:1999", in the column "Applicable for manufacture", add "Until further notice".

6.2.2.1.3 Amend the first table to read as follows:

Reference	Title	Applicable for manufacture
ISO 9809-1:1999	Gas cylinders – Refillable seamless steel gas cylinders – Design, construction and testing – Part 1: Quenched and tempered steel cylinders with tensile strength less than 1 100 MPa <i>NOTE: The note concerning the F factor in section 7.3 of this standard shall not be applied for UN cylinders.</i>	Until 31 December 2018
ISO 9809-1:2010	Gas cylinders – Refillable seamless steel gas cylinders – Design, construction and testing – Part 1: Quenched and tempered steel cylinders with tensile strength less than 1 100 MPa	Until further notice
ISO 9809-3:2000	Gas cylinders – Refillable seamless steel gas cylinders – Design, construction and testing – Part 3: Normalized steel cylinders	Until 31 December 2018
ISO 9809-3:2010	Gas cylinders – Refillable seamless steel gas cylinders – Design, construction and testing – Part 3: Normalized steel cylinders	Until further notice

6.2.2.1.3 (second table), 6.2.2.1.4 and 6.2.2.1.5 In the tables, add a new third column. Add a new first row with the following text:

Reference	Title	Applicable for manufacture
-----------	-------	----------------------------

For all the standards, in the column "Applicable for manufacture", add "Until further notice".

6.2.2.1.6 After 6.2.2.1.5 insert the following new paragraphs:

"6.2.2.1.6 The standard shown below applies for the design, construction and initial inspection and test of UN bundles of cylinders. Each cylinder in a UN bundle of cylinders shall be a UN cylinder complying with the requirements of 6.2.2. The inspection requirements related to the conformity assessment system and approval for UN bundles of cylinders shall be in accordance with 6.2.2.5.

Reference	Title	Applicable for manufacture
ISO 10961:2010	Gas cylinders – Cylinder bundles – Design, manufacture, testing and inspection	Until further notice

**NOTE:** Changing one or more cylinders of the same design type, including the same test pressure, in an existing UN bundle of cylinders does not require re-certification of the existing bundle."

"6.2.2.1.7 The following standards apply for the design, construction and initial inspection and test of UN cylinders for adsorbed gases except that the inspection requirements related to the conformity assessment system and approval shall be in accordance with 6.2.2.5.

Reference	Title	Applicable for manufacture
ISO 11513:2011	Gas cylinders – Refillable welded steel cylinders containing materials for sub-atmospheric gas packaging (excluding acetylene) – Design, construction, testing, use and periodic inspection	Until further notice
ISO 9809-1:2010	Gas cylinders – Refillable seamless steel gas cylinders – Design, construction and testing – Part 1: Quenched and tempered steel cylinders with tensile strength less than 1 100 MPa	Until further notice

”.

### 6.2.2.2 Materials

6.2.2.2 Replace "ISO 11114-1:1997" with "ISO 11114-1:2012". In the title for standard "ISO 11114-1:2012", delete "Transportable". Delete the note at the end.

### 6.2.2.3 Service equipment

6.2.2.3 Amend the first table to read as follows:

Reference	Title	Applicable for manufacture
ISO 11117:1998	Gas cylinders – Valve protection caps and valve guards for industrial and medical gas cylinders – Design, construction and tests	Until 31 December 2014
ISO 11117:2008 + Cor 1:2009	Gas cylinders – Valve protection caps and valve guards – Design, construction and tests	Until further notice
ISO 10297:1999	Gas cylinders – Refillable gas cylinder valves – Specification and type testing	Until 31 December 2008
ISO 10297:2006	Gas cylinders – Refillable gas cylinder valves – Specification and type testing	Until further notice
ISO 13340:2001	Transportable gas cylinders – Cylinders valves for non-refillable cylinders – Specification and prototype testing	Until further notice

6.2.2.3 In the second table, add a new third column. Add a new first row with the following text:

Reference	Title	Applicable for manufacture
-----------	-------	----------------------------

For ISO Standard "ISO 16111:2008", in the column "Applicable for manufacture", add "Until further notice".

6.2.2.4 In the table, add a new third column. Add a new first row with the following text:

Reference	Title	Applicable
-----------	-------	------------

For all standards, in the column "Applicable", add "Until further notice".

### 6.2.2.4 Periodic inspection and test

6.2.2.4 In the table of standards for periodic inspection and test, after the entry for "ISO 10462:2005" add the following new entry:



ISO 11513:2011	Gas cylinders – Refillable welded steel cylinders containing materials for sub-atmospheric gas packaging (excluding acetylene) – Design, construction, testing, use and periodic inspection	Until further notice
-------------------	---	----------------------

### 6.2.2.7 Marking of refillable UN pressure receptacles

6.2.2.7 Amend the note to read as follows:

**"Note:** Marking requirements for UN metal hydride storage systems are given in 6.2.2.9 and marking requirements for UN bundles of cylinders are given in 6.2.2.10."

6.2.2.7.4 In subparagraph (p) replace "ISO 11114-1:1997" with "ISO 11114-1:2012".

6.2.2.7.9 Is deleted.

### 6.2.2.9 Marking of UN metal hydride storage systems

6.2.2.9.2 In subparagraph (j) replace "ISO 11114-1:1997" with "ISO 11114-1:2012".

### 6.2.2.10 Marking of bundles of cylinders

Add the following new section:

#### **"6.2.2.10 Marking of bundles of cylinders**

6.2.2.10.1 Individual cylinders in a bundle of cylinders shall be marked in accordance with 6.2.2.7.

6.2.2.10.2 Refillable UN bundles of cylinders shall be marked clearly and legibly with certification, operational, and manufacturing marks. These marks shall be permanently affixed (e.g. stamped, engraved, or etched) on a plate permanently attached to the frame of the bundle of cylinders. Except for the UN packaging symbol, the minimum size of the marks shall be 5 mm. The minimum size of the UN packaging symbol shall be 10 mm.

6.2.2.10.3 The following marks shall be applied:

- (a) The certification marks specified in 6.2.2.7.2 (a), (b), (c), (d) and (e);
- (b) The operational marks specified in 6.2.2.7.3 (f), (i), (j) and the total of the mass of the frame of the bundle and all permanently attached parts (cylinders, manifold, fittings and valves). Bundles intended for the carriage of UN 1001 acetylene, dissolved and UN 3374 acetylene, solvent free shall bear the tare mass as specified in clause B.4.2 of ISO 10961:2010; and
- (c) The manufacturing marks specified in 6.2.2.7.4 (n), (o) and, where applicable, (p).

6.2.2.10.4 The marks shall be placed in three groups:

- (a) The manufacturing marks shall be the top grouping and shall appear consecutively in the sequence given in 6.2.2.10.3 (c);
- (b) The operational marks in 6.2.2.10.3 (b) shall be the middle grouping and the operational mark specified in 6.2.2.7.3 (f) shall be immediately preceded by the operational mark specified in 6.2.2.7.3 (i) when the latter is required;
- (c) Certification marks shall be the bottom grouping and shall appear in the sequence given in 6.2.2.10.3 (a)."

#### **6.2.4 Provisions for aerosol dispensers, small receptacles containing gas (gas cartridges) and fuel cell cartridges containing liquefied flammable gas**

6.2.4 In the heading, delete the word "flammable". Insert the following text after the heading:

"Each filled aerosol dispenser or gas cartridge or fuel cell cartridge shall be subjected to a test in a hot water bath in accordance with 6.2.4.1 or an approved water bath alternative in accordance with 6.2.4.2."

##### **6.2.4.1 Small receptacles containing gas (gas cartridges) and fuel cell cartridges containing liquefied flammable gas**

Delete 6.2.4.1, 6.2.4.1.1 and 6.2.4.1.2, heading 6.2.4.2 and the text under this heading.

Renumber heading 6.2.4.2.1 as 6.2.4.1.

##### **6.2.4.2 Aerosol dispensers**

###### *6.2.4.2.1 Hot water bath test*

6.2.4.2.1.1 Renumber as 6.2.4.1.1. In the first sentence, after "capacity of the aerosol dispenser" insert ", gas cartridge or fuel cell cartridge". In the second sentence, after "to heat or if aerosol dispensers" insert "gas cartridges or fuel cell cartridges" and after "one aerosol dispenser," insert "gas cartridge or fuel cell cartridge".

6.2.4.2.1.2 Renumber as 6.2.4.1.2. After the first "aerosol dispenser" insert ", receptacle or fuel cell cartridge". After the second "aerosol dispenser" insert ", gas cartridge or fuel cell cartridge".

Renumber heading 6.2.4.2.2 as 6.2.4.2 and, in the text under this heading, replace "of 6.2.4.2.2.1, 6.2.4.2.2.2 and 6.2.4.2.2.3" by "of 6.2.4.2.1 and, as appropriate, 6.2.4.2.2 or 6.2.4.2.3".

###### *6.2.4.2.2 Alternative methods*

6.2.4.2.2.1 Renumber as 6.2.4.2.1. In the first sentence, after "Aerosol dispenser" insert ", gas cartridge or fuel cell cartridge". In the second sentence, after "that all aerosol dispensers" insert ", gas cartridges or fuel cell cartridges" In indent (f) insert the following text at the end ", gas cartridges or fuel cell cartridges".

Before 6.2.4.2.2.2, insert the following text "6.2.4.2.2 Aerosol dispensers".

6.2.4.2.2.2 *Pressure and leak testing of aerosol dispensers before filling*

6.2.4.2.2.2 Renumber as 6.2.4.2.2.1. Replace "Every" with "Each" at the beginning of the first sentence.

6.2.4.2.2.3 *Testing of the aerosol dispensers after filling*

6.2.4.2.2.3 Renumber as 6.2.4.2.2.2.

Add a new 6.2.4.2.3 to read as follows:

"6.2.4.2.3 Gas cartridges and fuel cell cartridges

6.2.4.2.3.1 Pressure testing of gas cartridges and fuel cell cartridges

Each gas cartridge or fuel cell cartridge shall be subjected to a test pressure equal to or in excess of the maximum expected in the filled receptacle at 55°C (50°C if the liquid phase does not exceed 95% of the capacity of the receptacle at 50°C). This test pressure shall be that specified for the gas cartridge or fuel cell cartridge and shall not be less than two thirds the design pressure of the gas cartridge or fuel cell cartridge. If any gas cartridge or fuel cell cartridge shows evidence of leakage at a rate equal to or greater than  $3.3 \times 10^{-2}$  mbar.l.s<sup>-1</sup> at the test pressure or distortion or any other defect, it shall be rejected.

6.2.4.2.3.2 Leak testing gas cartridges and fuel cell cartridges

Prior to filling and sealing, the filler shall ensure that the closures (if any), and the associated sealing equipment are closed appropriately and the specified gas is used.

Each filled gas cartridge or fuel cell cartridge shall be checked for the correct mass of gas and shall be leak tested. The leak detection equipment shall be sufficiently sensitive to detect at least a leak rate of  $2.0 \times 10^{-3}$  mbar.l.s<sup>-1</sup> at 20°C.

Any gas cartridge or fuel cell cartridge that has gas masses not in conformity with the declared mass limits or shows evidence of leakage or deformation, shall be rejected."

**Chapter 6.4 – Provisions for the construction, testing and approval of packages and material of class 7**

In the title, replace "class 7" with "radioactive material".

**6.4.2 General provisions**

6.4.2.11 Insert a new paragraph 6.4.2.11 to read as follows:

"6.4.2.11 A package shall be so designed that it provides sufficient shielding to ensure that, under routine conditions of transport and with the maximum radioactive contents that the package is designed to contain, the radiation level at any point on the external surface of the package would not exceed the values specified in 2.7.2.4.1.2, 4.1.9.1.10 and 4.1.9.1.11, as applicable, with account taken of 7.1.4.5.3.3 and 7.1.4.5.5".

---

Current paragraphs 6.4.2.11 and 6.4.2.12 become 6.4.2.12 and 6.4.2.13 respectively.

#### **6.4.3 Additional provisions for packages transported by air**

6.4.3.3 Replace "leakage" with "loss or dispersal of radioactive contents from the containment system,".

#### **6.4.6 Provisions for packages containing uranium hexafluoride**

6.4.6.1 Amend the first sentence to read as follows:

"Packages designed to contain uranium hexafluoride shall meet the requirements which pertain to the radioactive and fissile properties of the material prescribed elsewhere in this Code."

6.4.6.2 In subparagraphs .1 and .3, insert at the end: "except as allowed in 6.4.6.4".

6.4.6.4 In the introductory sentence replace "the approval of the competent authority" with "multilateral approval" and insert "the packages are designed:" at the end, after "if".

and in subparagraphs (a) and (b) delete "the packages are designed" and replace "and" with "and/or" at the end. In subparagraph (c), delete "for packaged designed" and replace "hexafluoride, the packages" with "hexafluoride and the packages".

#### **6.4.8 Provisions for Type B(U) packages**

6.4.8.1 Amend to read as follows:

"6.4.8.1 Type B(U) packages shall be designed to meet the requirements specified in 6.4.2, the requirements specified in 6.4.3 if carried by air, and of 6.4.7.2 to 6.4.7.15, except as specified in 6.4.7.14 (a), and, in addition, the requirements specified in 6.4.8.2 to 6.4.8.15."

6.4.8.2 Amend the end of the introductory paragraph to read: "...which may cause one or more of the following:". And in (a) and (b), delete "or" at the end.

6.4.8.8 In subparagraph (b), replace "and the tests in" with "and either the test in."

#### **6.4.9 Provisions for Type B(M) packages**

6.4.9.1 In the first sentence, replace "6.4.8.4, 6.4.8.5 and 6.4.8.6," with "6.4.8.4 to 6.4.8.6". And in the second sentence, insert "6.4.8.4 and" after "packages specified in".

#### **6.4.10 Provisions for Type C packages**

6.4.10.3 Amend to read as follows:

"6.4.10.3 A package shall be so designed that, if it were at the maximum normal operating pressure and subjected to:

- (a) The tests specified in 6.4.15, it would restrict the loss of radioactive contents to not more than  $10^{-6}$  A<sub>2</sub> per hour; and
- (b) The test sequences in 6.4.20.1,

- (i) it would retain sufficient shielding to ensure that the radiation level at 1 m from the surface of the package would not exceed 10 mSv/h with the maximum radioactive contents which the package is designed to contain; and
- (ii) it would restrict the accumulated loss of radioactive contents in a period of 1 week to not more than 10 A<sub>2</sub> for krypton-85 and not more than A<sub>2</sub> for all other radionuclides."

The text of last paragraph remains unchanged.

#### 6.4.11 Provisions for packages containing fissile material

6.4.11.1 In (a), insert "routine," before "normal".

6.4.11.1 Amend (b)(i) to read as follows: "of 6.4.7.2 except for unpackaged material when specifically allowed by 2.7.2.3.5.5;"

6.4.11.1 In (b)(ii) delete "and" at the end.

6.4.11.1 Amend (b)(iii) to read as follows: "of 6.4.7.3 unless the material is excepted by 2.7.2.3.5;"

6.4.11.1 Insert a new (b) (iv) to read as follows:

"(iv) of 6.4.11.4 to 6.4.11.14, unless the material is excepted by 2.7.2.3.5, 6.4.11.2 or 6.4.11.3."

6.4.11.2 Amend to read as follows:

"6.4.11.2 Packages containing fissile material that meet the provisions of subparagraph (d) and one of the provisions of (a) to (c) below are excepted from the requirements of 6.4.11.4 to 6.4.11.14.

(a) Packages containing fissile material in any form provided that:

- (i) The smallest external dimension of the package is not less than 10 cm;
- (ii) The criticality safety index of the package is calculated using the following formula:

$$CSI = 50 \times 5 \times \left( \frac{\text{Mass of U-235 in package (g)}}{Z} + \frac{\text{Mass of other fissile nuclides * in package (g)}}{280} \right)$$

\* Plutonium may be of any isotopic composition provided that the amount of Pu-241 is less than that of Pu-240 in the package

where the values of Z are taken from table 6.4.11.2.

- (iii) The CSI of any package does not exceed 10;

(b) Packages containing fissile material in any form provided that:

- (i) The smallest external dimension of the package is not less than 30 cm;
- (ii) The package, after being subjected to the tests specified in 6.4.15.1 to 6.4.15.6;
  - Retains its fissile material contents;
  - Preserves the minimum overall outside dimensions of the package to at least 30 cm;
  - Prevents the entry of a 10 cm cube.
- (iii) The criticality safety index of the package is calculated using the following formula:

$$CSI = 50 \times 2 \times \left( \frac{\text{Mass of U-235 in package (g)}}{Z} + \frac{\text{Mass of other fissile nuclides * in package (g)}}{280} \right)$$

- \* Plutonium may be of any isotopic composition provided that the amount of Pu-241 is less than that of Pu-240 in the package.

where the values of Z are taken from table 6.4.11.2.

- (iv) The criticality safety index of any package does not exceed 10;
- (c) Packages containing fissile material in any form provided that:
- (i) The smallest external dimension of the package is not less than 10 cm;
  - (ii) The package, after being subjected to the tests specified in 6.4.15.1 to 6.4.15.6;
    - Retains its fissile material contents;
    - Preserves the minimum overall outside dimensions of the package to at least 10 cm;
    - Prevents the entry of a 10 cm cube.
  - (iii) The CSI of the package is calculated using the following formula:

$$CSI = 50 \times 2 \times \left( \frac{\text{Mass of U-235 in package (g)}}{450} + \frac{\text{Mass of other fissile nuclides * in package (g)}}{280} \right)$$

- \* Plutonium may be of any isotopic composition provided that the amount of Pu-241 is less than that of Pu-240 in the package.

- (iv) The maximum mass of fissile nuclides in any package does not exceed 15 g;

- (d) The total mass of beryllium, hydrogenous material enriched in deuterium, graphite and other allotropic forms of carbon in an individual package shall not be greater than the mass of fissile nuclides in the package except where their total concentration does not exceed 1 g in any 1,000 g of material. Beryllium incorporated in copper alloys up to 4% in weight of the alloy does not need to be considered."

Table 6.4.11.2 Insert a new table 6.4.11.2 to read as follows:

"Table 6.4.11.2 Values of Z for calculation of criticality safety index in accordance with 6.4.11.2

<i>Enrichement<sup>a</sup></i>	<i>Z</i>
Uranium enriched up to 1.5%	2200
Uranium enriched up to 5%	850
Uranium enriched up to 10%	660
Uranium enriched up to 20%	580
Uranium enriched up to 100%	450

<sup>a</sup> *If a package contains uranium with varying enrichments of U-235, then the value corresponding to the highest enrichment shall be used for Z.*

"

6.4.11.3 Insert a new paragraph 6.4.11.3 to read as follows:

"6.4.11.3 Packages containing not more than 1 000 g of plutonium are excepted from the application of 6.4.11.4 to 6.4.11.14 provided that:

- (a) Not more than 20% of the plutonium by mass is fissile nuclides;
- (b) The criticality safety index of the package is calculated using the following formula:

$$CSI = 50 \times 2 \times \frac{\text{mass of plutonium (g)}}{1000}$$

- (c) If uranium is present with the plutonium, the mass of uranium shall be no more than 1% of the mass of the plutonium."

Current paragraphs 6.4.11.3 to 6.4.11.13 become new paragraphs 6.4.11.4 to 6.4.11.14.

6.4.11.4 (former 6.4.11.3) Replace "6.4.11.7 to 6.4.11.12" with "6.4.11.8 to 6.4.11.13".

6.4.11.5 (former 6.4.11.4) Replace "6.4.11.7 to 6.4.11.12" with "6.4.11.8 to 6.4.11.13" and insert "either" at the end of the introductory sentence.

6.4.11.8 (former 6.4.11.7), in the last sentence of the introductory paragraph, insert "either of" before "the following:" and in subparagraph (a) and (b) (i), replace "6.4.11.12 (b)" with "6.4.11.13 (b)".

6.4.11.9 (former 6.4.11.8), in the last sentence replace "6.4.11.12 (b)" with "6.4.11.13 (b)" and "6.4.11.9 (c)" with "6.4.11.10 (c)".

6.4.11.10 (former 6.4.11.9) In the introductory sentence replace "6.4.11.7 and 6.4.11.8" with "6.4.11.8 and 6.4.11.9".

6.4.11.10 (former 6.4.11.9) In subparagraph (b), replace "6.4.11.11 (b)" with "6.4.11.12 (b)". In (c), replace "6.4.11.12 (b)" with "6.4.11.13 (b)".

6.4.11.11 (former 6.4.11.10) In subparagraph (b), replace "6.4.11.9" with "6.4.11.10" and "6.4.11.7" with "6.4.11.8".

6.4.11.13 (former 6.4.11.12) In subparagraph (c), replace "6.4.11.12 (b)" with "6.4.11.13(b)".

6.4.11.14 (former 6.4.11.13) Replace "6.4.11.11 and 6.4.11.12" with "6.4.11.12 and 6.4.11.13".

#### **6.4.13 Testing the integrity of the containment system and shielding and evaluating criticality safety**

6.4.13 In subparagraph (c) replace "6.4.11.13" with "6.4.11.14".

#### **6.4.15 Test for demonstrating ability to withstand normal conditions of transport**

6.4.15.5 In subparagraph (a), amend the beginning to read: "The equivalent of 5 times ...".

#### **6.4.17 Tests for demonstrating ability to withstand accident conditions of transport**

6.4.17.2 In the introductory paragraph, replace "6.4.11.12" with "6.4.11.13".

6.4.17.2 In subparagraph (b), move the phrase "so as to suffer maximum damage" to the end of the sentence after "on the target".

6.4.17.2 In subparagraph (c), insert the following new third sentence: "The lower face of the steel plate shall have its edges and corners rounded off to a radius of not more than 6 mm."

#### **6.4.19 Water leakage test for packages containing fissile material**

6.4.19.1 Replace "6.4.11.7 to 6.4.11.12" with "6.4.11.8 to 6.4.11.13".

6.4.19.2 Replace "6.4.11.12" with "6.4.11.13".

#### **6.4.20 Tests for Type C packages**

6.4.20.2 In the first sentence, insert "vertical" before "solid". In the second sentence replace "the probe to the surface of the specimen shall be as to cause" with "the package specimen and the impact point on the package surface shall be such as to cause".



#### **6.4.22 Approvals of package designs and materials**

6.4.22.4 Amend to read as follows:

"6.4.22.4 Each package design for fissile material which is not excepted by any of the paragraphs 2.7.2.3.5.1 to 2.7.2.3.5.6, 6.4.11.2 and 6.4.11.3 shall require multilateral approval."

6.4.22.6 Insert a new paragraph 6.4.22.6 to read as follows:

"6.4.22.6 The design for a fissile material excepted from "FISSILE" classification in accordance with 2.7.2.3.5.6 shall require multilateral approval."

6.4.22.7 Insert a new paragraph to read as follows:

"6.4.22.7 Alternative activity limits for an exempt consignment of instruments or articles in accordance with 2.7.2.2.2.2 shall require multilateral approval."

#### **6.4.23 Applications for approval and approvals for radioactive material transport**

6.4.23.2 In the introductory sentence replace "shipment approval" with "approval of shipment".

In subparagraph .3, amend the end of the paragraph to read as follows:

"... referred to in the certificate of approval for the package design, if applicable, issued under 5.1.5.2.1.1.3, 5.1.5.2.1.1.6 or 5.1.5.2.1.1.7, are to be put into effect."

6.4.23.4 In (f), insert "nuclear" after "irradiated" and replace "6.4.11.4 (b)" with "6.4.11.5 (b)". In (i), replace "quality assurance programme" with "management system" and "1.1.2.3.1" with "1.5.3.1".

6.4.23.5 In the introductory sentence, delete "for package approval".

in subparagraph (a), replace "6.4.8.4, 6.4.8.5, 6.4.8.6" with "6.4.8.4 to 6.4.8.6".

and in subparagraph (d), amend the beginning of the sentence to read: "a statement of the range".

6.4.23.6 Replace "quality assurance programme" with "management system".

6.4.23.7 Replace "quality assurance programme" with "management system".

6.4.23.8 In subparagraph (d) replace "quality assurance programme" with "management system".

6.4.23.9 Insert a new paragraph to read as follows:

"6.4.23.9 An application for approval of design for fissile material excepted from "FISSILE" classification in accordance with table 2.7.2.1.1, under 2.7.2.3.5.6 shall include:

- (a) A detailed description of the material; particular reference shall be made to both physical and chemical states;

- (b) A statement of the tests that have been carried out and their results, or evidence based on calculation methods to show that the material is capable of meeting the requirements specified in 2.7.2.3.6;
- (c) A specification of the applicable management system as required in 1.5.3.1;
- (d) A statement of specific actions to be taken prior to shipment."

6.4.23.10 Insert a new paragraph to read as follows:

"6.4.23.10 An application for approval of alternative activity limits for an exempt consignment of instruments or articles shall include:

- (a) An identification and detailed description of the instrument or article, its intended uses and the radionuclide(s) incorporated;
- (b) The maximum activity of the radionuclide(s) in the instrument or article;
- (c) Maximum external radiation levels arising from the instrument or article;
- (d) The chemical and physical forms of the radionuclide(s) contained in the instrument or article;
- (e) Details of the construction and design of the instrument or article, particularly as related to the containment and shielding of the radionuclide in routine, normal and accident conditions of transport;
- (f) The applicable management system, including the quality testing and verification procedures to be applied to radioactive sources, components and finished products to ensure that the maximum specified activity of radioactive material or the maximum radiation levels specified for the instrument or article are not exceeded, and that the instruments or articles are constructed according to the design specifications;
- (g) The maximum number of instruments or articles expected to be shipped per consignment and annually;
- (h) Dose assessments in accordance with the principles and methodologies set out in the International Basic Safety Standards for Protection against Ionizing Radiation and for the Safety of Radiation Sources, Safety Series No.115, IAEA, Vienna (1996), including individual doses to transport workers and members of the public and, if appropriate, collective doses arising from routine, normal and accident conditions of transport, based on representative transport scenarios the consignments are subject to."

Current paragraphs 6.4.23.9 to 6.4.23.11 become new paragraphs 6.4.23.11 to 6.4.23.13.

6.4.23.11 (former 6.4.23.9), in the introductory sentence, replace "approval certificate" with "certificate of approval".

6.4.23.11 (former 6.4.23.9) (a), replace "6.4.23.10 (b)" with "6.4.23.12 (b)".

6.4.23.11 (former 6.4.23.9) (b) Insert "or alternative activity limit for exempt consignment" at the end of the first sentence. Amend the second sentence to read: "The identification mark of the approval of shipment shall be clearly related to the identification mark of the approval of design."

6.4.23.11 (former 6.4.23.9) (c) In the introductory sentence, replace "types of approval certificates" with "types of certificate of approval". Insert the following line between those corresponding to LD and T: "FE Fissile material complying with the requirements of 2.7.2.3.6". Add the following line at the end of the list: "AL Alternative activity limits for an exempt consignment of instruments or articles".

6.4.23.11 (former 6.4.23.9) (d) Insert "certificates of approval of" before "package design", delete (twice) "approval certificates" after "radioactive material", and replace "6.4.24.2 to 6.4.24.4" with "6.4.24.2 to 6.4.24.5".

6.4.23.12 (former 6.4.23.10) In the introductory sentence replace "type codes" with "identification marks".

6.4.23.12 (former 6.4.23.10) (a) Replace "6.4.23.9 (a), (b), (c) and (d)" with "6.4.23.11 (a), (b), (c) and (d)"; "design approval" with "approval of design", and "shipment approval" with "the approval of shipment".

6.4.23.12 (former 6.4.23.10) (a) For A/132/B(M)F-96, replace "package design approval certificate" with "certificate of approval for the package design".

6.4.23.12 (former 6.4.23.10) (a) For A/132/B(M)F-96T, replace "shipment approval" with "approval of shipment".

6.4.23.12 (former 6.4.23.10) (a) For A/137/X, replace "a special arrangement approval" with "an approval of special arrangement".

6.4.23.12 (former 6.4.23.10) (a) For A/139/IF-96 and A/145/H(U)-96, replace "package design approval certificate" with "certificate of approval for the package design".

6.4.23.12 (former 6.4.23.10) (b) Replace "according to 6.4.23.16" with "in accordance with 6.4.23.20".

6.4.23.12 (former 6.4.23.10) (c) Replace (twice) "package design approval certificate" with "certificate of approval for the package design"; and "approval certificate" with "certificate of approval" in the last sentence.

6.4.23.13 (former 6.4.23.11) In the introductory sentence replace "approval certificate" with "certificate of approval" and in (i) replace "quality assurance programme" with "management system".

6.4.23.14 Insert a new paragraph to read as follows:

"6.4.23.14 Each certificate of approval issued by a competent authority for material excepted from classification as "FISSILE" shall include the following information:

- (a) Type of certificate;
- (b) The competent authority identification mark;
- (c) The issue date and an expiry date;
- (d) List of applicable national and international regulations, including the edition of the IAEA Regulations for the Safe Transport of Radioactive Material under which the exception is approved;
- (e) A description of the excepted material;
- (f) Limiting specifications for the excepted material;
- (g) A specification of the applicable management system as required in 1.5.3.1;
- (h) Reference to information provided by the applicant relating to specific actions to be taken prior to shipment;
- (i) If deemed appropriate by the competent authority, reference to the identity of the applicant;
- (j) Signature and identification of the certifying official;
- (k) Reference to documentation that demonstrates compliance with 2.7.2.3.6."

Current paragraphs 6.4.23.12 to 6.4.23.14 become new paragraphs 6.4.23.15 to 6.4.23.17.

6.4.23.15 (former 6.4.23.12), in the introductory sentence replace "approval certificate" with "certificate of approval".

6.4.23.15 (former 6.4.23.12) (j), replace "amounts" with "mass" and amend the end of the paragraph to read as follows: "... special form radioactive material, low dispersible radioactive material or fissile material excepted under 2.7.2.3.5.6 if applicable;"

6.4.23.15 (former 6.4.23.12) (k)(v), replace "6.4.11.4 (b)" with "6.4.11.5(b)".

6.4.23.15 (former 6.4.23.12) (r), replace "quality assurance programme" with "management system".

6.4.23.16 (former 6.4.23.13), in the introductory sentence, replace "approval certificate" with "certificate of approval".

6.4.23.16 (former 6.4.23.13) (i), replace "design approval certificate(s)" with "certificate(s) of approval of design".

6.4.23.16 (former 6.4.23.13) (g), replace "amounts" with "mass" and amend the end of the paragraph to read as follows: "...special form radioactive material, low dispersible radioactive material or fissile material excepted under 2.7.2.3.5.6 if applicable;".

6.4.23.16 (former 6.4.23.13) (l), replace "quality assurance programme" with "management system".

6.4.23.17 (former 6.4.23.14), in the introductory sentence, replace "approval certificate" with "certificate of approval".

6.4.23.17 (former 6.4.23.14) (h), replace "shipment approval" with "approval of shipment".

6.4.23.17 (former 6.4.23.14) (l), amend the end of the second sentence to read as follows: "... mass in grams (for fissile material the total mass of fissile nuclides or the mass for each fissile nuclide, when appropriate) and whether special form radioactive material, low dispersible radioactive material or fissile material excepted under 2.7.2.3.5.6, if applicable;".

6.4.23.17 (former 6.4.23.14) (n), amend the introductory sentence to read as follows: "For package designs containing fissile material which require multilateral approval of the package design in accordance with 6.4.22.4:".

6.4.23.17 (former 6.4.23.14) (n)(vi), replace "6.4.11.4 (b)" with "6.4.11.5 (b)".

6.4.23.17 (former 6.4.23.14) (t), replace "quality assurance programme" with "management system".

6.4.23.18 Insert a new paragraph 6.4.23.18 to read as follows:

"6.4.23.18 Each certificate issued by a competent authority for alternative activity limits for an exempt consignment of instruments or articles according to 5.1.5.2.1.4 shall include the following information:

- (a) Type of certificate;
- (b) The competent authority identification mark;
- (c) The issue date and an expiry date;
- (d) List of applicable national and international regulations, including the edition of the IAEA Regulations for the Safe Transport of Radioactive Material under which the exemption is approved;
- (e) The identification of the instrument or article;
- (f) A description of the instrument or article;
- (g) Design specifications for the instrument or article;
- (h) A specification of the radionuclide(s), the approved alternative activity limit(s) for the exempt consignment(s) of the instrument(s) or article(s);

- (i) Reference to documentation that demonstrates compliance with 2.7.2.2.2.2;
- (j) If deemed appropriate by the competent authority, reference to the identity of the applicant;
- (k) Signature and identification of the certifying official."

Current paragraphs 6.4.23.15 and 6.4.23.16 become 6.4.23.19 and 6.4.23.20 respectively.

#### **6.4.24 Transitional measures for class 7**

6.4.24.1 Amend to read as follows:

"Packages not requiring competent authority approval of design (excepted packages, Type IP-1, Type IP-2, Type IP-3 and Type A packages) shall meet these Regulations in full, except that packages that meet the requirements of the 1985 or 1985 (as amended 1990) Editions of IAEA Regulations for the Safe Transport of Radioactive Material (IAEA Safety Series No.6):

- (a) May continue in transport provided that they were prepared for transport prior to 31 December 2003, and subject to the requirements of 6.4.24.4, if applicable;
- (b) May continue to be used provided that:
  - (i) They were not designed to contain uranium hexafluoride;
  - (ii) The applicable requirements of 1.5.3.1 of this Code are applied;
  - (iii) The activity limits and classification in Chapter 2.7 of these Regulations are applied;
  - (iv) The requirements and controls for transport in Parts 1, 3, 4, 5 and 7 of this Code are applied;
  - (v) The packaging was not manufactured or modified after 31 December 2003."

6.4.24.2 Amend to read as follows:

"6.4.24.2 Packages requiring competent authority approval of the design shall meet the provisions of this Code in full unless the following conditions are met:

- (a) The packagings were manufactured to a package design approved by the competent authority under the provisions of the 1973 or 1973 (as amended) or the 1985 or 1985 (as amended 1990) Editions of IAEA Safety Series No.6);
- (b) The package design is subject to multilateral approval;
- (c) The applicable requirements of 1.5.3.1 of this Code are applied;

- (d) The activity limits and classification in Chapter 2.7 of this Code are applied;
- (e) The requirements and controls for transport in in Parts 1, 3, 4, 5 and 7 of this Code are applied;
- (f) For a package containing fissile material and transported by air, the requirement of 6.4.11.11 is met;
- (g) For packages that meet the requirements of the 1973 or 1973 (as amended) Editions of IAEA Safety Series No. 6:
  - (i) The packages retain sufficient shielding to ensure that the radiation level at 1 m from the surface of the package would not exceed 10 mSv/h in the accident conditions of transport defined in the 1973 Revised or 1973 Revised (as amended) Editions of IAEA Safety Series No.6 with the maximum radioactive contents which the package is authorized to contain;
  - (ii) The packages do not utilize continuous venting;
  - (iii) A serial number in accordance with the provision of 5.2.1.5.5 is assigned to and marked on the outside of each packaging."

6.4.24.3 Amend to read as follows:

"No new manufacture of packagings to a package design meeting the provisions of the 1973, 1973 (as amended), 1985, and 1985 (as amended 1990) Editions of IAEA Safety Series No.6 shall be permitted to commence."

6.4.24.4 Insert a new paragraph to read as follows:

"6.4.24.4 Packages excepted from the requirements for fissile materials under the Regulations annexed to the 16th revised edition or the seventeenth revised edition of the United Nations Recommendations on the Transport of Dangerous Goods (2009 Edition of IAEA Safety Standard Series No.TS-R-1)

6.4.24.4 Packages containing fissile material that is excepted from classification as "FISSILE" according to 2.7.2.3.5.1 (i) or (iii) of the IMDG Code amendment 35-10) or amendment 36-12, (paragraphs 417 (a) (i) or (iii) of the 2009 Edition of IAEA Regulations for the Safe Transport of Radioactive Material) prepared for transport before 31 December 2014 may continue in transport and may continue to be classified as non-fissile or fissile-excepted except that the consignment limits in table 2.7.2.3.5 of these editions shall apply to the conveyance. The consignment shall be transported under exclusive use."

and current paragraph 6.4.24.4 becomes new 6.4.24.5.

6.4.24.5 (former 6.4.24.4) In the first sentence, replace "programme of quality assurance" with "management system". Replace the last sentence with the following: "No new manufacture of such special form radioactive material shall be permitted to commence."

## Chapter 6.5 – Provisions for the construction and testing of intermediate bulk containers (IBCs)

### 6.5.2 Marking

#### 6.5.2.2 Additional marking

Amend 6.5.2.2.2 to read as follows:

"6.5.2.2.2 The maximum permitted stacking load applicable when the IBC is in use shall be displayed on a symbol as shown in the figures below. The symbol shall be durable and clearly visible.

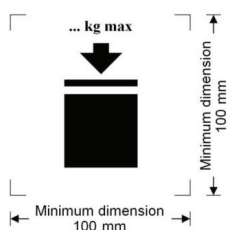

IBCs capable of being stacked

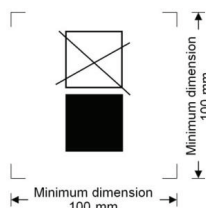

IBCs NOT capable of being stacked

The minimum dimensions shall be 100 mm x 100 mm. The letters and numbers indicating the mass shall be at least 12 mm high. The area within the printer's marks indicated by the dimensional arrows shall be square. Where dimensions are not specified, all features shall be in approximate proportion to those shown. The mass marked above the symbol shall not exceed the load imposed during the design type test (see 6.5.6.6.4) divided by 1.8.

**NOTE:** The provisions of 6.5.2.2.2 shall apply to all IBCs manufactured, repaired or remanufactured as from 1 January 2011. The provisions of 6.5.2.2.2 of the IMDG Code (Amendment 36-12) may continue to be applied to all IBCs manufactured, repaired or remanufactured between 1 January 2011 and 31 December 2016."

6.5.2.2.4 After "The date of the manufacture of the plastics inner receptacle may alternatively be marked on the inner receptacle adjacent to the remainder of the marking." add the following new sentence: "In such a case, the two digits of the year in the primary marking and in the inner circle of the clock shall be identical.". At the end, add a new "Note" to read as follows:

**"Note:** Other methods that provide the minimum required information in a durable, visible and legible form are also acceptable."



## Chapter 6.6 – Provisions for the construction and testing of large packagings

### 6.6.2 Code for designating types of large packagings

6.6.2.2 At the beginning, replace "The letter "W"" with "The letters "T" or "W"" and insert a new second sentence to read as follows: "The letter "T" signifies a large salvage packaging conforming to the requirements of 6.6.5.1.9."

### 6.6.3 Marking

6.6.3.2 Insert a new second example to read as follows:

"  50AT/Y/05/01/B/PQRS For a large steel salvage packaging suitable for  
2500/1000 stacking; stacking load: 2 500 kg; maximum gross  
mass: 1,000 kg."

Amend 6.6.3.3 to read as follows:

"6.6.3.3 The maximum permitted stacking load applicable when the large packaging is in use shall be displayed on a symbol as shown in the figures below. The symbol shall be durable and clearly visible.

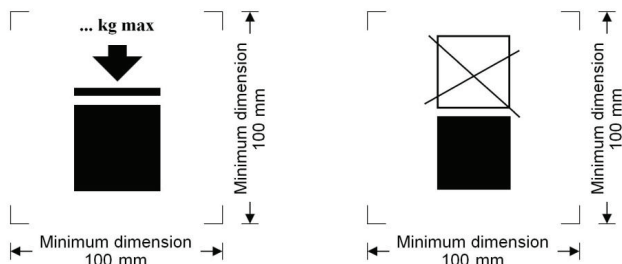

Large packagings capable of being stacked

Large packagings NOT capable of being stacked

The minimum dimensions shall be 100 mm x 100 mm. The letters and numbers indicating the mass shall be at least 12 mm high. The area within the printer's marks indicated by the dimensional arrows shall be square. Where dimensions are not specified, all features shall be in approximate proportion to those shown. The mass marked above the symbol shall not exceed the load imposed during the design type test (see 6.6.5.3.3.4) divided by 1.8.

**"NOTE:** The provisions of 6.6.3.3 shall apply to all large packagings manufactured, repaired or remanufactured as from 1 January 2015. The provisions of 6.6.3.3 of the IMDG Code (Amendment 36-12) may continue to be applied to all IBCs manufactured, repaired or remanufactured between 1 January 2015 and 31 December 2016."

## 6.6.5 Test provisions for large packagings

### 6.6.5.1 Performance and frequency of test

6.6.5.1.9 Insert the following new paragraph to read as follows:

*"6.6.5.1.9 Large salvage packagings*

Large salvage packagings shall be tested and marked in accordance with the provisions applicable to packing group II large packagings intended for the transport of solids or inner packagings, except as follows:

- (a) The test substance used in performing the tests shall be water, and the large salvage packagings shall be filled to not less than 98% of their maximum capacity. It is permissible to use additives, such as bags of lead shot, to achieve the requisite total package mass so long as they are placed so that the test results are not affected. Alternatively, in performing the drop test, the drop height may be varied in accordance with 6.6.5.3.4.4.2 (b);
- (b) Large salvage packagings shall, in addition, have been successfully subjected to the leakproofness test at 30 kPa, with the results of this test reflected in the test report required by 6.6.5.4; and
- (c) Large salvage packagings shall be marked with the letter "T" as described in 6.6.2.2."

## Chapter 6.7 – Provisions for the design, construction, inspection and testing of portable tanks and multiple-element gas containers (ME GCs)

### 6.7.2 Provisions for the design, construction, inspection and testing of portable tanks intended for the transport of substances of class 1 and classes 3 to 9

6.7.2.20.2, 6.7.3.16.2 and 6.7.5.13.2 Replace "shall be marked" with "shall be durably marked".

### 6.7.5 Provisions for the design, construction, inspection and testing of multiple-element gas containers (MEGCs) intended for the transport of non-refrigerated gases

6.7.5.2.4.1 Replace "ISO 11114-1:1997" with "ISO 11114-1:2012".

## Chapter 6.9 - Provisions for the design, construction, inspection and testing of bulk containers

6.9.4.6 Delete the footnote "\*" assigned to BK, and insert the following note at the end:

**Note:** "(x)" shall be replaced with "1" or "2", as appropriate.

**PART 7**  
**PROVISIONS CONCERNING TRANSPORT OPERATIONS**

**Chapter 7.1 – General stowage provisions**

**7.1.3 Stowage categories**

**7.1.3.1 Stowage categories for class 1**

7.1.3.1 In the paragraph replace the words "column 16" with "16a".

**7.1.3.2 Stowage categories for classes 2 to 9**

7.1.3.2 In the paragraph replace the words "column 16" with "16a".

**7.1.4 Special stowage provisions**

**7.1.4.1 Stowage of empty uncleaned packagings, including IBCs and large packagings**

7.1.4.1 In the paragraph replace the words "column 16" with "16a"

**7.1.4.5 Stowage of goods of class 7**

7.1.4.5.2 Replace "approval certificate" with "certificate of approval".

7.1.4.5.3.1 In the table amend the two first rows under the heading to read as follows:

Freight container	
Small freight container	50
Large freight container	50

and in the note "a" to the table, replace "7.1.4.5.6" with "7.1.4.5.5".

7.1.4.5.3.4 In the table amend the two first rows under the heading to read as follows:

Freight container		
Small freight container	50	n.a
Large freight container	50	100

Amend the end of note "b" to the table to read as follows: "... and stowed so as to maintain a spacing of at least 6 m from other groups."

and amend the end of the first sentence of note "c" to the table to read as follows: "... and stowed so as to maintain a spacing of at least 6 m from other groups."

7.1.4.5.10 Amend the end of the paragraph to read as follows:

"... and shall not be re-used unless the following conditions are fulfilled:

- .1 the non-fixed contamination shall not exceed the limits specified in 4.1.9.1.2;

- .2 the radiation level resulting from the fixed contamination shall not exceed 5  $\mu$ Sv/h at the surface."

7.1.4.5.13.2 Delete " to the critical group".

#### 7.1.5 Stowage Codes

7.1.5 Insert a new 7.1.5 with the following:

#### "7.1.5 Stowage Codes

The stowage codes given in column 16a of the dangerous goods list are as specified below:

Stowage Code	Description
SW1	Protected from sources of heat.
SW2	Clear of living quarters.
SW3	Shall be transported under temperature control.
SW4	Surface ventilation is required to assist in removing any residual solvent vapour.
SW5	If under deck, stow in a mechanically ventilated space.
SW6	When stowed under-deck, mechanical ventilation shall be in accordance with SOLAS regulation II-2/19 (II-2/54) for flammable liquids with flashpoint below 23°C c.c.
SW7	As approved by the competent authorities of the countries involved in the shipment
SW8	Ventilation may be required. The possible need to open hatches in case of fire to provide maximum ventilation and to apply water in an emergency, and the consequent risk to the stability of the ship through flooding of the cargo spaces, shall be considered before loading.
SW9	Provide a good through ventilation for bagged cargo. Double strip stowage is recommended. The illustration in 7.6.2.7.2.3 shows how this can be achieved. During the voyage regular temperature readings shall be taken at varying depths in the hold and recorded. If the temperature of the cargo exceeds the ambient temperature and continues to increase, ventilation shall be closed down.

<b>Stowage Code</b>	<b>Description</b>
SW10	Unless carried in closed cargo transport units, bales shall be properly covered by tarpaulins or the like. Cargo spaces shall be clean, dry and free from oil or grease. Ventilator cowls leading into the cargo space shall have sparking-preventing screens. All other openings, entrances and hatches leading to the cargo space shall be securely closed. During temporary interruption of loading, when the hatch remains uncovered, a fire-watch shall be kept. During loading or discharge, smoking in the vicinity shall be prohibited and fire-fighting appliances kept ready for immediate operation.
SW11	Cargo transport units shall be shaded from direct sunlight. Packages in cargo transport units shall be stowed so as to allow for adequate air circulation throughout the cargo.
SW12	taking account of any supplementary requirements specified in the transport documents.
SW13	taking account of any supplementary requirements specified in the competent authority approval certificate(s).
SW14	Category A only if the special stowage provisions of 7.4.1.4 and 7.6.2.8.4 are complied with
SW15	For metal drums, stowage category B.
SW16	For unit loads in open cargo transport units, stowage category B.
SW17	Category E, for closed cargo transport unit and pallet boxes only. Ventilation may be required. The possible need to open hatches in case of fire to provide maximum ventilation and to apply water in an emergency, and the consequent risk to the stability of the ship through flooding of the cargo space, shall be considered before loading.
SW18	Category A, when transported in accordance with P650.
SW19	For batteries transported in accordance with SP 376 or SP 377 Category C, unless transported on a short international voyage.
SW20	For uranyl nitrate hexahydrate solution stowage category D applies.
SW21	For uranium metal pyrophoric and thorium metal pyrophoric stowage category D applies.
SW22	For AEROSOLS with a maximum capacity of 1 litre: Category A. For AEROSOLS with a capacity above 1 litre: Category B. For WASTE AEROSOLS: Category C, Clear of living quarters.
SW23	When transported in BK3 bulk container, see 7.6.2.12 and 7.7.3.9.
SW24	For special stowage provisions see 7.4.1.3 and 7.6.2.7.2.

Stowage Code	Description
SW25	For special stowage provisions see 7.6.2.7.3.
SW26	For special stowage provisions see 7.4.1.4 and 7.6.2.11.1.1.
SW27	For special stowage provisions see 7.6.2.7.2.1.
SW28	As approved by the competent authority of the country of origin.

### 7.1.6 Handling Codes

7.1.6 Insert a new 7.1.6 with the following:

#### "7.1.6 Handling Codes

The handling codes given in column 16a of the dangerous goods list are as specified below:

Handling Codes	Description
H1	Keep as dry as reasonably practicable
H2	Keep as cool as reasonably practicable
H3	During transport, it should be stowed (or kept) in a cool ventilated place
H4	If cleaning of cargo spaces has to be carried out at sea, the safety procedures followed and standard of equipment used shall be at least as effective as those employed as industry best practice in a port. Until such cleaning is undertaken, the cargo spaces in which the asbestos has been carried shall be closed and access to those spaces shall be prohibited.

## Chapter 7.2 – General segregation provisions

### 7.2.3 Segregation provisions

7.2.3.1 In the paragraph, replace twice the words "column 16" with "column 16b".

7.2.3.4 In the paragraph, replace the words "column 16" with "column 16b".

### 7.2.4 Segregation table

in the row "Flammable gases 2.1" versus column of class 4.3 replace "X" with "2".

in the row "Flammable liquid 3" versus column of class 4.3 replace "1" with "2".

in the row "Substances which, in contact with water, emit flammable gases 4.3" versus column 2.1 replace "X" with "2".

in the row "Substances which, in contact with water, emit flammable gases 4.3" versus column 3 replace "1" with "2".

**7.2.5 Segregation groups**

7.2.3.1 In the paragraph, replace the words "column 16 (stowage and segregation)" with "column 16b"

**7.2.6 Special segregation provisions and exemptions**

7.2.6.4 In the paragraph, replace the words "column 16" with "column 16b". and in "examples" replace "column 16" with "column 16b".

**7.2.8 Segregation Codes**

7.2.8 Insert a new 7.2.8 with the following:

**"7.2.8 Segregation Codes**

The segregation codes given in column 16b of the dangerous goods list are as specified below:

<b>Segregation Codes</b>	<b>Description</b>
SG1	For packages carrying a subsidiary risk of class 1, segregation as for class 1, division 1.3.
SG2	Segregation as for class 1.2G
SG3	Segregation as for Class 1.3G
SG4	Segregation as for class 2.1
SG5	Segregation as for class 3
SG6	Segregation as for class 5.1
SG7	Stow "away from" class 3
SG8	Stow "away from" class 4.1
SG9	Stow "away from" class 4.3
SG10	Stow "away from" class 5.1
SG11	Stow "away from" class 6.2
SG12	Stow "away from" class 7
SG13	Stow "away from" class 8

Segregation Codes	Description
SG14	Stow "separated from" class 1 except for division 1.4S
SG15	Stow "separated from" class 3
SG16	Stow "separated from" class 4.1
SG17	Stow "separated from" class 5.1
SG18	Stow "separated from" class 6.2
SG19	Stow "separated from" class 7
SG20	Stow "away from" acids
SG21	Stow "away from" alkalis
SG22	Stow "away from" ammonium salts
SG23	Stow "away from" animal or vegetable oils
SG24	Stow "away from" azides
SG25	Stow "separated from" goods of classes 2.1 and 3.
SG26	In addition: from goods of classes 2.1 and 3 when stowed on deck of a containership a minimum distance of two container spaces athwartship shall be maintained, when stowed on ro-ro ships a distance of 6 m athwartship shall be maintained.
SG27	Stow "away from" explosives containing chlorates or perchlorates
SG28	Stow "away from" ammonium compounds and explosives containing ammonium compounds or salts
SG29	Segregation from foodstuffs as in 7.3.4.2.2, 7.6.3.1.2 or 7.7.3.7.
SG30	Stow "away from" heavy metals and their salts
SG31	Stow "away from" lead and its compounds
SG32	Stow "away from" liquid halogenated hydrocarbons
SG33	Stow "away from" powdered metals
SG34	When containing ammonium compounds, "away from" chlorates or perchlorates and explosives containing chlorates or perchlorates.
SG35	Stow "separated from" acids.



Segregation Codes	Description
SG36	Stow "separated from" alkalis.
SG37	Stow "separated from" ammonia.
SG38	Stow "separated from" ammonium compounds.
SG39	Stow "separated from" ammonium compounds other than AMMONIUM PERSULPHATE (UN 1444).
SG40	Stow "separated from" ammonium compounds other than mixtures of ammonium persulphates and/or potassium persulphates and/or sodium persulphates.
SG41	Stow "separated from" animal or vegetable oil.
SG42	Stow "separated from" bromates.
SG43	Stow "separated from" bromine.
SG44	Stow "separated from" CARBON TETRACHLORIDE (UN 1846).
SG45	Stow "separated from" chlorates.
SG46	Stow "separated from" chlorine.
SG47	Stow "separated from" chlorites.
SG48	Stow "separated from" combustible material (particularly liquids). Combustible material does not include packing materials or dunnage.
SG49	Stow "separated from" cyanides
SG50	Segregation from foodstuffs as in 7.3.4.2.1, 7.6.3.1.2 or 7.7.3.6.
SG51	Stow "separated from" hypochlorites
SG52	Stow "separated from" iron oxide
SG53	Stow "separated from" liquid organic substances
SG54	Stow "separated from" mercury and mercury compounds
SG55	Stow "separated from" mercury salts
SG56	Stow "separated from" nitrites
SG57	Stow "separated from" odour-absorbing cargoes

Segregation Codes	Description
SG58	Stow "separated from" perchlorates
SG59	Stow "separated from" permanganates
SG60	Stow "separated from" peroxides
SG61	Stow "separated from" powdered metals
SG62	Stow "separated from" sulphur
SG63	Stow "separated longitudinally by an intervening complete compartment or hold from" Class 1.
SG64	<i>Reserved</i>
SG65	Stow "separated by a complete compartment or hold from" class 1 except for division 1.4.
SG66	<i>Reserved</i>
SG67	Stow "separated from" division 1.4 and "separated longitudinally by an intervening complete compartment or hold from" divisions 1.1, 1.2, 1.3, 1.5 and 1.6 except from explosives of compatibility group J.
SG68	If flashpoint 60°C c.c. or below, segregation as for class 3, but "away from" class 4.1.
SG69	For AEROSOLS with a maximum capacity of 1 litre: Segregation as for class 9. Stow "separated from" class 1 except for division 1.4. For AEROSOLS with a capacity above 1 litre: Segregation as for the appropriate subdivision of class 2. For WASTE AEROSOLS: Segregation as for the appropriate subdivision of class 2.
SG70	For arsenic sulphides, "separated from" acids
SG71	Within the appliance, to the extent that the dangerous goods are integral parts of the complete life-saving appliance, there is no need to apply the provisions on segregation of substances in chapter 7.2.
SG72	See 7.2.6.3.2.
SG73	<i>Reserved</i>
SG 74	Segregation as for 1.4G.
SG 75	Stow "separated from" strong acids.

## **Annex** **Segregation flow chart**

In the boxes, replace the words "column 16" with "column 16b",

### **Chapter 7.3 – Consigning operations concerning the packing and use of cargo transport units (CTUs) and related provisions**

#### **7.3.2 General provisions for cargo transport units**

7.3.2.2 In the paragraph delete reference to footnote "\*\* See IMO publication, sales number IB282E"

#### **7.3.3 Packing of cargo transport units**

7.3.3.1 The existing paragraph "7.3.3.1" is renumbered as "7.3.3.2".

7.3.3.1 Insert a new "7.3.3.1" with the following:

"7.3.3.1 Prior to the use of a cargo transport unit it shall be checked to ensure that it is apparently fit for its intended purpose\*."

and add the corresponding footnote as follows:

\*\* For safety approval plates and maintenance and examination of containers see the International Convention for Safe Containers, 1972, as amended annex I regulations 1 and 2 (see 1.1.2.3)."

7.3.3.2 The existing "7.3.3.2" is renumbered as "7.3.3.3", and at the end, the following new sentence is added:

"Whenever the handling provision "keep as dry as reasonably practicable" (H1) is assigned in column (16a) of the dangerous goods list, the cargo transport unit including any contained goods, securing or packing materials shall be kept as dry as reasonably practicable."

#### **7.3.4.2 Segregation in relation to foodstuffs**

7.3.4.2.1 In the paragraph, replace the words "column 16" with "column 16b".

7.3.4.2.2 In subparagraph ".4", replace the words "column 16" with "column 16b".

#### **7.3.7 Cargo transport units under temperature control**

##### **7.3.7.2 General provisions**

7.3.7.2.4 Replace existing paragraph with the following:

"7.3.7.2.4 Prior to the use of cargo transport unit, the refrigeration system shall be subjected to a thorough inspection and a test to ensure that all parts are functioning properly.

7.3.7.2.4.1 Refrigerant gas shall only be replaced in accordance with the manufacturer's operating instructions for the refrigeration system. Prior to filling replacement refrigerant gas, a certificate of analysis from the supplier shall be obtained and checked to confirm that the



Bilaga 3 – Förteckning över läkemedel och medicinsk utrustning

Nedan anges de läkemedel och den medicinska utrustning som enligt 7 § i dessa föreskrifter ska finnas ombord på fartyg.

I nedanstående tabeller visas de fastställda minimikraven för:

- Kolumn A Fartyg med mer än 24 timmar till anlöpbar hamn där fullvärdig behandling kan ges.  
Kolumn B Fartyg som kan nå anlöpbar hamn där fullvärdig behandling kan ges inom 24 timmar.  
Kolumn C Fartyg som kan nå anlöpbar hamn där fullvärdig behandling kan ges inom 2 timmar.

Läkemedel *	Beredningsform	Exempel †	Fastställd minimikvantitet		
			A	B	C
Amoxicillin	kapslar 500 mg	Amoxicillin Scand Pharm	30 kapslar	Inga	Inga
Antibiotisk ögonsalva	Ögonsalva	Chloromycetin, ögonsalva 1%	5 tuber	5 tuber	Inga
Atropin	Injektionsvätska 0.5 mg/ml (1 ml ampull)	Atropin NM Pharma	30×1 ml	30×1 ml	Inga
Beclometason inkl. andningsbehållare, typ Volumatic eller	Inhalationsspray 50 µg/dos (200 doser) eller 250 µg/dos (200 doser)	Becotide	5 × 200 doser	5 × 200 doser	Inga
Budesonid inkl. andningsbehållare, typ Volumatic	Inhalationspulver 200 µg/dos (100 doser)	Pulmicort Turbuhaler	5 × 100 doser	5 × 100 doser	Inga
Bedövande ögondroppar	Ögondroppar, endospipetter 0.5 ml (20×0.5 ml)	Tetrakain, ögondroppar 1 %	1 förpackning	1 förpackning	1 förpackning
Cefuroxim	Injektionssubstans 750 mg (injektionsflaskor 750 mg)	Cefuroxim Norcox	10 × 750 mg	Inga	Inga
Diazepam	Klymsa eller rektalvätska 10 mg	Diazepam Desitin, klymsa 10 mg eller Stesolid, Rektalvätska 10 mg	5 × 10 mg	5 × 10 mg	Inga
Erytromycin	Tabletter 500 mg	Abboticin Novum	30 × 500 mg	Inga	Inga
Etylalkohol	Lösning 99.5 %		3 × 500 ml	1 × 500 ml	Inga <sup>x</sup>
Fluorescein	Ögondroppar, lösning 2%. Endospipetter (20 × 0.5 ml)	Fluoresceinnatrium	1 förpackning	Inga	Inga
Furosemid	Injektionslösning 10 mg/ml (4 ml ampull)	Furix, Injektionslösning 10 mg/ml eller Furosemid NM Pharma	5 × 4 ml	Inga	Inga
Fytomenadion	Injektionsvätska 10mg/ml (1 ml ampull)	Konaktion Novum	10 × 1 ml	Inga	Inga
Kalciumglukonat	Brustabletter 1 g	Calcium-Sandoz	20 tabletter	20 tabletter	Inga
Kalciumglukonat gel	Gel 2.5 % (25 g tub)	HF Antidote Gel	5 tuber	5 tuber	5 tuber
Kol, medicinskt alternativt aktivt	Pulver (50 g flaska) eller brusgranulat (5 g portionspåse)	Carbomix eller Medikol	2 × 50 g eller 10 × 5 g	2 × 50 g eller 10 × 5 g	Inga
Metoklopramid	Injektionsvätska 5 mg/ml (2 mg ampull)	Primperan	30 × 2 ml	10 × 2 ml	5 × 2 ml
Metronidazol	Suppositorier 1 g	Elyzol eller Flagyl	10 × 1 g	Inga	Inga
Morfin	Injektionsvätska 10 mg/ml (1ml ampull)	Morfin	40 × 1 ml	10 × 1 ml	5 × 1 ml
Naloxon	Injektionsvätska 0.4 mg/ml (1 ml ampull)	Narcanti	10 × 1 ml	10 × 1 ml	10 × 1 ml
Natriumklorid, isoton	Spolvätska 9 mg/ml (0.9%) (flaska 1 liter)		5 × 1 liter	3 × 1 liter	1 × 1 liter
Oral vätskeersättning	Dospåsar eller tabletter som löses i vatten	Resorb eller Semper vätskeersättning	För 18 liter lösning	För 6 liter lösning	Inga

\* De förtecknade läkemedlen ska användas efter anvisning från Radio Medical. Etikettering, förvaring och fördelning av läkemedel ska i allmänhet vara i enlighet med IMGS (International Medical Guide for Ships). Innehållet och förvaringsförhållanden ska kontrolleras minst en gång per år med beaktande av tillverkarens angivna utgångsdatum och förvaringsinstruktioner. Förbrukade läkemedel ska ersättas så snart som möjligt.

† Angivna läkemedel är endast exempel. Det kan finnas motsvarande läkemedel från andra tillverkare med andra handelsnamn.

## Bilaga 3 – Förteckning över läkemedel och medicinsk utrustning

Läkemedel *	Beredningsform	Exempel †	Fastställd minimikvantitet		
			A	B	C
Paracetamol	Tabletter 500 mg	Alvedon, Panodil	200 tabletter	100 tabletter	20 tabletter
Plasmaersättningsmedel på gelatinbas	Infusionsvätska (flaska 500 ml)	Haemaccel	3 × 500 ml	3 × 500 ml	Inga
Salbutamol inkl. andningsbehållare, typ Volumatic eller Terbutalin inkl. andningsbehållare, typ Volumatic	Inhalationsareosol 100 µg/dos (200 doser) eller Inhalationspulver 500 µg/dos (200 doser)	Salbutamol NM Pharma  Bricanyl Turbuhaler	5 × 200 doser  5 × 200 doser	5 × 200 doser  5 × 200 doser	1 × 200 doser  1 × 200 doser
Sterilt vatten	För beredning av injektionslösning (ampull 10 ml)	Sterilt vatten	20 × 10 ml	Inga	Inga

Utrustning	Fastställd minimikvantitet		
	A	B	C
Svalgtub storlek 2 storlek 3 storlek 4	2 2 2	2 2 2	2 2 2
Infusionskanyl, typ Venflon, 1.2 mm (grön)	10	10	Inga
Infusionsaggregat	10	10	Inga
Kanyl 0,8 mm, engångs med Luerfättning	100	50	10
Engångsmask för syrgasadministration med kapacitet upp till 60% syrgas	10	10	2
Andningsballong (typ Rubens)	2	2	2
Syrgascylinder	40 liter/200 bar**	40 liter/200 bar**	Inga
Portabel utrustning för syrgasbehandling avsedd för omedelbart bruk	1** (2 liter/200 bar)	1** 2 liter/200 bar)	1
Extra syrgascylinder i reserv	1** (2 liter/200 bar)	1** (2 liter/200 bar)	1
Injektionsspruta, engångs med Luerfättning 2 ml 5 ml	100 10	50 10	10 Inga

\*\* Minst 44 liter/200 bar andningsoxygen (syrgas) som ska bestå av minst följande:

1. En komplett portabel utrustning med cylinder 2 liter/200 bar syrgas klar för omedelbar användning samt en cylinder med 2 liter/200 bar i reserv.
2. En syrgascylinder med 40 liter/200 bar andningsoxygen (syrgas) (i fartygets sjukhytt monterad för omedelbart bruk) med en regulator som kan förse två personer samtidigt med syrgas. Om mer än en ej flyttbar syrgascylinder används så måste det finnas två regulatorer som kan förse två personer samtidigt med syrgas.